

**Instruction manual
Manual de
Instrucciones
Manuel d'instructions**

**ESPAÑOL: PÁGINA 9
FRANÇAIS: PAGE 17**

**1/2" Impact Wrench
Herramienta
Neumática de Impacto,
de 1/2"
Clé à chocs de 1/2 po**



**MODEL PT502
MODELO PT502
MODÈLE PT502**

To learn more about Porter-Cable visit
our website at:

<http://www.porter-cable.com>

Para obtener más información sobre
Porter-Cable, visite nuestro sitio web en:

<http://www.porter-cable.com>

Pour de plus amples renseignements
concernant Porter-Cable, consultez
notre site Web à l'adresse suivante:

<http://www.porter-cable.com>

PORTER-CABLE

IMPORTANT

*Please make certain that the person who is
to use this equipment carefully reads and
understands these instructions before
starting operations.*

IMPORTANTE

*Asegúrese de que la persona que va a usar esta
herramienta lea cuidadosamente y comprenda
estas instrucciones antes de empezar a
operarla.*

IMPORTANT

*Veillez vous assurer que la personne qui
utilise cet outil lit attentivement et comprend
ces instructions avant de commencer à utiliser
l'outil.*

Copyright © 2002 Porter-Cable Corporation

SAFETY GUIDELINES - DEFINITIONS

This manual contains information that is important for you to know and understand. This information relates to protecting YOUR SAFETY and PREVENTING EQUIPMENT PROBLEMS. To help you recognize this information, we use the symbols below. Please read the manual and pay attention to these sections.

⚠ DANGER

indicates an imminently hazardous situation which, if not avoided, will result in death or serious injury.

⚠ WARNING

indicates a potentially hazardous situation which, if not avoided, could result in death or serious injury.

⚠ CAUTION

indicates a potentially hazardous situation which, if not avoided, may result in minor or moderate injury

CAUTION

used without the safety alert symbol indicates potentially hazardous situation which, if not avoided, may result in property damage.

⚠ WARNING Some dust created by power sanding, sawing, grinding, drilling, and other construction activities contains chemicals known (to the State of California) to cause cancer, birth defects or other reproductive harm. Some example of these chemicals are:

- lead from lead-based paints
- crystalline silica from bricks and cement and other masonry products
- arsenic and chromium from chemically-treated lumber

Your risk from these exposures varies, depending on how often you do this type of work. To reduce your exposure to these chemicals: work in a well ventilated area, and work with approved safety equipment, always wear MSHA/NIOSH approved, properly fitting face mask or respirator when using such tools.

When using air tools, basic safety precautions should always be followed to reduce the risk of personal injury.

IMPORTANT SAFETY INSTRUCTIONS





⚠ WARNING IMPROPER OPERATION OR MAINTENANCE OF THIS PRODUCT COULD RESULT IN SERIOUS INJURY AND PROPERTY DAMAGE. READ AND UNDERSTAND ALL WARNINGS AND OPERATING INSTRUCTIONS BEFORE USING THIS EQUIPMENT. WHEN USING AIR TOOLS, BASIC SAFETY PRECAUTIONS SHOULD ALWAYS BE FOLLOWED TO REDUCE THE RISK OF PERSONAL INJURY.

SAVE! IMPORTANT SAFETY INSTRUCTIONS SAVE!

HAZARD	
<p>⚠ WARNING RISK OF EYE OR HEAD INJURY</p>	
WHAT COULD HAPPEN	HOW TO PREVENT IT
<ul style="list-style-type: none"> • Air powered equipment and power tools are capable of propelling materials such as fasteners, metal chips, saw dust, and other debris at high speed, which could result in serious eye injury. • Compressed air can be hazardous. The air stream can cause injury to soft tissue areas such as eyes, ears, etc. Particles or objects propelled by the stream can cause injury. • Tool attachments can become loose or break and fly apart propelling particles at the operator and others in the work area. 	<ul style="list-style-type: none"> • Always wear ANSI approved Z87.1 safety glasses with side shields. • Never leave operating tool unattended. Disconnect air hose when tool is not in use. • For additional protection use an approved face shield in addition to safety glasses. • Make sure that any attachments are securely assembled.

HAZARD	
<p>⚠ WARNING RISK OF FIRE OR EXPLOSION</p>	
WHAT COULD HAPPEN	HOW TO PREVENT IT
<ul style="list-style-type: none"> • Abrasive tools such as sanders and grinders, rotating tools such as drills, and impact tools such as nailers, staplers, wrenches, hammers, and reciprocating saws are capable of generating sparks which could result in ignition of flammable materials. • Exceeding the maximum pressure rating of tools or accessories could cause an explosion resulting in serious injury. 	<ul style="list-style-type: none"> • Never operate tools near flammable substances such as gasoline, naphtha, cleaning solvents, etc. • Work in a clean, well ventilated area free of combustible materials. • Never use oxygen, carbon dioxide or other bottled gases as a power source for air tools. • Use compressed air regulated to a maximum pressure at or below the rated pressure of any attachments. • Never connect to an air source that is capable of exceeding 200 psi. • Always verify prior to using the tool that the air source has been adjusted to the rated air pressure range.

HAZARD		
▲WARNING RISK OF LOSS OF HEARING		
WHAT COULD HAPPEN	HOW TO PREVENT IT	
<ul style="list-style-type: none"> Long term exposure to noise produced from the operation of air tools can lead to permanent hearing loss. 	<ul style="list-style-type: none"> Always wear ANSI S3.19 hearing protection. 	

HAZARD		
▲WARNING RISK TO BREATHING INHALATION HAZARD		
WHAT COULD HAPPEN	HOW TO PREVENT IT	
<ul style="list-style-type: none"> Abrasive tools, such as grinders, sanders, and cut-off tools generate dust and abrasive materials which can be harmful to human lungs and respiratory system. Some materials such as adhesives and tar, contain chemicals whose vapors could cause serious injury with prolonged exposure. 	<ul style="list-style-type: none"> Always wear MSHA/NIOSH approved, properly fitting face mask or respirator when using such tools. Always work in a clean, dry, well ventilated area. 	

HAZARD		
▲WARNING RISK OF INJURY		
WHAT COULD HAPPEN	HOW TO PREVENT IT	
<ul style="list-style-type: none"> Tools left unattended, or with the air hose attached can be activated by unauthorized persons leading to their injury or injury to others. Air tools can propel fasteners or other materials throughout the work area. A wrench or a key that is left attached to a rotating part of the tool increases the risk of personal injury. Using inflator nozzles for duster applications can cause serious injury. Air tools can become activated by accident during maintenance or tool changes. Air tools can cause the workpiece to move upon contact leading to injury. Loss of control of the tool can lead to injury to self or others. Poor quality, improper, or damaged tools such as grinding wheels, chisels, sockets, drills, nailers, staplers, etc., can fly apart during operation, propelling particles throughout the work area causing serious injury. Fasteners could ricochet or be propelled causing serious injury or property damage. 	<ul style="list-style-type: none"> Remove air hose when tool is not in use and store tool in secure location away from reach of children and or untrained users. Use only parts, fasteners, and accessories recommended by the manufacturer. Keep work area clean and free of clutter. Keep children and others away from work area during operation of the tool. Keep work area well lit. Remove adjusting keys and wrenches before turning the tool on. DO NOT use inflator nozzles for duster applications. Remove air hose to lubricate or add grinding attachments, sanding discs, drills, etc. to the tool. Never carry the tool by the hose. Avoid unintentional starting. Don't carry hooked-up tool with finger on trigger. Repair servicing should be done only by an authorized service representative. Use clamps or other devices to prevent movement. Never operate tool while under the influence of drugs or alcohol. Don't overreach. Keep proper footing and balance at all times. Keep handles dry, clean, and free from oil and grease. Stay alert. Watch what you are doing. Use common sense. Do not operate tool when you are tired. Always use tool attachments rated for the speed of the power tool. Never use tools which have been dropped, impacted or damaged by use. Use only impact grade sockets on an impact wrench. Do not apply excessive force to the tool, let the tool perform the work. Never point discharge of tool at self or others. Do not pull trigger unless tool contact safety device is against work surface. Never attempt to drive fasteners into hard surfaces such as steel, concrete, or tile. Take care to avoid driving a fastener on top of another fastener. Position tool carefully so that fasteners will be delivered to the proper location. 	

HAZARD	
▲WARNING RISK OF INJURY (continued)	
	
WHAT COULD HAPPEN	HOW TO PREVENT IT
<ul style="list-style-type: none"> Improperly maintained tools and accessories can cause serious injury. 	<ul style="list-style-type: none"> Maintain the tool with care. Keep a cutting tool sharp and clean. A properly maintained tool, with sharp cutting edges reduces the risk of binding and is easier to control.
<ul style="list-style-type: none"> There is a risk of bursting if the tool is damaged. 	<ul style="list-style-type: none"> Check for misalignment or binding of moving parts, breakage of parts, and any other condition that affects the tool's operation. If damaged, have the tool serviced before using.
<p>Use only accessories identified by the manufacturer to be used with specific tools.</p>	<ul style="list-style-type: none"> Use of an accessory not intended for use with the specific tools, increases the risk of injury to persons.

HAZARD	
▲WARNING RISK OF ELETRIC SHOCK	
	
WHAT COULD HAPPEN	HOW TO PREVENT IT
<ul style="list-style-type: none"> Using air tools to attach electrical wiring can result in electrocution or death. 	<ul style="list-style-type: none"> Never use nailer/staplers to attach electrical wiring while energized.
<ul style="list-style-type: none"> This tool is not provided with an insulated gripping surface. Contact with a "live" wire will also make exposed metal parts of the tool "live" and can result in electrocution or death. 	<ul style="list-style-type: none"> Avoid body contact with grounded surfaces such as pipes, radiators, ranges, and refrigerators. There is an increased risk of electric shock if your body is grounded.
<ul style="list-style-type: none"> Fasteners coming in contact with hidden electrical wiring could cause electrocution or death. 	<ul style="list-style-type: none"> Thoroughly investigate the workpiece for possible hidden wiring before performing work.

HAZARD	
▲WARNING RISK OF ENTANGLEMENT	
	
WHAT COULD HAPPEN	HOW TO PREVENT IT
<ul style="list-style-type: none"> Tools which contain moving elements, or drive other moving tools, such as grinding wheels, sockets, sanding discs, etc. can become entangled in hair, clothing, jewelry and other loose objects, resulting in severe injury. 	<ul style="list-style-type: none"> Never wear loose fitting clothes, or apparel which contains loose straps or ties, etc. which could become entangled in moving parts of the tool. Remove any jewelry, watches, identifications, bracelets, necklaces, etc. which might become caught by the tool. Keep hands away from moving parts. Tie up or cover long hair. Always wear proper fitting clothing and other safety equipment when using this tool.

HAZARD	
▲WARNING RISK OF CUT OR BURNS	
	
WHAT COULD HAPPEN	HOW TO PREVENT IT
<ul style="list-style-type: none"> Tools which cut, shear, drill, staple, punch, chisel, etc. are capable of causing serious injury. 	<ul style="list-style-type: none"> Keep the working part of the tool away from hands and body.

SPECIFICATIONS

Maximum Torque	500 ft./lbs
Blows Per Minute	1,000
Maximum Working Pressure	90 PSI
Air Inlet	1/4" NPT
Recommended Hose Size	3/8" I.D.
Air Consumption @ 90 PSI	4.2 SCFM

ASSEMBLY

Accessories Required

IMPORTANT: Line pressure or hose inside diameter should be increased to compensate for unusually long air hoses (over 25 feet). Minimum hose diameter should be 3/8" I.D. and fittings should have 1/4" NPT thread.

OPERATION

Operation

Before each use:

- Drain water from air compressor tank and condensation from air lines. See air compressor's operators manual.

CAUTION Disconnect the tool from the air supply before lubricating or changing sockets.

- Lubricate tool, see "Maintenance" section in this manual.

CAUTION Impact wrench sockets and accessories must be used with this tool. Do not use hand sockets and accessories.

- Select the required impact socket. This tool has a 1/2" square drive, use 1/2" deep sockets. Use 1/2" extensions only when needed.
- Connect tool to air hose of recommended size. **NOTE:** The use of a quick connect set makes connecting easier.
IMPORTANT: The use of air filters and air line lubricators is recommended.

To use:

- Turn air compressor on and allow air tank to fill.
- Set the air compressor's regulator to 90 PSI. This tool operates at a maximum **90 PSI** pressure.
- Set torque regulator, see chart, to set the desired setting to avoid over tightening.

IMPORTANT: These torque values can vary depending on the size of the air compressor and the cubic feet of air (SCFM) the air compressor delivers.

- Place tool in forward or reverse position. Place in "F" position for forward or "R" position for reverse.
- Depress the trigger to operate tool.
- Release trigger to stop tool.
- Always disconnect air supply when changing sockets.
- When job is complete, turn the air compressor off and store as described in the air compressor operator manual.

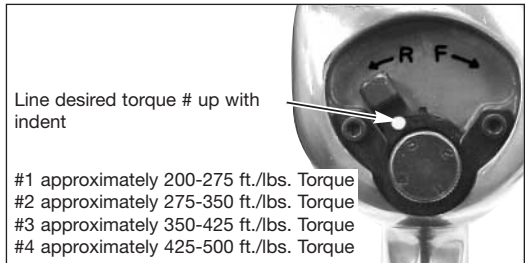

Lubrication

Air tools require lubrication throughout the life of the tool. The air motor and bearing uses compressed air to power the tool. Because moisture in compressed air will rust the air motor, you must lubricate the motor daily. An inline oiler is recommended.

To lubricate the air motor manually:

- Disconnect the tool from the air supply holding it so the air inlet faces up.
- Depress the trigger and place one to two drops of air tool oil in the air inlet. Depressing the trigger helps circulate oil in the motor. **NOTE:** Use SAE #10 weight oil if air tool oil is not available.
- Connect the tool to an air source, cover the exhaust end with a towel and run for a few seconds.



⚠ WARNING Any excess oil in the motor is immediately expelled from the exhaust port. Always direct exhaust port away from people or objects.

⚠ WARNING Failure to lubricate the tool at the air inlet will void your warranty.

REPAIR PARTS

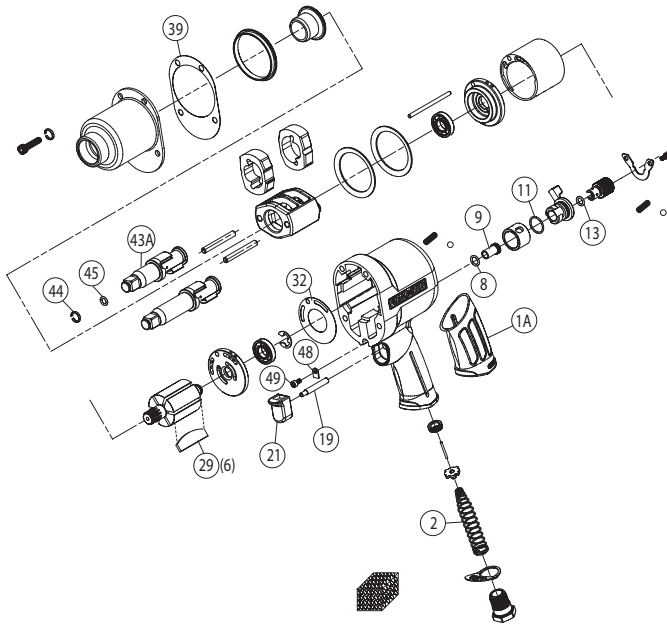

Ref

No.	Part No.	Description	Qty
1a	D25494	Handle Grip	1
2	u	Throttle Valve Spring	1
8	u	O-Ring	1
9	u	Air Valve	1
11	u	O-Ring	1
13	u	O-Ring	1
19	+	Trigger Pin	1
21	+	Trigger	1
29	u	Rotor Blade	6
32	u	End Plate Gasket	1
39	u	Hammer Case Gasket	1
43a	u	Standard Anvil	1
44	u	Socket Retainer	1
45	u	Retainer O-Ring	1
48	+ / u	Cap	1
49	+ / u	Screw	1

+ Only available in Trigger Repair Kit D25489

u Only available in Tune-Up Kit D26759

NOTE: Parts not listed are not serviceable.

LIMITED WARRANTY

PORTER-CABLE CORPORATION warrants to the original purchaser that all products covered under this warranty are free from defects in material and workmanship. Products covered under this warranty include air compressors, air tools, service parts, pressure washers, and generators, which have the following warranty periods:

- 3 YEARS** - Limited warranty on 2-stage oil-free air compressor pumps that operate at 1725 RPM.
- 2 YEARS** - Limited warranty on oil-lubricated air compressor pumps.
- 1 YEAR** - Limited warranty on all other air compressor components.
- 2 YEARS** - Limited warranty on electric generator alternators.
- 1 YEAR** - Limited warranty on other generator components.
- 2 YEARS** - Limited warranty on pneumatic air tools as described in Porter-Cable general catalog.
- 1 YEAR** - Limited warranty on pressure washers used in consumer applications (i.e. personal residential household usage only).
- 90 DAY** - Pressure washers used for commercial applications (income producing) and service parts.
- 1 YEAR** - Limited warranty on all accessories.

Porter-Cable will repair or replace, at **Porter-Cable's** option, products or components which have failed within the warranty period. Service will be scheduled according to the normal work flow and business hours at the service center location, and the availability of replacement parts. All decisions of **Porter-Cable** Corporation with regard to this limited warranty shall be final.

This warranty gives you specific legal rights, and you may also have other rights which vary from state to state.

RESPONSIBILITY OF ORIGINAL PURCHASER (initial User):

- To process a warranty claim on this product. DO NOT return it to the retailer. The product must be evaluated by an **Porter-Cable** Authorized Warranty Service Center. For the location of the nearest **Porter-Cable** Authorized Warranty Service Center call 1-888-559-8550, 24 hours a day, 7 days a week.
- Retain original cash register sales receipt as proof of purchase for warranty work.
- Use reasonable care in the operation and maintenance of the product as described in the Owners Manual(s).
- Deliver or ship the product to the nearest **Porter-Cable** Authorized Warranty Service Center. Freight costs, if any, must be paid by the purchaser.
- Air compressors with 60 and 80 gallon tanks will be inspected at the site of installation. Contact the nearest **Porter-Cable** Authorized Warranty Service Center that provides on-site service calls, for service call arrangements.
- If the purchaser does not receive satisfactory results from the **Porter-Cable** Authorized Warranty Service Center, the purchaser should contact Porter-Cable.

THIS WARRANTY DOES NOT COVER:

- Merchandise sold as reconditioned, used as rental equipment, and floor or display models.
- Merchandise that has become damaged or inoperative because of ordinary wear, misuse*, cold, heat, rain, excessive humidity, freeze damage, use of improper chemicals, negligence, accident, failure to operate the product in accordance with the instructions provided in the Owners Manual(s) supplied with the product, improper maintenance, the use of accessories or attachments not recommended by **Porter-Cable**, or unauthorized repair or alterations.
* An air compressor that pumps air more than 50% during a one hour period is considered misuse because the air compressor is undersized for the required air demand.
- Repair and transportation costs of merchandise determined not to be defective.
- Costs associated with assembly, required oil, adjustments or other installation and start-up costs.
- Expendable parts or accessories supplied with the product which are expected to become inoperative or unuseable after a reasonable period of use, including but not limited to sanding disks or pads, saw and shear blades, grinding stones, springs, chisels, nozzles, o-rings, air jets, washers and similar accessories.
- Merchandise sold by **Porter-Cable** which has been manufactured by and identified as the product of another company, such as gasoline engines. The product manufacturer's warranty, if any, will apply.
- **ANY INCIDENTAL, INDIRECT OR CONSEQUENTIAL LOSS, DAMAGE, OR EXPENSE THAT MAY RESULT FROM ANY DEFECT, FAILURE OR MALFUNCTION OF THE PRODUCT IS NOT COVERED BY THIS WARRANTY.** Some states do not allow the exclusion or limitation of incidental or consequential damages, so the above limitation or exclusion may not apply to you.
- **IMPLIED WARRANTIES, INCLUDING THOSE OF MERCHANTABILITY OR FITNESS FOR A PARTICULAR PURPOSE, ARE LIMITED TO ONE YEAR FROM THE DATE OF ORIGINAL PURCHASE.** Some states do not allow limitations on how long an implied warranty lasts, so the above limitations may not apply to you.

PORTER-CABLE

Porter-Cable Corporation
Jackson, TN USA
1-888-559-8550

Free Manuals Download Website

<http://myh66.com>

<http://usermanuals.us>

<http://www.somanuals.com>

<http://www.4manuals.cc>

<http://www.manual-lib.com>

<http://www.404manual.com>

<http://www.luxmanual.com>

<http://aubethermostatmanual.com>

Golf course search by state

<http://golfingnear.com>

Email search by domain

<http://emailbydomain.com>

Auto manuals search

<http://auto.somanuals.com>

TV manuals search

<http://tv.somanuals.com>