



PCM20A

40W MAX P.A. AMPLIFIER



www.pyleaudio.com

IMPORTANT SAFETY INSTRUCTIONS

1. **Read Instructions** — All the safety and operating instructions should be read before the appliance is operated.
2. **Retain Instructions** — The safety and operating instructions should be retained for future reference.
3. **Heed Warnings** — All warnings on the appliance and in the operating instructions should be adhered to.
4. **Follow Instructions** — All operating and use instructions should be followed.
5. **Water and Moisture** — The appliance should not be used near water -for example, near a bathtub, washbowl, kitchen sink, laundry tub, swimming pool, or a wet basement.
6. **Ventilation** — The appliance should be situated so that its location or position does not interfere with its proper ventilation. For example, the appliance should not be situated on a bed, sofa, rug, or similar surface that may block the ventilation openings; or placed in a built-in installation, such as a bookcase or cabinet that may impede the flow of air through the ventilation openings.
7. **Heat** — The appliance should be situated away from heat sources such as radiators, heat registers, stoves, or other appliances (including amplifiers) that produce heat.
8. **Power Sources** — The appliance should be connected to a power supply only of the type described in the operating instructions or as marked on the appliance.
9. **Grounding or Polarization** — Precaution should be taken to insure that the grounding or polarization means of an appliance is not defeated.
10. **Power-Cord Protection** — Power supply cords should be routed so that they are not likely to be walked on or pinched by items placed upon or against them, paying particular attention to cords at plugs, convenience receptacles, and the point at which they exit from the appliance.
11. **Cleaning** — The appliance should be cleaned only as recommended by the manufacturer.
12. **Power Lines** — An outside antenna system should not be located in the vicinity of overhead power lines or other electric light or power circuits, or where it can fall into such power lines or circuits. When installing an outside antenna system, extreme care should be taken to keep from touching such power lines or circuits as contact with them might be fatal.
13. **Nonuse Periods** — The power cord of the appliance should be unplugged from the outlet when the appliance is to be left unused for a long period of time.
14. **Object and Liquid Entry** — Care should be taken so that objects do not fall and liquids are not spilled into the enclosure through openings.
15. **Carts and Stands** — If the appliance is used with a cart or stand, the cart or stand should be a type recommended by the manufacturer.
An appliance and cart combination should be moved with care. Quick stops, excessive force, and uneven surfaces cause the appliance and cart combination to overturn.
16. **Mounting** — The appliance should be mounted only as recommended by the manufacturer.
17. **Damage Requiring Service** — The appliance should be serviced by qualified service personnel when:
 - A. The power-supply cord or plug has been damaged.
 - B. Objects have fallen into, or liquid has been spilled into the appliance enclosure.
 - C. The appliance has been exposed to rain.
 - D. The appliance has been dropped, or the enclosure damaged.
 - E. The appliance does not appear to operate normally or exhibits a marked change in performance.
18. **Servicing** — The user should not attempt to service the appliance beyond that described in the user's operating instructions. All other servicing should be referred to qualified personnel.
19. **Overloading** — Do not overload wall outlets and extension cords as this can result in a risk of fire or electric shock.
20. **Replacement Parts** — When replacement parts are required, be sure the service technician has used replacement parts specified by the manufacturer or have the same characteristics as the original part. Unauthorized substitutions may result in fire, electric shock or other hazards.
21. **Safety Check** — Upon completion of any service or repairs to this appliance, ask the service technician to perform safety checks to determine that the appliance is in proper operating condition.



<p>WARNING: To reduce the risk of fire or shock hazard, do not expose this product to rain or moisture.</p>	<p>This symbol is intended to alert you to the presence of un-insulated dangerous voltage within the product's enclosure that might be of sufficient magnitude to constitute a risk of electric shock. Do not open the product's case.</p>
<div style="display: inline-block; text-align: center; background-color: black; color: white; padding: 2px 10px; font-weight: bold; font-size: 0.8em;"> CAUTION RISK OF ELECTRIC SHOCK DO NOT OPEN </div>	
<p>CAUTION: To reduce the risk of electric shock, do not remove cover or back. No user-serviceable parts inside. Refer servicing to qualified personnel.</p>	<p>This symbol is intended to inform you that important operating and maintenance instructions are included in the literature accompanying this product.</p>

Your new **PYLE HOME PCM Amplifier**

gives you the power and versatility you need in a professional sound system. The wide frequency response of it handles easily amplification of voice and music. The talkover function on MIC 1 and one Auxiliary Input on the front panel make it perfectly in meeting halls, auditoriums, sports events in school, and paging system in offices, anywhere you need to deliver special announcement with excellent sound.

FEATURES AND CONTROLS

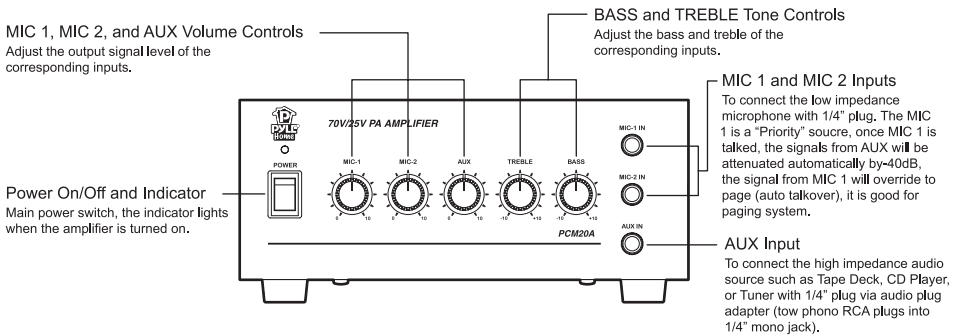

FEATURES AND CONTROLS

SPEAKER CONNECTION

One or more speakers (4, 8 or 16 Ohms) can be connected to the amplifier with or without transformers. However, before you connect any speakers to the amplifier, the total impedance must be calculated in order to avoid damage to the amplifier. A total speaker impedance greater than 8 Ohms or less than 8 Ohms can cause this damage to occur.

Voltage Switch

This PA amplifier has selectable input voltage from 110V/60Hz (the standard in USA and CANADA) to 220V/50Hz (for EUROPEAN operation). Please make sure the switch is in the proper position before operating, otherwise severe damage will be incurred and not covered by the warranty.

AC Input

Plug the included power cord into the unit first while the power is switched off, then plug the AC power cord into a proper power outlet. Please also replace the fuse only with proper rating if needed (see the fuse rating of T 1.2AL 250V for 110-120V and T 0.63AL 250V for 220-240V printed at power inlet)

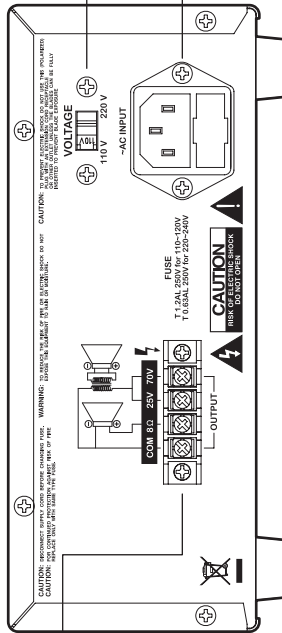

SPEAKER CONNECTION

One or more speakers (4, 8 or 16 Ohms) can be connected to the amplifier with or without transformers. However, before you connect any speakers to the amplifier, the total impedance must be calculated in order to avoid damage to the amplifier. A total speaker impedance greater than 8 Ohms or less than 8 Ohms can cause this damage to occur.

SYSTEM 1 : Single Speaker System

NOTE : Connect the speaker (+) to the amplifier's 8-Ohm terminal.

ONE SPEAKER

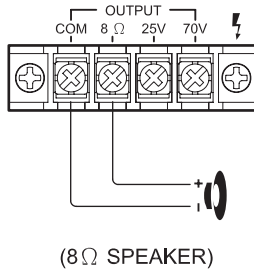

SYSTEM 2 : Two (or more) Speakers in Series

NOTE : Connect the speaker (+) to the amplifier's 8-Ohm terminal, depending on the TOTAL IMPEDANCE of the two speakers. If each speaker has an impedance of 4-Ohm, the total speaker impedance in this series configuration is 8 ohms.

TWO SPEAKERS IN SERIES

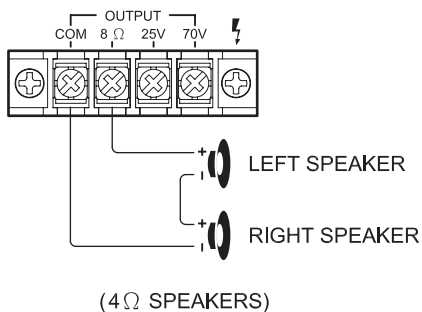

SYSTEM 3 : Two (or more) Speakers in Parallel

NOTE : Connect the speaker (+) to the amplifier's 8-Ohm terminal, depending on the TOTAL IMPEDANCE of the two speakers. If each speaker has an impedance of 16-Ohm, the total speaker impedance in this series configuration is 8 ohms.

TWO SPEAKERS IN PARALLEL

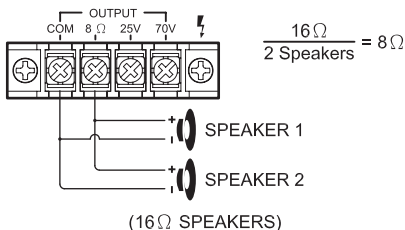

SYSTEM 4 : Four Speakers in Series and Parallel

NOTE : Although the description above is for connecting two series pairs of 8 Ohms speakers in a parallel hook up, you may also select to combine a series pair and a parallel pair in a parallel hook up, simply be sure you have calculated the total impedance, and attach the speaker (+) circuit wire to the proper amp terminal.

FOUR SPEAKERS IN SERIES / PARALLEL COMBINATION

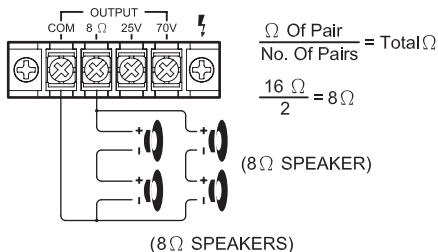

SYSTEM 5 : Connecting Speakers with Transformers

NOTE : When the 25V or 70V constant line voltages are used, a line matching transformer must be used with each speaker. All transformers must be connected in parallel, never connect line transformers in series.

SPEAKER CONNECTION

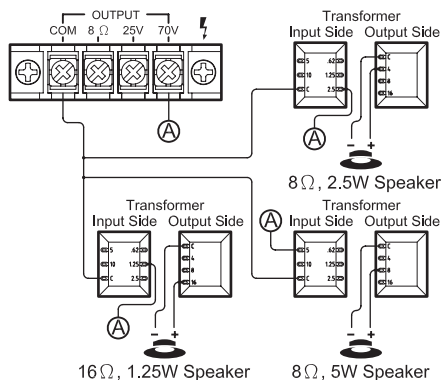

Specifications

Input Impedance

AUX.....200mV/50k-Ohm
 MIC 1/MIC 2.....1.0mV/600-Ohm

Max Output Power.....40 Watts x 1

THD at rated output power.....1% or less at 1 kHz
 Frequency Response +/- 3 dB.....50 Hz to 15 kHz
 Signal to Noise Ratio A-Weighted

MIC.....55dB
 AUX.....70dB

Speaker Outputs..... 8-Ohm, 25V, and 70V line outputs
 Attenuation Level (MIC 1).....40dB

Tone Controls

Treble.....+/- 10dB, 10 kHz
 Bass.....+/- 10dB, 100 Hz

Power Requirement.....120V AC 60Hz/230V AC 50Hz
 Power Fuse.....T 1.2AL 250V for 110-120V and
 T 0.63AL 250V for 220-240V

Dimensions, inches (mm) WxHxD.....7.87 x 3.15 x 5.90
 (200 x 80 x 150)

Weight, lbs (kg)4.5 (2.04)

Specifications are typical; individual units might vary.
 Specifications are subject to change and improvement without notice.

Limited Warranty

All PYLE HOME products are carefully constructed and tested before shipment. Units purchased in the USA are warranted to be free of defects in material and workmanship for one (1) year from the date of purchase. This warranty is limited to the original retail purchaser of the amplifier.

Should the unit fail due to factory defects in material or workmanship, your unit will be repaired or replaced at the sole discretion of PYLE.

To obtain warranty service, you must first call our Consumer Return Hotline at (718) 236-6948 to obtain a Return Authorization Number. This R.A. # must appear on the outside of your package and on all paperwork relating to your return.

When returning the unit to us for warranty service, it must be carefully packed and shipped, prepaid, to:



R.A. #: _____
 PYLE HOME Service Center
 1600 63rd Street
 Brooklyn, NY 11204

You must also include the following items with your return:

- A copy of your sales receipt or other proof of purchase
- A brief letter, indicating the problem you are experiencing with the product
- Include in your letter your return address, daytime phone number and R.A. number
- Also include a check or money order for \$15.00 for return shipping, handling and insurance, or provide your Visa/MC number with expiration date.

Our obligation under this warranty is limited to the repair or replacement of the defective unit when it is returned to us prepaid. This warranty will be considered void if the unit was tampered with, improperly serviced or subject to misuse, neglect or accidental damage.

▼ Please complete warranty card, detach and return ▼

Thank you for purchasing this PYLE product. To activate your warranty, please mail this card within 10 days.



warranty registration card

Name _____

Address _____

City, State ZIP _____

Model No. _____ Serial # (if available) _____

Date of Purchase _____

Purchased at:

- Music Products Store Sound Contractor/Installer Mail Order
 Catalog Merchandiser Other _____

www.pyleaudio.com

7 - Pyle Home PCM20A Manual

Free Manuals Download Website

<http://myh66.com>

<http://usermanuals.us>

<http://www.somanuals.com>

<http://www.4manuals.cc>

<http://www.manual-lib.com>

<http://www.404manual.com>

<http://www.luxmanual.com>

<http://aubethermostatmanual.com>

Golf course search by state

<http://golfingnear.com>

Email search by domain

<http://emailbydomain.com>

Auto manuals search

<http://auto.somanuals.com>

TV manuals search

<http://tv.somanuals.com>