



PDCDJ400

DUAL DJ CD MIXER PLAYER



INSTRUCTION MANUAL

WWW.PYLEAUDIO.COM



CAUTION:

TO REDUCE THE RISK OF ELECTRIC SHOCK DO NOT REMOVE THE COVER (OR BACK THERE ARE NO SERVICEABLE PARTS INSIDE. REFER SERVICING TO QUALIFIED SERVICE PERSONNEL.

The lightning flash with arrowhead symbol, within an equilateral triangle, is intended to alert the user to the presence of uninsulated "dangerous voltage" within the product's enclosure that may be of sufficient magnitude to constitute a risk of electric shock to persons.

The exclamation point within an equilateral triangle is intended to alert the user to the presence of important operating and maintenance (servicing) instructions in the literature accompanying the appliance.

WARNING:

1. Placing a disc with excessive downward force may damage the loader, invalidating the warranty.

2. To reduce the risk of fire or electrical shock, do not expose this appliance to rain or moisture. Electrical equipment should NEVER be kept or stored in damp environments.

DANGER:

Invisible laser radiation when open and interlock failed or defeated. Avoid direct exposure to beam.

CAUTION:





This product utilizes a laser. Use of controls or adjustments other than those specified herein may result in hazardous radiation exposure.

This unit is equipped with a user-upgradable internal firmware system via the USB Port. The firmware is responsible for the operational characteristics of the unit. Any upgrades to the firmware will be posted on our website at www.audiolinepro.com.

DISCS USABLE WITH THIS UNIT

Types of discs playable on this unit

The following marks and logos are displayed on disc labels, packaging, or jackets.

Types and Logos of playable discs			
CD	CD-TEXT ^(Note 1)	CD-R ^(Note 2)	CD-RW ^(Note 2)
			

Note 1) Regarding TEXT display:

The number of characters that can be displayed is up to 48.

When a display exceeds eight characters in length, the display will scroll. Only alpha-numeric and a limited number of symbols can be displayed.

Note 2) CD-R/CD-RW discs:

This player supports playback of CD-R/CD-RW discs recorded in audio CD format or MP3.

● For details, consult the Operating instructions for your recorder.

Notes:

- Some CD-R/CD-RW discs recorded on stand alone recorders or computer drives may not be playable back on this player, due to a variety of reasons, including disc characteristics, scratches, dirt, player lens dirt or condensation, etc.
- Some discs recorded on computer drives may not be playable on this player, depending on the recording application used, its settings, and operating environment. Be sure to use the correct formatting for the discs used. For details, consult the application author.
- This unit cannot play partially recorded CD-R or CD-R/CD-RW discs that have not been finalized.
- For data information regarding the handling of CD-R/CD-RW discs, consult the handling precautions supplied with each disc.

■ Regarding CD-R/RW discs

Due to the unique construction of CD-R/RW disc, leaving them for extended periods of time in the parse (or cue standby) mode at a single point may result in the disc becoming difficult to play at that place. The same symptom may also occur if the loop function is used to playback a single point on the disc excessively.

As a result, users are advised to construct backup archive discs when playing discs containing important data.

■ About DualDisc playback

This product is designed to conform to standards for music CDs. No warranty is made for operation or performance when used with discs not conforming to such music CD standards.

Playing MP3 files

MP3 files may be found in two formats: Constant Bit Rate (CBR) and Variable Bit Rate (VBR). This component supports play back and DJ play with both CBR and VBR type MP3 files, but in comparison with CBR files, files recorded in VBR format will experience slower search and super-fast search speeds. As a result, when operating speed is most important, the use of the CBR recording format is recommended for MP3 files.

MP3 files must follow the format requirements listed below.

MP3 format	MPEG-1	Supports Audio Layer-3 sampling frequency 32 kHz, 44.1kHz, 48 kHz, Bit Rate 32 Kbps to 320 Kbps.
	MPEG-2	Supports Audio Layer-3 sampling frequency 16 kHz, 22.05kHz, 24 kHz, Bit Rate 16 Kbps (stereo) to 160 Kbps.
	ID3 tag	Supports ID3 Vers. 1.0/1.1/2.2/2.3/2.4. Displays title, album, artist. Only alpha-numeric and a limited number of symbols can be displayed.
	File extension	.mp3, .MP3, .mP3, .Mp3

■ Playing Tracks from USB memory

- By connecting a USB memory device to the unit, MP3 files on the USB memory can be played.
- The unit may not support playback with all USB memory devices or provide sufficient electrical power.
- Reading from a USB memory device may take time if large quantities of data are involved.
- Erratic performance may result when a USB hub is used.

■ To disconnect a USB memory device

USB Memory Device Format	Folder hierarchy	Maximum eight levels (cannot play files in folders exceeding 8th hierarchy level)
	Folder Max	99
	File Max	999 (maximum 250 in single folder)
	Recording format	Devices conforming to USB mass storage class (USB MSC), including external hard discs, portable flash memory devices, and digital audio playback devices (supporting FAT 16 and FAT32 format).

■About CD-ROM playback

Disc format	File extension	.mp3、 . MP3、 . mP3、 . Mp3
	Folder layers	Maximum eight layers;files in folders exceeding eight layers cannot be played
	Maximum number of folders	99
	Maximum number of files	999
	Multi-session	Does not support multi-session When the disc used is a multi-session disc,only the first session will be played.
	CD-R recording method	Record following the ISO9660 CD-ROM file system supports only Disc At Once or Track At Once this unit does not support Packet Write recorded discs

■Precautions when using USB memory devices

- USB memory devices supported by this unit are of the class of USB mass storage devices including external hard discs,portable flash memory devices,and digital audio playback devices(supporting FAT 16 and FAT32 for mats).
- This unit may not support playback from all possible USB memory devices,or provide supply adequate power for all devices.
- Interrupted sound may be experienced during playback,depending on the type of USB memory device used,and the type of MP3 file recorded on that device.
- Additional time may be required to read in tada from large-capacity USB memory devices.
- Proper operation may not be obtained when using a USB hub.

■Features:

- Slot in type CD mechanism.
- Compatible with CD CD-R,MP3,with full DJ control.
- Supports SDHC card.
- Supports IPOD(not support IPOD touch and iphone and AAC format).
- Supports multi-partitions for external hard disks(FAT 16/32).
- Scratch、 brake and reverse DSP affect.
- CD、 USB、 SD/phono/line/mic input.
- Two universal slost and Two universal USB+SD port.
- Big VFD dot matrix display with Id3 TAG.
- Folder and Track Encoder Selector.
- Seamless loop.

PANEL:

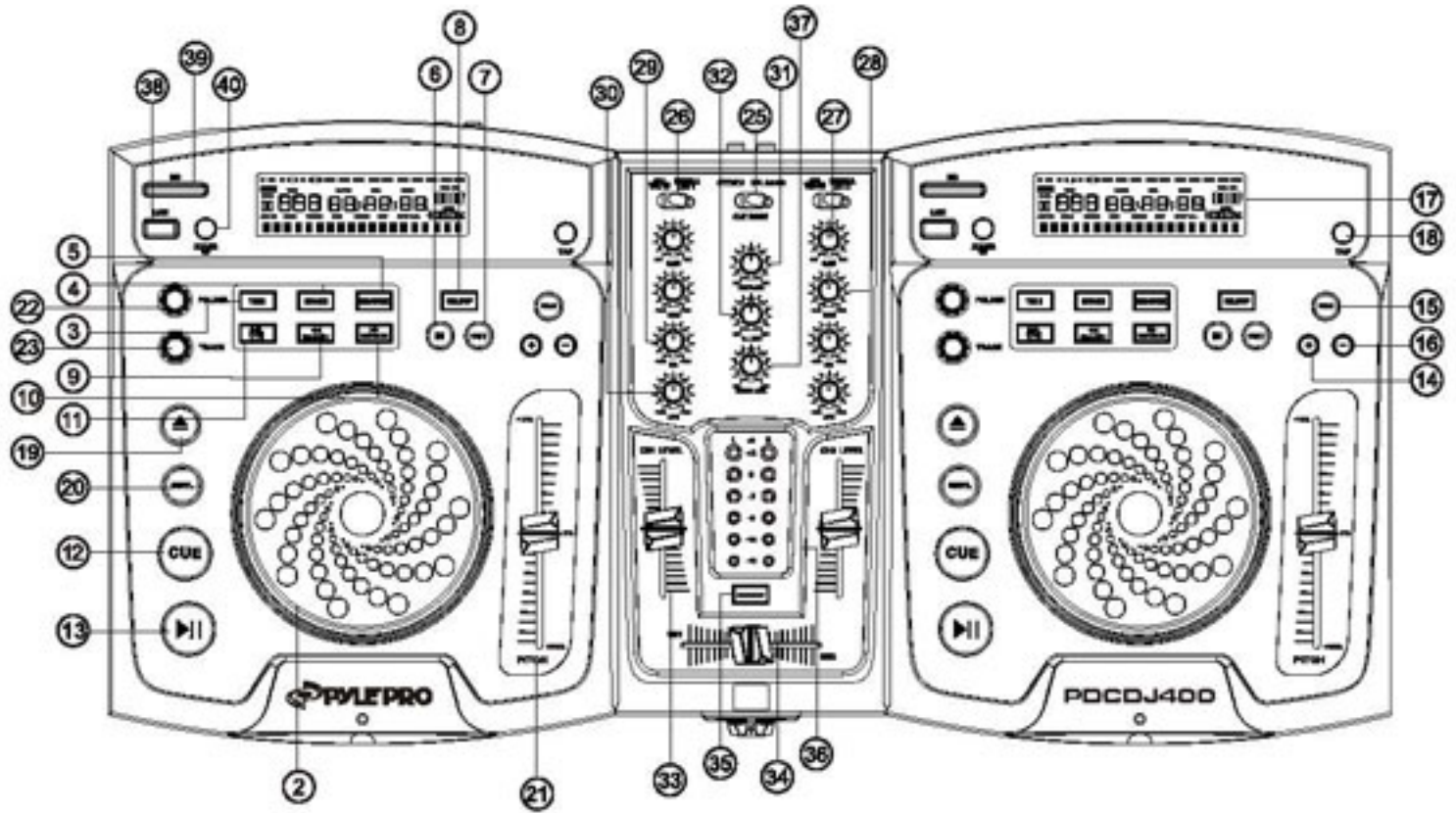

FRONT:

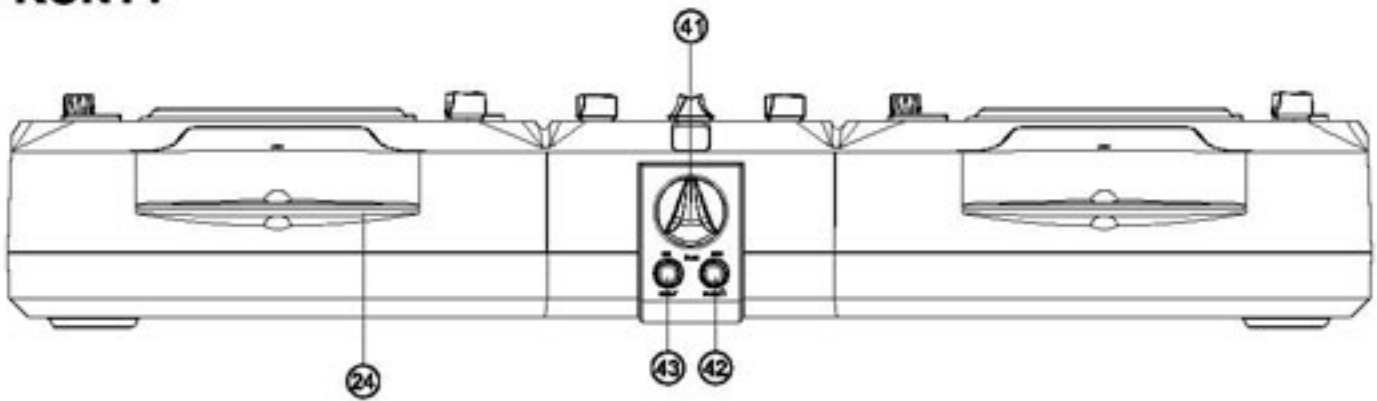

BACK:

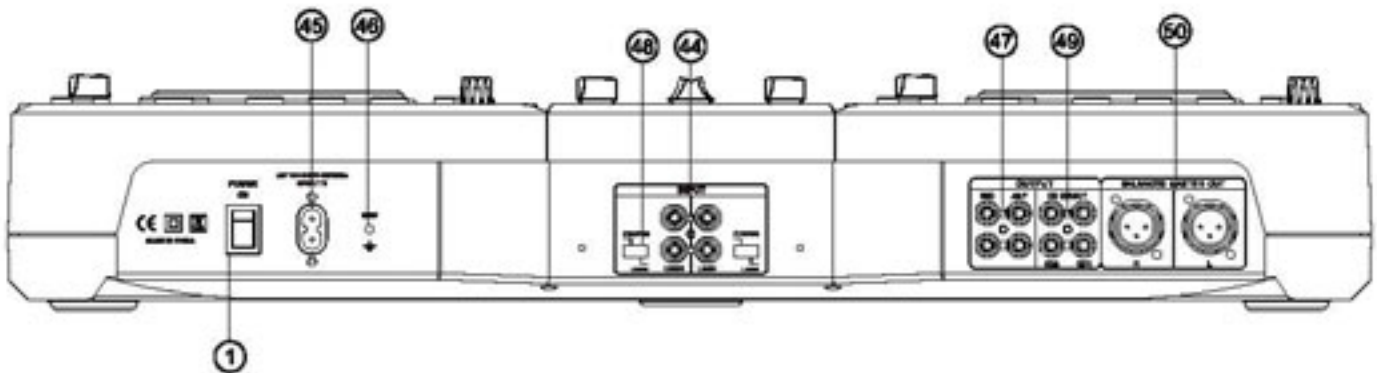

IMPORTANT

Use of controls or adjustments or performance of procedures other than those specified herein may result in hazardous radiation exposure.

FUNCTION

1.POWER BUTTON

Press the power switch to turn the unit on.To switch the POWER off press the POWER switch again.

2.JOG & SHUTTLE WHEELS

In pause mode,if you turn the jog,the point at which the sound is being produced moves by a number of frames corresponding to the number of clicks.Clockwise moves the point forward, counterclockwise moves the point backward.In play mode,the jog increases or decreases the speed of the song. (Clockwise:increase, counter-clockwise:decrease).

Meantime , dialling the jog can activate the Scratch function.

3.TIME BUTTON

Used this knob to choose the time mode:Elapsed time,remaining time or total remaining time.

4.BRAKE BUTTON

When this button is pressed,it's indicator lights for the brake dsp affect.

5.REVERSE BUTTON

When this button is pressed,it's indicator lights and the unit is set to reverse play.

6.IN BUTTON(LOOP SYSTEM)

This button sets the beginning of the loop.The Loop indicator on the display flashes.

7.OUT BUTTON(LOOP SYSTEM)

When you press this button,you set the end point of the seamless loop and you start the loop.To finish the loop,press again this button.

8.RELOOP BUTTON(LOOP SYSTEM)

This button is used to start the last saved loop,To finish the loop,press the reloop button.

9.SEARCH |◀◀ BUTTON

Constant press the search button,it will start-up double-quick backwards function.

10.SEARCH ▶▶|BUTTON

Constant press the search button,it will start-up double-quick forthcome function.

11.SINGLE/CONTINUE BUTTON

Press these to switch between the SINGLE and CONTINUOUS play mode,The selected Mode is indicated on the LCD,In SINGLE mode,after each track,the unit stop the reading, In CONTINUOU mode,the unit read all track and stops.

12.CUE BUTTON

Pressing the CUE button during play provides a return to the position at which play was started.

13.PLAY/PAUSE BUTTON

Each time you press the PLAY/PAUSE button,the operation changes from play to pause or from pause to play.

14.PITCH BEND“+”BUTTON

The pitch will automatically rise when the +button is pressed-and return to the original pitch when it is released.

15.PITCH BUTTON

If you push this button,the adjustment of the pitch potentiometer is available.

16.PITCH BEND“-”BUTTON

The pitch will drop while the - button is pressed and return to the original pitch when it is released.

17.DISPLAY

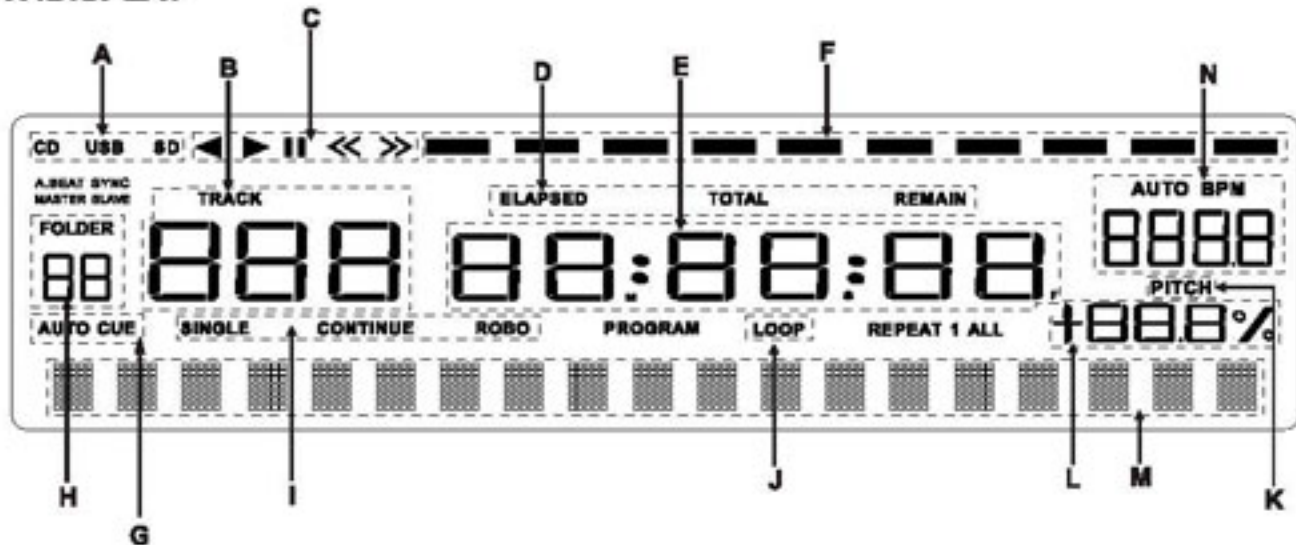

A.CD SD/USB INDICATOR

B.TRACK NUMBER

This displays the position,number of the USB or SD CARD,which is playing.

C.OPERATING MODE

▶:These indicate the operating mode of the USB or SD CARD player

⏸ :The USB or SD CARD player is playing the USB or SD CARD.

The playback is paused.

D.TIME MODE INDICATORS

ELAPSED: Played time of the selected track.

TOTAL REMAINING: Total remaining play time of the USB or SD CARD.

REMAINING: Remaining play time of the selected track.

E. MINUTE,SECOND AND FRAME DISPLAYS

These displays shows the current time,the value changes depends on the time mode selected.

F.TIME BAR INDICATOR

This is a graphical representation of the “Minute,second and frame displays”(C).

G.“CUE”INDICATOR

This indicates a new cue is set.

H.FOLDER DISPLAY

I.PLAY MODE INDICATORS

SINGLE: The USB or SD CARD player is in single mode.

CONTINUE: The USB or SD CARD player is in continue mode.

J.“LOOP”INDICATOR

This indicates the USB or SD CARD player is currently playing in a preset loop.

K.“PITCH”INDICATOR

When the "PITCH" display, the pitch slider just have function

L.PITCH DISPLAY

This indicates the playback speed(pitch), from 16% to +16%.

M.ID3 COMMUNICATION DISPLAY

N.BPM

Display the BPM of the track displayed.

18.TAP

Press the TAP button repeatedly to the beat of the music to manually determine the speed of the track. The display currently reads the value in BPM(=beats per minute).

19.OPEN/CLOSE BUTTON

Press to load or eject disk. Each press will open or close the disk tray.

NOTE: disc holder will not open unless stop or pause button has been pushed first.

20.VINYL BUTTON

When the indicator LED is light, dial the jog for VINYL function.

21.PITCH CONTROL

Use this fader to increase or decrease the speed of the track.

22.FOLDER ROTARY DIAL

Use to select folder in forward or reverse direction, The search will move one folder for each calibration unit the dial is rotated, corresponding to the direction of rotation.

23.TRACK ROTARY DIAL

Use to select tracks in forward or reverse direction(track advance), The search will move one track for each calibration unit the dial is rotated, corresponding to the direction of rotation.

24.DISC HOLDER

Place the discs in the holder, press the OPEN/CLOSE button to open and close the disc holder.

25.CUE MODE SWITCH

The switch can turn audio monitoring with headphone STEREO or SPL.MONO.

When select STEREO Headphone output stereo channel.

When select SPL MONO Headphone output SPL MONO channel, (left channel is CH1, right channel is Ch2).

26.INPUT TOGGLE SWITCH

Selects which source will be live to that channel based on what you have connected to the rear panel input section. In CD1-2 position the internal CD units are active.

27.CH1 & CH2 GAIN CONTROL

Adjust CH1 & CH2 level.

28.HIGH FADER 1-2

Adjust CH1 & CH2 equalization of high.

29.MID FADER 1-2

Adjust CH1 & CH2 equalization of mid.

30.LOW FADER 1-2

Adjust CH1 & CH2 equalization of low.

31.CUE FADER

Achieves clean seg uses between the two input channels for head phones output, Hard "left" selects channel 1, hard "right" selects channel 2.

32.DJ MIC

Adjust microphone level.

33.INPUT FADER

Controls individual source levels for CH1-2 in the mix.

34.REPLACEABLE CROSSFADER

Achieves clean segues between the two input channels. Hard left selects channel 1. "Hard right" selects channel 2. with the crossfader centered, both assigned channels are live use the crossfader for fast and seamless segues from one selected channel to the other.

35.FADER START

Activation allows you to start the CD players from you crossfader. Travel from left to right will start the right CD player and pause the left CD player.

36.LED METER

Indicates the master output level.

37.MASTER LEVEL

Adjust master level output.

38.USB PORT

Insert the sd card.

39.SD PORT

Insert the sd card.

40.CD USB/SD BUTTON

- Turn on the model default CD function.
- Press the first : control the SD card function.
- Press the second : control the USB function.
- If you take away the SD card/USB, then pressing the button, will start up the SD/USB.

41.CUE LEVEL CONTROL

42.HEADPHONE JACKS

Used to connect for audio monitoring with headphones.

43.MIC INPUT

Plug 1/4" microphone plug in here.

44.INPUT

Plug in the line level device such as tape deck or additional CD player here.

45.AC CORD

Used this cable to connect the AC mains power to the unit.

46.GND

Grounding lug for turntable connection. Always use this connection when using turntables.(Your turntable cable should have a grounding wire).

47.LINE OUT

The audio for each CD player is an output for these jacks. Connect to the line input of the mixer. the RCA output by mixer controlled.

48.LINE/PHONO INPUT SWITCH

Use this to allow either line level or phono level equipment to be plugged into your channel inputs. When phono input is selected, your signal is fed directly to the high-quality RIAA phono pre-amplifiers. Line level sources will overload the sensitive phono pre-amps and will sound very bad, so always be sure to toggle the line/phono switch over to line before connection of line sources.

49.CD DIRECTLY OUT

The audio for each CD player is an output for these jacks.
The RCA output as CD directly output, don't control by mixer.

50.BALANCED MASTER OUT

The audio for each CD player is an output for these jacks.

SPECIFICATIONS:

Anti-Shock Buffer Memory : 20 seconds

Range of adjustments : +/-16%

Power supply : 100-240V~60/50Hz

Dimensions : L595XW289XH102.7mm



Free Manuals Download Website

<http://myh66.com>

<http://usermanuals.us>

<http://www.somanuals.com>

<http://www.4manuals.cc>

<http://www.manual-lib.com>

<http://www.404manual.com>

<http://www.luxmanual.com>

<http://aubethermostatmanual.com>

Golf course search by state

<http://golfingnear.com>

Email search by domain

<http://emailbydomain.com>

Auto manuals search

<http://auto.somanuals.com>

TV manuals search

<http://tv.somanuals.com>