

PYLE[®] **PRO**



PMX1209 **CONSOLE MIXER** **INSTRUCTION MANUAL**

www.pyleaudio.com

PRECAUTIONS

PLEASE READ CAREFULLY BEFORE PROCEEDING

* Please keep this manual in a safe place for future reference.



WARNING

Always follow the basic precautions listed below to avoid the possibility of serious injury or even death from electrical shock, short-circuiting, damages, fire or other hazards. These precautions include, but are not limited to, the following:

Power supply/Power cord

- Only use the voltage specified as correct for the device. The required voltage is printed on the name plate of the device.
- Use only the specified AC power adaptor (PA-20 or an equivalent recommended by PYLE PRO).
- Do not place the power cord near heat sources such as heaters or radiators, and do not excessively bend or otherwise damage the cord, place heavy objects on it, or place it in a position where anyone could walk on, trip over, or roll anything over it.

Do not open

- Do not open the device or attempt to disassemble the internal parts or modify them in any way. The device contains no user-serviceable parts. If it should appear to be malfunctioning, discontinue use immediately and have it inspected by qualified PYLE PRO service personnel.

Water warning

- Do not expose the device to rain, use it near water or in damp or wet conditions, or place containers on it containing liquids which might spill into any openings.
- Never insert or remove an electric plug with wet hands.

If you notice any abnormality

- If the power cord or plug becomes frayed or damaged, or if there is a sudden loss of sound during use of the device, or if any unusual smells or smoke should appear to be caused by it, immediately turn off the power switch, disconnect the electric plug from the outlet, and have the device inspected by qualified PYLE PRO service personnel.
- If this device or the AC power adaptor should be dropped or damaged, immediately turn off the power switch, disconnect the electric plug from the outlet, and have the device inspected by qualified PYLE PRO service personnel.



CAUTION

Always follow the basic precautions listed below to avoid the possibility of physical injury to you or others, or damage to the device or other property. These precautions include, but are not limited to, the following:

Power supply/Power cord

- Remove the electric plug from the outlet when the device is not to be used for extended periods of time, or during electrical storms.
- When removing the electric plug from the device or an outlet, always hold the plug itself and not the cord. Pulling by the cord can damage it.
- To avoid generating unwanted noise, make sure there is 50 cm or more between the AC power adaptor and the device.
- Do not cover or wrap the AC power adaptor with a cloth or blanket.

Location

- Before moving the device, remove all connected cables.
- Avoid setting all equalizer controls and faders to their maximum. Depending on the condition of the connected devices, doing so may cause feedback and may damage the speakers.
- Do not expose the device to excessive dust or vibrations, or extreme cold or heat (such as in direct sunlight, near a heater, or in a car during the day) to prevent the possibility of panel disfiguration or damage to the internal components.
- Do not place the device in an unstable position where it might accidentally fall over.
- Do not use the device in the vicinity of a TV, radio, stereo equipment, mobile phone, or other electric devices. Otherwise, the device, TV, or radio may generate noise.

Connections

- Before connecting the device to other devices, turn off the power for all devices. Before turning the power on or off for all devices, set all volume levels to minimum.

Handling caution

- Do not insert your fingers or hand in any gaps or openings on the device.
- Avoid inserting or dropping foreign objects (paper, plastic, metal, etc.) into any gaps or openings on the device. If this happens, turn off the power immediately and unplug the power cord from the AC outlet. Then have the device inspected by qualified PYLE PRO service personnel.
- Do not use the device or headphones for a long period of time at a high or uncomfortable volume level, since this can cause permanent hearing loss. If you experience any hearing loss or ringing in the ears, consult a physician.
- Do not rest your weight on the device or place heavy objects on it, and avoid use excessive force on the buttons, switches or connectors.

XLR-type connectors are wired as follows (IEC60268 standard): pin 1: ground, pin 2: hot (+), and pin 3: cold (-).

Insert TRS phone jacks are wired as follows: sleeve: ground, tip: send, and ring: return.

PYLE PRO cannot be held responsible for damage caused by improper use or modifications to the device.

Always turn the power off when the device is not in use.

Even when the power switch is in the "STANDBY" position, electricity is still flowing to the device at the minimum level. When you are not using the device for a long time, make sure you unplug the power cord from the wall AC outlet.

The performance of components with moving contacts, such as switches, volume controls, and connectors, deteriorates over time. Consult qualified **PYLE PRO** service personnel about replacing defective components.

Copying of the commercially available music data and/or digital audio files is strictly prohibited except for your personal use.

Illustration examples shown herein are for explanatory purposes only, and may not match actual appearance during operation.

The company names and product names in this Owner's Manual are the trademarks or registered trademarks of their respective companies.

Introduction

Thank you for your purchase of the PYLE PRO PMX1209 mixing console. The PMX1209 features input channels suitable for a wide range of usage environments, and includes high-quality built-in digital effects that can provide some very serious sound. The mixer combines ease of operation with support for multiple usage environments.

Please read through this manual carefully before beginning use, so that you will be able to take full advantage of this mixer's superlative features and enjoy trouble-free operation for years to come.

Contents



Introduction	4
Contents	4
Features	4
Before Turning on the Mixer	5
Turning the Power On	5
Making the Most Of Your Mixer	6
1. A Place For Everything and Everything In Its Place.....	6
2. Where Your Signal Goes Once It's Inside the Box.....	9
3. The First Steps in Achieving Great Sound.....	10
4. External Effects, Monitor Mixes, and Groups	12
5. Making Better Mixes.....	15
Front & Rear Panels	17
Channel Control Section	17
Master Control Section	19
Rear Input/Output Section	21
Setting Up	23
Setup Procedure	23
Setup Examples	23
Rack Mounting	25
Appendix	26
Specifications	26
Dimensional Diagrams	28
Block Diagram and Level Diagram	29

Features



Input Channels.....	page 21
With up to six mic/line inputs or up to four stereo inputs, the PMX1209 can simultaneously connect to a wide range of devices: microphones, line-level devices, stereo synthesizers, and more. For example, you can connect four microphones and four stereo devices, or six microphones and two stereo devices.	
Phantom Power (+48 V).....	page 19
A single switch turns phantom power on or off for all six mic inputs. Phantom power enables easy connection to condenser microphones that require external power.	
High-quality digital effects.....	page 20
With digital effects built in, the PMX-1209 can deliver a wide range of sound variations all by itself. The unit also includes an EFFECT SEND jack that can be used to connect an external effector.	
AUX Sends and Stereo AUX Return.....	page 17, 19
You can use the AUX SEND jack to feed the post-fader signal to an external signal processor, and then return the processed stereo signal through the RETURN jack. Alternatively, you can use the PRE switch on each channel to send that channel's pre-fader signal out through the AUX SEND jack for monitoring.	
Rack Mounting.....	page 25
The mixer provides two metal rack-mount supports, and integrates easily into a wide variety of setups.	

Before Turning on the Mixer

- 1 Be sure that the mixer's power switch is in the STANDBY position.



Use only the PA-20 adaptor included with this mixer. Use of a different adaptor may result in equipment damage, overheating, or fire.

- 2 Connect the power adaptor to the AC ADAPTOR IN connector (①) on the rear of the mixer, and then turn the fastening ring clockwise (②) to secure the connection.

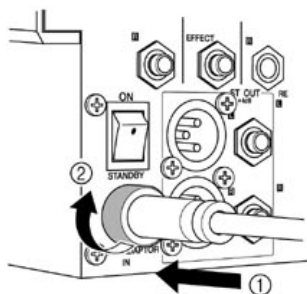

- 3 Plug the power adaptor into a standard household power outlet.



- Be sure to unplug the adaptor from the outlet when not using the mixer, or when there are lightning storms in the area.
- To avoid generating unwanted noise, make sure there is 50 cm or more between the power adaptor and the mixer.

Turning the Power On

Press the mixer's power switch to the ON position. When you are ready to turn the power off, press the power switch to the STANDBY position.



Note that trace current continues to flow while the switch is in the STANDBY position. If you do not plan to use the mixer again for a long while, please be sure to unplug the adaptor from the wall outlet.

Making the Most Of Your Mixer



■ An Introduction

You've got yourself a mixer and now you're ready to use it. Just plug everything in, twiddle the controls, and away you go ... right? Well, if you've done this before you won't have any problems, but if this is the first time you've ever used a mixer you might want to read through this little tutorial and pick up a few basics that will help you get better performance and make better mixes.

1. A Place For Everything and Everything In Its Place

1-1. A Plethora Of Connectors—What Goes Where?

Questions you're likely to encounter when setting up a system for the first time might include "Why all these different types of connectors on the back of my mixer?" and "What's the difference?".

Let's start by taking a look at the most common connector types.

■ The Venerable RCA Pin Jack

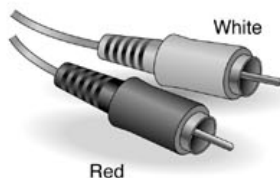

This is the "consumer connector," and the one that has been most commonly used on home audio gear for many years. Also known as "phono" jacks (short for "phonogram"), but the term isn't used much these days—besides, it's too easily confusable with "phone" jacks, below. RCA pin jacks are always unbalanced, and generally carry a line-level signal at -10 dB, nominal. You're most likely to use this type of connector when connecting a CD player or other home audio type source to your mixer, or when connecting the output of your mixer to a cassette recorder or similar gear.

■ The Versatile Phone Jack



The name "phone jack" arose simply because this configuration was first used in telephone switchboards. Phone jacks can be tricky because you can't always tell what type of signal they're designed to handle just by looking at them. It could be unbalanced mono, unbalanced stereo, balanced mono, or an insert patch point. The connector's label will usually tell you what type of signal it handles, as will the owner's manual (you *do* keep your manuals in a safe place, don't you?). A phone jack that is set up to handle balanced signals is also often referred to as a "TRS" phone jack. "TRS" stands for Tip-Ring-Sleeve, which describes the configuration of the phone plug used.

■ The Sturdy XLR



This type of connector is generally referred to as “XLR-type,” and almost always carries a balanced signal. If the corresponding circuitry is designed properly, however, XLR-type connectors will also handle unbalanced signals with no problem. Microphone cables usually have this type of connector, as do the inputs and outputs of most professional audio gear.

1-2. Balanced, Unbalanced—What’s the Difference?

In a word: “noise.” The whole point of balanced lines is noise rejection, and it’s something they’re very good at. Any length of wire will act as an antenna to pick up the random electromagnetic radiation we’re constantly surrounded by: radio and TV signals as well as spurious electromagnetic noise generated by power lines, motors, electric appliances, computer monitors, and a variety of other sources. The longer the wire, the more noise it is likely to pick up. That’s why balanced lines are the best choice for long cable runs. If your “studio” is basically confined to your desktop and all connections are no more than a meter or two in length, then unbalanced lines are fine—unless you’re surrounded by extremely high levels of electromagnetic noise. Another place balanced lines are almost always used is in microphone cables. The reason for this is that the output signal from most microphones is very small, so even a tiny amount of noise will be relatively large, and will be amplified to an alarming degree in the mixer’s high-gain head amplifier.

To summarize:

Microphones:	Use balanced lines.
Short line-level runs:	Unbalanced lines are fine if you’re in a relatively noise-free environment.
Long line-level runs:	The ambient electromagnetic noise level will be the ultimate deciding factor, but balanced is best.

■ How Do Balanced Lines Reject Noise?

*** Skip this section if technical details make you queasy. ***

Balanced lines work on the principle of “phase cancellation”: if you add two identical signals out of phase (i.e. one signal is inverted so its peaks coincide with the troughs in the other signal), the result is ... nothing. A flat line. The signals cancel each other out.

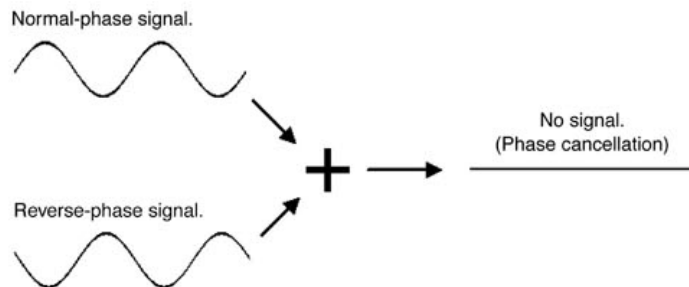

A balanced cable has three conductors:

- 1) A ground conductor which carries no signal, just the “ground” or “0” reference against which the signal in the other conductors fluctuates.
- 2) A “hot” or “+” conductor which carries the normal-phase audio signal.
- 3) A “cold” or “-” conductor which carries the reverse-phase audio signal.

While the desired audio signals in the hot and cold conductors are out of phase, any noise induced in the line will be exactly the same in both conductors, and thus in phase. The trick is that the phase of one signal is reversed at the receiving end of the line so that the desired audio signals become in-phase, and the induced noise suddenly finds itself out of phase. The out-of-phase noise signal is effectively canceled while the audio signal is left intact. Clever, eh?

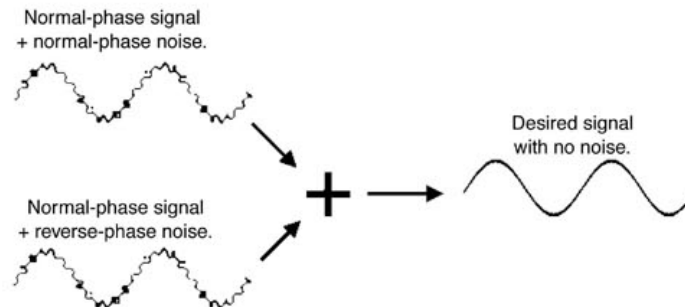

1-3. Signal Levels—Decibel Do’s and Don’ts

From the moment you start dealing with things audio, you’ll have to deal with the term “decibel” and its abbreviation, “dB”. Things can get confusing because decibels are a very versatile unit of measure used to describe acoustic sound pressure levels as well as electronic signal levels. To make matters worse there are a number of variations: dBu, dBV, dBm. Fortunately, you don’t need to be an expert to make things work. Here are a few basics you should keep in mind:

- “Consumer” gear (such as home audio equipment) usually has line inputs and outputs with a nominal (average) level of -10 dB.
- Professional audio gear usually has line inputs and outputs with a nominal level of +4 dB.
- You should always feed -10 dB inputs with a -10 dB signal. If you feed a +4 dB signal into a -10 dB input you are likely to overload the input.
- You should always feed +4 dB inputs with a +4 dB signal. A -10 dB signal is too small for a +4 dB input, and will result in less-than-optimum performance.
- Many professional and semi-professional devices have level switches on the inputs and/or outputs that let you select -10 or +4 dB. Be sure to set these switches to match the level of the connected equipment.
- Inputs that feature a “Gain” control—such as the mono-channel inputs on your PYLE PRO mixer—will accept a very wide range of input levels because the control can be used to match the input’s sensitivity to the signal. More on this later.

2. Where Your Signal Goes Once It's Inside the Box

At first glance the block diagram of even a modest mixer can look like a space-station schematic. In reality, block diagrams are a great aid in understanding how the signal flows in any mixer. Here's a greatly simplified block diagram of a generic mixer to help you become familiar with the way these things work.

2-1. Greatly Simplified Mixer Block Diagram

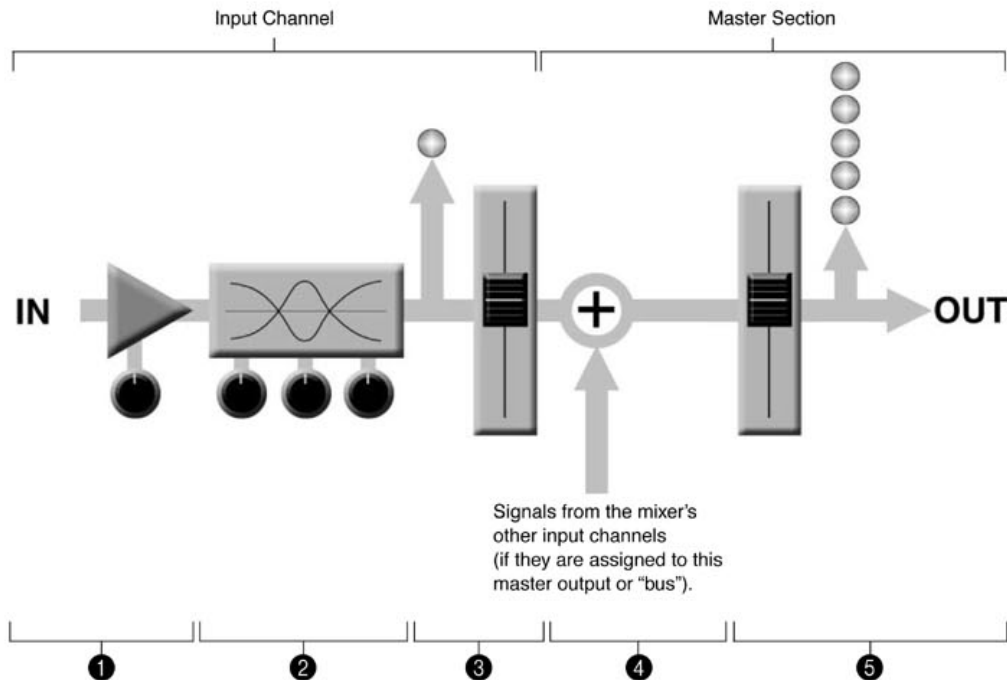

■ Input Channel

① Head Amp

The very first stage in any mixer, and usually the only stage with significant “gain” or “amplification.” The head amp has a “gain” control that adjusts the mixer’s input sensitivity to match the level of the source. Small signals (e.g. mics) are amplified, and large signals are attenuated.

② Equalizer

Could be simple bass and treble controls or a full-blown 4-band parametric EQ. When boost is applied the EQ stage also has gain. You can actually overload the input channel by applying too much EQ boost. It’s usually better to cut than boost.

③ Channel Peak LED & Fader

The channel peak LED is your most valuable tool for setting the input “gain” control for optimum performance. Note that it is located after the head amp and EQ stage.

■ Master Section

④ Summing Amplifier

This is where the actual “mixing” takes place. Signals from all of the mixer’s input channels are “summed” (mixed) together here.

⑤ Master Fader & Level Meter

A stereo, mono, or bus master fader and the mixer’s main output level meter. There could be several master faders depending on the design of the mixer—i.e. the number of buses or outputs it provides.

3. The First Steps in Achieving Great Sound

Before you even consider EQ and effects, or even the overall mix, it is important to make sure that levels are properly set for each individual source. This can't be stressed enough—initial level setup is vitally important for achieving optimum performance from your mixer! Here's why ... and how.

3-1. The Head Amplifier “Gain” Control Is the Key!

Let's review our simplified mixer block diagram:

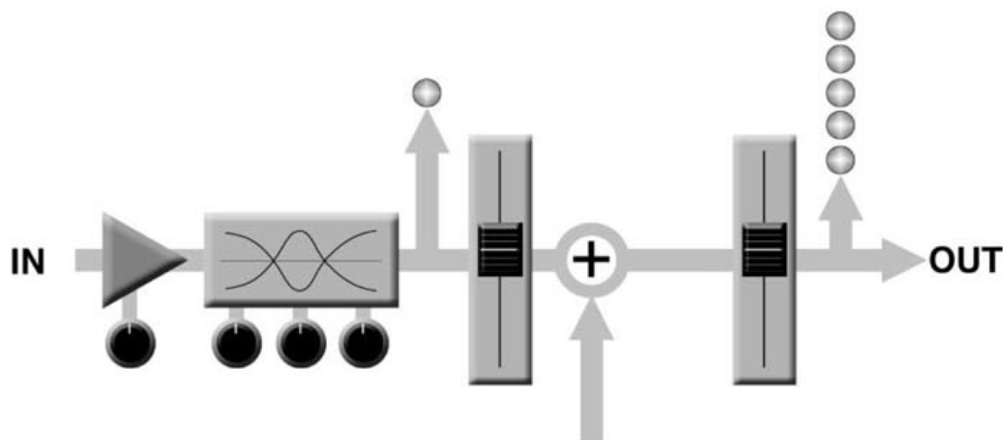

Each and every “stage” in the mixer’s signal path will add a certain amount of noise to the signal: the head amp, the EQ stage, the summing amplifier, and the other buffer and gain stages that exist in the actual mixer circuit (this applies to analog mixers in particular). The thing to keep in mind is that the amount of noise added by each stage is usually not dependent to any significant degree on the level of the audio signal passing through the circuit. This means that the bigger the desired signal, the smaller the added noise will be in relation to it. In tech-speak this gives us a better “signal-to-noise ratio”—often abbreviated as “S/N ratio.” All of this leads to the following basic rule:

To achieve the best overall system S/N ratio, amplify the input to the desired average level as early as possible in the signal path.

In our mixer, that means the head amplifier. If you don't get the signal up to the desired level at the head amplifier stage, you will need to apply more gain at later stages, which will only amplify the noise contributed by the preceding stages. Just remember that too much initial gain is bad too, because it will overload our channel circuitry and cause clipping.

3-2. Level Setup Procedure For Optimum Performance

Now that we know what we have to do, how do we do it? If you take another quick look at the mixer block diagram you'll notice that there's a peak indicator located right after the head amplifier and EQ stages, and therein lays our answer! Although the exact procedure you use will depend on the type of mixer you use and the application, as well as your personal preferences, here's a general outline:

- 1** Start by setting all level controls to their minimum: master faders, group faders (if provided), channel faders, and input gain controls. Also make sure that no EQ is applied (no boost or cut), and that all effects and dynamic processors included in the system are defeated or bypassed.
- 2** Apply the source signal to each channel one at a time: have singers sing, players play, and playback devices play back at the loudest expected level. Gradually turn up the input gain control while the signal is being applied to the corresponding channel until the peak indicator begins to flash, then back off a little so that the peak indicator flashes only occasionally. Repeat for each active channel.
- 3** Raise your master fader(s)—and group faders if available—to their nominal levels (this will be the “0” markings on the fader scale).
- 4** Now, with all sources playing, you can raise the channel faders and set up an initial rough mix.

That's basically all there is to it. But do keep your eyes on the main output level meters while setting up the mix to be sure you don't stay in the “peak zone” all the time. If the output level meters are peaking constantly you will need to lower the channel faders until the overall program falls within a good range—and this will depend on the “dynamic range” of your program material.

4. External Effects, Monitor Mixes, and Groups

4-1. AUX Buses For Monitor Sends and Overall Effects

There are a number of reasons why you might want to “tap” the signal flowing through your mixer at some point before the main outputs: the two most common being 1) to create a monitor mix that is separate from the main mix, and 2) to process the signal via an external effect unit and then bring it back into the mix. Both of these functions, and more, can be handled by the mixer’s AUX (Auxiliary) buses and level controls. If the mixer has two AUX buses, then it can handle both functions at the same time. Larger mixing consoles can have 6, 8, or even more auxiliary buses to handle a variety of monitoring and processing needs.

Using the AUX buses and level controls is pretty straightforward. The only thing you need to consider is whether you need a “pre-fader” or “post-fader” send. AUX sends often feature a switch that allows you to configure them for pre- or post-fader operation.

Pre/Post—What’s the difference?

pre	post
A “pre-fader” signal is taken from a point before the channel fader, so the send level is affected only by the AUX send level control and not by the channel fader. Pre-fader sends are most commonly used to provide monitor mixes.	A “post-fader” signal is taken from a point after the channel fader, so its level will be affected by both the AUX send level control and the channel fader. Post-fader sends are most commonly used in conjunction with the mixer’s AUX or effect returns for external effect processing.

Pre-fader send for a monitor mix. The send signal is fed to the monitor power amplifier and speaker system. The channel fader does not affect the send level so the monitor mix remains independent of the main mix. No return signal is used in this case.

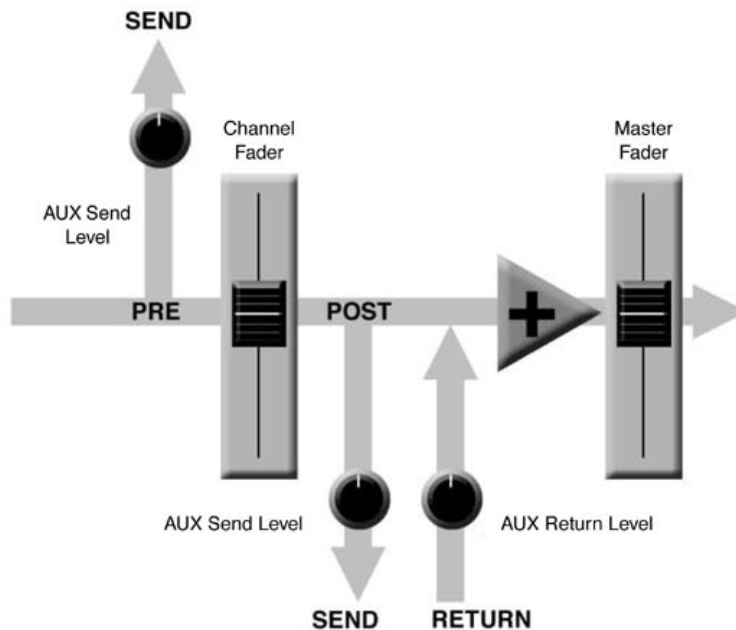

Post-fader send for external effects processing. The send signal is fed to the external effect unit—a reverb unit, for example—and the output from the effect unit is returned to the AUX Return jack and mixed back into the main program. The send level is affected by the channel fader so the effect level always remains in proportion to the channel signal.

4-2. Using Groups

Group buses and faders can greatly simplify the mixing process—particularly in live situations in which changes have to be made as quickly as possible. If you have a group of channels that need to be adjusted all together while maintaining their relative levels, grouping is the way to go. Simply assign the group to a group bus, and make sure that group is also assigned to the main program bus. Then you can adjust the overall level of the group using a single group fader, rather than having to attempt to control multiple channels faders simultaneously.

Group buses usually also have their own outputs, so you can send the group signal to a different external destination from the main mix.

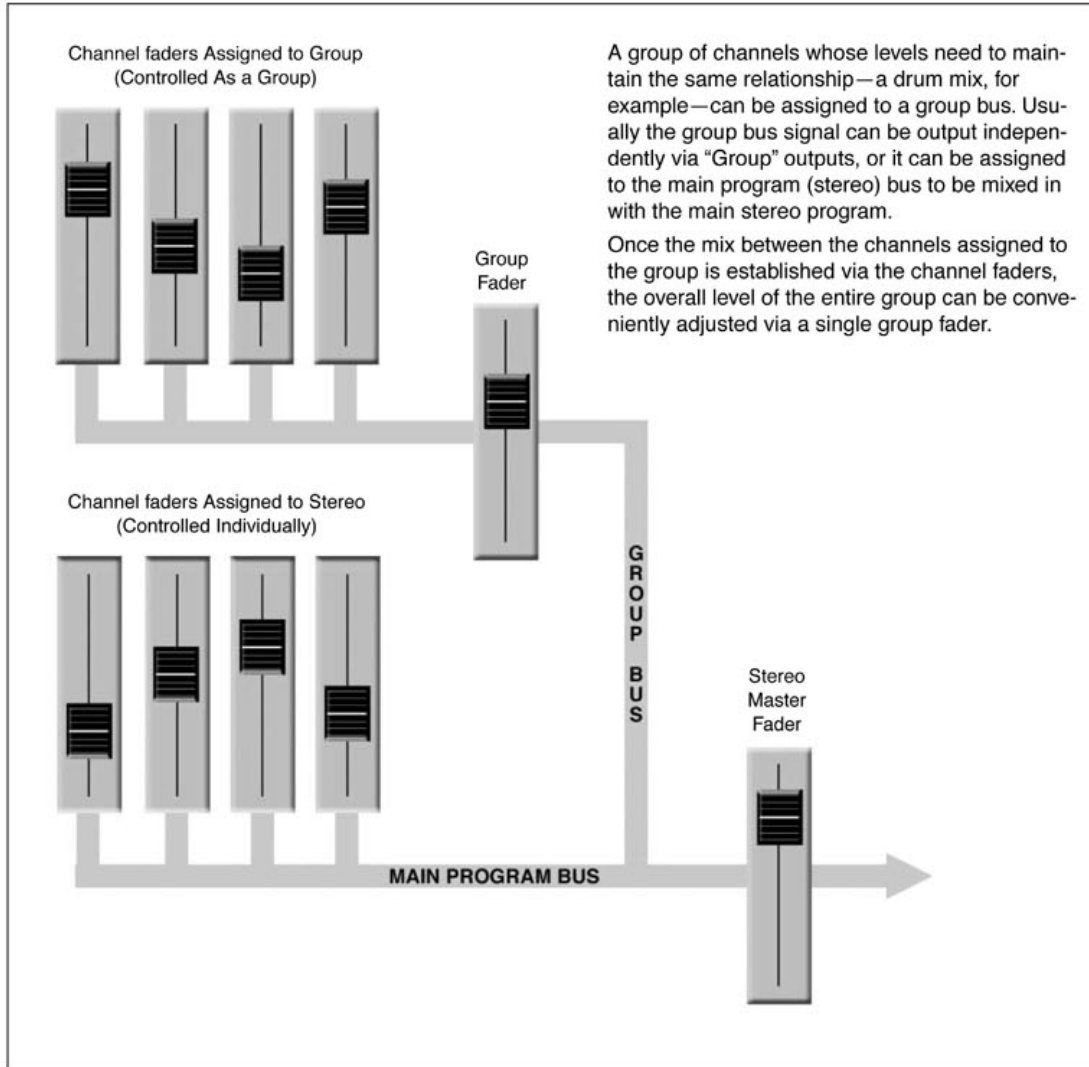

4-3. Channel Inserts for Channel-specific Processing

Another way to get the mixer’s signal outside the box is to use the channel inserts. The channel inserts are almost always located before the channel fader and, when used, actually “break” the mixer’s internal signal path. Unlike the AUX sends and returns, the channel insert only applies to the corresponding channel. Channel inserts are most commonly used for applying a dynamics processor such as a compressor or limiter to a specific channel—although they can be used with just about any type of in/out processor.

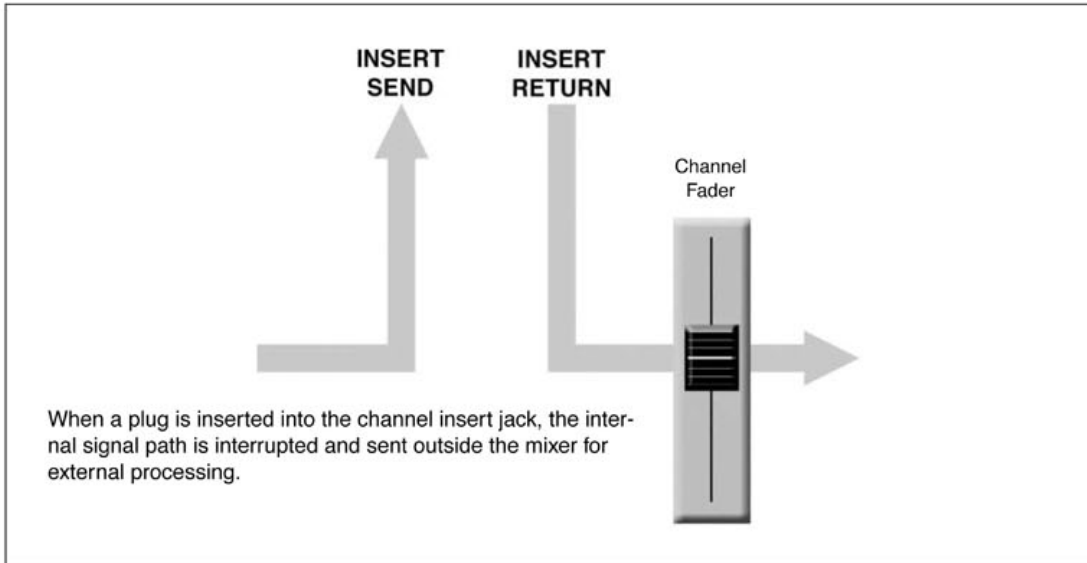

Channel insert jacks must be used with a special insert cable that has a TRS phone jack on one end and mono phone jacks on the split “Y” end. One of the mono phone jacks carries the “send” signal to be fed to the input of the external processor, and the other carries the “return” signal from the output of the processor.

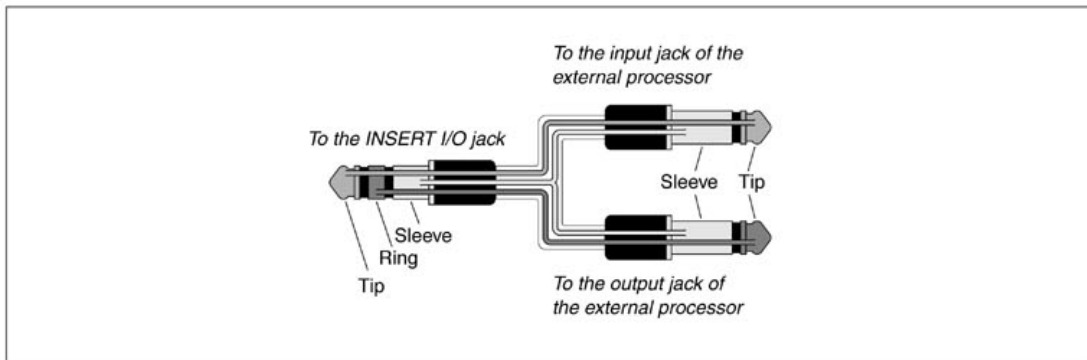

5. Making Better Mixes

5-1. Approaching the Mix—Where Do You Start?

Mixing is easy, right? Just move the faders around until it sounds right? Well, you can do it that way, but a more systematic approach that is suited to the material you're mixing will produce much better results, and faster. There are no rules, and you'll probably end up developing a system that works best for you. But the key is to *develop a system* rather than working haphazardly. Here are a few ideas to get you started:

■ Faders Down

It might sound overly simple, but it is usually a good idea to start with all channel faders off—all the way down. It's also possible to start with all faders at their nominal settings, but it's too easy to lose perspective with this approach. Start with all faders down, then bring them up one by one to fill out the mix. But which channel should you start with?

Example1:

Vocal Ballad Backed by Piano Trio

What are you mixing? Is it a song in which the vocals are the most important element? If so you might want to build the mix around the vocals. This means bringing the vocal channel up to nominal first (if your level setup procedure has been done properly this will be a good starting point), and then adding the other instruments. What you add next will depend on the type of material you are working with and your approach to it. If the vocals are backed by a piano trio and the song is a ballad, for example, you might want to bring in the piano next and get the vocal/piano relationship just right, then bring in the bass and drums to support the overall sound.

Example2:

Funky R&B Groove

The approach will be totally different if you're mixing a funky R&B number that centers on the groove. In this case most engineers will start with the drums, and then add the bass. The relationship between the drums and bass is extremely important to achieve the "drive" or groove the music rides on. Pay particular attention to how the bass works with the kick (bass drum). They should almost sound like a single instrument—with the kick supplying the punch and the bass supplying the pitch. Once again, there are no rules, but these are concepts that have been proven to work well.

■ Music First—Then Mix

In any case, the music comes first. Think about the music and let it guide the mix, rather than trying to do things the other way around. What is the music saying and what instrument or technique is being used to drive the message? That's where the focus of your mix should be. You're using a high-tech tool to do the mixing, but the mix itself is as much art as the music. Approach it that way and your mixes will become a vital part of the music.

5-2. Panning For Cleaner Mixes

Not only does the way you pan your individual channels determine where the instruments appear in the stereo sound field, but it is also vital to give each instrument its own "space" so that it doesn't conflict with other instruments. Unlike live sound in a real acoustic space, recorded stereo sound is basically 2-dimensional (although some types of surround sound are actually very 3-dimensional), and instruments positioned right on top of each other will often get in each other's way—particularly if they are in the same frequency range or have a similar sound.

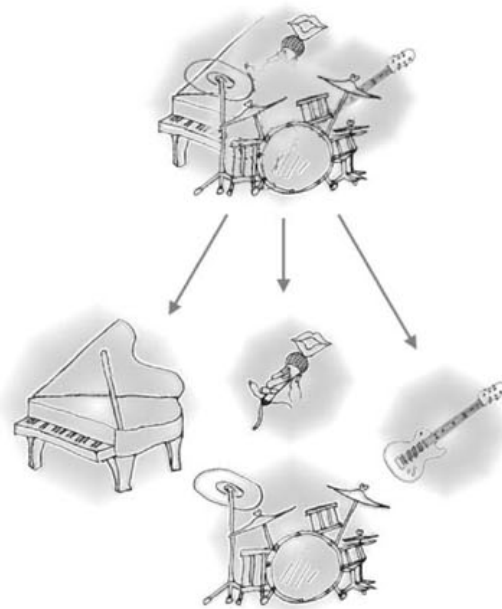

■ Spread them Out!

Position your instruments so they have room to “breathe,” and connect in the most musical way with other instruments. Sometimes, however, you’ll want to deliberately pan sounds close together, or even right on top of one another, to emphasize their relationship. There are no hard-and-fast rules. Normally (but this is not a rule), bass and lead vocals will be panned to center, as will the kick drum if the drums are in stereo.

5-3. To EQ Or Not To EQ

In general: less is better. There are many situations in which you’ll need to cut certain frequency ranges, but use boost sparingly, and with caution. Proper use of EQ can eliminate interference between instruments in a mix and give the overall sound better definition. Bad EQ—and most commonly bad boost—just sounds terrible.

■ Cut For a Cleaner Mix

For example: cymbals have a lot of energy in the mid and low frequency ranges that you don’t really perceive as musical sound, but which can interfere with the clarity of other instruments in these ranges. You can basically turn the low EQ on cymbal channels all the way down without changing the way they sound in the mix. You’ll hear the difference, however, in the way the mix sounds more “spacious,” and instruments in the lower ranges will have better definition. Surprisingly enough, piano also has an incredibly powerful low end that can benefit from a bit of low-frequency roll-off to let other instruments—notably drums and bass—do their jobs more effectively. Naturally you won’t want to do this if the piano is playing solo.

The reverse applies to kick drums and bass guitars: you can often roll off the high end to create more space in the mix without compromising the character of the instruments. You’ll have to use your ears, though, because each instrument is different and sometimes you’ll want the “snap” of a bass guitar, for example, to come through.

■ Boost With Caution

If you’re trying to create special or unusual effects, go ahead and boost away as much as you like. But if you’re just trying to achieve a good-sounding mix, boost only in very small increments. A tiny boost in the midrange can give vocals more presence, or a touch of high boost can give certain instruments more “air.” Listen, and if things don’t sound clear and clean try using cut to remove frequencies that are cluttering up the mix rather than trying to boost the mix into clarity.

One of the biggest problems with too much boost is that it adds gain to the signal, increasing noise and potentially overloading the subsequent circuitry.

5-4. Ambience

Judicious application of reverb and/or delay via the mixer’s AUX busses can really polish a mix, but too much can “wash out” the mix and reduce overall clarity. The way you set up your reverb sound can make a huge difference in the way it meshes with the mix.

■ Reverb/Delay Time

Different reverb/delay units offer different capabilities, but most offer some means of adjusting the reverb time. A little extra time spent matching the reverb time to the music being mixed can mean the difference between great and merely average sound. The reverb time you choose will depend to a great degree on the tempo and “density” of the mix at hand. Slower tempos and lower densities (i.e. sparser mixes with less sonic activity) can sound good with relatively long reverb times. But long reverb times can completely wash out a faster more active piece of music. Similar principles applies to delay.

■ Reverb Tone

How “bright” or “bassy” a reverb sound is also has a huge impact on the sound of your mix. Different reverb units offer different means of controlling this—balance between the high- and low-frequency reverb times, simple EQ, and others. A reverb that is too bright will not only sound unnatural, but it will probably get in the way of delicate highs you want to come through in your mix. If you find yourself hearing more high-end reverb than mix detail, try reducing the brightness of the reverb sound. This will allow you to get full-bodied ambience without compromising clarity.

■ Reverb Level

It’s amazing how quickly your ears can lose perspective and fool you into believing that a totally washed-out mix sounds perfectly fine. To avoid falling into this trap start with reverb level all the way down, then gradually bring the reverb into the mix until you can just hear the difference. Any more than this normally becomes a “special effect.” You don’t want reverb to dominate the mix unless you are trying to create the effect of a band in a cave—which is a perfectly legitimate creative goal if that’s the sort of thing you’re aiming for.

5-5. Built-in Effects

Your PMX mixer features a high-performance internal effect system offers extraordinary sound-processing power and versatility without the need for external equipment. The internal DSP (Digital Signal Processor) lets you individually add reverb and delay to each channel in the same way that you can with an external effect unit – but you don’t need to wire up any extra gear, and won’t suffer the signal quality loss that external connections sometimes entail. For details see page 20.

Front & Rear Panels

Channel Control Section

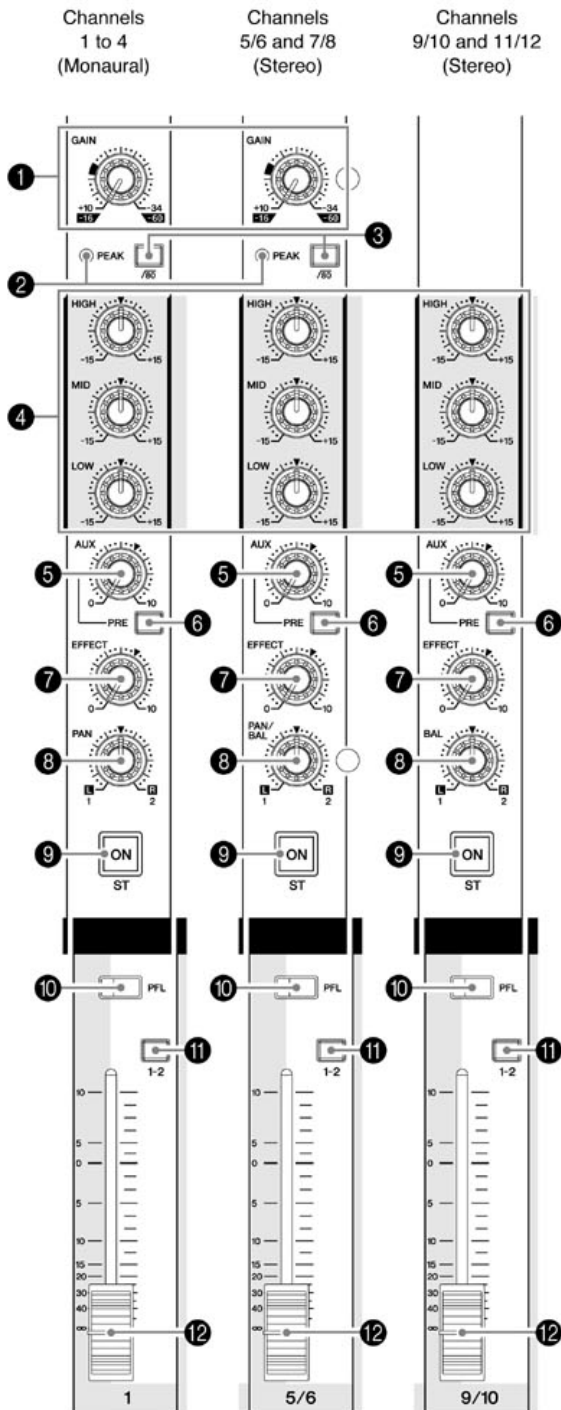

1 GAIN Control

Adjusts the input signal level. To get the best balance between the S/N ratio and the dynamic range, adjust the level so that the PEAK indicator (2) comes on only at about maximum input level. The -60 to +16 scale indicates the MIC input adjustment level. The -34 to +10 scale indicates the LINE input adjustment level.

2 PEAK Indicator

Detects the peak level of the post-EQ signal, and lights up red when the level reaches 3 dB below the clipping level. For XLR-equipped stereo input channels (5/6 and 7/8), detects both post-EQ and post-mic-amp peak levels, and lights red if either of these levels reaches 3 dB below the clipping level.

3 $\sqrt{80}$ Switch (High Pass Filter)

This switch toggles the HPF on or off. To turn the HPF on, press the switch in (▲). The HPF cuts frequencies below 80 Hz. (But note that regardless of the switch setting, the mixer does not apply this HPF to the line inputs of stereo input channels.)

4 Equalizer (HIGH, MID, and LOW)

This three-band equalizer adjusts the channel's high, mid, and low frequency bands. Setting the knob to the ▼ position produces a flat frequency response. Turning the knob to the right boosts the corresponding frequency band, while turning to the left attenuates the band. The following table shows the EQ type, base frequency, and maximum cut/boost for each of the three bands.

Band	Type	Base Frequency	Maximum Cut/Boost
HIGH	Shelving	10 kHz	±15 dB
MID	Peaking	2.5 kHz	
LOW	Shelving	100 Hz	



5 AUX Control

The AUX knob controls the signal level that the channel sends to the AUX bus. The knob should generally be set close to the ▼ position.

If you are using stereo channels, the signals from the L (odd) and R (even) channels are mixed and sent to the AUX bus.

NOTE Allows you to output the signal to the buses regardless of the setting of the ST switch (9).

6 PRE Switch

Selects whether the pre-fader or the post-fader signal is fed to the AUX bus. If you set the switch on (), the mixer sends the pre-fader signal (the signal prior to passage through channel fader 12) to the AUX bus, so that AUX output is not affected by the fader. If you set the switch off () the mixer sends the post-fader signal to the AUX bus.

7 EFFECT Controls

Adjusts the level of the signal sent from the channel to the EFFECT bus. Note that the signal level to the bus is also affected by the fader. If you are using stereo channels (CHs 5/6, 7/8, 9/10, or 11/12), the signals from the L (odd) and R (even) channels are mixed and then sent to the EFFECT bus.

8 PAN Control (1 to 4) PAN/BAL Control (5/6 and 7/8) BAL Control (9/10 and 11/12)

The PAN control determines the positioning of the channel's signal on the Group 1 and 2 buses or on the Stereo L and R buses.

The BAL control knob sets the balance between left and right channels. Signals into the L input (odd channel) feed to the Group 1 bus or to the Stereo L bus; signals into the R input (even channel) feed to the Group 2 bus or the Stereo R bus.

NOTE On channels where this knob provides both PAN and BAL controls (5/6 and 7/8), the knob operates as a PAN control if you are inputting through the MIC jack or into the L (MONO) input only, and operates as a BAL control if you are inputting into both L and R inputs.

9 ST Switch

This switch assigns the channel's signal to the Stereo L and R buses. To send the signal to the Stereo bus, set the switch on by pressing it in (). The switch lights up orange to indicate that it is on.

10 PFL (Pre-Fader Listen) Switch

This switch lets you monitor the channel's pre-fader signal. To set the switch on, press it in () so that it lights up. When the switch is on, the mixer outputs the channel's pre-fader signal to the PHONES and C-R OUT jacks, for monitoring.

11 GROUP Switch

Use this switch to assign the channel's signal to the Group output. Press the switch in () to output the signal to the Group 1 and 2 buses.

NOTE Allows you to output the signal to the buses regardless of the setting of the ST switch 9.

12 Channel Fader

Adjusts the output level of the signal being input to the channel. Use these faders to adjust the volume balance among the various channels.

NOTE To reduce noise, set the fader sliders for unused channels all the way down.

Master Control Section

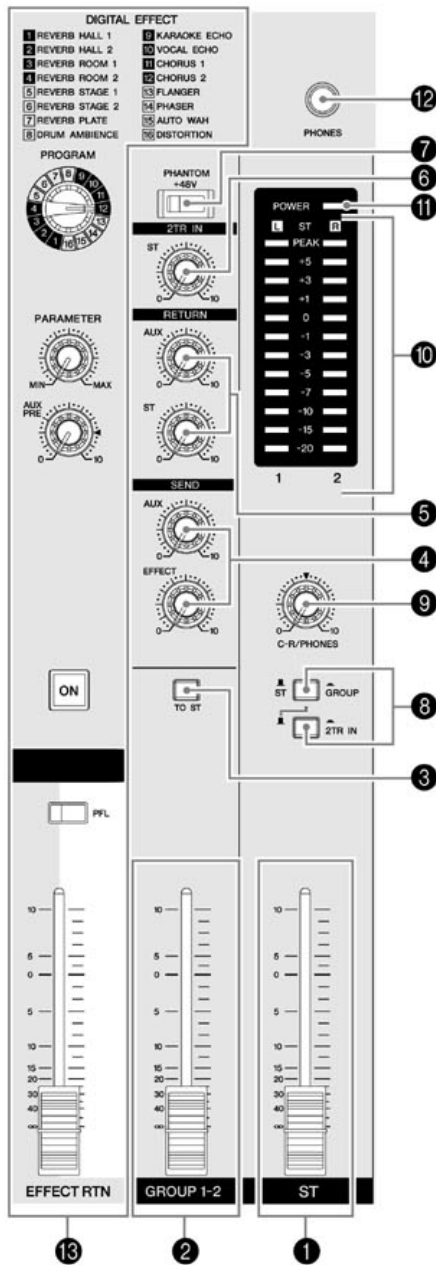

1 ST Master Fader

Adjusts the signal level to the ST OUT jacks.

2 GROUP 1-2 Fader

Adjusts the signal level to the GROUP OUT 1 and GROUP OUT 2 jacks.

3 TO ST Switch

If this switch is on (—), the mixer sends the signals processed by the GROUP 1-2 fader (2) onto the Stereo bus. The Group 1 signal goes to Stereo L and the Group 2 signal goes to Stereo R.

4 Master SEND

• Master AUX Control

Adjusts the signal level to the corresponding AUX SEND jack.

• Master EFFECT Control

Adjusts the level of the signal on the EFFECT bus. This is the signal that is output through the EFFECT jack.

NOTE These Master SEND controls do not affect the level of the signal sent from the EFFECT bus to the internal digital effector.

5 RETURN

• AUX Control

Adjust the level of the mixed L/R signal sent from the RETURN jacks (L (MONO) and R) to the AUX bus.

• ST Control

Adjust the level of the signal sent from the RETURN jacks (L (MONO) and R) to the Stereo bus.

NOTE If you supply a signal to the RETURN L (MONO) jack only, the mixer outputs the identical signal to both the L and R Stereo buses.

6 2TR IN Control

Adjusts the level of the signal sent from the 2TR IN jack to the Stereo bus.

7 PHANTOM +48 V Switch

This switch toggles phantom power on and off. If you set the switch on, the mixer supplies power to all channels that provide XLR mic input jacks (CHs 1–4, 5/6, 7/8). Set this switch on when using one or more condenser microphones.

NOTE When this switch is on, the mixer supplies DC +48 V power to pins 2 and 3 of all XLR-type MIC INPUT jacks.



• Be sure to leave this switch off (—) if you do not need phantom power.

• When tuning the switch on (—), be sure that only condenser mics are connected to the XLR input jacks (CHs: 1 to 7/8). Devices other than condenser mics may be damaged if connected to the phantom power supply. Note, however, that the switch may be left on without problem when connecting to balanced dynamic microphones.

• To avoid damage to speakers, be sure to turn off amplifiers (or powered speakers) before turning this switch on or off. We also recommend that you turn all output controls (ST master fader, GROUP 1-2 fader, etc.) to minimum settings before operating the switch, to avoid risk of loud noises that could cause hearing loss or device damage.

8 Level-Meter Signal Switches (ST-GROUP Toggle Switch and 2TR IN Switch)

These level-meter switches, together with the channel PFL switches, select the signal that is sent through the C-R/PHONES control to the C-R OUT jacks, the PHONES jack, and the level meter

The following illustration shows how the switch settings correspond to the signal selection.

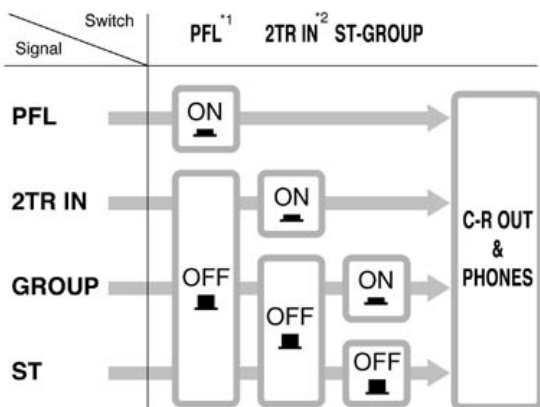

*1 If the input channel's PFL switch is on (—), then only the channel's PFL output is sent to the C-R OUT jacks, PHONES jacks, and level meter.

*2 If the 2TR IN switch is ON (—), the signal supplied to the 2TR IN jack is sent to the C-R OUT jacks, PHONE jacks, and level meter. If the 2TR IN switch is OFF, then the Group or Stereo signal is sent instead (as determined by the ST-GROUP toggle switch).

9 C-R/PHONES Control

Controls the level of the signal output to the PHONES jack and the C-R L and R jacks.

10 Level Meter

This LED display shows the level of the signal selected by the selection switches described in 8 above (the level to the C-R OUT and PHONES jacks). The "0" point corresponds to the standard output level. The indicator lights up red when the output hits the clipping level.

11 POWER Indicator

This indicator lights up when the mixer's power is ON.

12 PHONES Jack

Connector for headphones. This is a stereo phone-type output jack.

NOTE The signal monitored by these jacks is selected by the settings of the ST-GROUP toggle switch, the 2TR IN switch, and the PFL switches on the input channels.

13 DIGITAL EFFECT

• PROGRAM Dial

Selects the internal digital effect to be applied. You can select from 16 effects, as shown in the table.

No	Program	Parameter
1	REVERB HALL 1	REVERB TIME
2	REVERB HALL 2	REVERB TIME
3	REVERB ROOM 1	REVERB TIME
4	REVERB ROOM 2	REVERB TIME
5	REVERB STAGE 1	REVERB TIME
6	REVERB STAGE 2	REVERB TIME
7	REVERB PLATE	REVERB TIME
8	DRUM AMBIENCE	REVERB TIME
9	KARAOKE ECHO	DELAY TIME
10	VOCAL ECHO	DELAY TIME
11	CHORUS 1	LFO FREQ
12	CHORUS 2	LFO FREQ
13	FLANGER	LFO FREQ
14	PHASER	LFO FREQ
15	AUTO WAH	LFO FREQ
16	DISTORTION	DRIVE

• PARAMETER Control

Adjusts the parameter (depth, speed, etc.) for the selected effect.

NOTE The mixer saves the last value used with each effect type. When you change to a different effect type, the mixer automatically restores the value that was previously used with the newly selected effect (regardless of the current position of the PARAMETER Control knob). These parameter values are retained even after power-off.

• AUX PRE Control

Adjust the level of the signal sent from the internal digital effector to the AUX bus.

• ON Switch

Switches use of the internal effect on or off. The internal effect is applied only if this switch is turned on. The switch lights up orange to indicate that it is on.

With the (separately sold) PYLE PRO FC5 foot switch connected, you can use your foot to toggle the digital effects ON and OFF.

NOTE When you turn on the power, the ON switch lights up and the internal effector becomes active.

• PFL Switch

Set this switch on if you wish to output the effect signal to the PFL bus.

• EFFECT RTN Fader

Adjusts the signal level from the internal digital effector to the STEREO bus.

Rear Input/Output Section

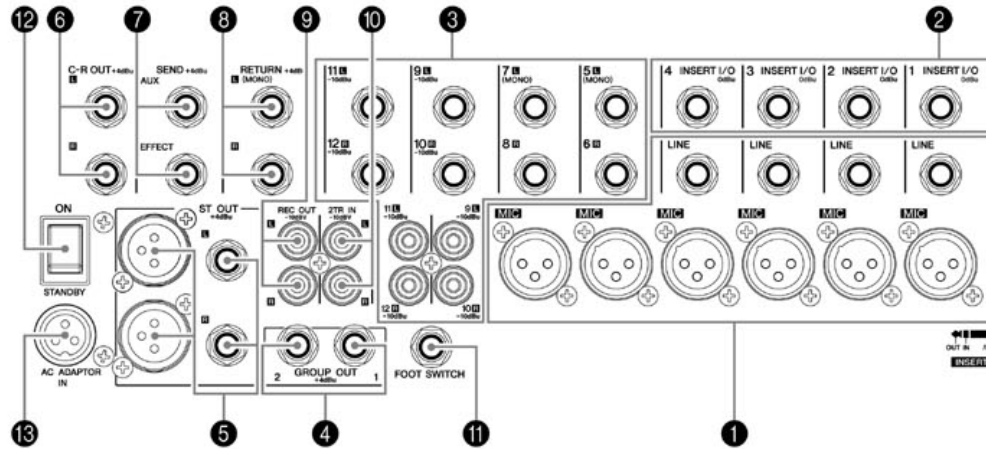

1 Channel Input Jacks

- MIC jacks (CHs 1 to 4, 5/6, 7/8)
These are balanced XLR-type microphone input jacks (1:Ground; 2:Hot; 3:Cold).
- LINE jacks (CHs 1 to 4)
These are balanced TRS phone-type line input jacks (T:Hot; R:Cold; S:Ground).
You can connect either balanced or unbalanced phone plugs to these jacks.

NOTE Where an input channel provides both a MIC INPUT jack and a LINE INPUT jack, you may use either one of these jacks but you may not use both at the same time. Please connect to only one of these jacks on each channel.

2 INSERT I/O Jacks

Each of these jacks is positioned between the equalizer and fader of the corresponding input channel (CHs 1 to 4). These jacks can be used to independently connect these channels to devices such as graphic equalizers, compressors, and noise filters. These are TRS (tip, ring, sleeve) phone jacks that support bidirectional operation.

NOTE Connection to an INSERT I/O jack requires a special separately-sold insertion cable such as illustrated below.

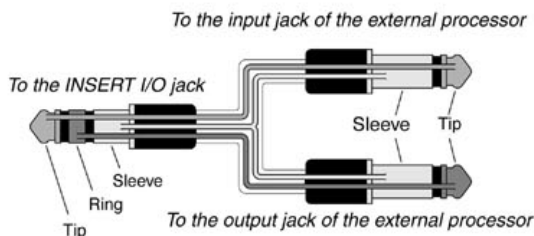

The signal output from the INSERT I/O jacks is reverse-phased. This will not be a problem if connecting the jack to an effector. If using the jack to output to an external device, however, please be aware of possible phase conflicts with other signals.

3 Channel Input Jacks

These are unbalanced stereo line input jacks. Two jack types are provided: phone type (CHs 5/6 to 11/12) and RCA pin type (CHs 9/10, 11/12).

NOTE Where a channel provides both a phone jack and an RCA pin jack, you may use either one of these jacks but you may not use both at the same time. Please connect to only of these jacks on each channel.

4 GROUP OUT (1, 2) Jacks

These are impedance-balanced phone-type output jacks that output the Group 1-2 signals. Use these jacks to connect to the input jacks of an MTR, external mixer, or other such device.

5 ST OUT (L, R) Jacks

These jacks deliver stereo output of the mixed signal. You use these jacks, for example, to connect to the power amplifier driving your main speakers. You also use these jacks when you wish to record the signal utilizing the level control applied by the ST fader in the Master Control section.

- XLR jacks
XLR-type balanced output jacks.
- LINE jacks
TRS phone-type balanced output jacks.

6 C-R OUT Jacks

Use these stereo phone-type output jacks to connect to your monitor system.

NOTE The signal monitored by these jacks is selected by the settings of the ST-GROUP toggle switch, the 2TR IN switch, and the PFL switches on the input channels.

7 SEND Jacks

• AUX

This is an impedance balanced phone-type output jack. This jack outputs the signals from AUX bus, respectively. You use this jack, for example, to connect to an effector or to a cue box or other such monitoring system.

• EFFECT

This is an impedance balanced phone-type output jack that outputs the signal from the EFFECT bus. You use this jack, for example, to connect to an external effector.

8 RETURN L (MONO), R Jacks

These are unbalanced phone-type line input jacks. The signal received by these jacks is sent to the Stereo bus and the AUX bus. These jacks are typically used to receive a return signal from an external effector (reverb, delay, etc.).

NOTE These jacks can also be used as an auxiliary stereo input. If you connect to the L (MONO) jack only, the mixer will recognize the signal as monaural and will propagate the identical signal on both L and R jacks

9 REC OUT (L, R) Jacks

By connecting these jacks to an external DAT recorder or cassette recorder, you can record the same signal that is being output from the ST OUT jacks

NOTE The mixer's ST Master Fader has no affect on the signal output from these jacks. Be sure to make appropriate level adjustments at the recording device side.

10 2TR IN Jacks

These RCA pin jacks input a stereo sound source. Use these jacks when you want to connect a CD or DAT directly to the mixer for monitoring

NOTE You can adjust the signal level using the 2TR IN control in the Master Control section.

11 FOOT SWITCH Jack

This phone input jack can connect to the (separately sold) PYLE PRO FC5 foot switch. With the foot switch connected, you can use your foot to toggle the digital effects ON and OFF.

12 POWER Switch

Use this switch to set mixer power to ON or STANDBY.



Note that trace current continues to flow while the switch is in the STANDBY position. If you do not plan to use the mixer again for a long while, be sure to unplug the adaptor from the wall outlet.

13 AC ADAPTOR IN Connector

Connects to the included PA-20 power adaptor (see page 5).



Use only the PA-20 adaptor included with this mixer. Use of a different adaptor may result in fire or electric shock.

Connector Polarities

		INPUT	OUTPUT
MIC INPUT, ST OUT	Pin 1: Ground Pin 2: Hot (+) Pin 3: Cold (-)		
LINE INPUT (monaural channels), GROUP OUT, ST OUT, C-R OUT AUX, EFFECT *	Tip: Hot (+) Ring: Cold (-) Sleeve: Ground		
INSERT I/O	Tip: Output Ring: Input Sleeve: Ground		
PHONES	Tip: L Ring: R Sleeve: Ground		
RETURN LINE INPUT (stereo channels)	Tip: Hot Sleeve: Ground		

* These jacks will also accept connection to monaural phone plugs. If you use monaural plugs, the connection will be unbalanced.

Setting Up

Setup Procedure

- 1** Before connecting to microphones and instruments, be sure that all devices are turned off. Also be sure that all of the mixer's channel faders and master control faders are set all the way down.
- 2** For each connection, connect one end of the cable to the relevant microphone or instrument and connect the other end to the appropriate input jack on the mixer.

NOTE Where an input channel provides both a MIC INPUT jack and a LINE INPUT jack, you may use either one of these jacks but you may not use both at the same time. Please connect to only one of these jacks on each channel.

- 3** To avoid causing damage to speakers, power up the devices in the following order: Peripheral devices → mixer → power amps (or powered speakers).

NOTE When shutting the system down, turn off the power in the opposite order: Power amps (powered speakers) → mixer → peripheral devices.

Setup Examples

■ Home Recording

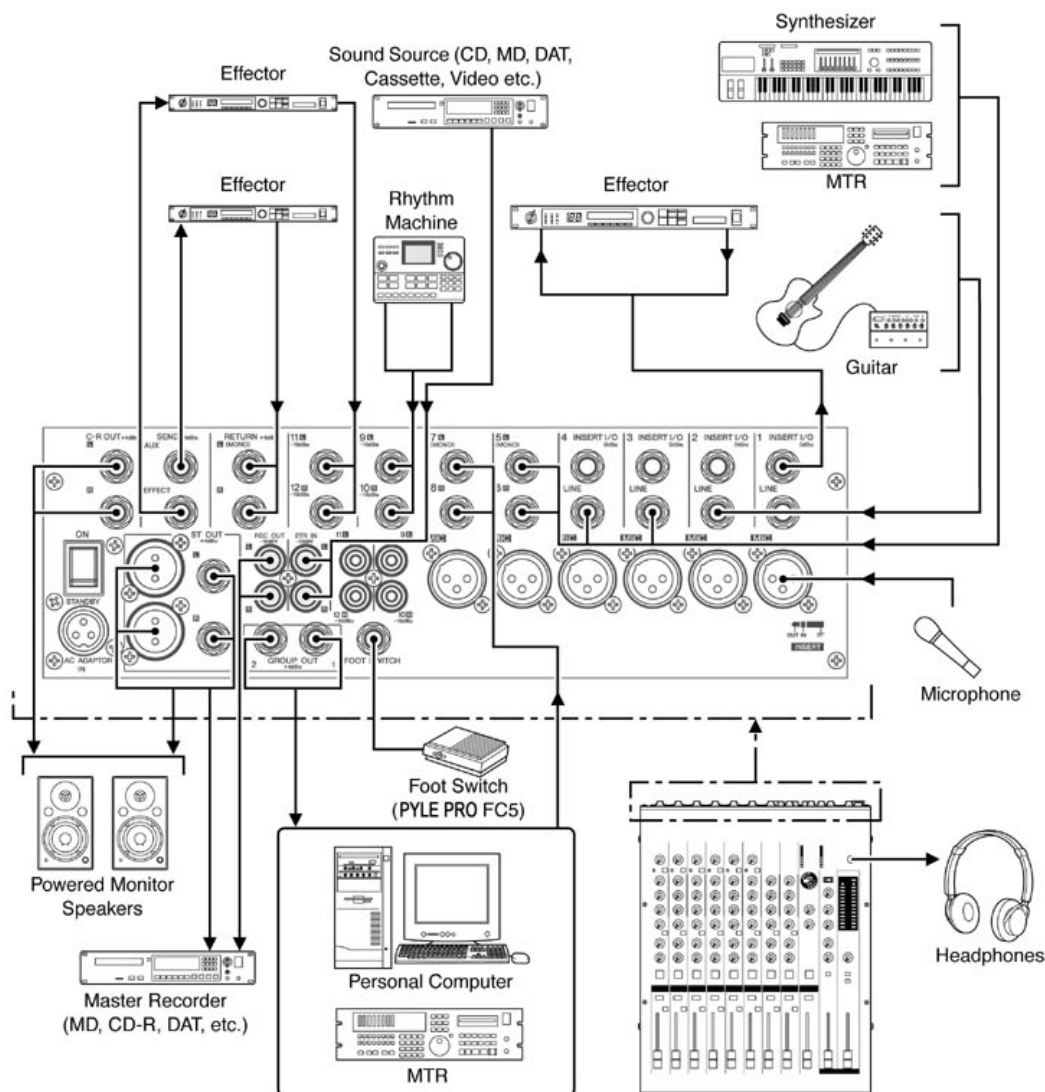

Setting Up

■ Sound Reinforcement for Live Performance

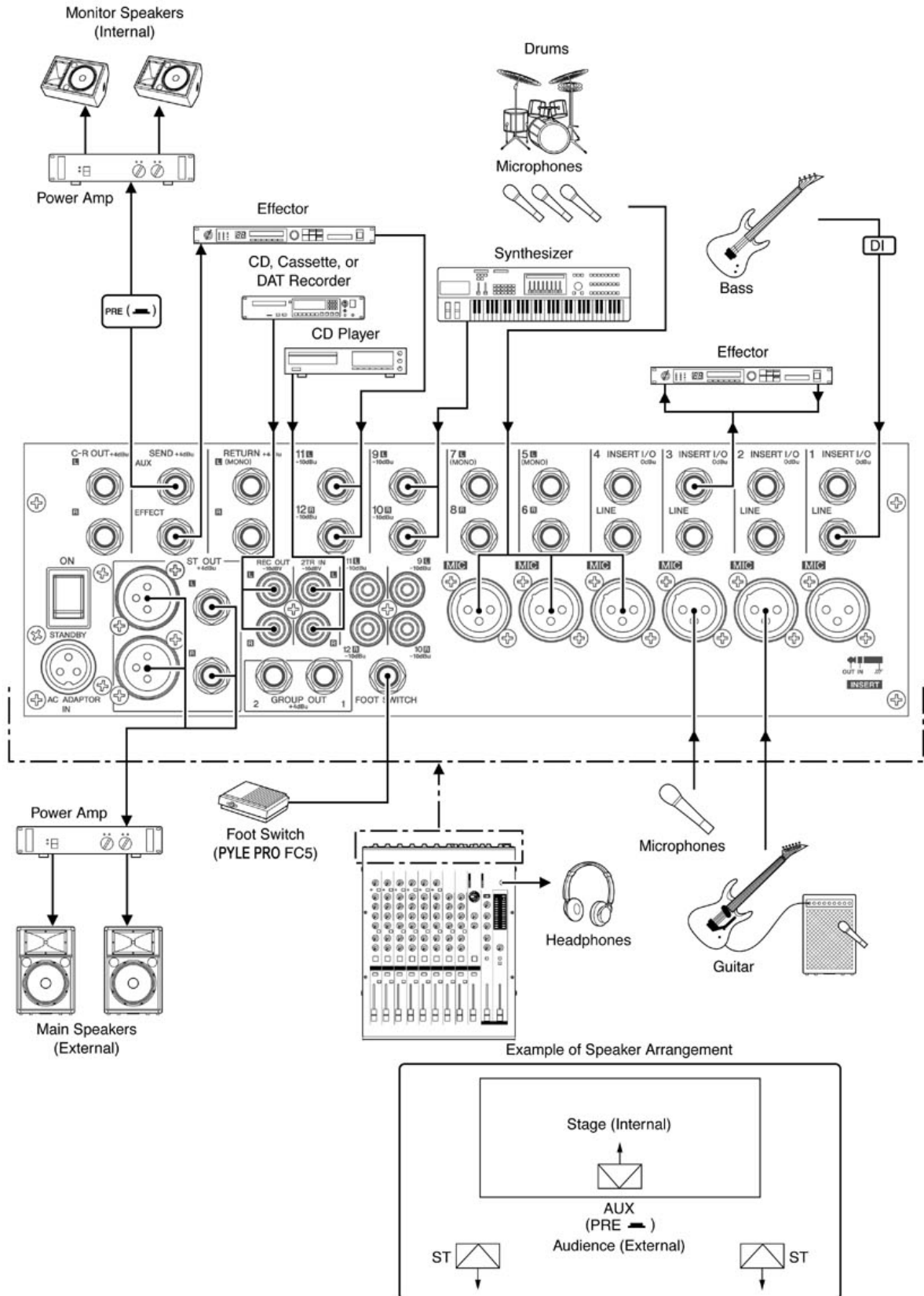

Rack Mounting

■ Mounting the PMX1209

- 1** Two metal rack-mount supports are screwed onto the unit. Use a screwdriver to remove these supports.

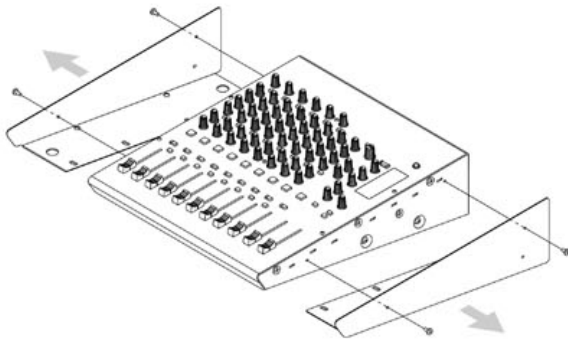

- 2** Turn the supports over, and fasten them into place again using the same screws.

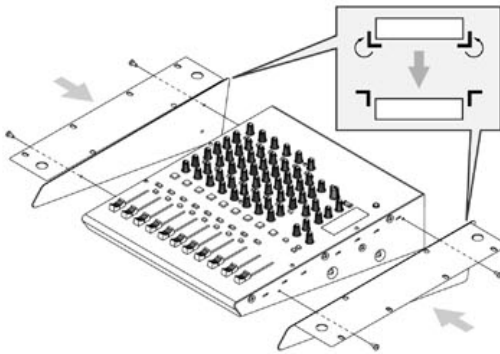

- 3** Mount the unit into the rack, and fasten it into place.



Do not install the mixer near power amps or other heat-generating devices.

Appendix

Specifications

■ Electrical Characteristics

	Conditions	MIN	TYP	MAX	UNIT
Total Harmonic Distortion (MIC to ST OUT)	(THD+N) 20 Hz-20 kHz @+14 dBu 600 ohms (CH1 to 4) with Signal input CH ST Switches are On, Signal input CH Fader, ST Master Fader at nominal level			0.1	%
Frequency Response (MIC to ST OUT)	20 Hz-20 kHz @+4 dBu 600 ohms with GAIN control at minimum level	-3	0	1	dB
Hum & Noise (20 Hz-20 kHz) Rs=150 ohms, Gain=Maximum, Sensitivity =-60 dBu, Hum & Noise are measured with a -6 dB/octave filter @12.7 kHz;equivalent to a 20 kHz filter with infinite dB/octave attenuation.	Equivalent Input Noise (CH1 to 4)			-128	dBu
	Residual Output Noise (ST OUT)			-100	dBu
	ST, GROUP Master Fader at nominal level and all CH Group Switches and ST Switches are off. (ST, GROUP OUT)			-88 (92 dB S/N)	dBu
	AUX Master Control at nominal level and all CH mix controls at minimum level. (AUX SEND)			-81 (85 dB S/N)	dBu
Maximum Voltage Gain PAN/BAL : panned hard left or hard right.	CH MIC INPUT to CH INSERT OUT		60		dB
	CH MIC INPUT to GROUP OUT, ST OUT (CH to ST)		84		dB
	CH MIC INPUT to ST OUT (GROUP to ST)		94		dB
	CH MIC INPUT to REC OUT (CH to ST)		62.2		dB
	CH MIC INPUT to AUX SEND (PRE)		76		dB
	CH MIC INPUT to AUX SEND (POST), EFFECT SEND		86		dB
	CH LINE INPUT to GROUP OUT, ST OUT (CH to ST)		58		dB
	ST CH MIC INPUT to GROUP OUT, ST OUT (CH to ST)		84		dB
	ST CH LINE INPUT to GROUP OUT, ST OUT (ST CH to ST)		58		dB
	ST CH LINE INPUT to AUX SEND (PRE)		47		dB
	ST CH LINE INPUT to AUX SEND (POST), EFFECT SEND		57		dB
	ST CH INPUT to GROUP OUT, ST OUT (ST CH to ST)		34		dB
	RETURN to ST OUT		16		dB
	RETURN to AUX SEND		9		dB
2TR INPUT to ST OUT		27.8		dB	
Crosstalk (1 kHz)	Adjacent inputs			-70	dB
	input to output			-70	dB
Monaural/Stereo Input GAIN Control	variable range		44		dB

Where 0 dBu = 0.775 V

■ General Specifications

Monaural/Stereo CH High Pass Filter	80 Hz 12 dB/octave
Monaural/Stereo CH Equalization Turn over /roll-off frequency of shelving, 3 dB below maximum variable level	±15 dB (Max. Variation) HIGH: 10 kHz (shelving) MID: 2.5 kHz (peaking) LOW: 100 Hz (shelving)
Internal Digital Effect	16 programs, Parameter control FOOT switch (ON/OFF)
Phantom Power	Supplied when Phantom +48 V switch is ON. (XLR-type input jacks)
Monaural/Stereo Input PEAK Indicator	On each channel: red indicator lights if post-EQ signal (on ST channels, if either post-EQ signal or post-mic-amp signal) comes within 3 dB of the clipping level.
Level Meters	Two 12-points LED level meters [ST (L, R)] Peak point: red indicator +5, +3, +1, 0: yellow indicators -1, -3, -5, -7, -10, -15, -20: green indicators
Included Accessories	Power adaptor (PA-20)
Options	Footswitch (FC5)
Power Consumption	36 W
Dimensions (W × H × D)	322 mm × 108 mm × 416.6 mm
Weight	5 kg

Where 0 dBu = 0.775 V

■ Input Specifications

Input Connector	Gain	Input Impedance	Appropriate Impedance	Sensitivity*	Nominal Level	Max. Before Clipping	Connector Specifications
MIC INPUT (CHs 1 to 4)	-60	3 k Ω	50–600 Ω mic	-80 dBu (0.078 mV)	-60 dBu (0.775 mV)	-40 dBu (7.75 mV)	XLR-3-31 type (balanced)
	-16			-36 dBu (12.3 mV)	-16 dBu (123 mV)	+4 dBu (1.23 V)	
LINE INPUT (CHs 1 to 4)	-34	10 k Ω	600 Ω line	-54 dBu (1.55 mV)	-34 dBu (15.5 mV)	-14 dBu (155 mV)	Phone jack (TRS) (balanced [T: hot; R: cold; S: ground])
	+10			-10 dBu (245 mV)	+10 dBu (2.45 V)	+30 dBu (24.5 V)	
ST CH MIC INPUT (CH5(L)/CH6(R), CH7(L)/CH8(R))	-60	3 k Ω	50–600 Ω mic	-80 dBu (0.078 mV)	-60 dBu (0.775 mV)	-40 dBu (7.75 mV)	XLR-3-31 type (balanced)
	-16			-36 dBu (12.3 mV)	-16 dBu (123 mV)	-10 dBu (245 mV)	
ST CH LINE INPUT (CH5(L)/CH6(R), CH7(L)/CH8(R))	-34	10 k Ω	600 Ω line	-54 dBu (1.55 mV)	-34 dBu (15.5 mV)	-14 dBu (155 mV)	Phone jack (unbalanced)
	+10			-10 dBu (245 mV)	+10 dBu (2.45 V)	+30 dBu (24.5 V)	
ST CH INPUT (CH9(L)/CH10(R), CH11(L)/CH12(R))		10 k Ω	600 Ω line	-30 dBu (24.5 mV)	-10 dBu (245 mV)	+10 dBu (2.45 V)	Phone jack (unbalanced); RCA pin jack
CH INSERT IN (CHs 1 to 4)		10 k Ω	600 Ω line	-20 dBu (77.5 mV)	0 dBu (0.775 V)	+20 dBu (7.75 V)	Phone jack (TRS) (unbalanced [T: out; R: in; S: ground])
RETURN (L, R)		10 k Ω	600 Ω line	-12 dBu (195 mV)	+4 dBu (1.23 V)	+24 dBu (12.3 V)	Phone jack (unbalanced)
2TR IN (L, R)		10 k Ω	600 Ω line	-26 dBV (50.1 mV)	-10 dBV (316 mV)	+10 dBV (3.16 V)	RCA pin jack

Where 0 dBu = 0.775 V and 0 dBV = 1 V

* Input sensitivity: the lowest level that will produce the nominal output level when the unit is set to maximum gain.

■ Output Specifications

Output Connectors	Output Impedance	Appropriate Impedance	Nominal Level	Max. Before Clipping	Connector Specifications
ST OUT (L, R)	150 Ω	600 Ω line	+4 dBu (1.23 V)	+24 dBu (12.3 V)	XLR-3-32 type (balanced) Phone jack (TRS) (balanced [T: hot; R: cold; S: ground])
GROUP OUT (1-2) AUX SEND EFFECT SEND	150 Ω	10 k Ω line	+4 dBu (1.23 V)	+20 dBu (7.75 V)	Phone jack (TRS) (impedance balanced [T: hot; R: cold; S: ground])
CH INSERT OUT (CHs 1 to 4)	150 Ω	10 k Ω line	0 dBu (0.775 V)	+20 dBu (7.75 V)	Phone jack (TRS) (unbalanced [T: out; R: in; S: ground])
REC OUT (L, R)	600 Ω	10 k Ω line	-10 dBV (316 mV)	+10 dBV (3.16 V)	RCA pin jack
C-R OUT (L, R)	150 Ω	10 k Ω line	+4 dBu (1.23 V)	+20 dBu (7.75 V)	Phone jack (TRS) (impedance balanced [T: hot; R: cold; S: ground])
PHONES	100 Ω	40 Ω phone	3 mW	75 mW	Stereo phone jack

Where 0 dBu = 0.775 V and 0 dBV = 1 V

Specifications and descriptions in this owner's manual are for information purposes only. PYLE PRO. reserves the right to change or modify products or specifications at any time without prior notice. Since specifications, equipment or options may not be the same in every locale, please check with your PYLE PRO dealer.

Dimensional Diagrams

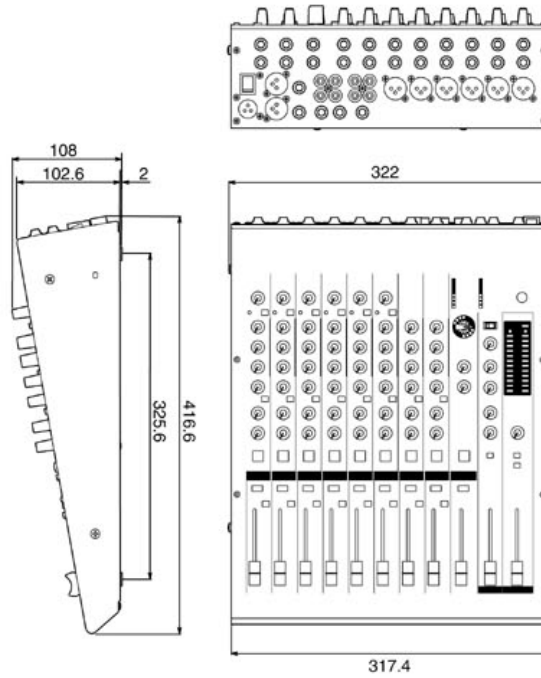

When mounted on rack

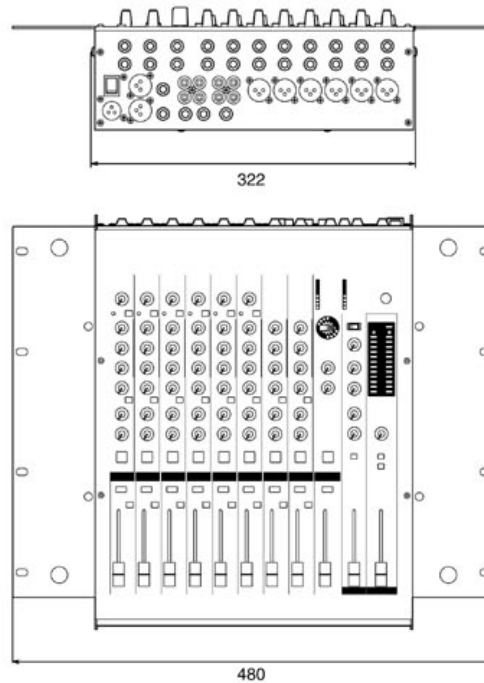

Block Diagram and Level Diagram

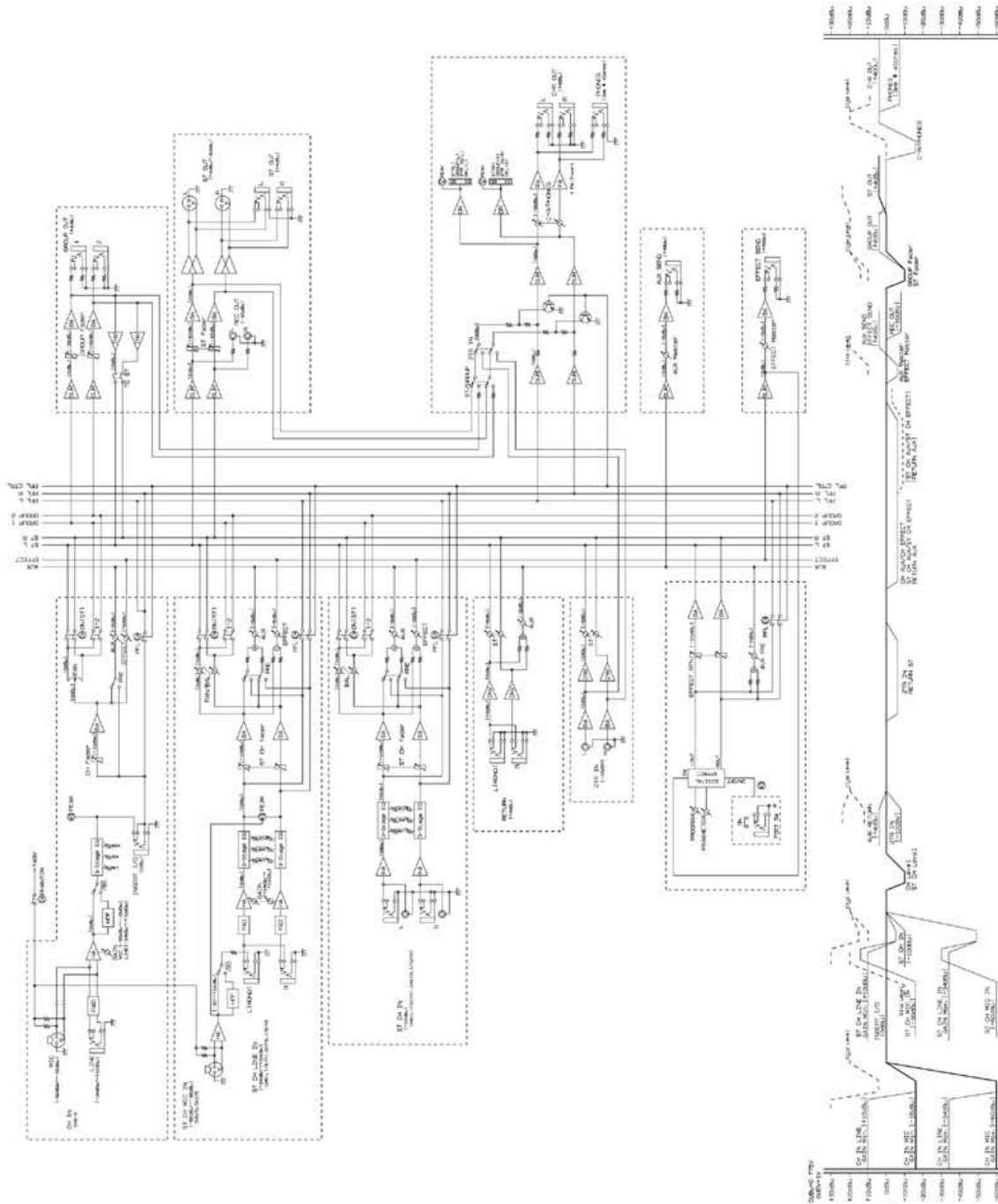



Pyle pro, Inc.

1600 63rd Street

Brooklyn, NY 11204

www.pyleaudio.com

Download from Www.Somanuals.com. All Manuals Search And Download.

Free Manuals Download Website

<http://myh66.com>

<http://usermanuals.us>

<http://www.somanuals.com>

<http://www.4manuals.cc>

<http://www.manual-lib.com>

<http://www.404manual.com>

<http://www.luxmanual.com>

<http://aubethermostatmanual.com>

Golf course search by state

<http://golfingnear.com>

Email search by domain

<http://emailbydomain.com>

Auto manuals search

<http://auto.somanuals.com>

TV manuals search

<http://tv.somanuals.com>