

PYLE[®] PRO

PYD-1918/PYD1928
PYD-1938/PYD-1948
PYD-1958

4 channel professional mixer

pro series



Your PYLE PRO Series Performance Mixer

is a sophisticated control center, perfect for mixing sound from multiple playback sources such as microphones, tuners, CD players, turntables or the audio outputs from a VCR. This mixer is ruggedly constructed for home or professional use. Wide range volume controls permit you to adjust sound levels accurately to achieve just the right mix for playing through your speaker system or for recording.

Please read this manual thoroughly before you attempt to set up and use the mixer. It contains a range of suggestions and instructions to insure safe usage. Set up and used properly, you can expect years of trouble-free service from this product.

Owner's Manual Table of Contents

- | | |
|---|--|
| <ul style="list-style-type: none"> <i>i</i> Input/Output Features 1 Features and Controls: PYD-1918 2 Features and Controls: PYD-1928 3 Features and Controls: PYD-1938 4 Features and Controls: PYD-1948 5 Features and Controls: PYD-1958 6 Presetting Controls Before Use 8 Using the Mixer Inputs 8 Using the Gain Controls Connecting the Mixer's Outputs to Amplifiers to Recorders to Zone Speakers 9 Using Headphones Connecting the Lamp 10 Using the Mixer Controls Turning On the Mixer | <ul style="list-style-type: none"> 10 Monitoring ("Cueing") Inputs Mixing Inputs Adding Equalization to the Mix 11 Adding External Effects to the Mix Using the Microphone Talkover Mode Microphone Tone and Level Controls Using the MIC Kill Frequency Switches 12 Using the Mono/Stereo Switch Using the Crossfader w/Assign Switches Using the Echo Controls (PYD-1928 and PYD-1948) Using the Sound Effects (PYD-1938 and PYD-1948) Using the Digital Sampler (PYD-1958) 13 Troubleshooting Care and Maintenance 14 Specifications Warranty |
|---|--|

Input/Output Features: all models

Effects Send/Receive jacks permits you to either include externally generated effects (such as a digital sampler or synth) IN the mix, or to process the mixed sound (echo reverb, etc.).

Stereo Line Inputs let you connect most high-level audio sources, such as CD players, tape deck, tuner or VCR.

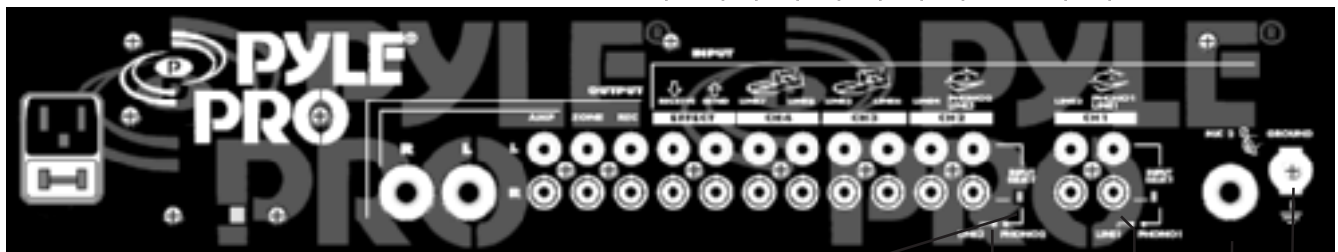

Output Jacks to connect the mixer to a receiver or amplifier – choose to use cables with either 1/4" plugs or RCA plugs.

Zone Output Jacks to connect the mixer to a second receiver or amplifier powering speakers in the DJ booth or in a remote location

Record Output Jacks to connect the mixer to a tape deck for recording the mixed program

Dual Purpose Stereo Inputs for using a turntable with a magnetic cartridge OR a high level input source

Input Select Switches – set these switches based on what is plugged into Phono1/Line1 and Phono2/Line3 input jacks

Ground Screw for turntables

MIC2 Microphone connector permits you to connect a balanced or unbalanced low impedance microphone with 1/4" plug.

Features and Controls: PYD1918 Mixer

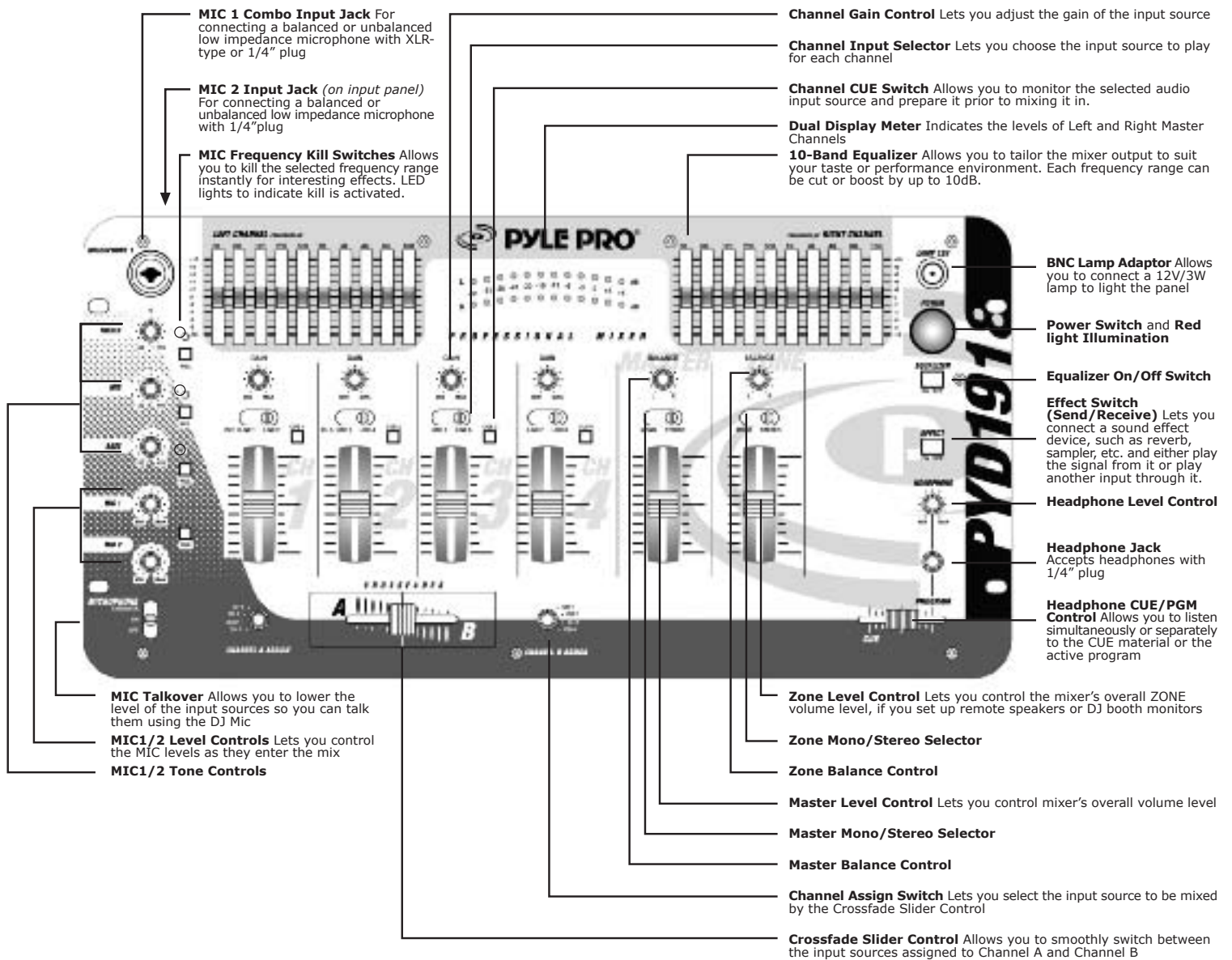

Features and Controls: PYD1928 Mixer

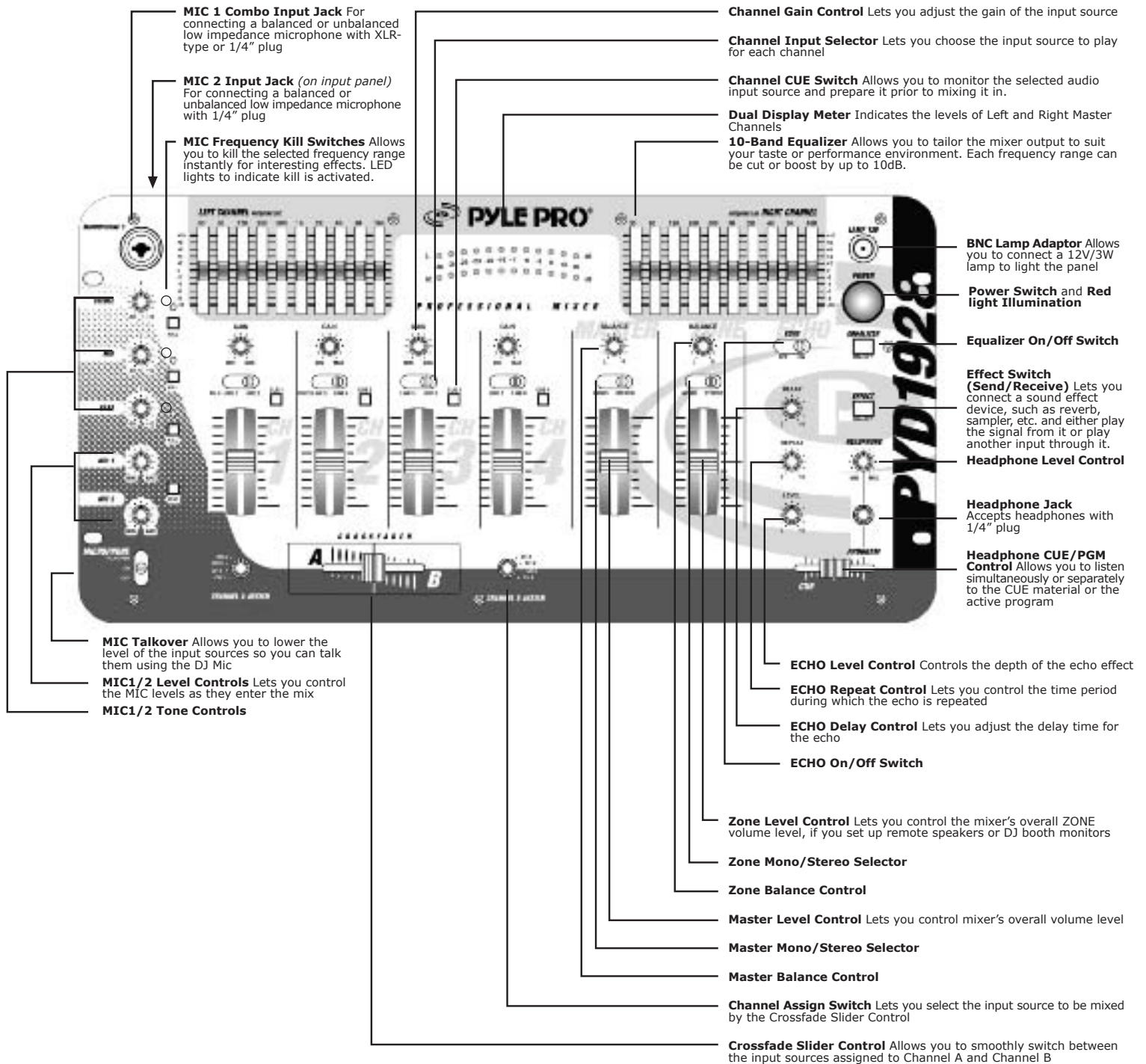

Features and Controls: PYD1938 Mixer

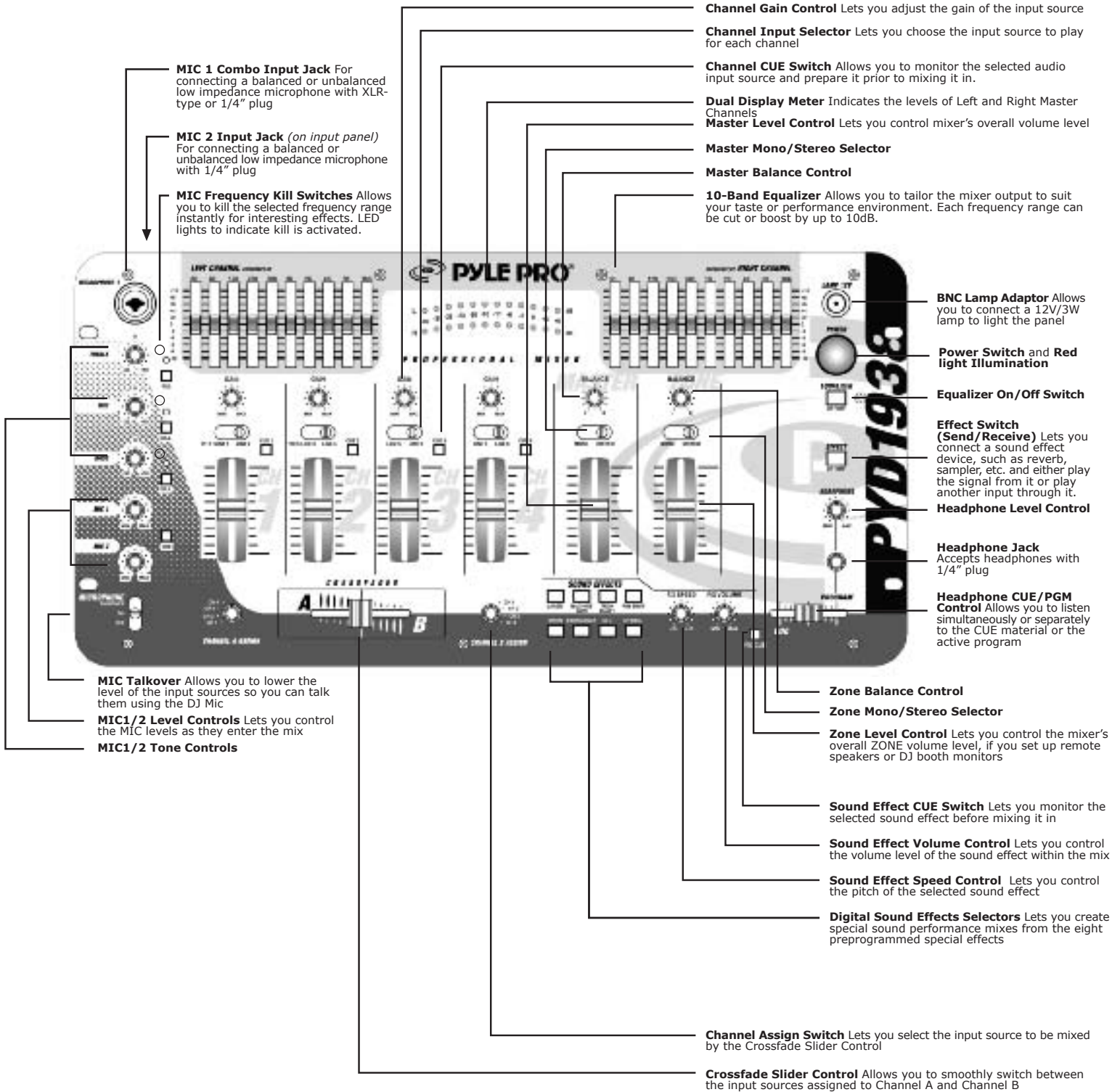

Features and Controls: PYD1948 Mixer

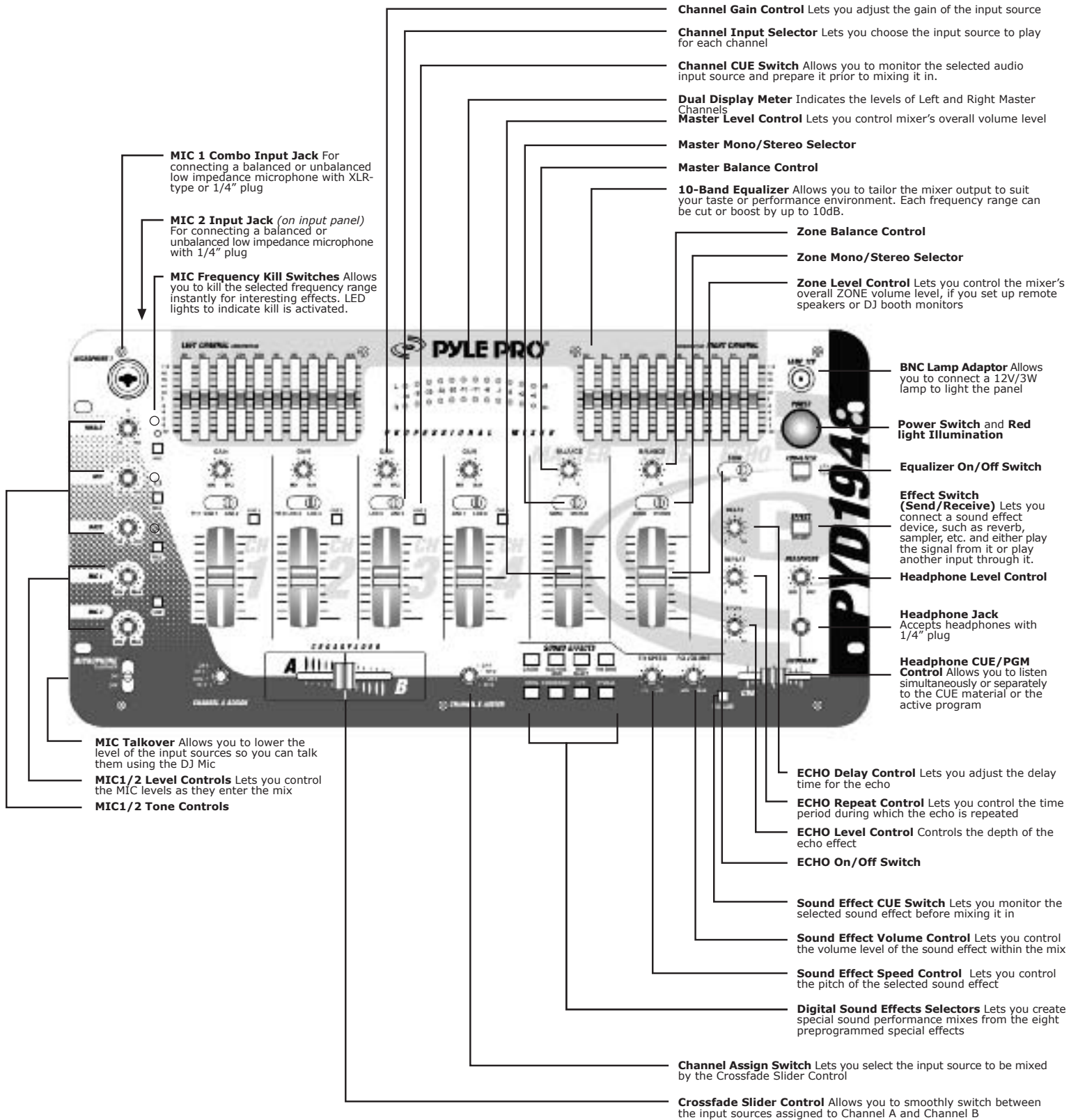

MIC 1 Combo Input Jack For connecting a balanced or unbalanced low impedance microphone with XLR-type or 1/4" plug

MIC 2 Input Jack (on input panel) For connecting a balanced or unbalanced low impedance microphone with 1/4" plug

MIC Frequency Kill Switches Allows you to kill the selected frequency range instantly for interesting effects. LED lights to indicate kill is activated.

MIC Talkover Allows you to lower the level of the input sources so you can talk them using the DJ Mic

MIC1/2 Level Controls Lets you control the MIC levels as they enter the mix

MIC1/2 Tone Controls

Channel Gain Control Lets you adjust the gain of the input source

Channel Input Selector Lets you choose the input source to play for each channel

Channel CUE Switch Allows you to monitor the selected audio input source and prepare it prior to mixing it in.

Dual Display Meter Indicates the levels of Left and Right Master Channels

Master Level Control Lets you control mixer's overall volume level

Master Mono/Stereo Selector

Master Balance Control

10-Band Equalizer Allows you to tailor the mixer output to suit your taste or performance environment. Each frequency range can be cut or boost by up to 10dB.

Zone Balance Control

Zone Mono/Stereo Selector

Zone Level Control Lets you control the mixer's overall ZONE volume level, if you set up remote speakers or DJ booth monitors

BNC Lamp Adaptor Allows you to connect a 12V/3W lamp to light the panel

Power Switch and Red light Illumination

Equalizer On/Off Switch

Effect Switch (Send/Receive) Lets you connect a sound effect device, such as reverb, sampler, etc. and either play the signal from it or play another input through it.

Headphone Level Control

Headphone Jack Accepts headphones with 1/4" plug

Headphone CUE/PGM Control Allows you to listen simultaneously or separately to the CUE material or the active program

ECHO Delay Control Lets you adjust the delay time for the echo

ECHO Repeat Control Lets you control the time period during which the echo is repeated

ECHO Level Control Controls the depth of the echo effect

ECHO On/Off Switch

Sound Effect CUE Switch Lets you monitor the selected sound effect before mixing it in

Sound Effect Volume Control Lets you control the volume level of the sound effect within the mix

Sound Effect Speed Control Lets you control the pitch of the selected sound effect

Digital Sound Effects Selectors Lets you create special sound performance mixes from the eight preprogrammed special effects

Channel Assign Switch Lets you select the input source to be mixed by the Crossfade Slider Control

Crossfade Slider Control Allows you to smoothly switch between the input sources assigned to Channel A and Channel B

Features and Controls: PYD1958 Mixer

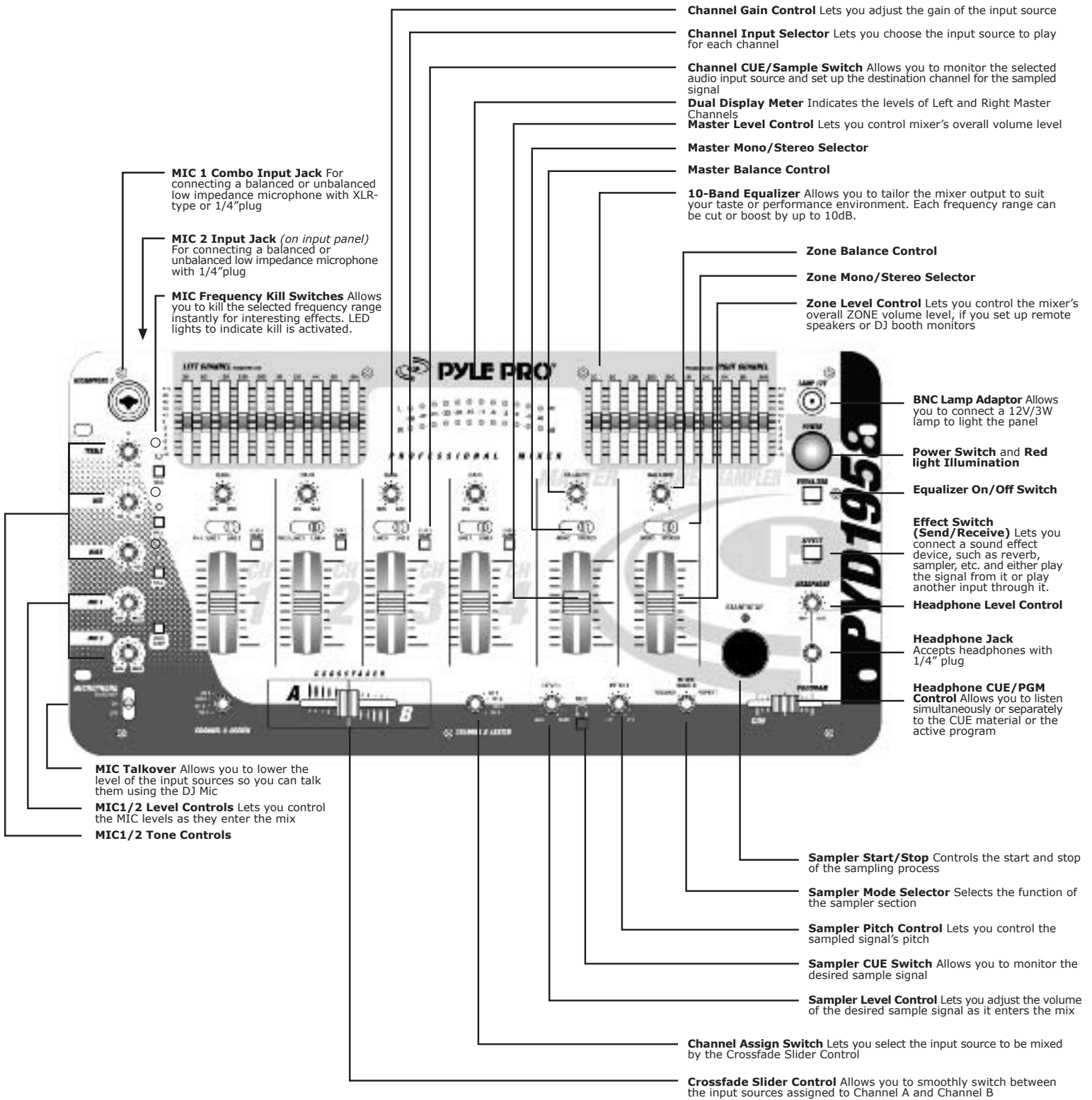

Presetting the Controls Before Use

Since sudden high output levels from your Pyle Pro mixer can damage not only audio devices connected to the mixer output but your hearing as well (especially if you are using headphones), please adjust the mixer's controls **BEFORE** connecting AC power or turning on the unit.

Set up the mixer controls like this before you start:

CONTROL	SETTING
Power On/Off	OFF
Balance	MID
Gain	MID
Tone Controls, Treble, Mid & Bass	0
MIC 1/2, CH 1/2/3/4, Master & Cue Levels	0
Crossfader	CENTER

Connecting the Mixer Inputs

This mixer permits connection of up to eight (8) audio input sources, and two microphones. Such a system might include, for example:

Two Microphones
Two Turntables
Six CD players

Two Microphones
Eight CD players

Two Microphones
Two Turntables
Three CD players
Three Cassette Decks

Two Microphones
Two Turntables
Four CD players
One Rhythm Synth
One Cassette Deck

Please observe the following:

Do not connect any audio source with a HIGH LEVEL OUTPUT to the LOW LEVEL PHONO 1 or PHONO 2 mixer audio input jacks (an audio source output with a volume control is HIGH LEVEL).

Connecting Microphones

Microphone 1. Connect a balanced/unbalanced low impedance (600 Ohm) XLR type mic OR a low impedance mic with a 1/4" plug to the MIC 1 jack in the upper left corner of the mixer control panel.

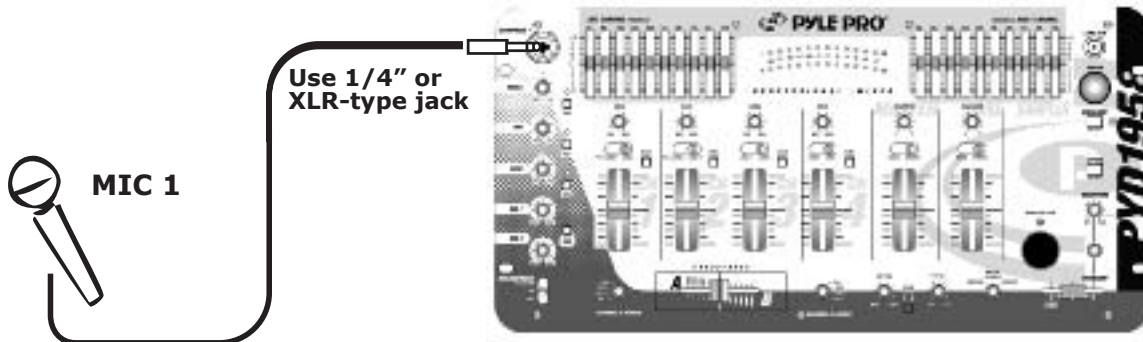

Microphone 2. Connect a high quality balanced/unbalanced low impedance (600 Ohm) microphone with a 1/4" plug to the MIC 2 jack on the lower left corner of the mixer's back panel.



Connecting High Level Output Audio Sources

Connect up to 8 such sources (tuner, cassette deck, CD Player, camcorder or VCR) to the input jacks for Line 1 (if not being used as Phono 1 input), Line 2, Line 3 (if not being used as Phono 2 input), Line 4, Line 5 and Line 6. Please note that Phono 1 and Line 1 (as well as Phono 2 and Line 3) use the same jacks. The selector switch(es) below the jacks should be set to Line position if the jacks are used for the High Level input sources described here.

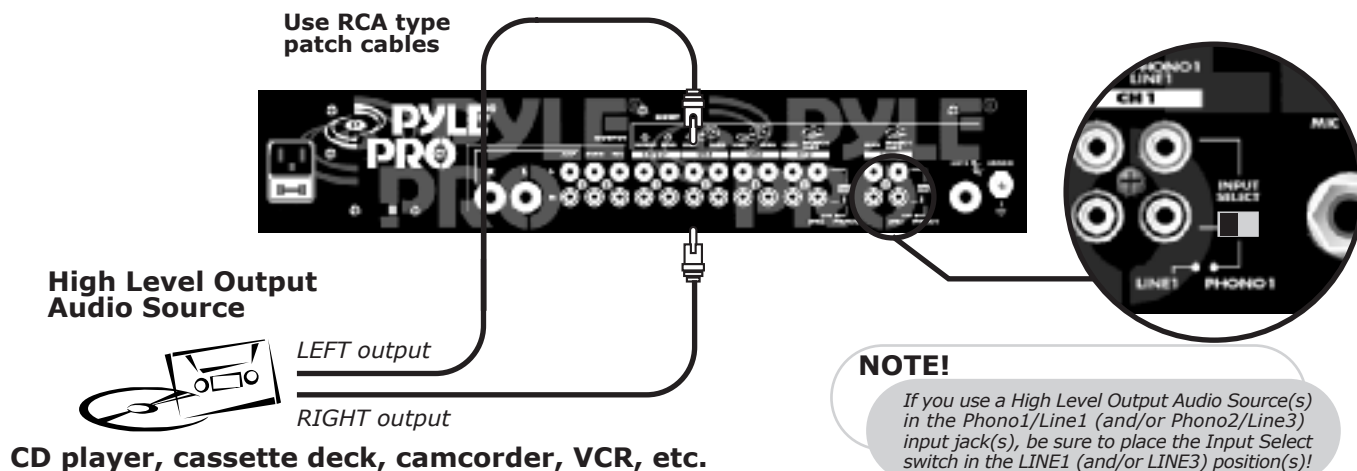

Connecting Turntables and Other Level Output Audio Sources

Connect up to 2 turntables to the Phono 1 and Phono 2 input jacks. Please note that Phono 1 and Line 1 (as well as Phono 2 and Line 3) use the same jacks. The selector switch below the jacks should be set to Phono position if the jacks are used for phono inputs.

When using a turntable, you should also securely connect its ground wire (usually green or black) to the Ground screw on the input panel of the mixer.

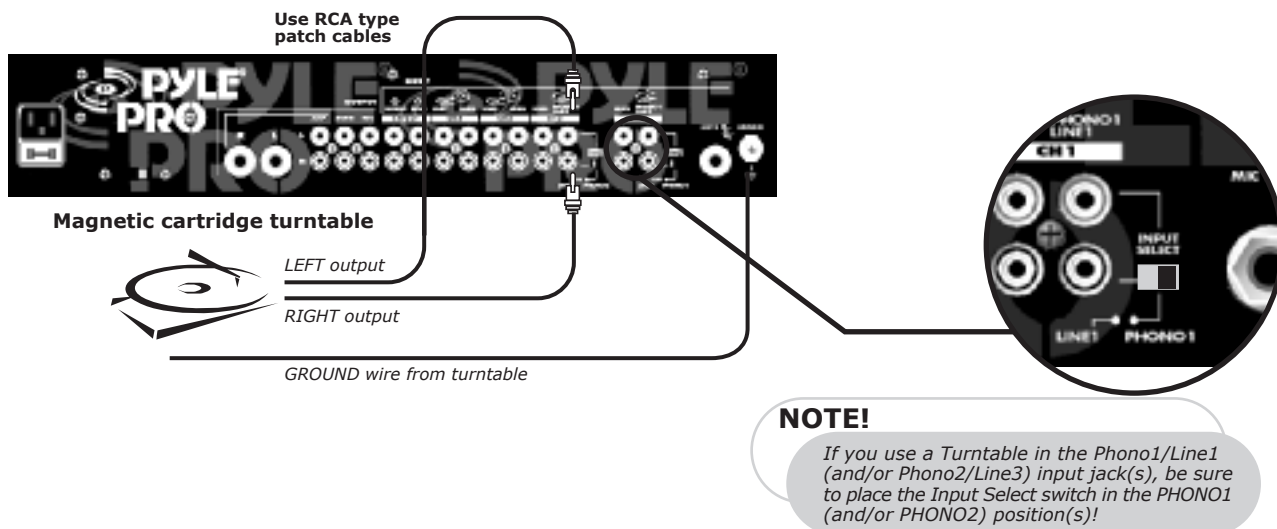

Using the Channel Input Gain Controls

Adjusting the Gain controls for each channel permits you to fine tune the level of each of the audio inputs, since input levels usually vary. Rotate the Gain controls clockwise to increase levels. After you preset the gain levels for each input, it is recommended that you do not adjust them further, as you can cause sound level imbalances during a mix.

Connecting the Mixer Outputs

Output to an Amplifier

To play the mixer's output signal through your speaker system (for events such as parties, dances, conferences, etc.) connect an audio patch cord (not supplied) from the mixers AMP L and R jacks to your receiver amplifier's left and right input jacks.

This mixer features two kinds of output jacks for you to choose from: RCA style and 1/4" type. DO NOT USE BOTH SIMULTANEOUSLY.

Output to a Tape or Digital Audio Recorder

To play the mixer's output signal through your speaker system (for events such as parties, dances, conferences, etc.) connect an audio patch cord (not supplied) from the mixers REC L and R jacks to your receiver/amplifier's left and right input jacks.

Zone Output

To monitor the mixer output to a second set of speakers in the DJ booth (or in a remote location) connect an audio patch cord (not supplied) from the mixers ZONE L and R jacks to your secondary amplifier's left and right input jacks.

CAUTION: In order to avoid sudden unpleasant sound output, adjust the output devices controls to these settings before you connect the mixer's output jacks to these devices' input jacks.

OUTPUT DEVICE	CONTROL	SETTING
Tape Deck	POWER	OFF
Amplifier/Receiver	POWER	OFF
	TONE	FLAT

Using Headphones

Plug a pair of stereo headphones (not supplied) with a 1/4" jack into the Phones input. Using headphones not only affords you the opportunity to listen privately, but also enables you to monitor ("cue") the incoming audio sources so you can locate an exact passage or section before mixing it in. It also gives you the opportunity to set up the relative volume level of the upcoming passage before it joins the mix.

Listen Safely! Please observe the following:

Do not listen at extremely high volume levels. Extended, high-volume listening can lead to permanent hearing loss. Follow these guidelines to protect your hearing, especially when using headphones.

Always start by setting the volume level to the lowest possible level before listening.

Put headphones on, and then gradually increase the volume as necessary.

Once you set the volume level do not increase it. Over a period of time, your ears adapt to a volume level and there is a temptation to increase it. Even though such an increase may not cause discomfort, it might still damage your hearing.

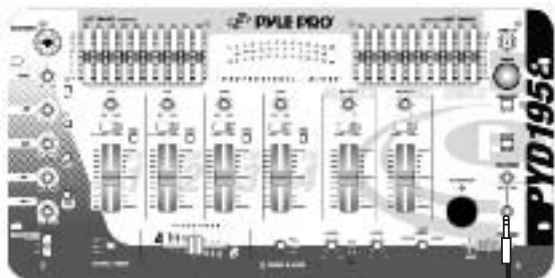

Stereo Headphones

Connecting the Lamp

If you wish to install a console lamp (not supplied), simply insert the plug end of an appropriate 12V/3W gooseneck style or similar lamp into the lamp socket provided in the upper right corner of the mixer control panel. Power is supplied to this lamp when the mixer power switch is turned on.

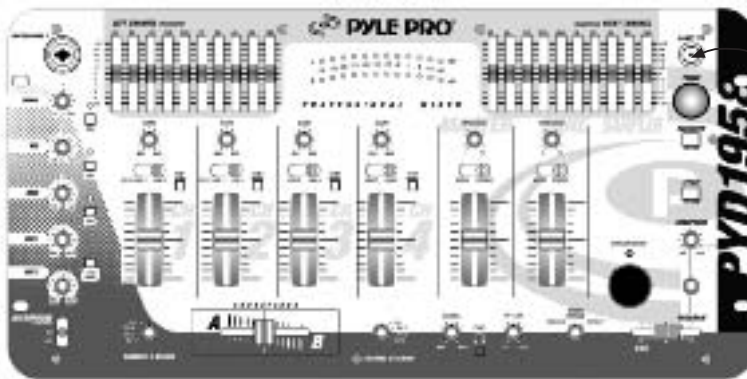

12V/3W lamp

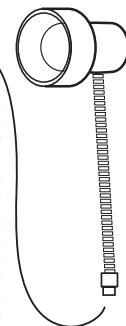

Using the Mixer Controls

Turning on the Mixer

1. Turn on the output amplifier and temporarily set its volume to the minimum setting.
2. On the mixer, turn ON the power switch. The adjacent power LED will illuminate.
3. Turn on the audio input sources you wish to mix, and set them to play (or talk continuously into the microphone).
4. To monitor the audio input sources so that you can decide when to mix in each input, see "Monitoring 'Cueing' the Inputs."
5. To mix the audio input sources so that you can play them through your amplifier system or record them on your tape deck, see "Mixing the Inputs."

Monitoring ("Cueing") the Inputs

1. Set the CUE ASSIGN switch of the input source (MIC , CH1, CH2, CH3 or CH 4) you wish to monitor.
2. Adjust the Headphone Level control to a comfortable listening level.
3. The Headphone CUE/PGM control permits you to switch easily from listening to CUE material to the playing PROGRAM sound. You can also listen to both simultaneously by moving the Headphone CUE/PGM control to a point midway between the two ends.

PYD-1938 and PYD-1948: These models also have an F/X CUE for you to monitor the sound effect being applied.

PYD-1958: This model has an additional CUE on the sampler module for you monitor the sampled signal being applied. To monitor a sampled signal, press the SAMPLE ASSIGN button for the channel to which the sample has been saved, and then press the SAMPLE CUE button to audition this sound.

Mixing the Inputs

There are a maximum of ten input sources available at one time, including two microphone inputs. Both microphone input sources are always available as part of the mix, if desired. Each of the four audio channels can be linked to two different input sources, and one of these sources for each channel is available for mixing. Turn on all the available audio sources and be sure they are providing sound before continuing.

1. Select the Channel Input Selectors for each channel, choose the audio sources you want to mix for each channel (i.e., choose PHONO1/LINE1 or LINE2).
2. Set the Mic and Channel Level controls all to within the 8 - 10 range.
3. Slide the MASTER volume control toward 10 until you get an average reading of 0 on both Output Level LED Meters. The output level displayed in the meters represents the TOTAL output from all the channels supplying audio to the mix. NOTE: Once you set this level, we suggest you do not change it!
4. If you add or change input sources, adjust the corresponding MIC1, 2 or CH1, CH2, CH3 or CH4 level control(s) to maintain the average reading of 0 on the Blue LED meters.
5. To change the overall sound level, adjust the RECEIVER/AMPLIFIER (NOT THE MIXER) volume control to the desired volume.

Adding Equalization to the Mix

You can further tailor the sound processed through the mixer to match your acoustic surroundings or suit your personal preferences by using the ten frequency sliders for each channel. To engage the equalization module, press the Equalization On/Off Switch. The LED next to the switch will be illuminated, indicated the EQ mode has been engaged.

Each one of the sliding controls boosts or cuts the selected frequency by up to 10 dB. If you leave a slider at the center ("0") position, the corresponding frequency range for that stereo channel will be left unaffected ("flat"). Please note that in order to provide a smooth range of control, the frequency ranges overlap slightly. Therefore, for example, if you raise the level in the 2K range, the 1K and 4K ranges are also slightly affected.

Adding External Effects to the Mix

To connect a sound effect device such as an echo reverb or digital sampler processor, first connect the EFFECTS SEND jacks to the external device's AUDIO IN jacks using RCA type cables. Then connect the device's audio outputs to the EFFECTS RECEIVE jacks on the mixer.

To activate the loop with which now has an outboard processor, press the Effects Switch. The effect devices are now in the audio chain. Be sure the device is ON.

Using the Microphone

Incorporating Voice into the Mix

To blend voice from the microphones with the audio program material, first be sure the MIC/TALKOVER switch is set to the ON position. (In this position, the MIC channel is mixed into the program like any other audio input source.)

Then adjust the corresponding MIC level controls to increase or decrease the microphone level (this will not affect the main volume inputs). When a microphone is not in use, set the MIC/TALKOVER switch to OFF.

Talkover Mode

Talkover mode allows a voice to be heard clearly through the microphone by attenuating all the other audio input sources. This mode is engaged by setting the Talkover Switch to the TALKOVER position.

Microphone Tone Controls

These BASS, MID and TREBLE controls, permit you to tailor the tone frequencies of the MIC inputs processed through the mix. Left in their center positions, the sound is unaffected ("flat").

Microphone Level Controls

The independent MIC1 and MIC2 controls permit you to increase or decrease the levels of these microphones within the mix.

Using the MIC Frequency Kill Switches

For unique circumstances or interesting special effects, you can completely eliminate the bass, mid or treble frequency range from the MIC channels by pressing the Kill button for that range. When the Kill mode is active, the LED above the button will be illuminated.

Using the Mono/Stereo Mode Switch

When the MASTER MONO/STEREO switch is in the MONO position, the mixer combines the right and left channels and sends them to the OUTPUT R and L jacks. These combined outputs can be used by a monoaural amplifier, such as a PA amp.

In the STEREO position, right and left channels remain separate. The mixer outputs can be used by a stereo amplifier or recorder.

The ZONE MONO/STEREO switch works similarly, except that its setting affects the ZONE R & L Outs.

Using the Crossfader with the Assign Switches

For crossfading effects, you can assign any of the four channels to either A or B sides of the crossfade mix using the Crossfade assign knobs.

When the crossfade slider is in the center position, the two assigned channels play equally. Sliding the control towards the A position will increase the level of A and fade out B proportionally to the distance from center. Likewise, sliding the control towards the B position will increase the level of B and fade out A.

Using the Echo Controls (PYD-1928 and PYD-1948)

The built-in Echo effect is applied to the total mix. To turn on the Echo mode and activate the DELAY/REPEAT cycle, press the ECHO ON/OFF switch.

To change the length of time a sound is repeated, increase or decrease the REPEAT control.

To vary the time in between the repeats, increase or decrease the DELAY control.

To adjust the output level of the echo, increase or decrease the LEVEL control.

Using the Sound Effects (PYD-1938 and PYD-1948)

There are eight pre-programmed sound effects for your selection. Press and hold any button to generate a sound which is added to the mix. The sound will play continuously until you release the button.

The SPEED control lets you raise or lower the pitch of the sound effect, and the VOLUME control allows you to increase or decrease the effect's volume level within the mix.

Using the Digital Sampler (PYD-1958)

The PYD-1958 mixer contains a digital sampler circuit which can record 5 different samples to the internal recording IC. These samples can then be assigned to CH 1, CH 2, CH 3, CH 4 and the MIC channel for playback. At the time of playback, the SPEED control can be adjusted to change the pitch of the sample.

Follow these steps to record a sample:

1. Play the audio source for recording as a sample.
2. While it is playing, press the desired cue/sample channel assign button (i.e., CH 1, CH 2, CH 3, CH 4 or MIC).
3. **To record** the source to that channel, set the SAMPLER MODE switch to the RECORD position and press the START/STOP button to begin recording. The LED will go on, indicating recording is in progress. To stop recording, press the START/STOP button again. Please note that the recording IC is limited to 12-second samples, so in the event you do not press stop, it will automatically stop after 12 seconds

- To playback the recorded sample ONCE**, turn the SAMPLER MODE switch to SINGLE, and press START/STOP. The LED will go on, indicating that a sample is playing. Pressing START/STOP during playback will stop the playback.

Each time you press the START/STOP control, the unit will replay the recorded sample from the beginning and play it through the end of the recorded sound. Rapid, consecutive pressing of the START/STOP button will create an interesting stuttering effect.

- To playback the record sample repeatedly ("looping")**, set the SAMPLER MODE switch to REPEAT, and press START/STOP. The mixer will play the sampled recording all the way through, and then repeat it until you press the START/STOP button.
- To adjust the speed of the playback signal**, rotate the SAMPLE PITCH control to reduce or increase the pitch of the sample during playback.
- To adjust the level of the sample playback** as it enters the mix, rotate the SAMPLE LEVEL to increase or decrease the level.

Troubleshooting

Your mixer should require very little maintenance. If you have problems, refer to the chart below for possible solutions. If you cannot solve the problem, contact a qualified technician for assistance.

PROBLEM	POSSIBLE SOLUTION
Nothing works	<ul style="list-style-type: none"> • Check the AC connection. Make sure the AC outlet is "live." • Check the power connection to the rest of the system (receiver/amplifier, etc.)
No signal from an audio input source	<ul style="list-style-type: none"> • Check the control setting • Check the connection between the mixer and the input source
Hum from PHONO	<ul style="list-style-type: none"> • Check that the turntable's ground wire (usually black or green) is fastened securely to the GROUND SCREW on the mixer input panel
Hum from other source	<ul style="list-style-type: none"> • Make sure there are no low level inputs connected to the LINE input jacks
Feedback is present	<ul style="list-style-type: none"> • Move the microphone further away from the output speakers, or use a directional microphone

Care and Maintenance

Your Pyle Pro Mixer is an example of superior design and craftsmanship. The following suggestions will help you care for your mixer so you can enjoy years of use:

- Keep the mixer dry. If it gets wet, wipe immediately.
- Use the mixer only in well-ventilated installations.
- Handle the mixer gently and carefully - do not drop!
- Keep the mixer away from dust and dirt.
- Wipe occasionally with a damp cloth to keep it looking new. Do not use harsh chemicals, solvents or detergents!

Pyle Pro Mixer Owner's Manual -13

▼ Please complete warranty card, detach and return ▼

Place
Stamp
Here



Specifications

PYD1918/1928/1938/1948/1958

Input Sensitivity/Impedance

Mic 1-2	1.5 mV/600 Ohms, bal/unbal
Phono 1-2	3.0 mV/50K Ohms
Line 1-8	150.0 mV/27K Ohms

Output Level

Amp	2.0 V/10-kOhms
Zone	2.0 V/10-kOhms
Record	150mV/10-kOhms

Frequency Response 20Hz - 20kHz +/- 3 dB

S/N Ratio (at 1 kHz)

Mic	>60 dB/1.5mV input
Phono	>70 dB/3.0mV input
Line	>80 dB/150.0 mV input

Distortion

Mic	0.20%
Phono	0.05%
Line	0.03%

Equalizer

Control Frequencies 30, 60, 120, 250, 500
1K, 2K, 4K, 8K, and 16KHz

Boost/Cut Range +/- 10 dB from center

MIC Tone Control

Treble	10kHz; +10/-30dB
Mid	1 kHz; +10/-30dB
Bass	100Hz; +10/-30dB

Talkover Attenuation -16dB

Echo Delay Time 50mS-120mS
(PYD-1928/1948)

Sampling Length 12 Seconds
(PYD-1958)

Power Source 120 VAC, 60Hz/230 VAC, 50 Hz

Dimensions, inches 19.0 x 4.13 x 9.45
(mm) (482 x 105 x 240)

Limited Warranty

All PYLE PRO products are carefully constructed and tested before shipment. Units purchased in the USA are warranted to be free of defects in material and workmanship for two (2) years from the date of purchase. This warranty is limited to the original retail purchaser of the mixer.

Should the unit fail due to factory defects in material or workmanship, your unit will be repaired or replaced at the sole discretion of PYLE.

To obtain warranty service, you must first call our Consumer Return Hotline at (718) 236-6948 to obtain a Return Authorization Number. This R.A. # must appear on the outside of your package and on all paperwork relating to your return.

When returning the unit to us for warranty service, it must be carefully packed and shipped, prepaid, to:

R.A.#: _____
PYLE PRO Service Center
1600 63rd Street
Brooklyn, NY 11204

You must also include the following items with your return:

- A copy of your sales receipt or other proof of purchase
- A brief letter, indicating the problem you are experiencing with the product
- Include in your letter your return address, daytime phone number and R.A. number
- Also include a check or money order for \$20.00 for return shipping, handling and insurance, or provide your Visa/MC number with expiration date.

Our obligation under this warranty is limited to the repair or replacement of the defective unit when it is returned to us prepaid. This warranty will be considered void if the unit was tampered with, improperly serviced or subject to misuse, neglect or accidental damage.

▼ Please complete warranty card, detach and return ▼

Thank you for purchasing this PYLE product. To activate your warranty, please mail this card within 10 days.

warranty registration card

PYLE PRO
PYLE PRO MIXERS

Name _____

Address _____

City, State ZIP _____

Model No. _____

Serial # (if available) _____

Date of Purchase _____

Purchased at:

- Music Products Store
 Sound Contractor/Installer
 Mail Order
 Catalog Merchandiser
 Other _____

www.pyleaudio.com

14 - Pyle Pro Mixer Owner's Manual

Free Manuals Download Website

<http://myh66.com>

<http://usermanuals.us>

<http://www.somanuals.com>

<http://www.4manuals.cc>

<http://www.manual-lib.com>

<http://www.404manual.com>

<http://www.luxmanual.com>

<http://aubethermostatmanual.com>

Golf course search by state

<http://golfingnear.com>

Email search by domain

<http://emailbydomain.com>

Auto manuals search

<http://auto.somanuals.com>

TV manuals search

<http://tv.somanuals.com>