

Product Identification

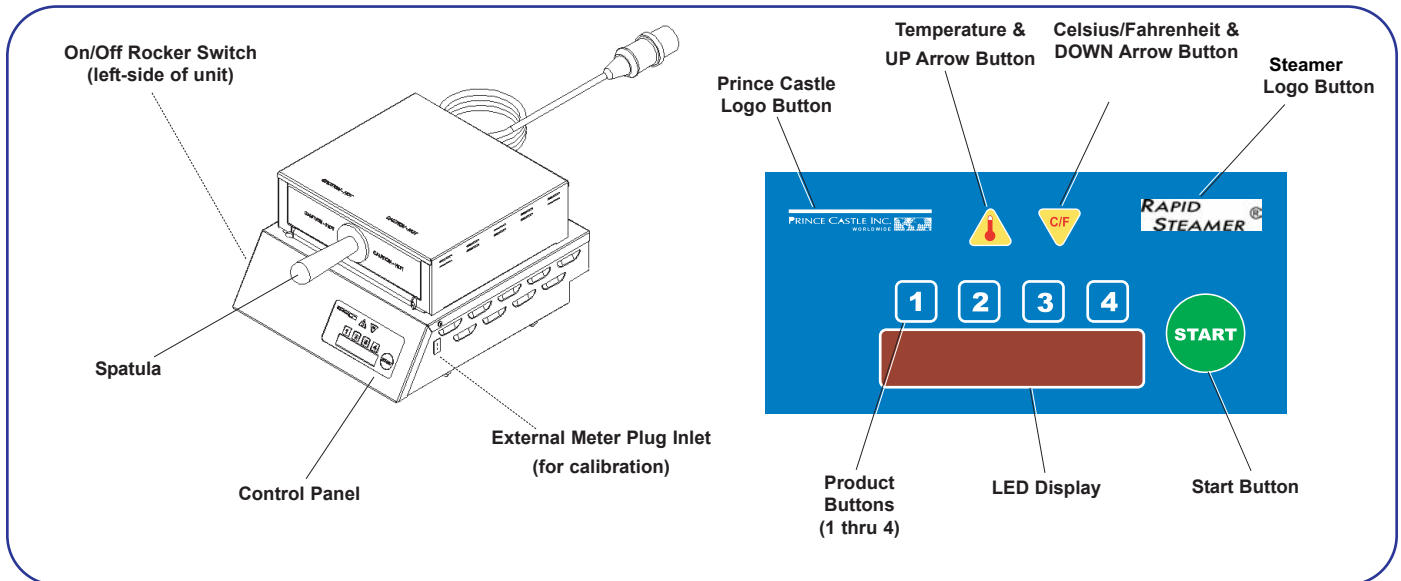

LIMITED WARRANTY

This product (with the exception of the water tube, part no. 625-197S) is warranted to be free from defects in material and/or workmanship for a period of two (2) years from date of original installation, not to exceed 30 months from date of shipment from our factory. P.C. Boards and Heater Assemblies are warranted for three (3) years from date of installation, not to exceed 42 months from date of shipment. Any component which proves to be faulty in material and/or workmanship will be replaced or repaired (at the option of Prince Castle, Inc.) without cost to the customer for parts or labor. This warranty covers on location service (i.e. trip charges and/or mileage). Travel mileage is limited to 100 miles (200 kilometers) round trip (one trip warranty) from an authorized service agency or its sub-service agency.

This warranty is subject to the following exceptions/conditions:

- Use of any non-genuine Prince Castle parts voids this warranty.
- All labor shall be performed during regular work hours. Overtime premium will be charged to the buyer.
- Damage caused by carelessness, neglect, and/or abuse (e.g., dropping, tampering or altering parts, equipment damaged in shipment, by fire, flood or an act of God) is not covered under this warranty.

TABLE OF CONTENTS

Product Identification	1
Safety Information	2
General	2
Installation	2
Operation	2
Temperature Adjustment	3
View Firmware Version	3
Manual Reset	3
Programming Product Name & Water Cycle	4
Error Messages	5
Cleaning - Daily	6
Cleaning - Monthly	7
Exploded View and Parts List	8
Wiring Diagram	9



PRINCE CASTLE INC. 
 WORLDWIDE

355 East Kehoe Blvd. • Carol Stream, IL 60188
 Phone: 630-462-8800 • Toll Free: 1-800-PCASTLE
 Fax: 630-462-1460 • www.princecastle.com

Safety Information

WARNING

Indicates information important to the proper operation of the unit. Failure to observe may result in damage to the equipment and/or severe bodily injury or death.

CAUTION

Indicates information important to the operation of the unit. Failure to observe may result in damage to the equipment.

Important

Prince Castle reserves the right to change specifications and product design without notice. Such revisions do not entitle the buyer to corresponding changes, improvements, additions or replacements for previously purchased equipment.

Installation

Remove the unit from the carton and inspect for signs of damage. If there is damage to the unit:

- notify the carrier within 24 hours of delivery
- save carton and packaging materials for inspection purposes
- contact your local dealer, or if purchased directly, the Prince Castle Sales Department at 800-722-7853 or 1-630-462-8800 to arrange for a replacement unit.

WATER CONNECTION REQUIREMENTS

If this is a new installation, accessory - 625-104 Regulatory Assembly Kit is required. You may also need accessory part #625-103 Coil Hose Kit Assembly. Always use area codes for determination.

NOTE: When installing this unit, the ambient temperature at the mounting site should not exceed 37.8°C (100°F).

CAUTION

All electrical connections must be in accordance with local electrical codes and any other applicable codes.

Plug the unit into an applicable electrical receptacle. Connect the water line to the back of the unit.

CAUTION

Water connection must provide maximum water pressure of 20-30 psi (138-207 kPa).

Operation

- A. Turn unit power On/Off switch to ON position. The display flashes PRINCE CASTLE for ten seconds.

B. After ten seconds the display will show PR.E-HEAT.

NOTE: The next-to-left most decimal point appears indicating power is applied to the platen. Platen will heat to the setpoint temperature.

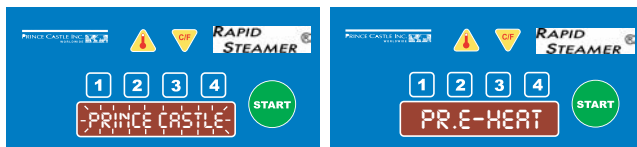

- A. When the unit reaches the setpoint temperature, display will show the product name assigned to button 1.

B. If 1 is the desired product to be steamed, pull out the spatula and place the product onto the spatula, cut side down.

Or press product buttons 2, 3 or 4, then place product on the spatula, cut side down.

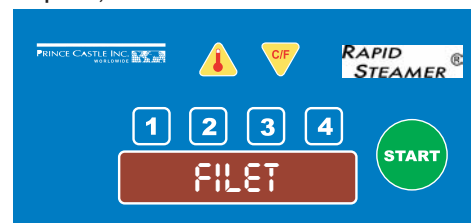

- Place the spatula fully into the unit and press the START button. The display will start to count down the steam cycle.

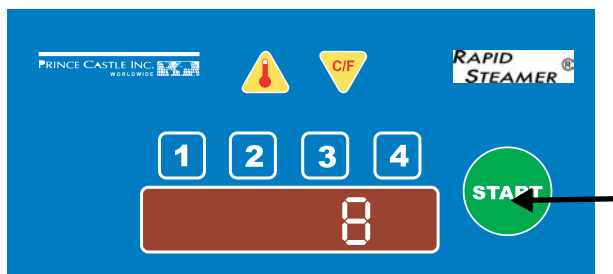

- When steam cycle is complete, the unit will sound a tone and the display will flash REMOVE. Pull out the spatula and remove the finished product.

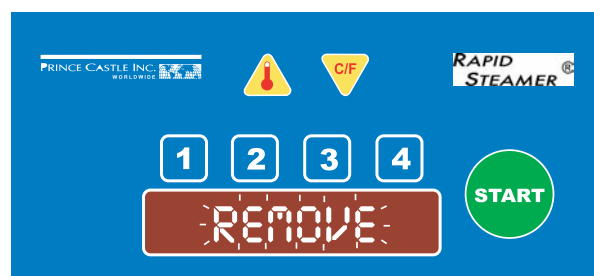

Temperature Adjustment

- A. Press and hold the TEMPERATURE button. The display will show the current temperature setting for Celsius (C) or Fahrenheit (F).

B. While holding the TEMPERATURE button, press the C/F button to change the setting between Fahrenheit and Celsius.

C. Release the TEMPERATURE button to store the new value.

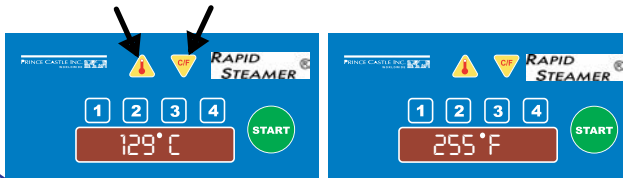

- A. Press and hold the Steamer LOGO button first, then press and hold TEMPERATURE button for approximately 6 seconds. The display will show SET TEMP.

B. Press the Steamer LOGO button again to display the current set temperature.

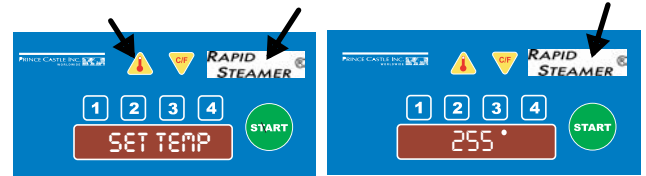

- Platen temperature can be set between 129°-152°C (265°- 305°F). Pre-set at factory to 140°C (285°F).

- Press the UP or DOWN Arrow buttons to scroll to the desired temperature.
- Press the Steamer LOGO button to store the desired temperature and exit the SET TEMP mode.

NOTE: Pressing the PRODUCT 3 button at any time exits the Program mode without storing the change.

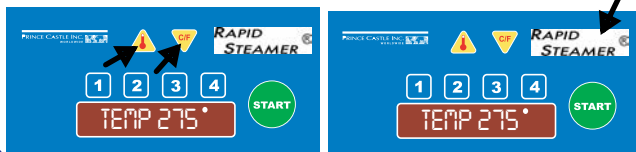

- The CAL TEMP mode is used to calibrate the platen temperature with an external meter connected to the meter plug inlet on the bottom right side of the unit. Add $\pm 5^{\circ}\text{C}$ ($\pm 10^{\circ}\text{F}$).

Repeat Step 2A

- Press the UP and DOWN Arrow buttons to scroll to CAL TEMP.
- Press the Steamer LOGO button again to display the current calibration temperature.
- Press the PRODUCT 2 button to zero any previous calibration offset value. The display will now show the platen temperature without any calibration offset.

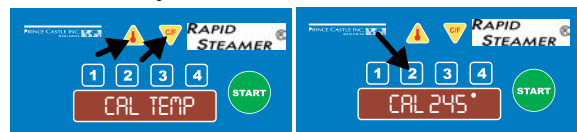

- A. Press the UP or DOWN Arrow buttons until the temperature readout matches the calibration reading.

B. Press the Steamer LOGO button to store the desired temperature and exit CAL TEMP mode.

NOTE: Pressing the Product 3 button at any time exits the Program mode without storing the change.

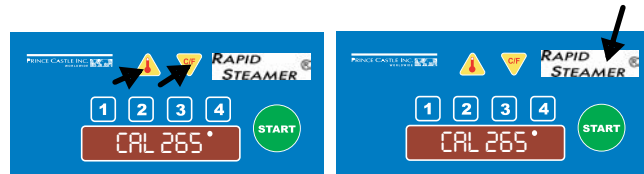

Factory Presets

Loading factory presets restores the unit to factory settings and voids all user programmed information.

- During power up, press and hold both PRODUCT 1 and PRODUCT 4 buttons within 3 seconds. The display will flash PRESETS LOADED.
- Release both buttons.

Default Factory Presets:

	ON	OFF	Cycles
All	1	3	2

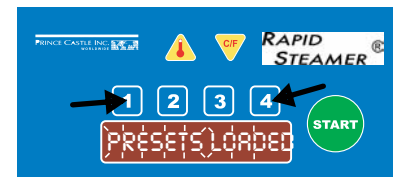

View Firmware Version

Press and hold the Steamer LOGO button first, then press and hold the START button. The display will show the current firmware version.

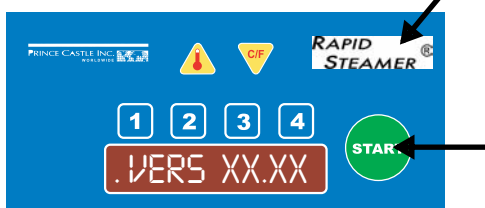

Manual Reset

A hi-limit thermostat will turn off electrical power to the platen and control circuits if the unit overheats.

Turn the unit off and allow to cool (approximately 10-15 minutes).

A manual reset is located on the back of the unit. Once the unit has cooled sufficiently, press the manual reset and restart the unit.

NOTE: If the unit continues to shut-off due to overheating, contact your authorized Prince Castle Service Agency.

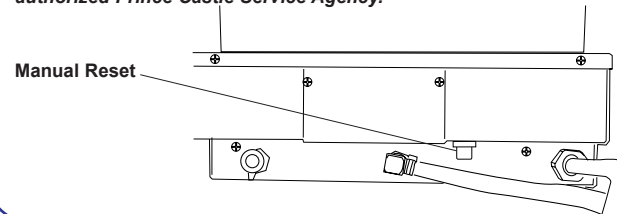

Programming Product Name & Water Cycle

The Program button menus can be changed to any of the following menu items.

PROD1 thru PROD12 can be selected to program additional product names.

"- - - -" can be used when no product name selection is desired.

File	Large	PROD1	PROD2	PROD3
PROD4	PROD5	PROD6	PROD7	PROD8
PROD9	PROD10	PROD11	PROD12	- - - -

- 1** A. Press and hold the LOGO button and a PRODUCT button for approximately 6 seconds. The display will show the current assigned product for the button pressed.

NOTE: A decimal point will appear and flash on the right side of the display to indicate Programming mode.

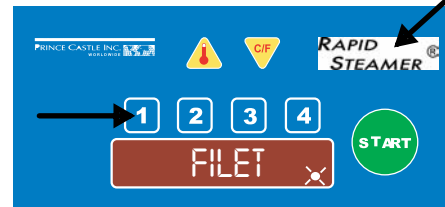

- 2** B. Press the UP or DOWN Arrow button to scroll through the product selections.

C. Press the Steamer LOGO button to store the new product name.

To enter custom product names, proceed to step 3.

NOTE: Pressing the Product 3 button at any time exits the Program mode without storing the change.

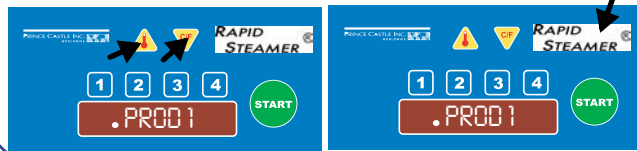

- 3** Press and hold the Prince Castle LOGO button first, then press and hold the Steamer Logo button for 6 seconds.

The display will show the product name with the left-most character display or decimal point flashing.

NOTE: Must be in Programming mode.



- 4** A. Press the UP or DOWN Arrow buttons to change the left-most character.
B. Press the Product 1 or Product 4 button to move the cursor to the next character.
C. Repeat steps A and B for each character.
D. Press the Steamer LOGO button to store the new product name.

NOTE: Pressing the Product 3 button at any time exits the Program mode without storing the change.

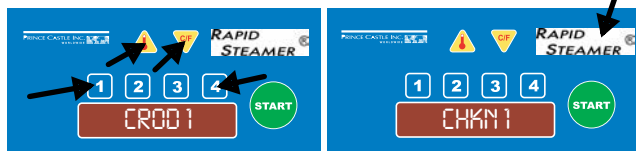

- 5** The display now shows the product's water valve ON time in seconds.



- 6** A. Press the UP or DOWN Arrow buttons to change the valve ON time.
B. Press the Steamer LOGO button to store the new valve ON time.

NOTE: Pressing the Product 3 button at any time exits the Program mode without storing the change.

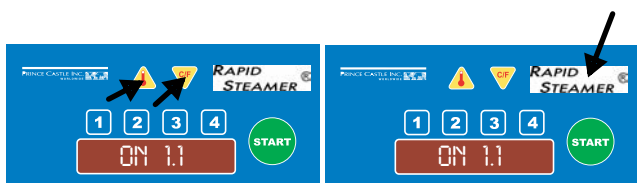

- 7** The display now shows the product's water valve OFF time in seconds.

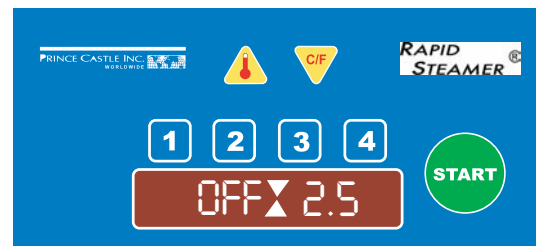

- 8** A. Press the UP or DOWN Arrow buttons to change the valve OFF time.
B. Press the Steamer LOGO button to store the new valve OFF time.

NOTE: Pressing the Product 3 button at any time exits the Program mode without storing the change.

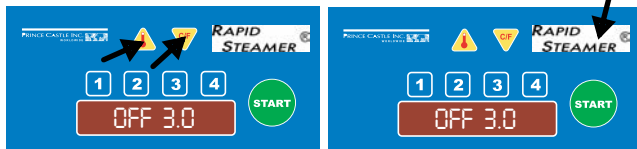

- 9** The display now shows the product's number of on-off water valve cycles.

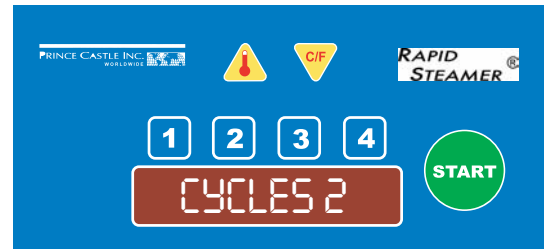

- 10** A. Press the UP or DOWN Arrow buttons to change the number of water cycles.
B. Press the Steamer LOGO button to store the new water cycle number and exit the Programming mode.

NOTE: Pressing the Product 3 button at any time exits the Program mode without storing the change.

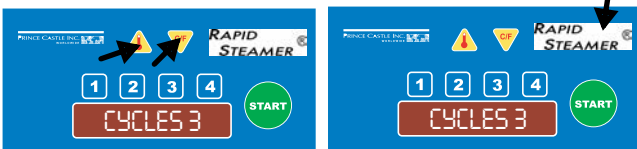

- 11** The display now shows the current product set temperature.

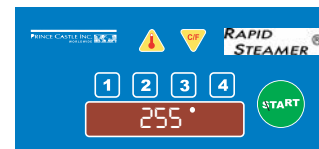

- 12** Platen temperature can be set between 129°-176°C (265°- 350°F).

- A. Press the UP or DOWN Arrow buttons to scroll to the desired temperature.
B. Press the Rapids Steamer LOGO button to store the desired temperature.

NOTE: Pressing the PRODUCT 3 button at any time exits the Program mode without storing the change.

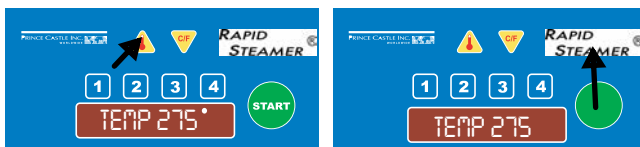

- 13** The display now shows the time delay between when the product is finished and when the alarm sounds. The delay can be set for 0.0 to 10.0 seconds.
A. Press the UP or DOWN Arrow buttons to scroll to the desired time delay.
B. Press the Rapid Steamer LOGO button to store the desired time and to exit the Programming mode. .

NOTE: Pressing the PRODUCT 3 button at any time exits the Program mode without storing the change.



Error Messages

ERROR MESSAGES	ACTION
No Heat Error.	Call service technician.

Cleaning - Daily PM Tasks

⚠ WARNING

Turn the unit off and unplug the power cord from the electrical receptacle. Proceed with caution, unit is still hot!

⚠ CAUTION

This unit is not watertight. Do not clean with a water jet/jet spray. Do not immerse the unit in water.

Do not use abrasive materials such as scrapers, steel wool, etc. to clean the spatula or steam chamber.

The following equipment is required:

- Detergent or Cleaner
- Delimer/Lime Scale Remover (as required)
- Sanitizer
- Clean sanitized towel
- Protective (insulated) gloves

- 1** While wearing protective gloves, remove the top cover by pulling up and off the unit.

Top Cover

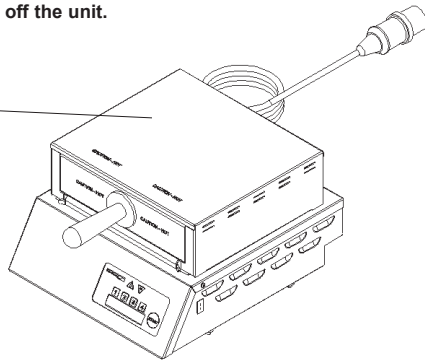

- 2** While wearing protective gloves:

- A. Remove spatula.
- B. Remove the top plate by carefully sliding it forward and out of the unit.
- C. Remove the venturi plate.

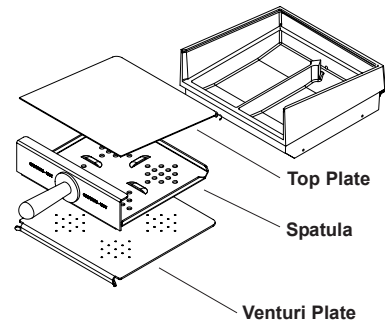

- 3**
- A. Wash top cover, top plate, and venturi plate in a solution of detergent and water.
 - B. Rinse with clean water, and then sanitize in a solution of sanitizer.
 - C. Let air dry.

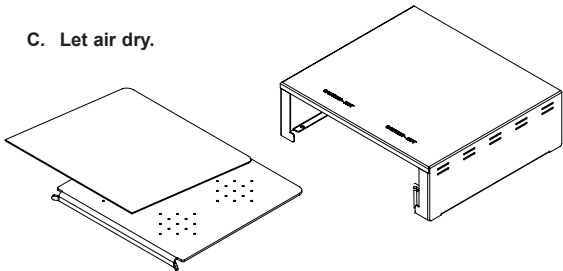

- 4** Wipe the steam chamber surface with a clean sanitized cloth.

OPTIONAL: If the surface shows signs of excessive calcium and lime buildup, dissolve two teaspoons of delimer in a small coffee cup with 100ml of water. Pour half on each side. Using a clean sanitized towel, wipe the internal surfaces of the steam chamber. Allow to sit for 5 minutes. Using a clean sanitized towel, thoroughly rinse and wipe, the internal surfaces of the steam chamber.

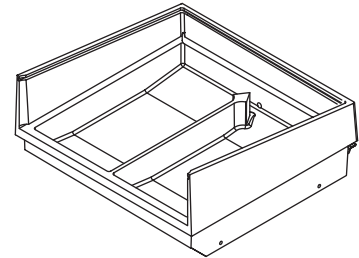

- 5** Wash all external surfaces of the steamer with a solution of detergent and water. Using the solution in a spray bottle, spray directly onto a clean sanitized towel and wipe the unit clean.

⚠ CAUTION

Do not spray directly on the unit or use abrasive cleaners!

- 6** Reassemble the unit. Turn the unit on. When unit is preheated, run a minimum of four cycles to prime the unit and remove any residual cleaner.

It is recommended that the steamers go through a deliming procedure at least once a month. Some hard water areas may require increased deliming based upon actual buildup.

Cleaning - Monthly PM Tasks

⚠ WARNING

Turn the unit off and unplug the power cord from the electrical receptacle. Proceed with caution, unit is still hot!

⚠ CAUTION

This unit is not watertight. Do not clean with a water jet/jet spray. Do not immerse the unit in water.

Do not use abrasive materials such as scrapers, steel wool, etc. to clean the spatula or steam chamber.

The following equipment is required:

- Detergent or Cleaning Solution
- Delimer/Lime Scale Remover (as required)
- Sanitizer
- Clean sanitized towel
- Protective (insulated) gloves

- 1** While wearing protective gloves, remove the top cover by pulling up and off the unit.

Top Cover

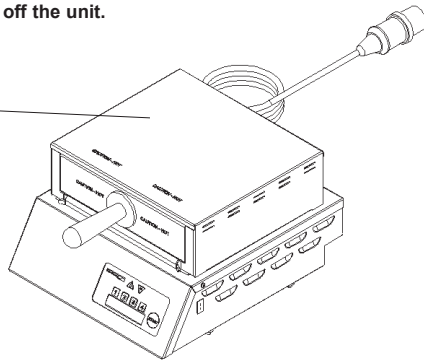

- 2** While wearing protective gloves:

- A. Remove spatula.
B. Remove the top plate by carefully sliding it forward and out of the unit.
C. Remove the venturi plate.

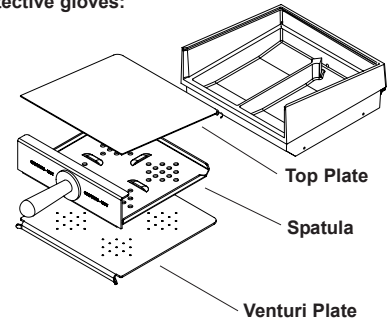

- 3** A. Wash top cover, top plate, spatula, and venturi plate in a solution of detergent and water.

B. Rinse with clean water, and then sanitize in a solution of sanitizer.

C. Let air dry.

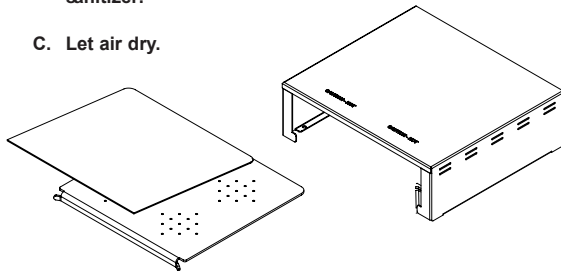

- 4** Pour a solution of Delimer into the steam chamber. Let solution soak for at least 15 minutes.

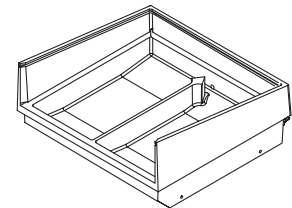

IMPORTANT. It is not recommended to leave open container of delimer around

- 5** A. Clean stem injection ports with a paper clip or small wire.
B. Rinse with clean water.
C. Wash all external surfaces of the steamer with a solution of detergent and water in a spray bottle. Spray directly onto a clean sanitized towel and wipe the unit clean.
D. Reassemble the unit.

⚠ CAUTION

Do not spray directly on the unit or use abrasive cleaners!

Exploded View and Parts List

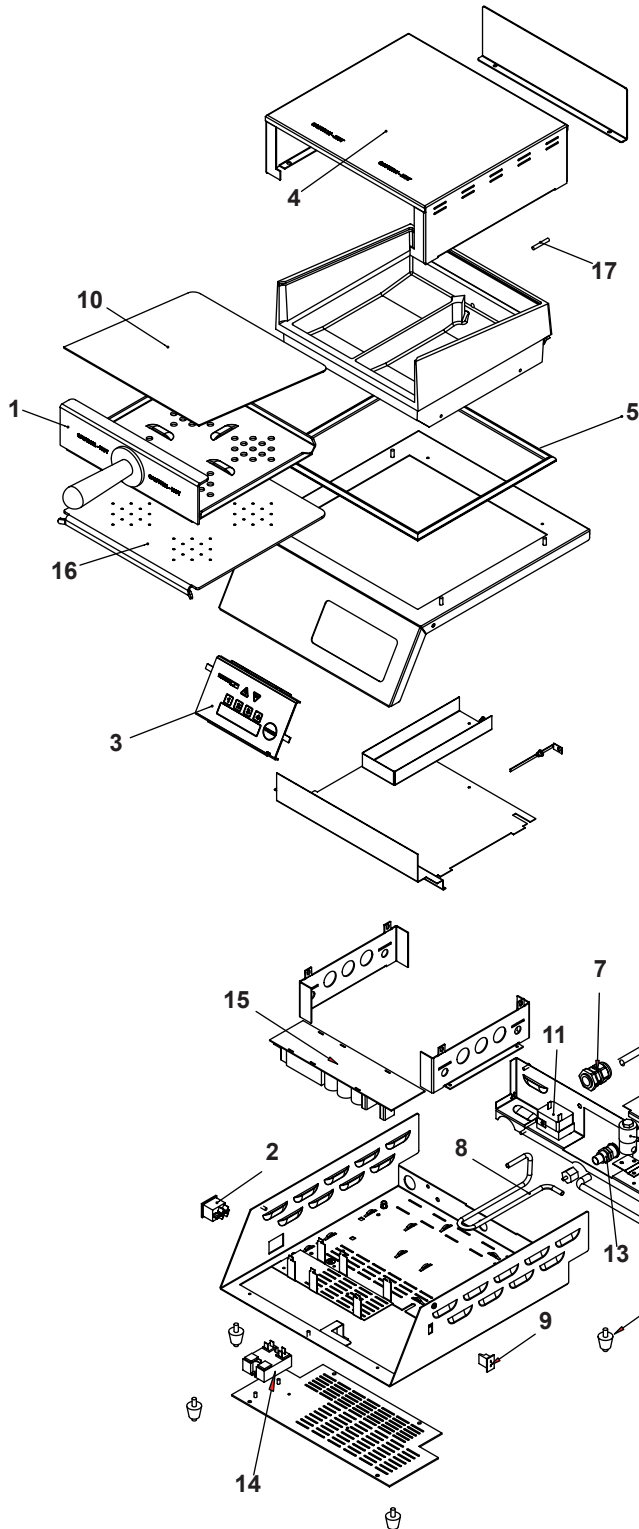

Ref.	Part No.	Description	Qty.
1	625-129S	Spatula Assembly	1
2	78-233S	Switch, Rocker, 20A	1
3	625-193S	Membrane Switch Assembly	1
	625-205S	Display PC Board	1
4	625-145S	Cover, Top	1
5	625-130S	Gasket, Silicone	1
6	197-232S	Legs (Pkg. of - 4)	1
7	66-045S	Strain Relief	1
8	625-071S	Tube, Water	1
9	88-497S	Mini-Jack, K-Type	1
10	625-064S	Top Plate	1
11	625-085S	Manual Reset	1
12	625-083S	Water Valve Assembly	1
13	625-077S	Fitting, Water Valve	1
14	65-059S	Relay, 40A	1
15	625-154S	Main PC Board	1
16	625-065S	Venturi Plate	1
17	625-082S	Probe, 1000 ohm RTD	1
18	72-365S	Line Cord Assembly	1
19		Plug included in 18	
6	86-255S	Legs, 1" High (Pkg. of 4)	1
7	66-061S	Strain Relief	1
18	72-379S	Line Cord Assembly	1

625 Accessories (not shown)

625-253S	Regulator Assembly Kit	1
----------	------------------------	---

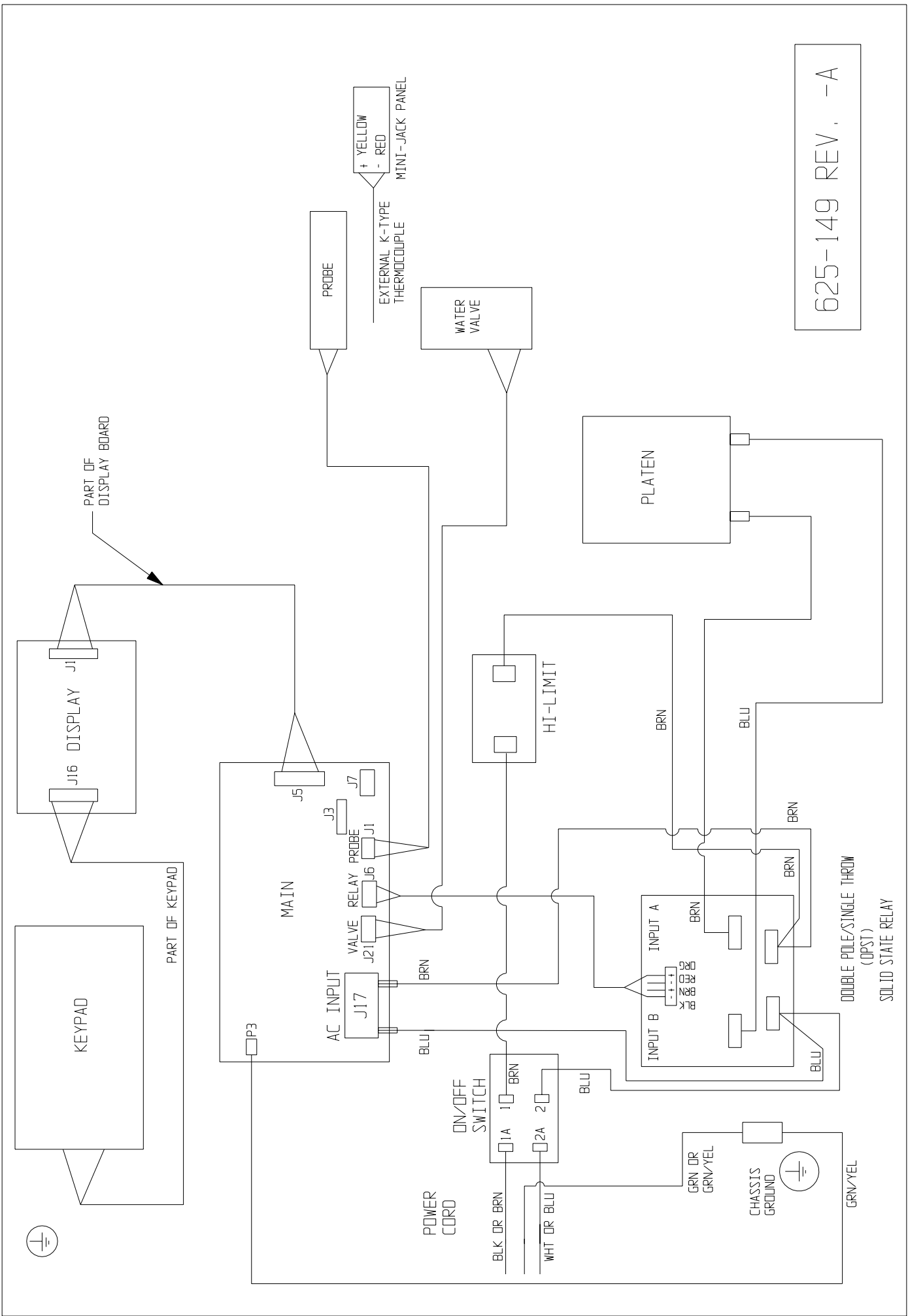

625-149 REV. -A

Free Manuals Download Website

<http://myh66.com>

<http://usermanuals.us>

<http://www.somanuals.com>

<http://www.4manuals.cc>

<http://www.manual-lib.com>

<http://www.404manual.com>

<http://www.luxmanual.com>

<http://aubethermostatmanual.com>

Golf course search by state

<http://golfingnear.com>

Email search by domain

<http://emailbydomain.com>

Auto manuals search

<http://auto.somanuals.com>

TV manuals search

<http://tv.somanuals.com>