

OWNER'S MANUAL



68CM CORDLESS REMOTE COLOUR TELEVISION
MODEL: 68CT8



Type Tested
Electrical
Safety
AS/NZS 3250 Lic 4166
Standards Australia
APP No: N15899

N.G ENTERPRISES PTY LTD
1 JOYNTON AVENUE
WATERLOO NSW 2017 AUSTRALIA
TEL: (02) 9313 7111
FAX: (02) 9313 7555
www.palsonic.com.au

N.G. ENTERPRISES PTY LTD
TELEPHONE
AUSTRALIA: 1300 657 888

Contents

Congratulations on your purchase of this Palsonic colour television.

We recommend that you thoroughly read this manual before use to fully enjoy the many functions and excellent effects of this equipment.

Retain this manual in an easily accessible location for future reference.

* Screen displays and illustrations in this manual may differ from the actual ones for better visibility.

Contents

| | |
|--------------------------------------|----|
| Main Features | 1 |
| Safety precautions | 2 |
| Identification of Controls | 4 |
| Antenna Connection | 6 |
| Preparing the remote control | 7 |
| External equipment connections | 8 |
| Power On/Off | 10 |
| Selecting Input Signal | 11 |
| Tuning in | 12 |
| Channel Selection | 15 |
| Channel Edit | 16 |
| Picture adjustments | 17 |
| Sound controls | 18 |
| Timer setting | 19 |
| System setup | 21 |
| Lock setting | 22 |
| Other functions | 24 |
| Troubleshooting Guide | 25 |
| Specifications | 27 |

Main features

- Hyperband
- Automatic channel preset
- Full function remote control
- 200 preset channels
- Intellectualized I²C-bus control
- AV input/output (RCA) jacks
- DVD input jacks
- Selectable picture
- ON timer/OFF timer/Sleep timer
- Channel scan
- Channel edit
- Child lock
- Hotel lock
- Game
- Calendar

Safety precautions

Note: This TV set can operate on an AC power of **240V, 50Hz**. You must not use a power supply of any other type.

- ◆ When any unusual situation occurs, turn off the power supply at once and remove the plug from the wall outlet. Contact a qualified service department in your local area.

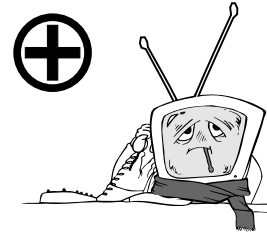

- ◆ Do not expose the TV set to rain or excessive moisture. Avoid using the set in very warm or damp places and never use it in a bathroom.



- ◆ When cleaning dust off the picture tube disconnect the power first. You can wipe lightly with a piece of dry, clean and soft cloth.

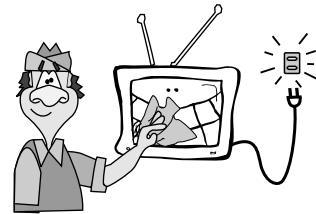

- ◆ Avoid exposing the set to direct sunlight and other sources of heat to prevent damage to the cabinet and components.

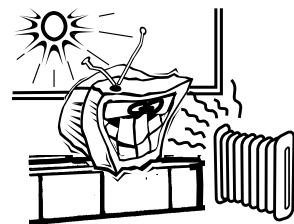

- ◆ High voltage exists in this TV set. Do not remove the cover.



Safety precautions

- ◆ *Do not cover the ventilating hole in the cabinet. Keep a space of more than 10cm from the walls to the TV set to ensure adequate ventilation.*

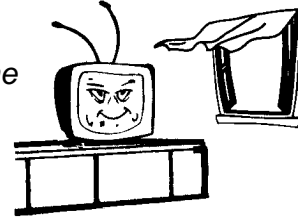

- ◆ *If the power cord or the plug is damaged contact a qualified service department for service.*

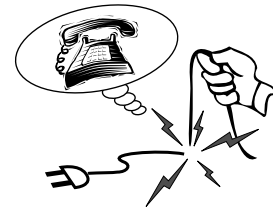

- ◆ *When the TV set is to be left unattended for a long period of time, turn off the power supply and remove the plug from the wall outlet.*

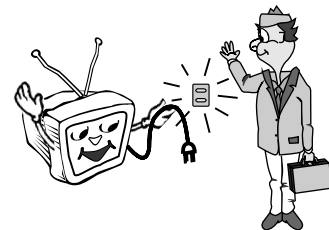

- ◆ *Don't try to push anything into the cabinet or place any vessel with water on the TV set.*

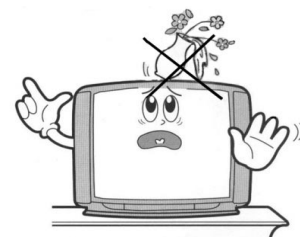

- ◆ *Don't overload wall outlets; extension cords, or integral convenience receptacles as this can result in a risk of fire or electric shock.*

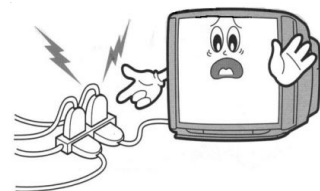

Identification of Controls

Remote control

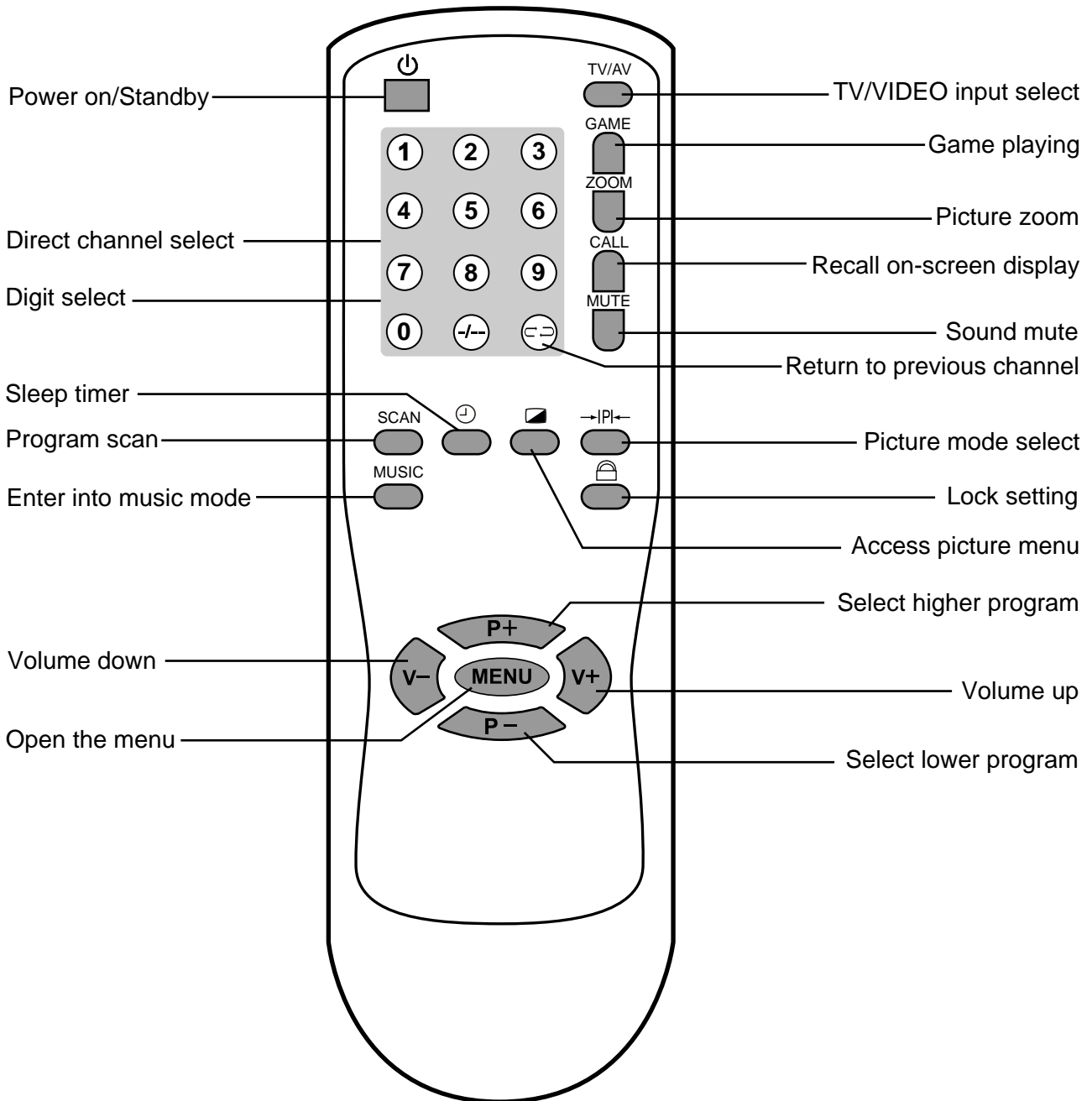

Antenna connection

Optimum reception of colour requires a good signal and will generally mean that an outdoor aerial must be used. The exact type and position of the aerial will depend upon your particular area.

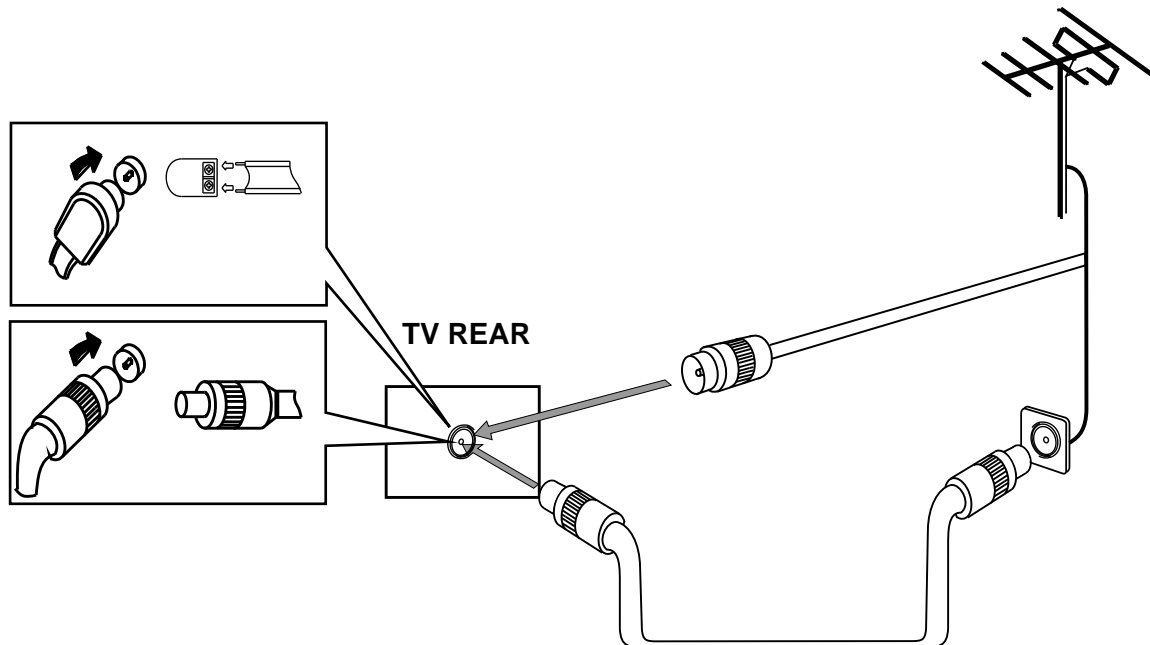

⚠ Notes:

- It is recommended that the 75-ohm coaxial cable be used to eliminate interference and noise which may occur due to radio wave conditions.
- The aerial cable should not be bundled with the power cord and the like.

INSTALL the unit in a room where direct light will not fall upon the screen. Total darkness or a reflection on the picture screen may cause eyestrain. Soft and indirect lighting is recommended for comfortable viewing.

Preparing the remote control

Installing batteries

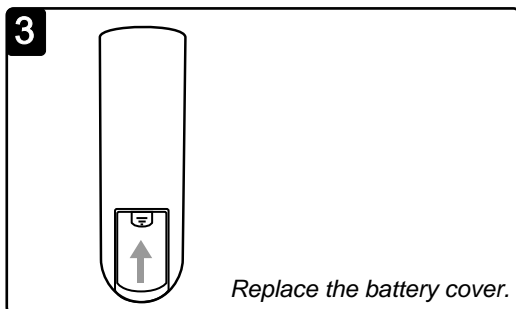
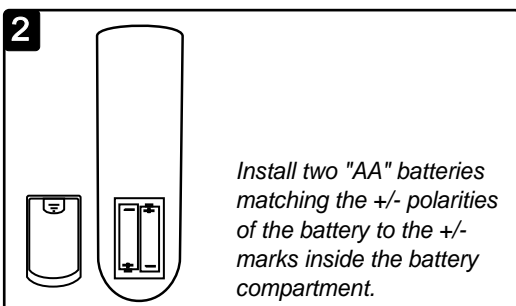
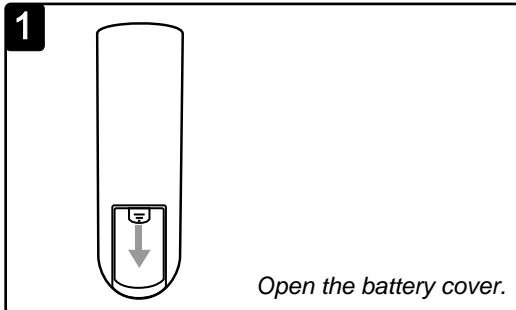

! Notes:

- Do not try to recharge batteries that are not intended to be recharged.
- Use only the size and type of batteries specified. Do not mix different types of batteries together or old batteries with fresh ones.
- When the remote control will not be used for a long period of time or when the batteries are worn out, remove the batteries.
- Do not throw the batteries into a fire. Dispose of used batteries in the specified manner.
- Do not drop, dampen or disassemble the remote control.

Effective range of the Remote

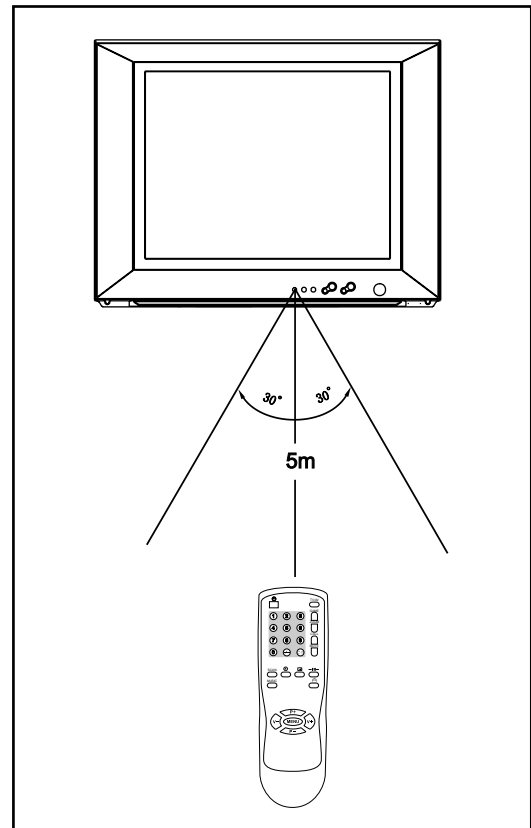

! Notes:

- When there is an obstacle between the TV and the transmitter, the transmitter may not operate.
- When direct sunlight, and incandescent lamp, fluorescent lamp or any other strong light shines on the REMOTE SENSOR of the TV the remote operation may be unstable.

External equipment connections

To connect DVD input terminals

The figure below shows how to connect the DVD input terminals of the TV set to the DVD Player, Laser Disk Player, etc.

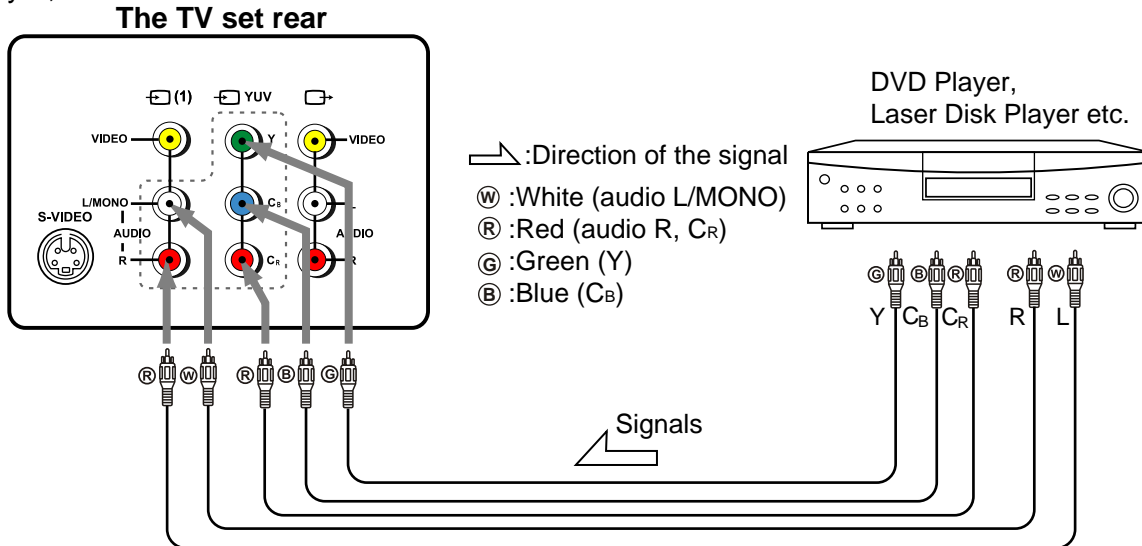

To access the unit connected to these jacks, press **TV/AV** button until **YUV** appears on the screen.

Notes:

- Both the CR terminal and the audio R terminal are red for easy identification. Make sure they are correctly connected.
- DVD and AV1 use the same group of audio input terminals.

To connect the AV Outputs

You can connect an audio system to the AV output jacks on the TV set rear to enjoy a high-quality sound from the audio system, or you can connect the AV output jacks to the VTR to record the program you like.

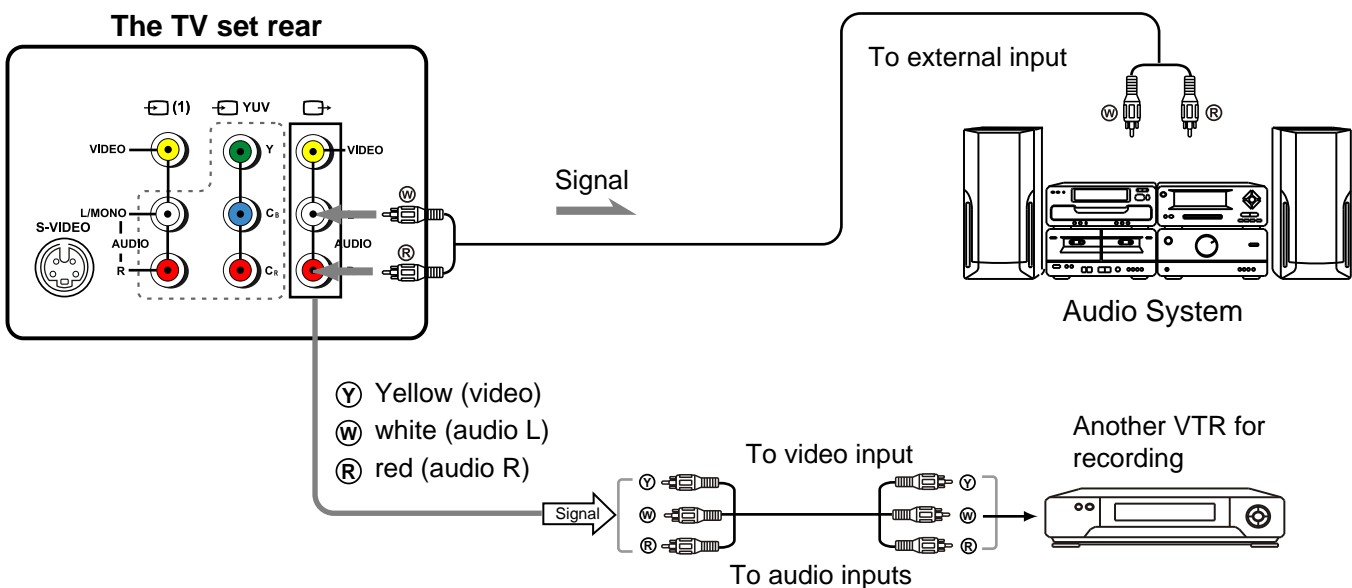

Power on/off

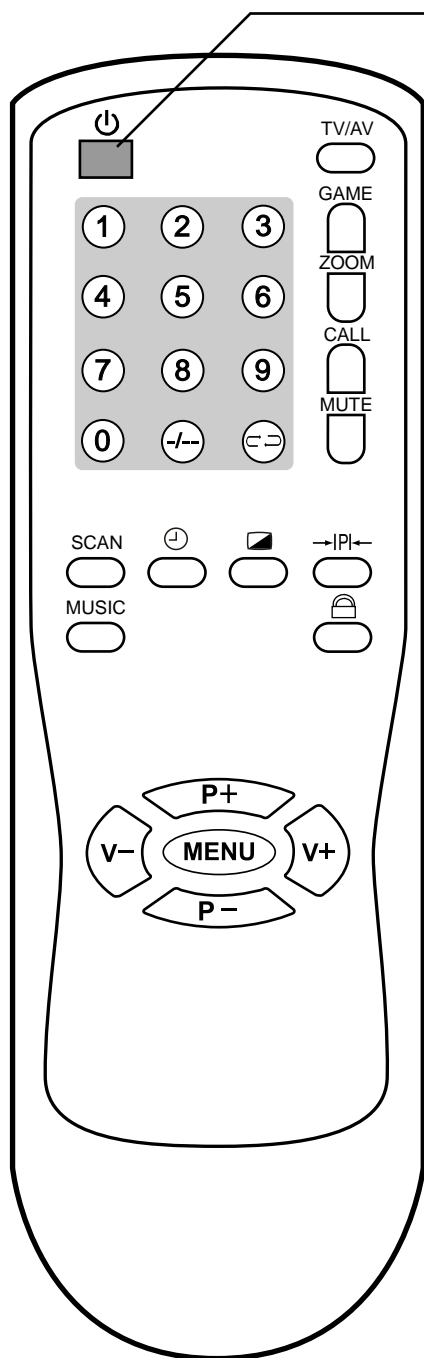

Turning on

1 Press the Power Switch on the TV set.

If no picture appears on the screen and the standby indicator lights up, the TV set is in STANDBY mode. Now please follow step 2.

2 In STANDBY mode, press standby () button on the remote controller and the TV set is turned on.

In STANDBY mode, you can also press Channel up/down button on the set to turn on the set.

Turning off

1 Press the Power Switch on the TV set if you want to cut off the power completely.

2 If you want to turn off the TV set temporarily, press the button.

Special indication:

Auto-Power-Off function: there are three kinds of Auto-Power-Off function:

1. If a vacant channel is tuned or TV broadcast for a day is finished, the TV will automatically turn off after a period of time.
2. Sleep-timer function
3. OFF timer function.

Selecting input signal

Watching AV program

This TV set provides AV input terminals for your convenient connection to VCR, DVD or other video equipment.

- 1 To watch video program from AV inputs, press **TV/AV** button repeatedly until you see the appropriate input indicator on the screen.

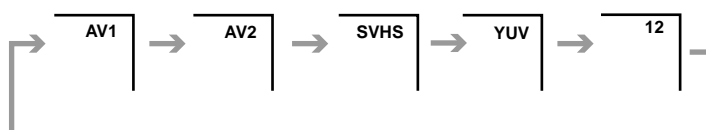

NOTE:

AV1: Select AV1 when viewing the signals from the video equipment connected to the AV 1 IN terminals.

AV2: Select AV2 when viewing the signals from the video equipment connected to the AV 2 IN terminals.

SVHS: Select SVHS when viewing the signals from the video equipment connected to the S-VIDEO IN terminals.

YUV: Select YUV when viewing the signals from the video equipment connected to the YUV IN terminals.

Switching from AV to TV

When the TV set is in AV mode, you can do the following to switch back to TV mode.

Press TV/AV button repeatedly until the TV program appears.

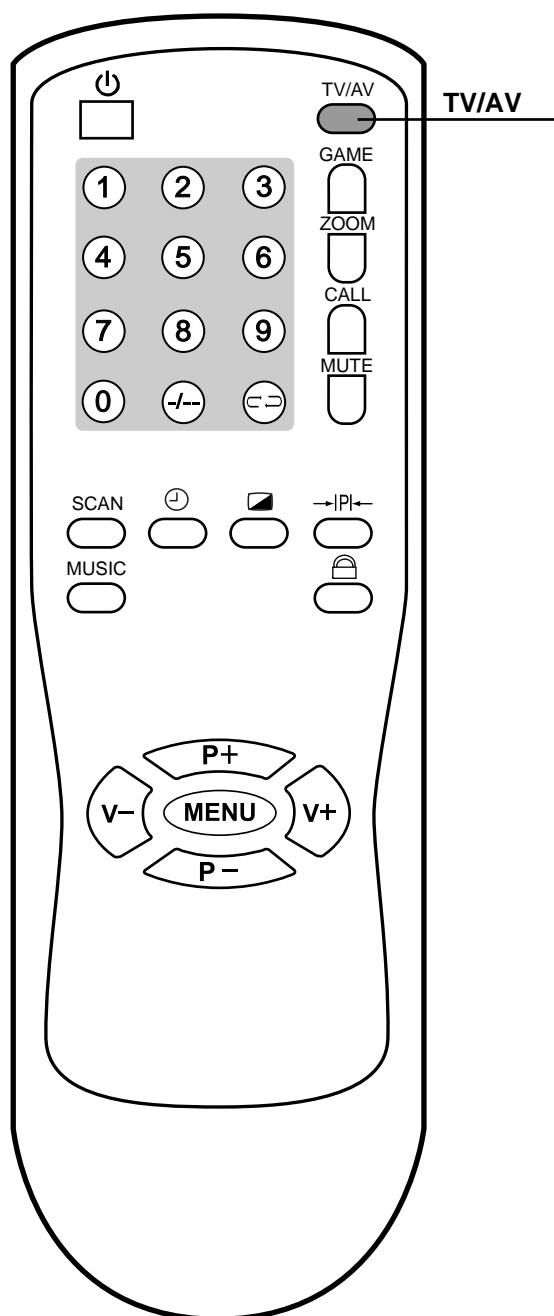

Tuning in

There are two ways to preset channels: to preset channels automatically and to preset channels manually. Below we will describe how to preset the channels by making use of the menu.

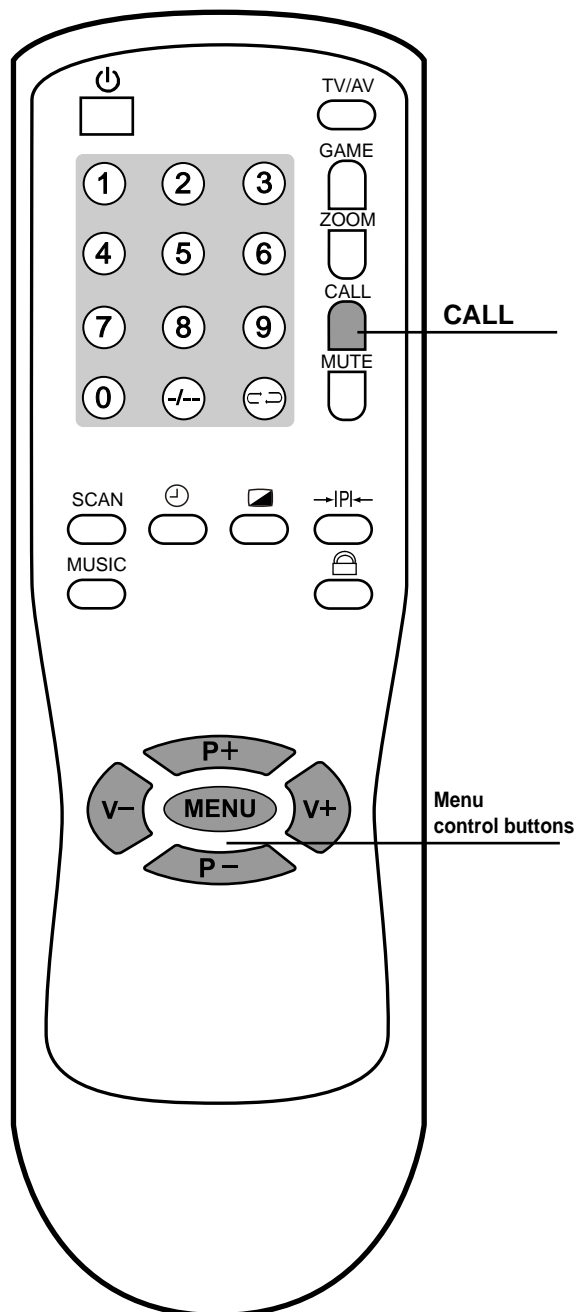

* To exit the menu, press **CALL** button or repeatedly press **MENU** button.

Auto Search

Use the Auto Search function to preset all the active channels in your local area automatically.

- 1 Press **MENU** repeatedly to display **Preset** menu.
Note: if **LOCK** is set to **ON** in **LOCK** menu, the **Preset** menu can not be entered. How to setup or change lock, please refer to page 22 for details.
- 2 Press **P+** or **P-** to select **AUTO STORE**. Press **V+** to enter into the sub-menu.
- 3 Press **P+** or **P-** to select **PROGRAM**. Press **V+** or **V-** to select an initial channel number from which you want to store (for example, program 1).
- 4 Press **P-** to select **COLOR SYSTEM** menu item, press **V+** or **V-** to select a proper colour system (normally please select **AUTO**).
- 5 Press **P-** to select **SOUND SYSTEM** menu item, press **V+** or **V-** to select your local area's sound system.
- 6 Press **P-** to select **START** menu item, press **V+** to start auto search.

| Preset | |
|-------------------|----|
| PROGRAM | 1 |
| AUTO STORE | ▶ |
| SEARCH | ▶ |
| FINE TUNING | ▶ |
| PROG EDIT | ▶ |
| SKIP | ON |



| Preset | |
|----------------|------|
| * AUTO STORE * | |
| PROGRAM | 1 |
| COLOR SYSTEM | AUTO |
| SOUND SYSTEM | B/G |
| START | ▶ |



| | |
|------------|----|
| AUTO STORE | |
| PROGRAM | 13 |
| VHF-L | 49 |
| ◀ ▶ | |

All active channels will be preset and stored into the memory automatically.
After auto search, the set will return to the initial channel.
During the process of **Auto Search**, pressing **MENU** will stop the process.

Note:
Since this model's colour system and sound system have been preset properly in factory, therefore there is no need to set the colour/sound system before auto search, the above steps 4 and 5 may be skipped.

Tuning in

If Auto Search can not preset the desired channels, or you want to preset the desired channels one by one with the preferred channel numbers, please make use of SEARCH.

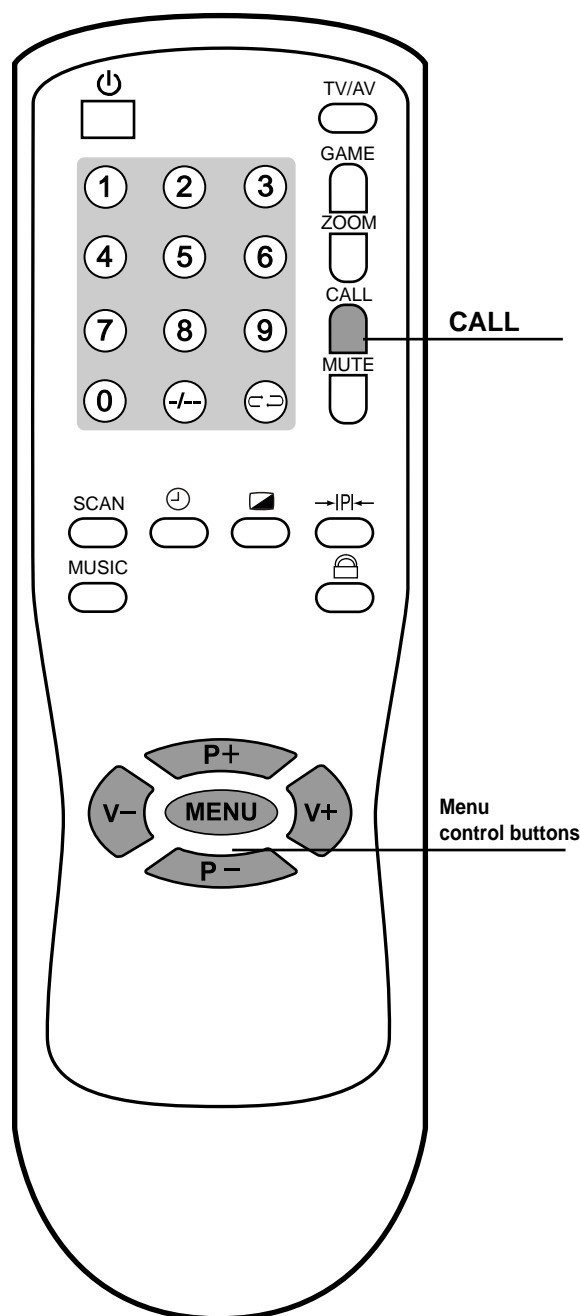

* To exit the menu, press **CALL** button or repeatedly press **MENU** button.

Notes:

1. In manual search, you can also use Band selection to quicken searching process if you know which band your desired program locates in. The band switches among VHF-L, VHF-H and UHF.
2. Repeat the above steps if you want to store another program in other program number.
3. In some model there is only with one sound system, in this case there is no need to set sound system.

Manual Search

- 1 Press **MENU** repeatedly to display **Preset** menu.
- 2 Press **P+** or **P-** to select **SEARCH**, press **V+** to enter into the sub-menu.
- 3 In **SEARCH** sub-menu, press **P+** or **P-** to select **PROGRAM**. Press **V+** or **V-** to select a channel number at which you want to store (for example, program 6).
- 4 In **SEARCH** sub-menu, press **P-** to select **SEARCH** menu item, press **V+** or **V-** to perform searching.
Press and hold **V-** to search towards lower frequency.
Press and hold **V+** to search towards higher frequency.

| Preset | |
|---------------|----|
| PROGRAM | 4 |
| AUTO STORE | ▶ |
| SEARCH | ▶ |
| FINE TUNING | ▶ |
| PROG EDIT | ▶ |
| SKIP | ON |



| Preset | |
|---------------|-------|
| * SEARCH * | |
| PROGRAM | 6 |
| COLOR SYSTEM | AUTO |
| SOUND SYSTEM | B/G |
| BAND | VHF-L |
| SEARCH | ▶ |



| | |
|---|----|
| SEARCH | |
| PROGRAM | 6 |
| VHF-L | 36 |
| <div style="display: flex; align-items: center;"> [-] [+] </div> | |

When a channel is located, the searching stops, this channel is then memorised with the preset program number.

- 5 If the searched channel is abnormal in colour, maybe the colour system setting is wrong, you may try to change the colour system. In **SEARCH** sub-menu, press **P-** to select **COLOR SYSTEM** menu item, press **V+** or **V-** to select a proper colour system.
- 6 If the searched channel is abnormal in sound, maybe the sound system setting is wrong you may try to change the sound system. In **SEARCH** sub-menu press **P-** to select **SOUND SYSTEM** menu item, press **V+** or **V-** to select a proper sound system.

| Preset | |
|---------------------|-------------|
| * SEARCH * | |
| PROGRAM | 6 |
| COLOR SYSTEM | AUTO |
| SOUND SYSTEM | B/G |
| BAND | VHF-L |
| SEARCH | ▶ |

| Preset | |
|---------------------|------------|
| * SEARCH * | |
| PROGRAM | 6 |
| COLOR SYSTEM | AUTO |
| SOUND SYSTEM | B/G |
| BAND | VHF-L |
| SEARCH | ▶ |

Tuning in

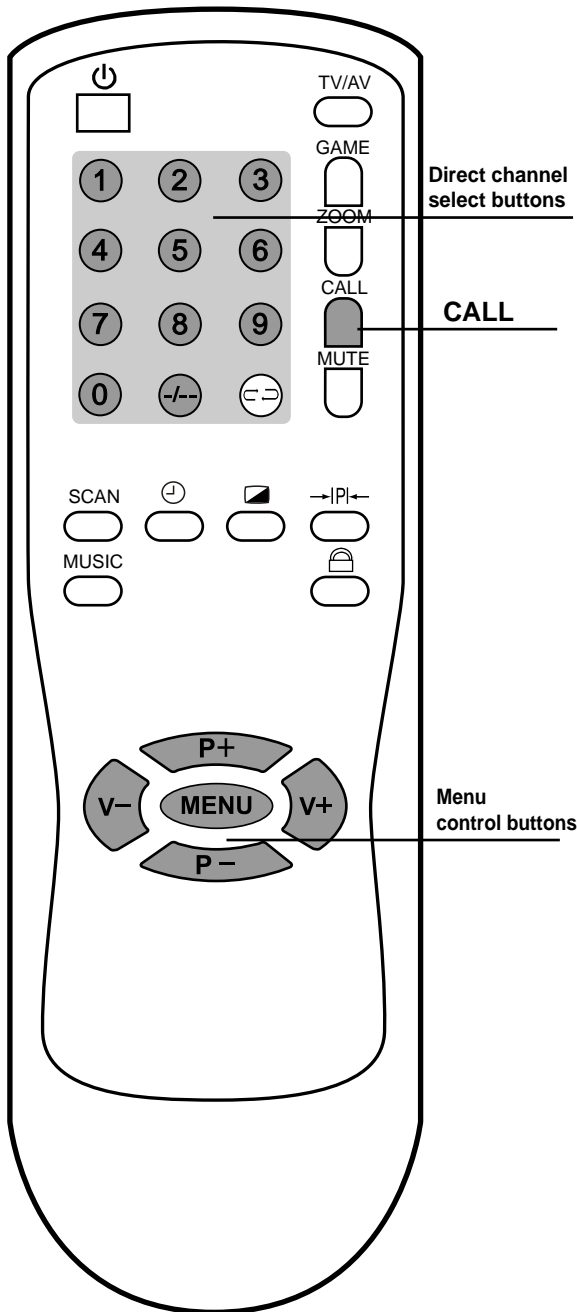

* To exit the menu, press **CALL** button or repeatedly press **MENU** button.

To skip unnecessary channel

After presetting the channels, you can skip unnecessary channels so that only the channels you want to watch are selected with Program up/down buttons.

1 Select the unwanted channel with digit buttons.

Or enter into **Preset** menu, press **P-** or **P+** to select **PROGRAM**, press **V-** or **V+** to select the unwanted channel.

| Preset | |
|-------------|-----------|
| PROGRAM | 4 |
| AUTO STORE | ▶ |
| SEARCH | ▶ |
| FINE TUNING | ▶ |
| PROG EDIT | ▶ |
| SKIP | ON |

2 Press **P-** or **P+** to select **SKIP**, press **V-** or **V+** to select **SKIP ON**.

Thus, after exiting the menu, the channel will then be skipped when you select programs with the Program up/down button.

If you want to skip other unwanted channels, repeat the above steps.

Note: you can select the skipped channel by pressing the direct channel select buttons.

To restore a skipped channel

Enter into **Preset** menu, select the program number you want to restore. Press **P-** or **P+** to select **SKIP**, press **V-** or **V+** to select **SKIP OFF**.

Manual Fine Tuning

Fine tuning is not necessary under normal conditions. However, in area of inferior broadcast conditions where adjustment is necessary for a better picture and sound, use Fine tuning.

1 Select the channel you want to fine-tune.

2 Enter into **Preset** menu, press **P-** or **P+** to select **FINE TUNING**, then press **V+** to enter into the sub-menu.

| Preset | |
|--------------------|----|
| PROGRAM | 1 |
| AUTO STORE | ▶ |
| SEARCH | ▶ |
| FINE TUNING | ▶ |
| PROG EDIT | ▶ |
| SKIP | ON |



3 In **FINE TUNING** sub-menu, press **P-** or **P+** to select **TUNING**, then press and hold **V+** or **V-** to fine tune to obtain best possible picture and sound.

| Preset | |
|-----------------|------|
| * FINE TUNING * | |
| PROGRAM | 2 |
| COLOR SYSTEM | AUTO |
| SOUND SYSTEM | B/G |
| TUNING | ▶ |

Channel selection

You can select your desired TV program by one of the following methods.

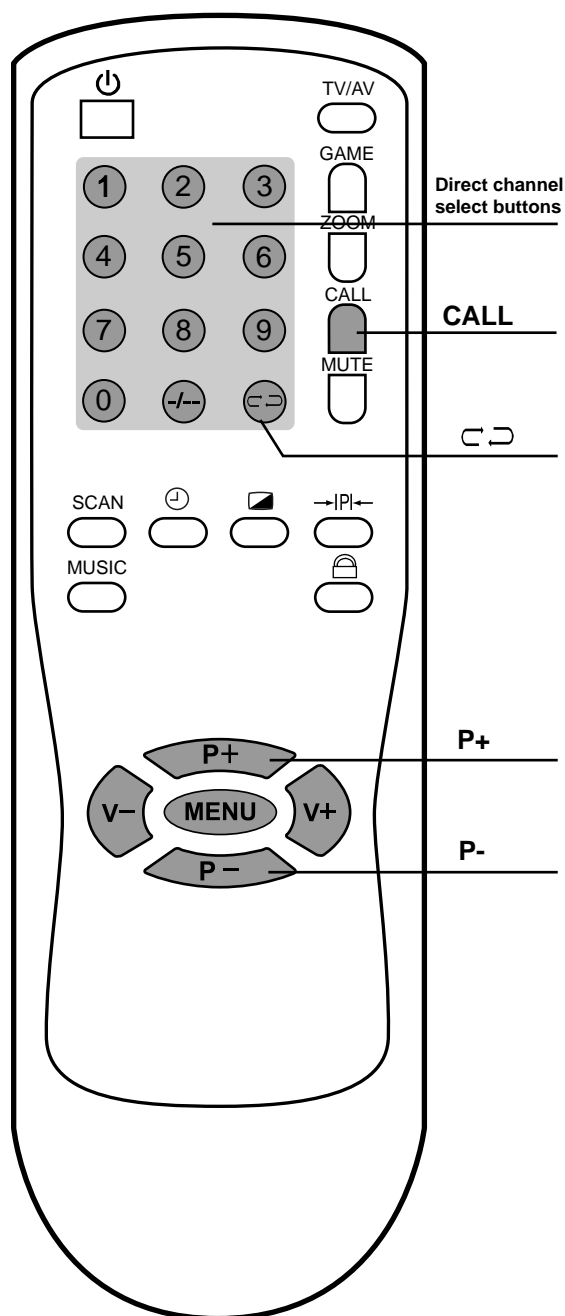

Use Direct Channel Select buttons

To select one-digit channel:

Press 0-9 button directly.

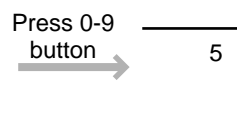

To select two-digit channel:

Press -/-- button to display "--" then input the number.

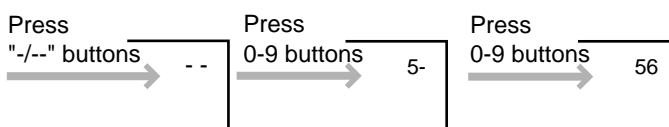

To select three-digit channel:

Press -/-- button to display "1--", then input the number.



* In this model the maximum channel number is 199.

Use Program up/down buttons

Press **P+** button, the channel number increases;
Press **P-** button, the channel number decreases.

Use Previous program button

Press **↵** button to switch between the current program and the previous one.

Notes:

Use CALL button to know the current channel number.

Press **CALL** button to display the current TV state. If in TV program viewing, then it will display the current channel number, colour system, sound system and audio mode. If you have set sleep timer, the remaining time will also be displayed.

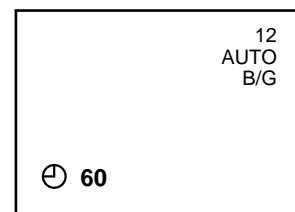

Channel edit

You can edit the channel programs in your favourite order.

Channel edit

- 1** Press **MENU** repeatedly to display *Preset* menu.
- 2** Press **P+** or **P-** to select **PROG EDIT**.
- 3** Press **V+** to enter into **EDIT PROG** sub-menu.
- 4** Select **PROGRAM** item. Press **V+** or **V-** to select a program number which you want to swap.
- 5** Select **TO** item, press **V+** or **V-** to select a program number which you want to swap to.
- 6** Highlight **SWAP** and press **V+** to confirm. Now these two programs' contents are swapped.

| <i>Preset</i> | |
|------------------|----|
| PROGRAM | 4 |
| AUTO STORE | ▶ |
| SEARCH | ▶ |
| FINE TUNING | ▶ |
| PROG EDIT | ▶ |
| SKIP | ON |



| <i>Preset</i> | |
|---------------|----|
| * EDIT PROG * | |
| PROGRAM | 4 |
| TO | 10 |
| SWAP | |

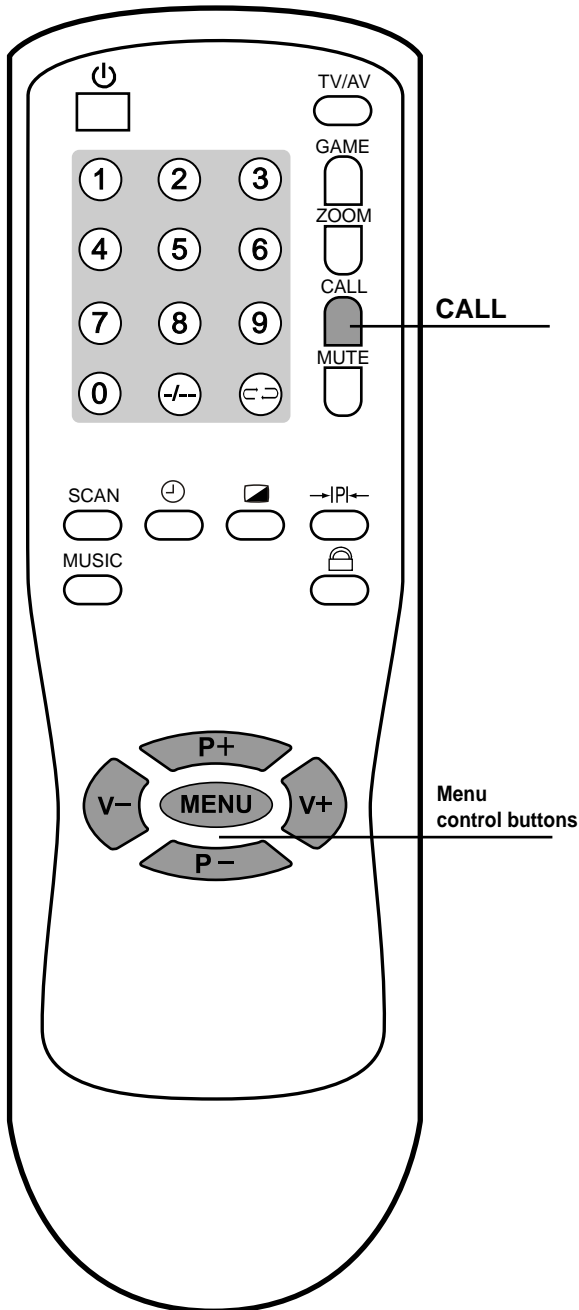

* To exit the menu, press **CALL** button or repeatedly press **MENU** button.

Repeat the above steps to edit the programs in your favourite order.

Picture adjustment

To select the picture mode

You can select the picture quality instantly among three preset modes and one user-set mode.

Press $\rightarrow|P|\leftarrow$ button to select the desired picture quality. **MILD**, **DYNAMIC**, **STANDARD** and **USER** (user-set) can be selected cyclically.

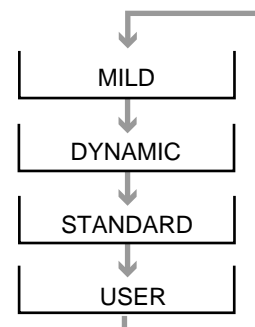

| Mode | Picture quality |
|----------|-----------------------------|
| MILD | Display soft pictures |
| DYNAMIC | Display dynamic pictures |
| STANDARD | Display normal pictures |
| USER | The picture quality you set |

Picture adjustment

- 1 Press **MENU** button to display the **Picture** menu.
- 2 Press **P+** or **P-** to select item.
- 3 Press **V+** or **V-** to adjust the level.

| Picture | |
|------------|--------|
| BRIGHT | 14 |
| CONTRAST | 25 |
| COLOR | 50 |
| SHARPNESS | 41 |
| TINT | 0 |
| WHITE TONE | NORMAL |

You can also press \blacksquare button to call up the **Picture** menu.

| Item | V- | V+ |
|------------|------------------|----------|
| BRIGHT | darker | lighter |
| CONTRAST | weaker | stronger |
| COLOR | paler | deeper |
| SHARPNESS | softer | sharper |
| *TINT | purplish | greenish |
| WHITE TONE | NORMAL/COOL/WARM | |

Notes:

Tint is only for NTSC system.

The adjustment level is stored in the **USER** position.

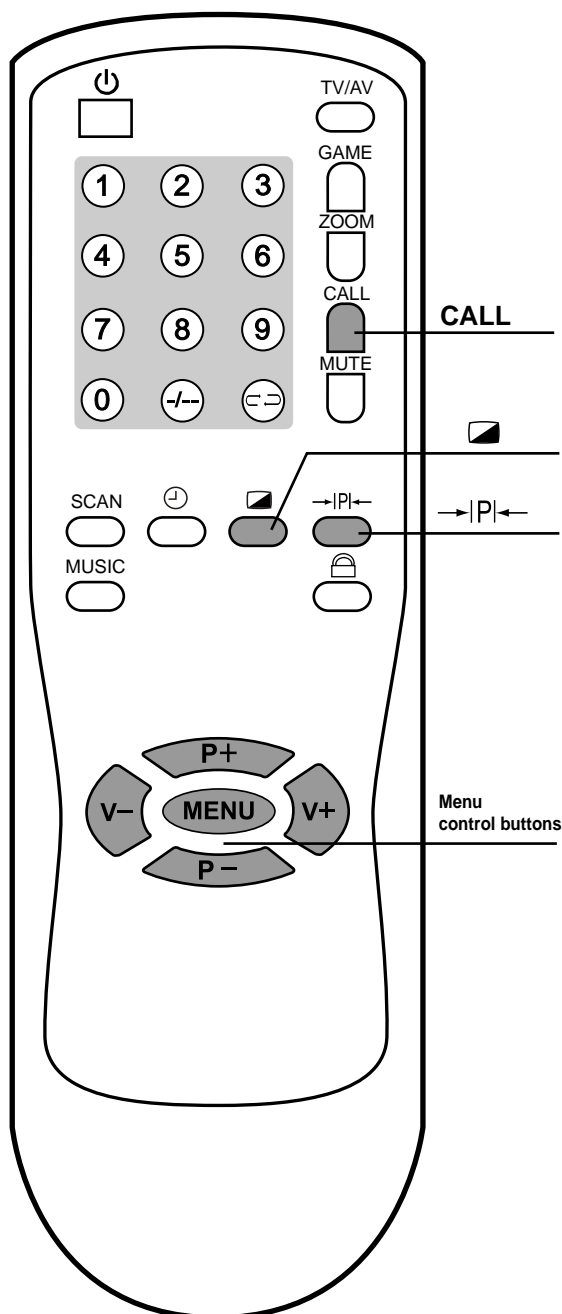

* To exit the menu, press **CALL** button or repeatedly press **MENU** button.

Sound controls

Adjusting volume

1 Use Volume up/down button

Press **V-** button, the volume decreases;
Press **V+** button, the volume increases.

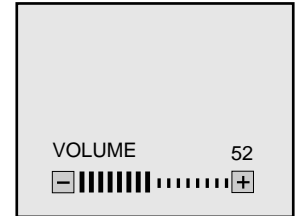

2 Use MUTE button

If you want to mute the sound, press **MUTE** button on the remote.

To resume the sound, press this button again.

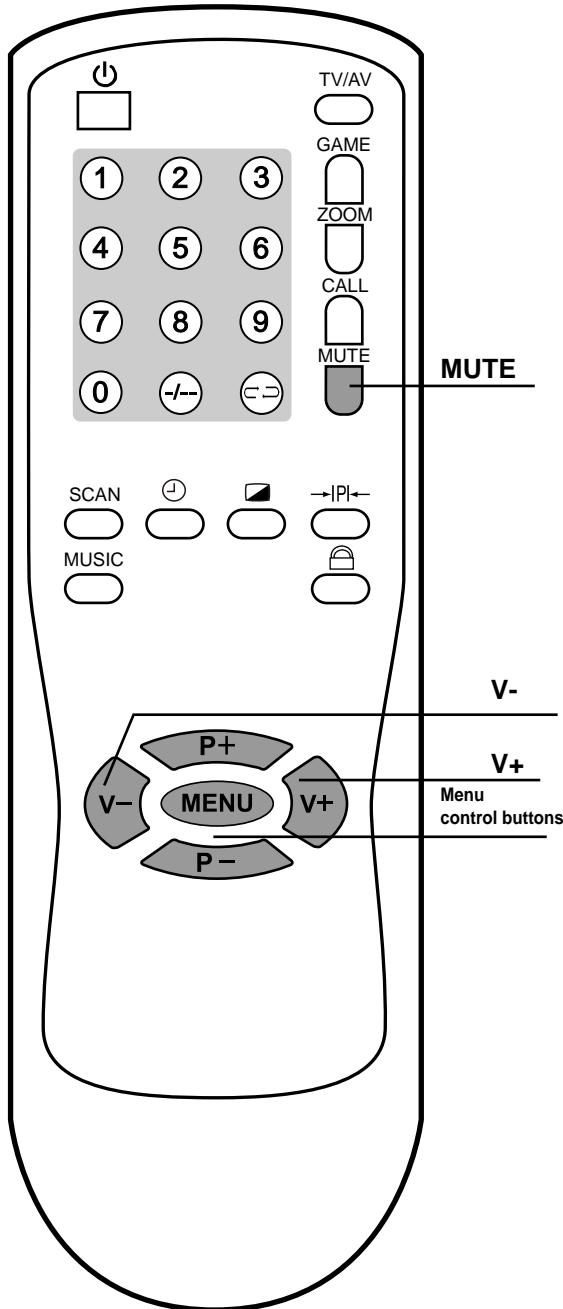

Making use of Sound menu

1 Press MENU repeatedly to display Sound menu.

2 Press P+ or P- to select desired adjusting item.

3 Press V+/- to adjust the level.

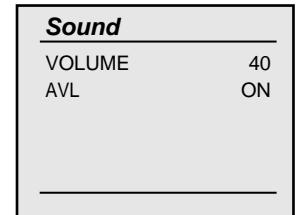

| Item | V- | V+ |
|--------|--------|----------|
| Volume | weaker | stronger |
| *AVL | ON/OFF | |

* **AVL**: auto volume limit.

Each broadcasting station has its own signal conditions, which can make it necessary to adjust the volume every time the channel is changed. **Turning "AVL" On lets' you automatically adjust the volume of the desired channel** by lowering the sound output when the modulation signal is high or by raising the sound output when the modulation signal is low.

Timer setting

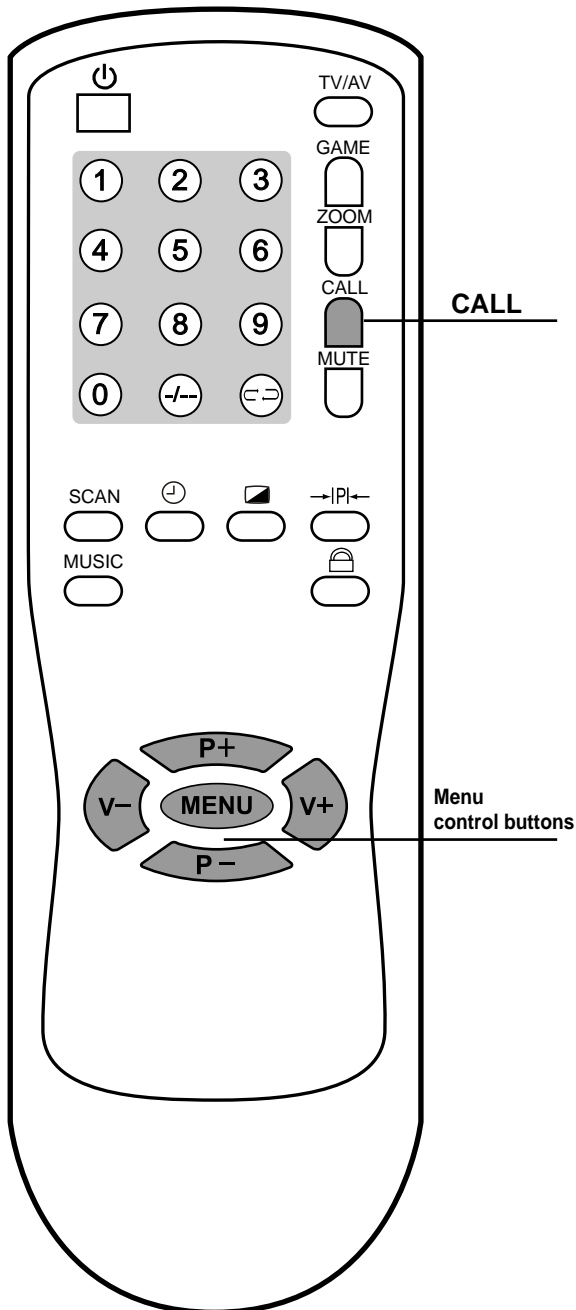

Setting clock time

Making use of this function can set the current time for the TV.

- 1 Press **MENU** repeatedly to display the **Time** menu.
- 2 Press **P-** or **P+** to select **CLOCK**.
- 3 Press **V-** to set the hour (0-23), press **V+** to set the minute (00-59).

| Time | |
|--------------|-------|
| CLOCK | 12:00 |
| OFF TIME | --:-- |
| ON TIME | --:-- |
| PROGRAM | 0 |

Note:

Before setting the OFF timer and ON timer, please set the CLOCK item first.

Setting OFF timer

With the OFF timer, the TV will automatically switch to standby mode at a preset time.

- 1 In **Time** menu, press **P-** or **P+** to select **OFF TIME**.
- 2 Press **V-** to set the hour (0-23), press **V+** to set the minute (00-59).

| Time | |
|-----------------|-------|
| CLOCK | 12:05 |
| OFF TIME | 13:50 |
| ON TIME | --:-- |
| PROGRAM | 0 |

Once the preset time has elapsed, the TV will automatically go into standby mode.

* To exit the menu, press **CALL** button or repeatedly press **MENU** button.

Timer setting

Setting ON timer/ON program

With the ON timer, the TV will automatically turn on to a preset channel at a preset time.

1 In **Time** menu, press **P-** or **P+** to select **ON TIME**.

Press **V-** to set the hour (0-23), press **V+** to set the minute (00-59).

| Time | |
|----------------|--------------|
| CLOCK | 12:09 |
| OFF TIME | 13:50 |
| ON TIME | 18:10 |
| PROGRAM | 4 |

2 Press **P-** to select **PROGRAM**.

Press **V-** or **V+** to set the TV ON program number.

| Time | |
|----------------|----------|
| CLOCK | 12:09 |
| OFF TIME | 13:50 |
| ON TIME | 18:10 |
| PROGRAM | 4 |

3 Press **⏻** button to switch the TV to standby mode.

At the preset time, the TV will turn on automatically to the preset channel.

Setting sleep timer

Making use of the Sleep timer function allows you to have the set automatically turn off after a preset time, and bring the TV to standby mode.

With every press of **⌚** button the sleep time changes in the sequence of 0 → 15 → 30 → 45 → 60 → 75 → 90 → 150 → 120 → 135 → 150 → 165 → 180 → 195 → 210 → 225 → 240 → 0 (minutes) ----.

For example, if you would like the TV to auto turn off in 60 minutes, you can press **⌚** button repeatedly until the screen displays the desired amount of time. If you want to cancel the sleep timer, you can press **⌚** button repeatedly until **0** displays on the screen.

⌚ 60

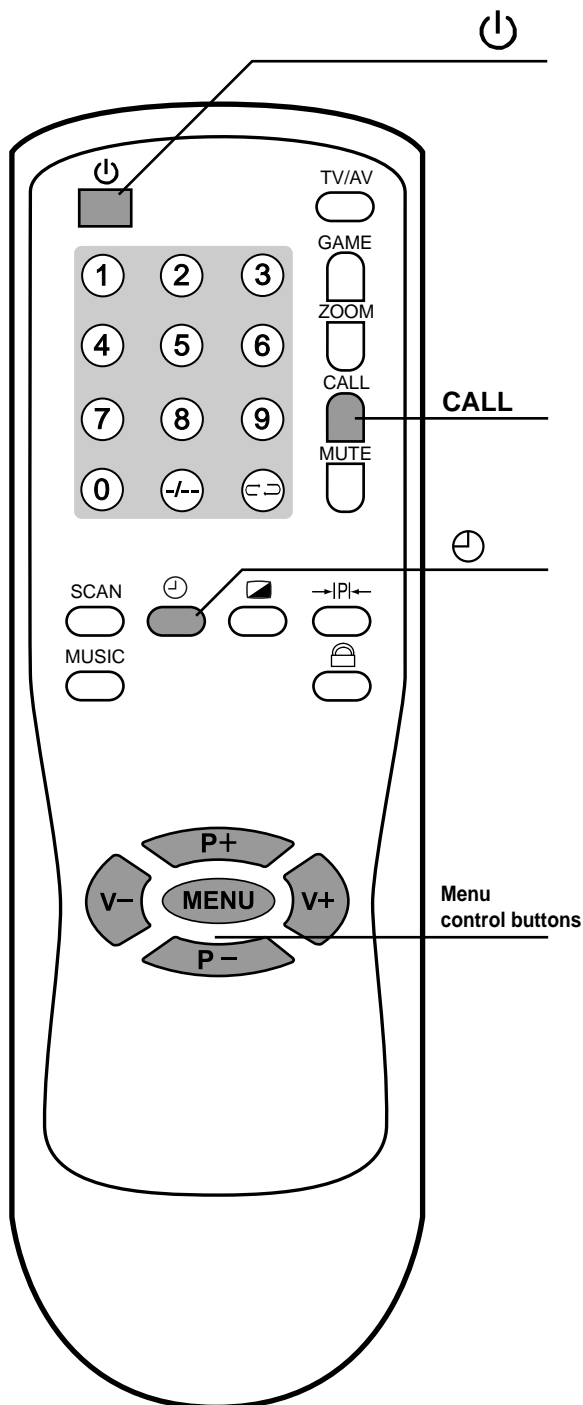

* To exit the menu, press **CALL** button or repeatedly press **MENU** button.

System setup

Setting Blue Screen

- 1 Press **MENU** repeatedly to display **Setup** menu.
- 2 Press **P-** or **P+** to select **BLUE SCREEN**.
- 3 Press **V+** or **V-** to turn on/off **BLUE SCREEN**.
If the **BLUE SCREEN** is turned on, the TV will appear a blue screen when there is no input signal.

Setup

| | |
|--------------------|-----------|
| BLUE SCREEN | ON |
| PICTURE ENHANCE | ON |
| CALENDAR | ▶ |

Setting Picture Enhance

- 1 Enter into **Setup** menu.
- 2 Press **P-** or **P+** to select **PICTURE ENHANCE**.
- 3 Press **V+** or **V-** to turn on/off **Picture Enhance**.
Turning on **PICTURE ENHANCE** can improve the picture quality.

Setup

| | |
|------------------------|-----------|
| BLUE SCREEN | ON |
| PICTURE ENHANCE | ON |
| CALENDAR | ▶ |

Calendar function

- 1 Enter into **Setup** menu.
- 2 Press **P-** or **P+** to select **CALENDAR**.
- 3 Press **V+** to enter into the calendar interface.
- 4 Pressing **P+** or **P-** can check years' calendar forward or backward.
Pressing **V+** or **V-** can check months' calendar of some year forward or backward.

Setup

| | |
|-----------------|----|
| BLUE SCREEN | ON |
| PICTURE ENHANCE | ON |
| CALENDAR | ▶ |



2004 FEB

| SU | MO | TU | WE | TH | FR | SA |
|----|----|----|----|----|----|----|
| 1 | 2 | 3 | 4 | 5 | 6 | 7 |
| 8 | 9 | 10 | 11 | 12 | 13 | 14 |
| 15 | 16 | 17 | 18 | 19 | 20 | 21 |
| 22 | 23 | 24 | 25 | 26 | 27 | 28 |
| 29 | | | | | | |

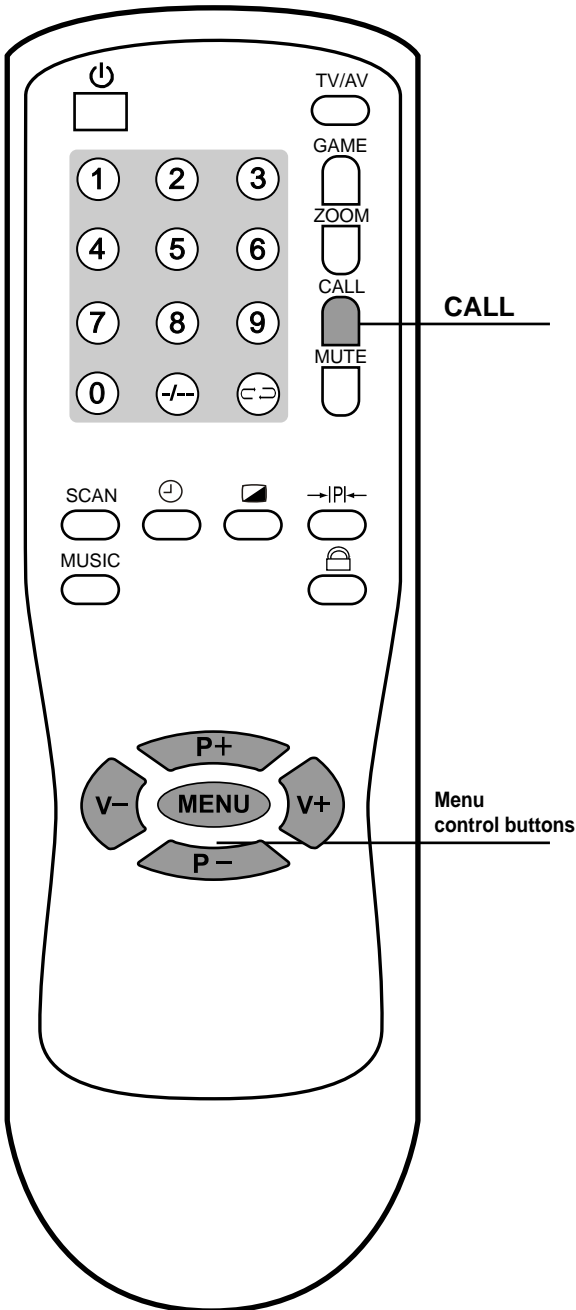

* To exit the menu, press **CALL** button or repeatedly press **MENU** button.

Lock setting

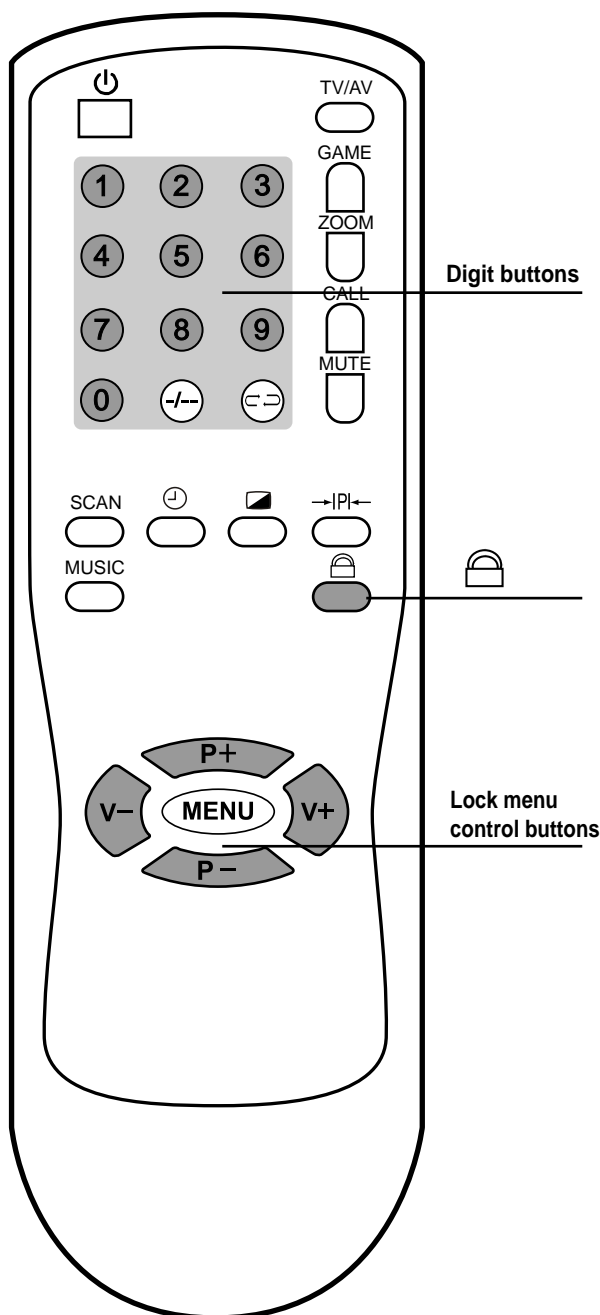

The master password to enter into **LOCK** menu is 4100. Make sure not let children know the password.

The Child Lock function blocks the viewing of any channel for which the child lock has been set.

To use the Child Lock function, you first need to set your password.

To set a password

- 1 To enter into **LOCK** menu, press button. Now a password is required to input.
- 2 Press digit buttons to input the password (four-digit, the default password is 0000 and you should change it) to enter into **Lock** menu.
- 3 Press **P-** to select **CHANGE PIN** item. Press **V+** button to enter into the sub-menu.
- 4 Enter a new password and confirm again. Now the password has been modified successfully.

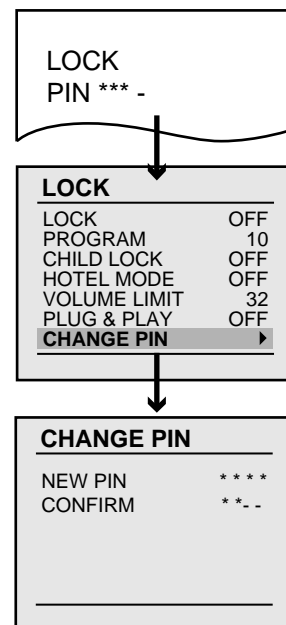

TV program child lock setup

- 1 Enter into **LOCK** menu. Highlight **PROGRAM** and use **V+** or **V-** to select a program you want to lock.
- 2 Press **P-** or **P+** button to select **CHILD LOCK** item. Press **V+** or **V-** button to set **On**.
- 3 Repeat the above steps to set child lock to other TV program.
- 4 Press **P+** button to select **LOCK** item. Press **V+** or **V-** button to set **ON**.
- 5 Press button to exit the menu.

| LOCK | |
|-------------------|-----------|
| LOCK | OFF |
| PROGRAM | 10 |
| CHILD LOCK | ON |
| HOTEL MODE | OFF |
| VOLUME LIMIT | 32 |
| PLUG & PLAY | OFF |
| CHANGE PIN | ▶ |

| LOCK | |
|--------------|-----------|
| LOCK | ON |
| PROGRAM | 10 |
| CHILD LOCK | ON |
| HOTEL MODE | OFF |
| VOLUME LIMIT | 32 |
| PLUG & PLAY | OFF |
| CHANGE PIN | ▶ |

Now the Child Lock function is activated, the locked channel's screen is blank and a locked icon appears on the screen.

Important note: to enable child lock, you must both set **Lock** to **On** and **Child Lock** to **On** in **Lock** menu.

To cancel child lock function, press button and then input password to enter into **LOCK** menu, select **LOCK** item and set it to **Off** (it is a general lock).

Note: if **LOCK** is set to **On**, the **PRESET** menu can not be entered.

Lock setting

This unit provides Hotel Lock function, you can limit sound volume which is especially useful in hotel.

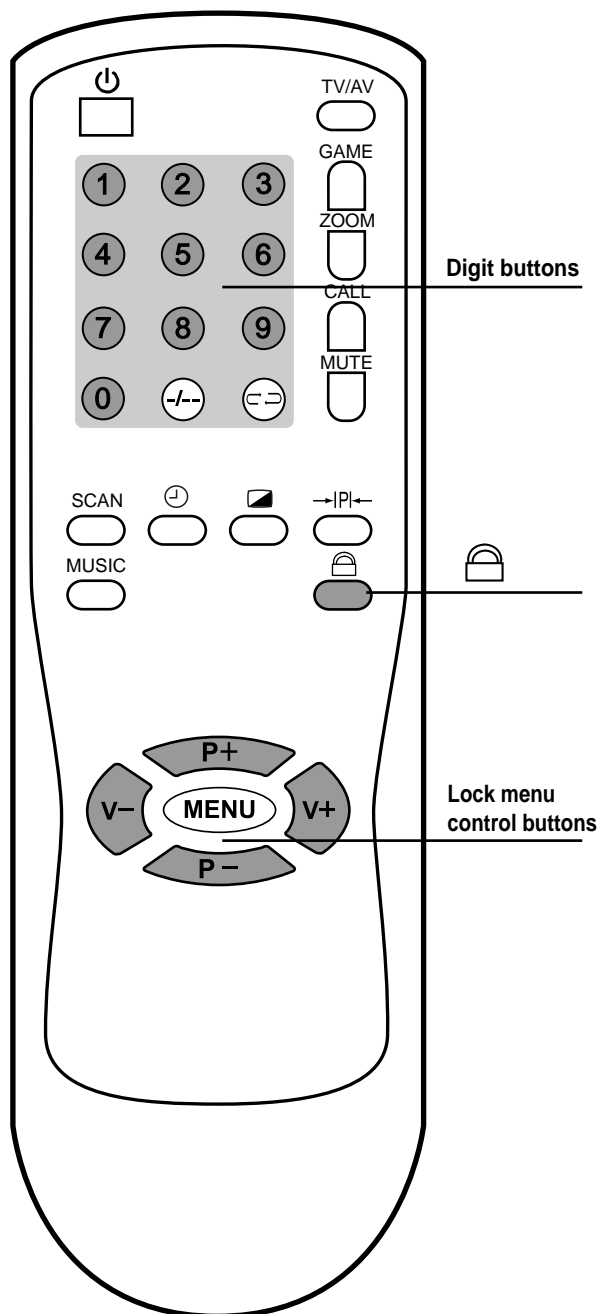

Hotel lock setup

- 1 Use password to enter into **LOCK** menu.
- 2 Select **LOCK** item and press **V+** or **V-** button to set **ON**.
- 3 Press **P-** button to select **HOTEL MODE** item.
Press **V+** or **V-** button to set **On**.
- 4 Press **P-** button to select **VOLUME LIMIT** item.
Press **V+** or **V-** button to set a maximum volume.

LOCK

| | |
|-------------------|-----------|
| LOCK | ON |
| PROGRAM | 10 |
| CHILD LOCK | ON |
| HOTEL MODE | ON |
| VOLUME LIMIT | 32 |
| PLUG & PLAY | OFF |
| CHANGE PIN | ▶ |

LOCK

| | |
|---------------------|-----------|
| LOCK | OFF |
| PROGRAM | 10 |
| CHILD LOCK | ON |
| HOTEL MODE | ON |
| VOLUME LIMIT | 50 |
| PLUG & PLAY | OFF |
| CHANGE PIN | ▶ |

Now Hotel Lock functions, the volume is limited.

To cancel Hotel Lock, input the correct password to enter into **Lock** menu and set **LOCK** to **OFF**.

PLUG & PLAY function

When you set PLUG & PLAY to ON, next time you turn on the set by Power Switch, the set will automatically perform auto search (please make sure that the antenna connection is OK before you turn on). After auto search, the PLUG & PLAY will auto be set to OFF. Below is the steps:

- 1 Use password to enter into **LOCK** menu.
- 2 Press **P-** button to select **PLUG & PLAY** item.
Press **V+** or **V-** button to set **On**.

LOCK

| | |
|------------------------|-----------|
| LOCK | ON |
| PROGRAM | 10 |
| CHILD LOCK | ON |
| HOTEL MODE | OFF |
| VOLUME LIMIT | 32 |
| PLUG & PLAY | ON |
| CHANGE PIN | ▶ |

Note:

- If **LOCK** is set to **ON**, **PLUG & PLAY** function does not work.
- **PLUG & PLAY** function is an optional function, it is only available on certain versions and we recommend you had better not use it.

Other functions

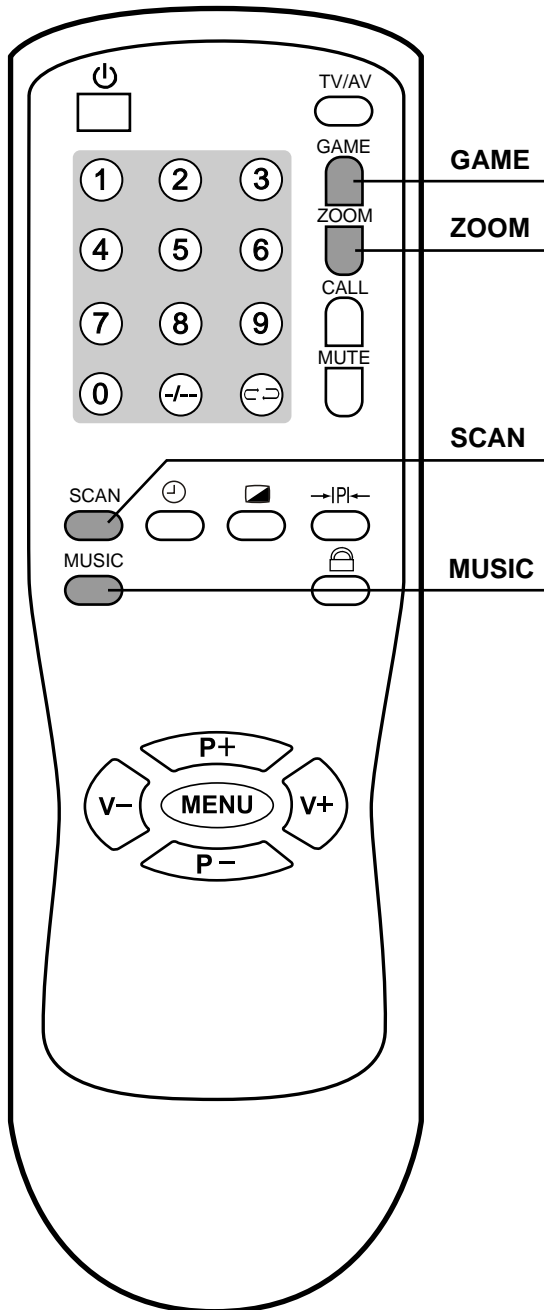

ZOOM function

Making use of zoom function can change the screen's vertical size.

Press **ZOOM** button repeatedly, **ZOOM, 16:9** and **4:3** can be selected cyclically. You can select one of them according to actual need, for example, to view wide screen movie VCD.

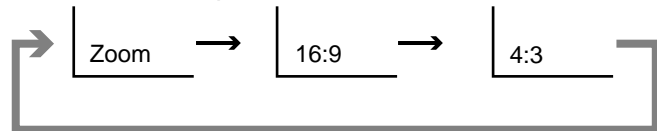

To scan programs

Press **SCAN** button, the TV set will scan the channels from current channel to higher channels one by one, every program will be displayed for about two seconds and then go on scanning.

Press **SCAN** button again to stop.

Music TV function

Press **MUSIC** button to enter into **MUSIC MODE**. In this mode, the screen is blank while the sound is normal. You can make use of this function to reduce eyestrain while the sound still can be listened. Press **MUSIC** button again to exit the mode.

MUSIC MODE

Playing game

This TV set provides a built-in game (BOXMAN) for you to play.

- 1 Press **GAME** button and **BOXMAN** game playing interface will appear.
- 2 In boxman mode, the box should be moved to specific place.
Press **P+** or **P-** to move the box upward or downward.
Press **V+** or **V-** to move the box rightward or leftward.
Press **[1]** digit button to select previous stage of game.
Press **[2]** digit button to select next stage of game.
Press **CALL** button to exit.
Press **MENU** button to restart.
- 3 The player should control the man to push the box to the destinations within the wall by using **P+/P-/V+/V-** buttons. When you push all boxes to the relevant destinations then you win the game.

Troubleshooting Guide

Before calling service personnel, please check the following chart for a possible cause to the trouble you are experiencing.

| Symptoms | Check the following items |
|---|---|
| Power is not turned on. | <ul style="list-style-type: none"> <input type="checkbox"/> Be sure the power cord is plugged in. |
| Poor colour poor tint. | <ul style="list-style-type: none"> <input type="checkbox"/> Contrast, colour tint are not correctly adjusted |
| Spots appear on the screen. | <ul style="list-style-type: none"> <input type="checkbox"/> Possible interferences of automobiles, motorcycle, trolley bus, neon lamps, etc. |
| Stripes appear on the screen. | <ul style="list-style-type: none"> <input type="checkbox"/> Possible interference of electronic interference from another TV set, a computer, an electronics game machine, a broadcast station, etc. |
| Double images or "ghosts". | <ul style="list-style-type: none"> <input type="checkbox"/> This may be caused by reflections from nearby mountains or buildings. <input type="checkbox"/> Check the antenna direction. |
| Snowy picture. | <ul style="list-style-type: none"> <input type="checkbox"/> It is possible that the aerial "lead-in" is damaged or comes off. <input type="checkbox"/> Check the antenna direction. |
| No Sound, Picture is OK. | <ul style="list-style-type: none"> <input type="checkbox"/> Check sound volume levels. <input type="checkbox"/> Make sure the TV is not muted. |
| Preset menu can not be entered. | <ul style="list-style-type: none"> <input type="checkbox"/> When LOCK is set to ON, the Preset menu can not be entered. You may use password to enter into Lock menu to set LOCK to OFF. |
| Volume is limited. | <ul style="list-style-type: none"> <input type="checkbox"/> The set is in Hotel Lock On mode. Use password to enter into Lock menu and set LOCK to OFF. |
| TV cabinet creaks. | <ul style="list-style-type: none"> <input type="checkbox"/> Even if the picture or the sound is normal, changes in the room temperature sometimes make the TV cabinet expand or contract, making a noise. This does not indicate a malfunction. |
| Remote controller does not work. | <ul style="list-style-type: none"> <input type="checkbox"/> The batteries may be worn out. <input type="checkbox"/> The batteries may be installed with their polarity reversed. |
| Unevenness in colour in some parts of the screen. | <ul style="list-style-type: none"> <input type="checkbox"/> When the set is switched on, do not shift or move the set around. Sometimes it may develop an unevenness in colour in some parts of the screen. This can be eliminated by switching off the set with the POWER switch and wait for 30 minutes before switching on again. |

Troubleshooting Guide

Reception disturbances

Most types of television interference can be remedied by adjusting the height and position of the VHF/UHF antenna. Outdoor antennas are recommended for best results if not using cable. The most common types of television interference are shown below. If one of these symptoms appear when the TV is connected to a Cable TV system, the disturbance may be caused by the local cable company broadcast.

IGNITION:

Black spots or horizontal streaks may appear, picture, may flutter or drift. Usually caused by interference from automobile ignition systems, neon lamps, electric drills and other electric appliances.



GHOSTS:

Ghosts are caused by the television signal following two paths. One is the direct path and the other is reflected from tall buildings, hills or other objects. Changing the direction or position of the antenna may improve the reception.



SNOW:

If your receiver is located in the fringe area of a television station where the signal is weak, your picture may be marred by the appearance of small dots. When the signal is extremely weak, it may be necessary to install an external antenna to improve the picture.



RADIO FREQUENCY INTERFERENCE:

This interference produces moving ripples or diagonal streaks, and in some cases, causes loss of contrast in the picture.



PICTURE SIZE VARIATION:

A slight picture size variation is quite normal when you adjust the CONTRAST or BRIGHTNESS setting.

CARE AND MAINTENANCE

To prevent fire or shock hazard, disconnect your unit from the AC power source when cleaning. The finish on the receiver may be cleaned with a dust cloth and cared for as other furniture. Use caution when cleaning and wiping the plastic parts. Mild soap and a soft, damp cloth may be used.

Specifications

Power Supply: AC 240V, 50Hz
Power Consumption: 150W (Max.)
Dimensions (mm): 760 (W) x 595 (H) x 490 (D)
Weight (kg): 43
CRT: 68cm

TV system & channel range

| System | VHF | UHF | CATV |
|---------|------|-------|---------------|
| PAL-B/G | 2-12 | 21-69 | X~Z+2, S1~S41 |

Colour System: PAL-BG, NTSC (AV)
Sound output: 4W + 4W
Accessories: Remote control x 1

Note: Design and specifications are subject to change without notice.

N.G. ENTERPRISES PTY LTD
1 JOYNTON AVENUE
WATERLOO NSW 2017 AUSTRALIA
TEL: (02) 9313 7111
FAX: (02) 9313 7555
www.palsonic.com.au

N.G. ENTERPRISES PTY LTD
TELEPHONE
AUSTRALIA: 1300 657 888

604-TK21263-00

Free Manuals Download Website

<http://myh66.com>

<http://usermanuals.us>

<http://www.somanuals.com>

<http://www.4manuals.cc>

<http://www.manual-lib.com>

<http://www.404manual.com>

<http://www.luxmanual.com>

<http://aubethermostatmanual.com>

Golf course search by state

<http://golfingnear.com>

Email search by domain

<http://emailbydomain.com>

Auto manuals search

<http://auto.somanuals.com>

TV manuals search

<http://tv.somanuals.com>