

# PRO-FORM<sup>®</sup>

# 160

Model No. PFEL8947.0

Serial No. \_\_\_\_\_

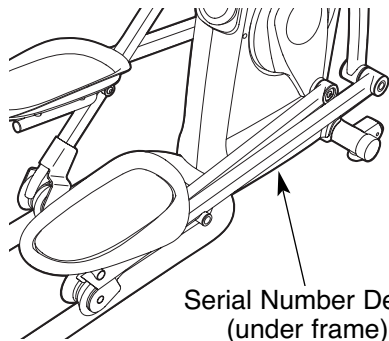

Serial Number Decal  
(under frame)

## USER'S MANUAL

### QUESTIONS?

As a manufacturer, we are committed to providing complete customer satisfaction. If you have questions, or if parts are damaged or missing, PLEASE CONTACT OUR CUSTOMER SERVICE DEPARTMENT DIRECTLY.

CALL TOLL-FREE:

**1-888-533-1333**

Mon.-Fri., 6 a.m.-6 p.m. MST

ON THE WEB:

[www.proformservice.com](http://www.proformservice.com)

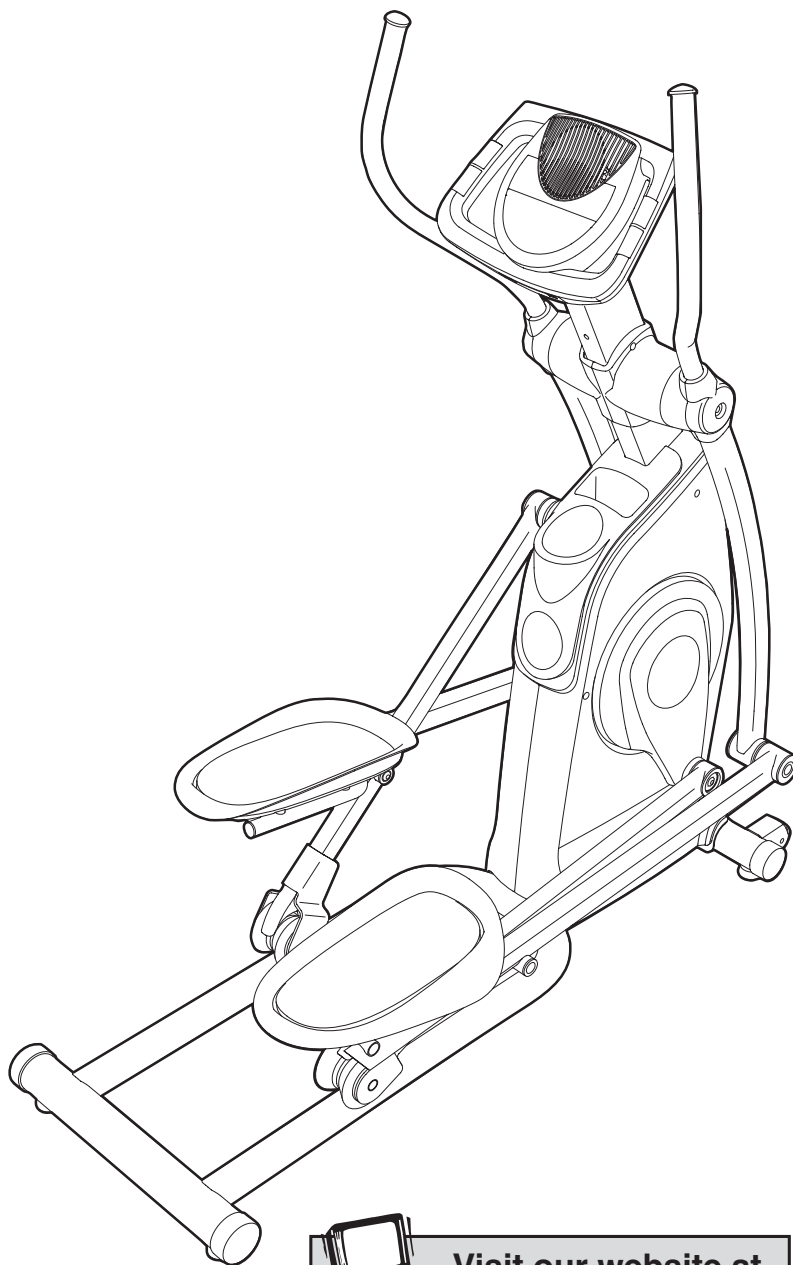

### ⚠ CAUTION

Read all precautions and instructions in this manual before using this equipment. Keep this manual for future reference.



Visit our website at

[www.proform.com](http://www.proform.com)

new products, prizes,  
fitness tips, and much more!

# PRO-FORM<sup>®</sup> 160

---

## TABLE OF CONTENTS

IMPORTANT PRECAUTIONS .....	.3
BEFORE YOU BEGIN .....	.4
ASSEMBLY .....	.5
HOW TO USE THE ELLIPTICAL EXERCISER .....	.11
MAINTENANCE AND TROUBLESHOOTING .....	.20
CONDITIONING GUIDELINES .....	.21
PART LIST .....	.24
EXPLODED DRAWING .....	.26
HOW TO ORDER REPLACEMENT PARTS .....	.Back Cover
LIMITED WARRANTY .....	.Back Cover

# IMPORTANT PRECAUTIONS

**⚠ WARNING:** To reduce the risk of serious injury, read the following important precautions before using the elliptical exerciser.

1. Read all instructions in this manual and all warnings on the elliptical exerciser before using the elliptical exerciser. Use the elliptical exercise only as described in this manual.
2. It is the responsibility of the owner to ensure that all users of the elliptical exerciser are adequately informed of all precautions.
3. The elliptical exerciser is intended for home use only. Do not use the elliptical exerciser in a commercial, rental, or institutional setting.
4. Keep the elliptical exerciser indoors, away from moisture and dust. Place the elliptical exerciser on a level surface, with a mat beneath it to protect the floor or carpet. Make sure that there is enough clearance around the elliptical exerciser to mount, dismount, and use it.
5. Inspect and properly tighten all parts regularly. Replace any worn parts immediately.
6. Keep children under 12 and pets away from the elliptical exerciser at all times.
7. The elliptical exerciser should not be used by persons weighing more than 275 pounds.
8. Wear appropriate exercise clothes while using the elliptical exerciser. Always wear athletic shoes for foot protection while exercising.
9. Hold the handgrip pulse sensor or the handlebars when mounting, dismounting, or using the elliptical exerciser.
10. The pulse sensor is not a medical device. Various factors may affect the accuracy of heart rate readings. The pulse sensor is intended only as an exercise aid in determining heart rate trends in general.
11. Keep your back straight while using the elliptical exerciser; do not arch your back.
12. If you feel pain or dizziness while exercising, stop immediately and cool down.
13. When you stop exercising, allow the pedals to slowly come to a stop.
14. The decal shown below has been placed on the elliptical exerciser. If the decal is missing or illegible, call the toll-free telephone number on the front cover of this manual and order a free replacement decal. Apply the decal in the location shown.

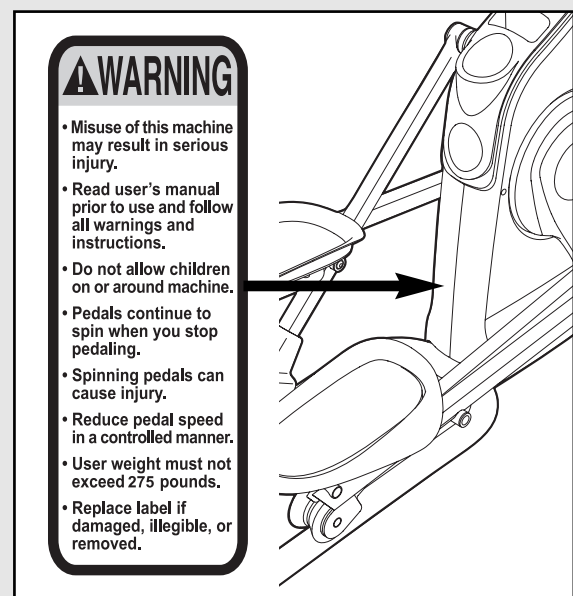

**⚠ WARNING:** Before beginning this or any exercise program, consult your physician. This is especially important for persons over the age of 35 or persons with pre-existing health problems. Read all instructions before using. ICON assumes no responsibility for personal injury or property damage sustained by or through the use of this product.

# BEFORE YOU BEGIN

Thank you for selecting the revolutionary PROFORM® 160 elliptical exerciser. The 160 elliptical exerciser provides a wide array of features designed to make your workouts at home more effective and enjoyable.

**For your benefit, read this manual carefully before you use the elliptical exerciser.** If you have questions after reading this manual, please see the front cover of this manual. To help us assist you, note the product model number and serial number before con-

tacting us. The model number is PFEL8947.0. The serial number can be found on a decal attached to the elliptical exerciser (see the front cover of this manual).

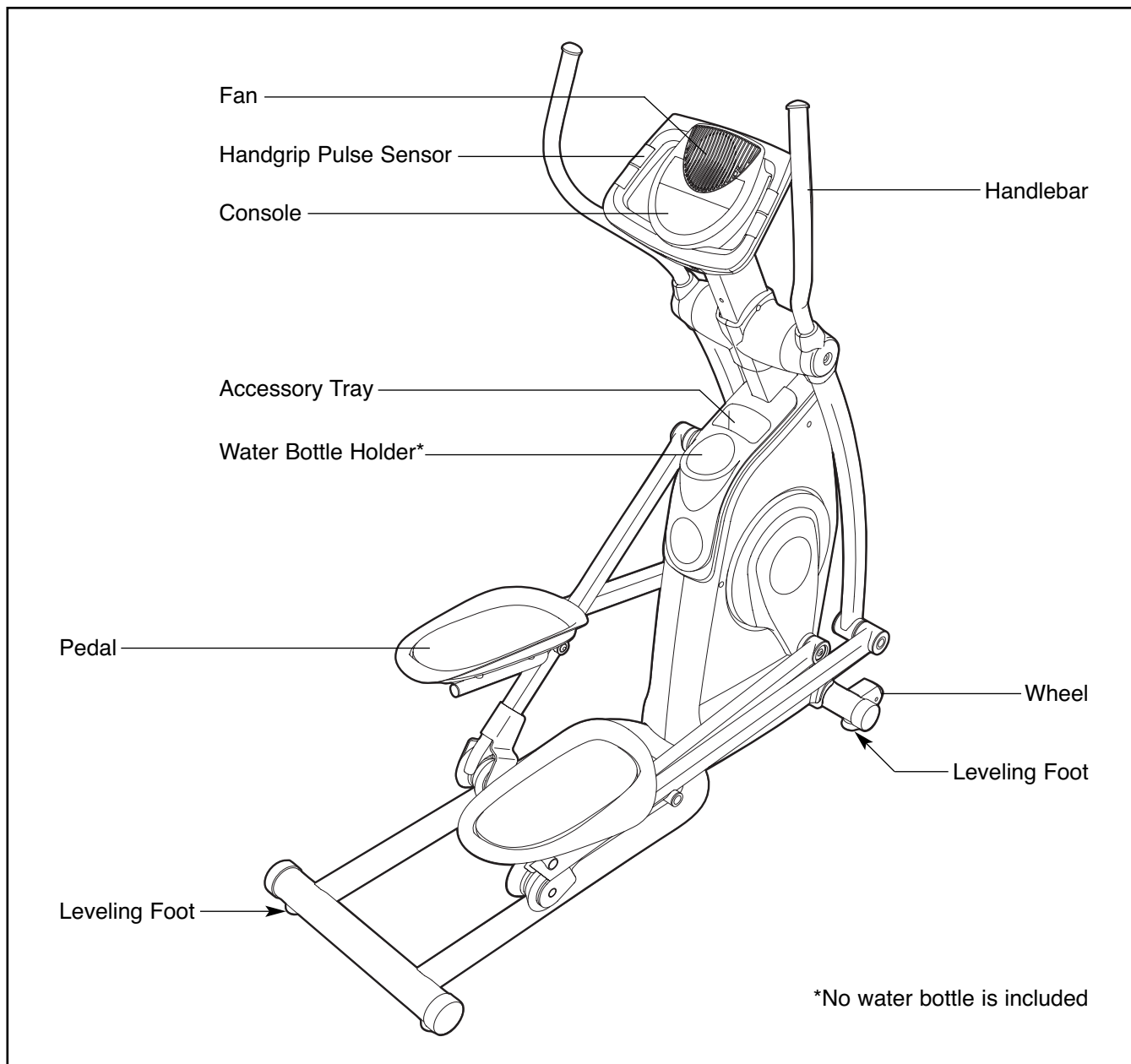

**To avoid a registration fee for any service needed under warranty, you must register the elliptical exerciser at [www.proformservice.com/registration](http://www.proformservice.com/registration).**

Before reading further, please familiarize yourself with the parts that are labeled in the drawing below.



# ASSEMBLY

To hire an authorized service technician to assemble the elliptical exerciser, call toll-free 1-800-445-2480.

**Assembly requires two persons.** Place all parts of the elliptical exerciser in a cleared area and remove the packing materials. Do not dispose of the packing materials until assembly is completed. **In addition to the included hex keys, assembly requires a Phillips screwdriver** , **an adjustable wrench** , **and a rubber mallet** .

As you assemble the elliptical exerciser, use the drawings below to identify small parts. The number in parentheses below each drawing is the key number of the part, from the PART LIST on pages 24 and 25. The number following the parentheses is the quantity needed for assembly. **Note: Some small parts may have been pre-assembled. If a part is not in the parts bag, check to see if it has been pre-assembled.**

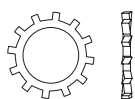

Star Washer  
(100)-3

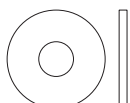

M4 x 13mm  
Washer (93)-2



M6 Split  
Washer (88)-8

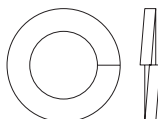

M8 Split  
Washer (72)-2

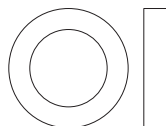

M10 Spacer  
(76)-2

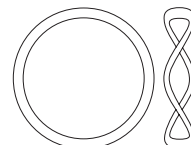

Wave Washer  
(98)-8

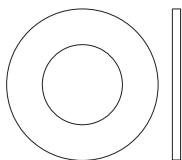

M10 x 20mm x  
1mm Washer  
(81)-2

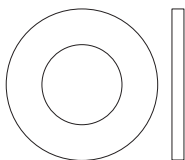

M10 x 20mm x  
1.5mm Washer  
(84)-2

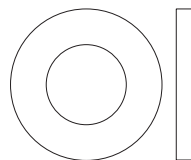

M10 x 20mm x  
2mm Washer  
(92)-4

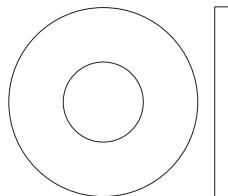

M10 x 25mm  
Washer (94)-4

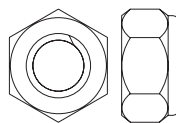

M8 Nylon  
Locknut (96)-4

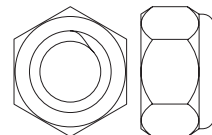

M10 Nylon  
Locknut (97)-2

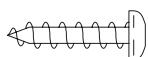

M4 x 16mm  
Self-tapping  
Screw (79)-10

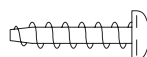

M4 x 16mm  
Screw (86)-4

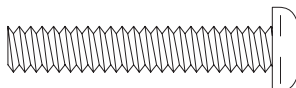

M6 x 35mm Phillips  
Screw (87)-8

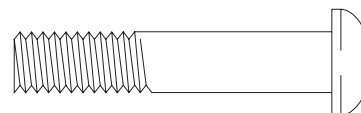

M8 x 42mm Bolt  
(71)-4

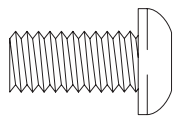

M8 x 16mm Button  
Screw (95)-3

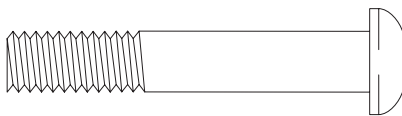

M8 x 48mm Button  
Screw (78)-2

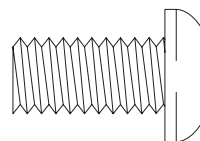

M10 x 20mm Button  
Screw (91)-4

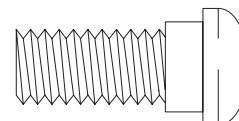

M10 x 23mm Shoulder  
Screw (80)-8

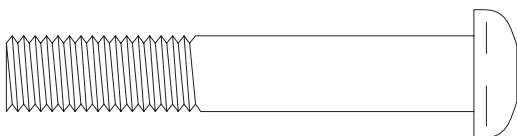

M10 x 62mm Bolt (89)-4

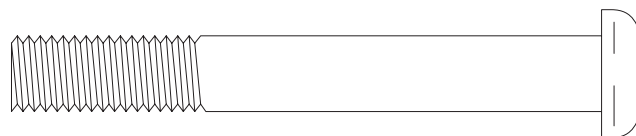

M10 x 78mm Button Screw (90)-2

1. **To make assembly easier, read the information on page 5 before you begin assembling the elliptical exerciser.**

Orient the the Front Stabilizer (35) as shown. Attach the two Wheels (25) to the Front Stabilizer with two M10 x 62mm Bolts (89) and two M10 Nylon Locknuts (97).

Attach two Feet (26) to the underside of the Front Stabilizer (35).

2. Have a second person tip the Frame (2) backward. Attach the Front Stabilizer (35) to the Frame with two M10 x 78mm Button Screws (90).

3. Orient the Base (1) near the Frame (2) as shown. See the inset drawing. Attach two Feet (26) to the underside of the Base.

Have a second person tip the Frame (2) forward. Insert the Base (1) into the Frame. Attach the Base with two M10 x 62mm Bolts (89), two M10 Spacers (76), two M8 x 48mm Button Screws (78), and two M8 Split Washers (72).

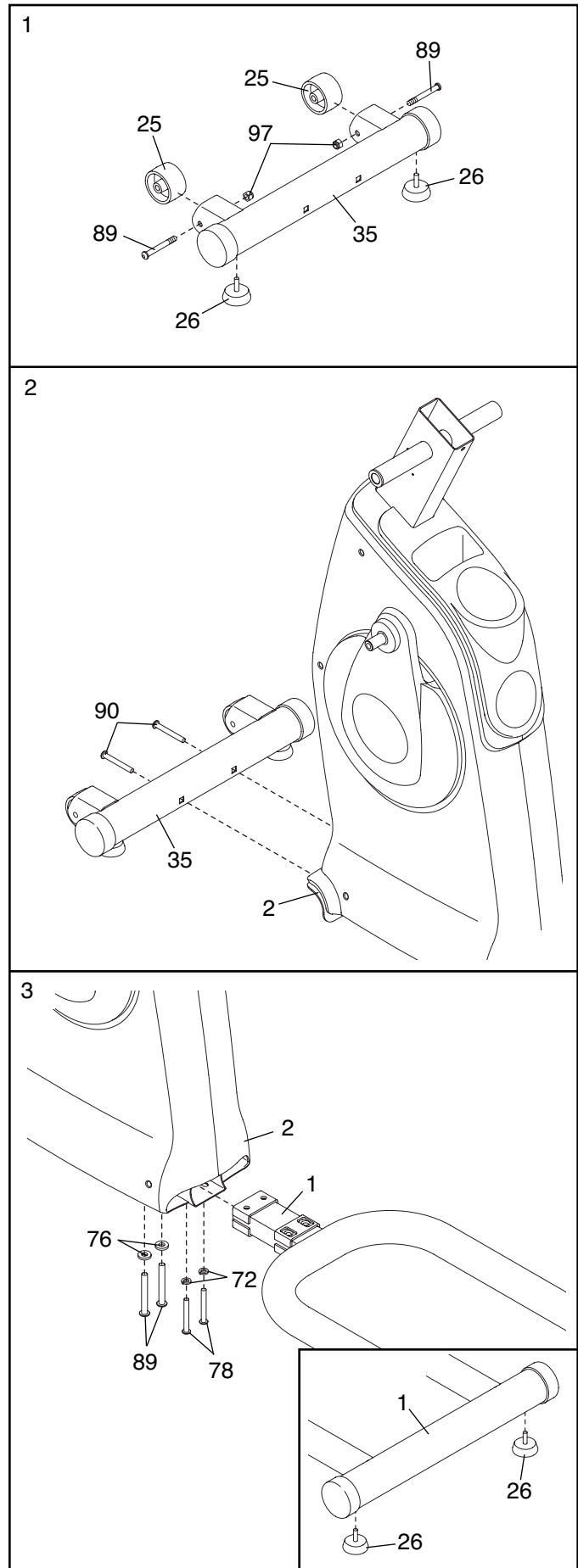

4. Have a second person hold the Upright (6) near the Frame (2) as shown.

Pull the Wire Harness (48) out of the Frame (2) and insert it upward through the Upright (6). Do not let the Wire Harness fall into the Upright; use a piece of tape or an elastic band to hold the Wire Harness in place until step 12.

Insert the Upright (6) into the Frame (2). Attach the Upright with three M8 x 16mm Button Screws (95) and three Star Washers (100). **Avoid pinching the Wire Harness (48) between the Upright and the Frame.**

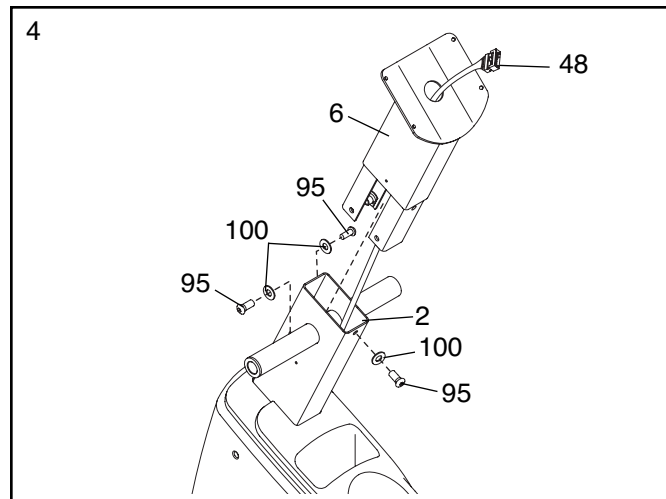

5. Orient the Left Roller Leg (12), which is marked with a "Left" sticker, near the left Crank Arm (36) as shown.

Apply a small amount of the included grease to both sides of a Wave Washer (98). Slide the Wave Washer onto the end of the left Crank Arm (36). Next, slide the Left Roller Leg (12) onto the Crank Arm and set the Roller (22) on the Base (1). Attach the Left Roller Leg with an M10 x 23mm Shoulder Screw (80), an M10 x 20mm x 1.5mm Washer (84), and a Crank Axle Cap (30).

**Repeat this step to attach the Right Roller Leg (21) to the right Crank Arm (not shown).**

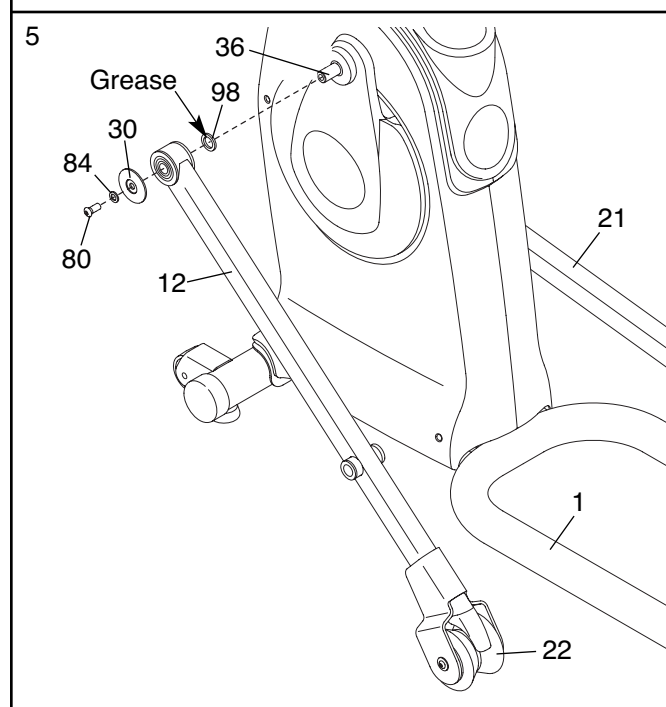

6. Identify the Left Handlebar (8), which is marked with a "Left" sticker. Insert the Left Handlebar into one of the Handlebar Legs (11) as shown.

Attach the Left Handlebar (8) with two M8 x 42mm Bolts (71) and two M8 Nylon Locknuts (96). **Make sure that the Nylon Locknuts are inside the hexagonal holes.**

**Assemble the Right Handlebar (not shown) and the other Handlebar Leg (not shown) in the same way.**

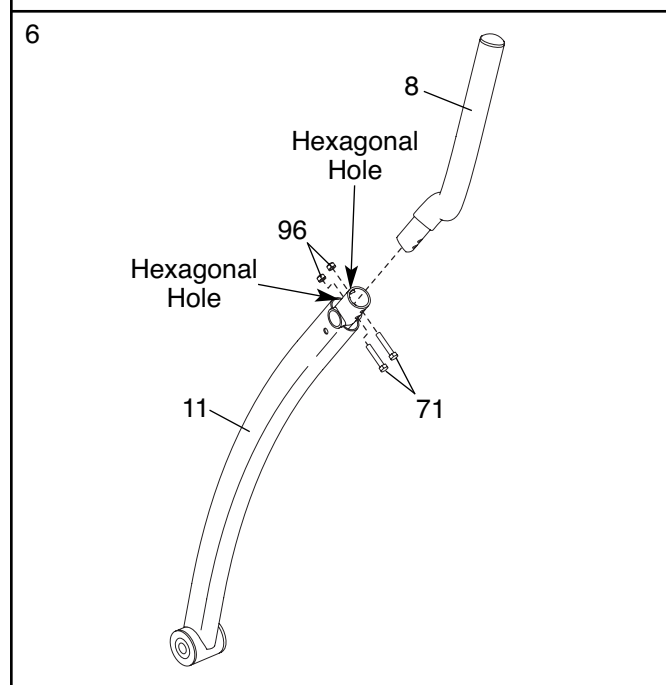

7. Position an Inner Handlebar Cover (18) and an Outer Handlebar Cover (19) around the Left Handlebar (8) as shown.

Attach the Inner and Outer Handlebar Covers (18, 19) with three M4 x 16mm Self-tapping Screws (79) and an M4 x 13mm Washer (93). **Start all three Self-tapping Screws before tightening them.**

**Repeat this step for the Right Handlebar (not shown).**

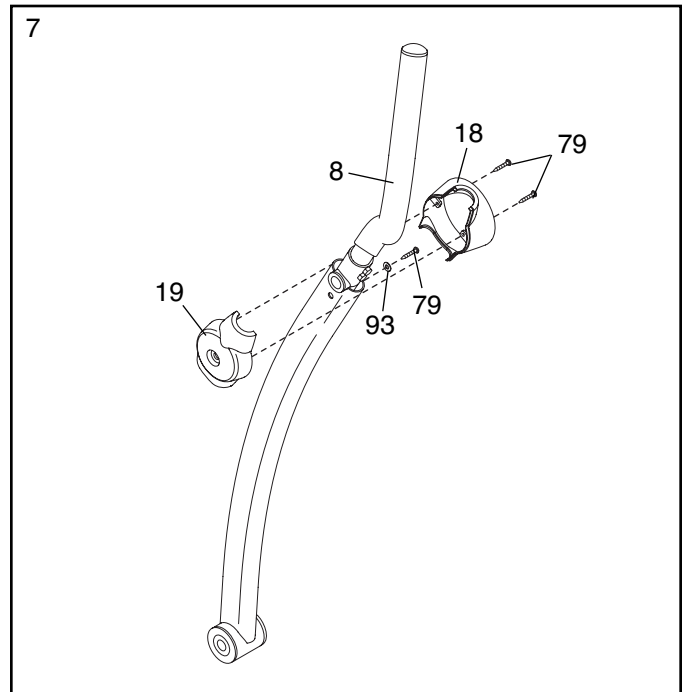

8. Apply a generous amount of grease to the Pivot Axle (65) and insert it into the Frame (2).

Attach the two Frame Covers (17) to the Frame (2) with four M4 x 16mm Screws (86) as shown.

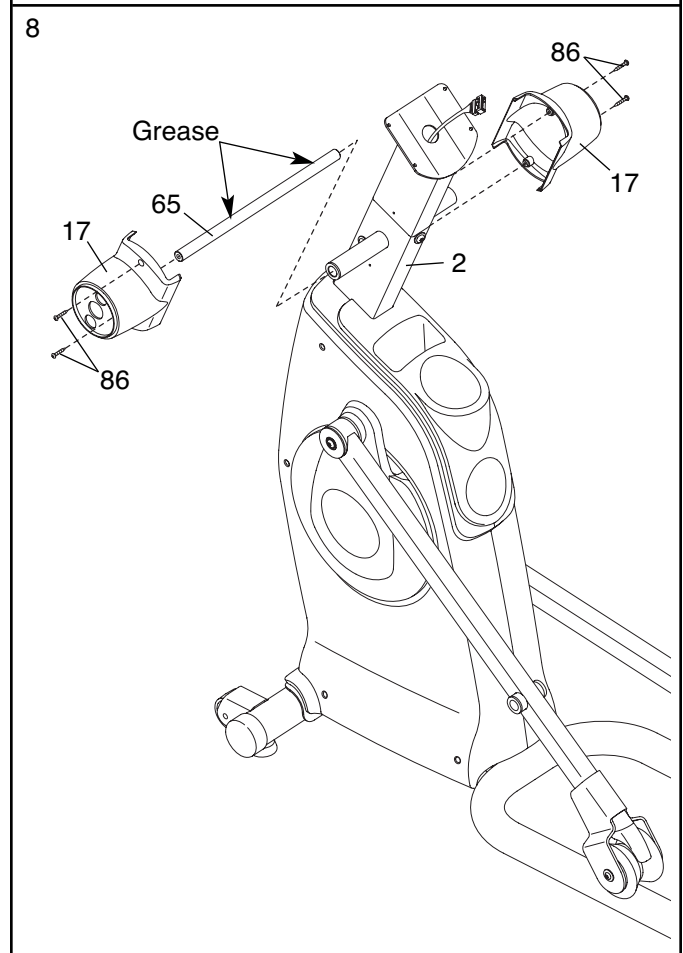



9. Apply a small amount of grease to both sides of a Wave Washer (98). Slide the Wave Washer onto the left side of the Pivot Axle (65). Next, slide the Left Handlebar (8) onto the Pivot Axle as shown.

Attach the Left Handlebar (8) with an M10 x 23mm Shoulder Screw (80) and an M10 x 20mm x 1mm Washer (81).

**Repeat this step to attach the Right Handlebar (9) to the Pivot Axle (65).**

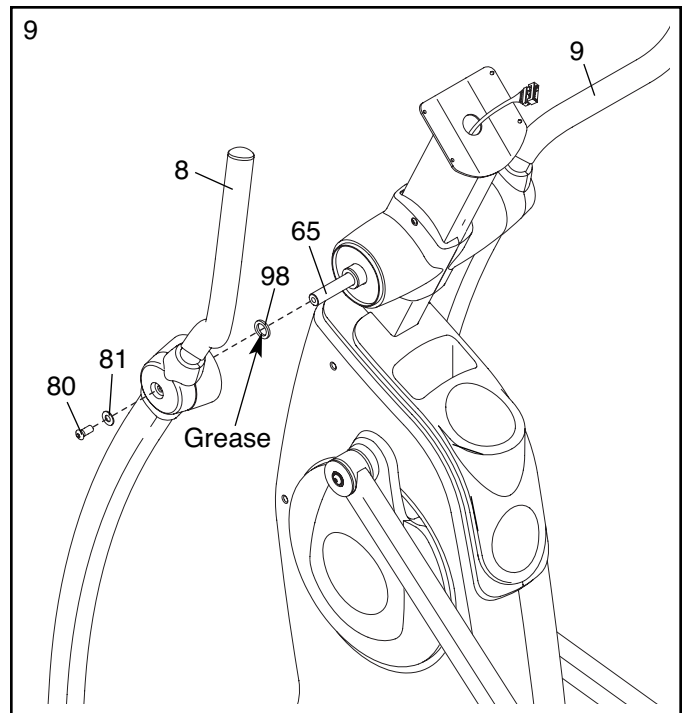

10. Identify the Left Pedal (13) and the Left Pedal Leg (14), which are marked with "Left" stickers, and orient them as shown.

Attach the Left Pedal (13) to the Left Pedal Leg (14) with four M6 x 35mm Phillips Screws (87) and four M6 Split Washers (88). **Start all four Phillips Screws before tightening them.**

**Repeat this step to attach the Right Pedal (not shown) to the Right Pedal Leg (not shown).**

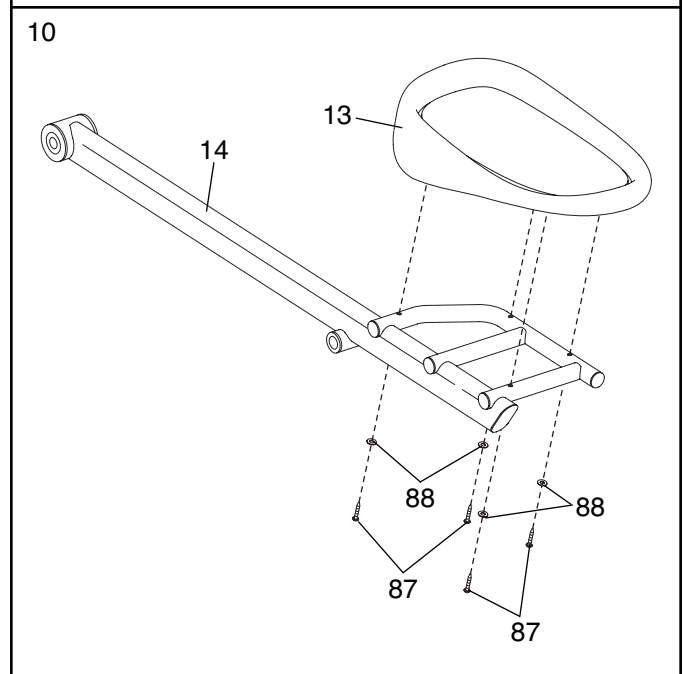

11. Apply a generous amount of grease to two Pedal Leg Axles (32). Insert one Pedal Leg Axle into the bottom of the Left Handlebar Leg (11). Insert the other Pedal Leg Axle into the left Roller Leg (21).

Apply a small amount of grease to both sides of two Wave Washers (98). Place a Wave Washer on each Pedal Leg Axle (32).

Orient the Left Pedal Leg (14) as shown, and slide it onto the Pedal Leg Axles (32). Attach the Left Pedal Leg to the Left Handlebar Leg (11) with two M10 x 23mm Shoulder Screws (80), two M10 x 20mm x 2mm Washers (92), and two Axle Caps (31).

Attach the Left Pedal Leg (14) to the left Roller Leg (21) with two M10 x 20mm Button Screws (91) and two M10 x 25mm Washers (94); **do not overtighten the Button Screws**. The Legs (11, 14, 21) must be able to pivot freely.

**Repeat this step for the Right Pedal Leg (not shown).**

12. The Console (5) requires four 1.5V "D" batteries (not included); alkaline batteries are recommended. See the inset drawing. Remove the battery cover from the Console and insert four batteries into the Console. Make sure that the batteries are oriented as shown by the diagram in the battery compartment. Then, reattach the battery cover.

Have a second person hold the Console (5) near the Upright (6) as shown. Connect the console wire to the Wire Harness (48). Insert the excess wire downward into the Upright.

Attach the Console (5) to the Upright (6) with four M4 x 16mm Self-tapping Screws (79).

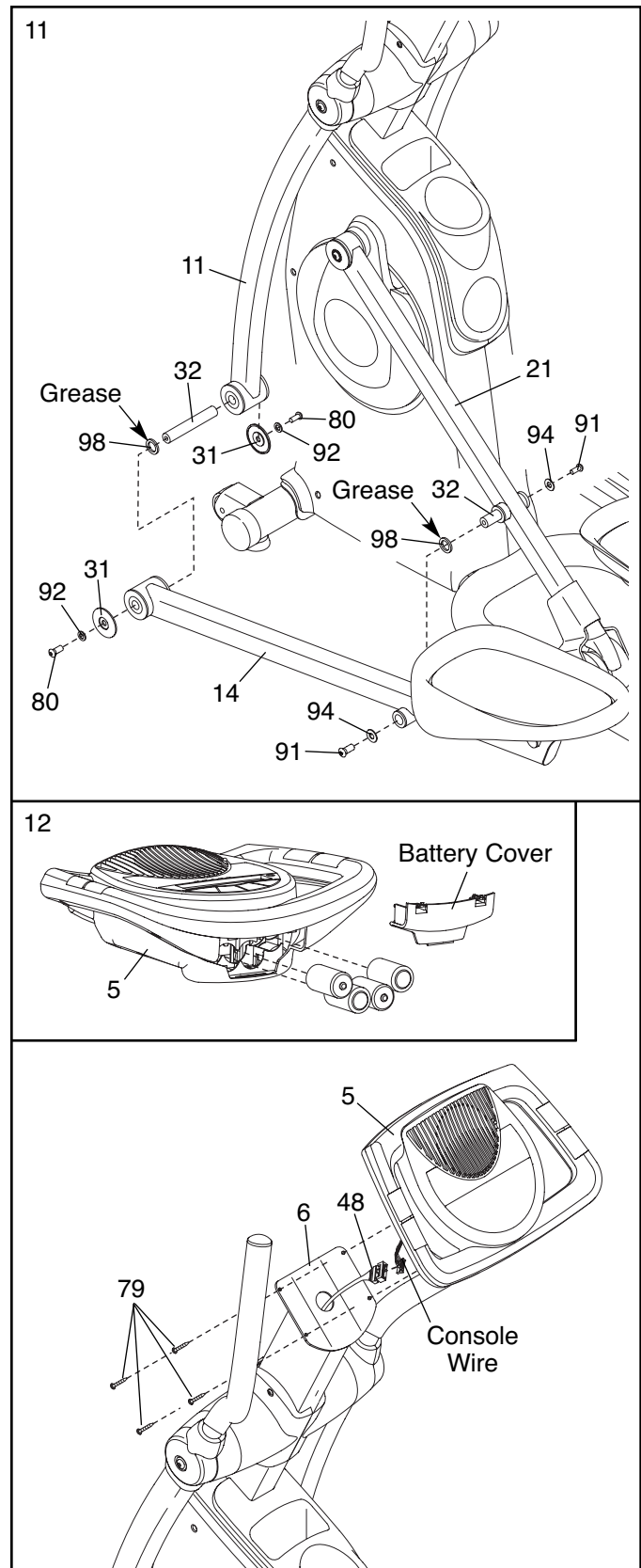

13. **Make sure that all parts of the elliptical exerciser are properly tightened.** Note: Some hardware may be left over after assembly is completed. To protect the floor or carpet from damage, place a mat under the elliptical exerciser.

# HOW TO USE THE ELLIPTICAL EXERCISER

## HOW TO MOVE THE ELLIPTICAL EXERCISER

Due to the size and weight of the elliptical exerciser, moving it requires two persons. Stand in front of the elliptical exerciser, hold the upright, and place one foot against one of the front wheels. Pull on the upright and have a second person lift the base until the elliptical exerciser will roll on the front wheels. Carefully move the elliptical exerciser to the desired location, and then lower it to the floor.

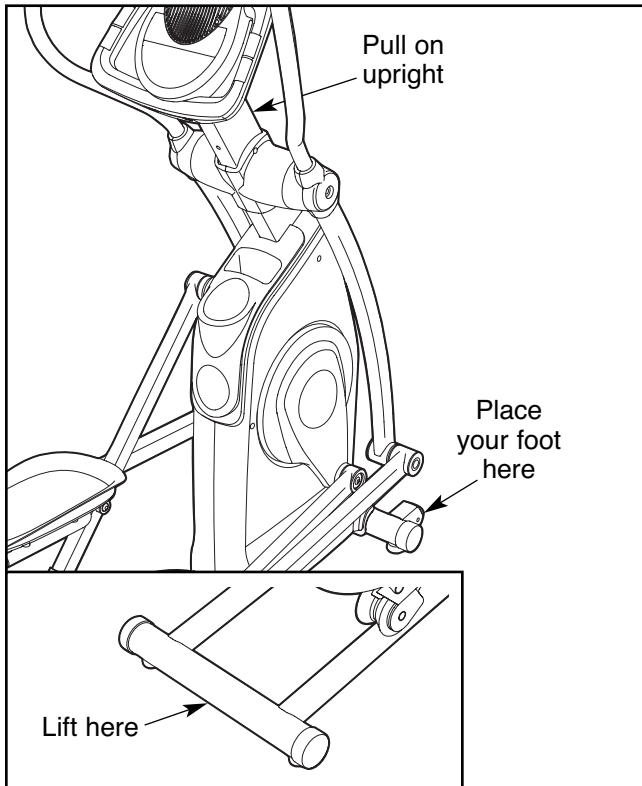

## HOW TO LEVEL THE ELLIPTICAL EXERCISER

If the elliptical exerciser rocks slightly on your floor during use, turn one or both of the leveling feet beneath the base or beneath the front stabilizer until the rocking motion is eliminated.

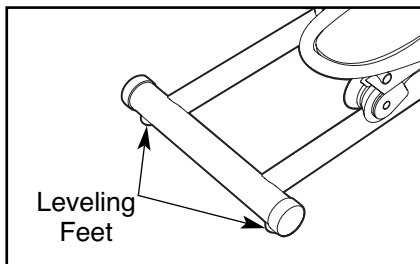

## HOW TO EXERCISE ON THE ELLIPTICAL EXERCISER

To mount the elliptical exerciser, hold the handlebars and step onto the pedal that is in the lower position. Then, step onto the other pedal. Push the pedals until they begin to move with a continuous motion. **Note: The crank arm covers can turn in either direction. It is recommended that you turn the crank arm covers in the direction shown by the arrow below; however, for variety, you can turn the crank arm covers in the opposite direction.**

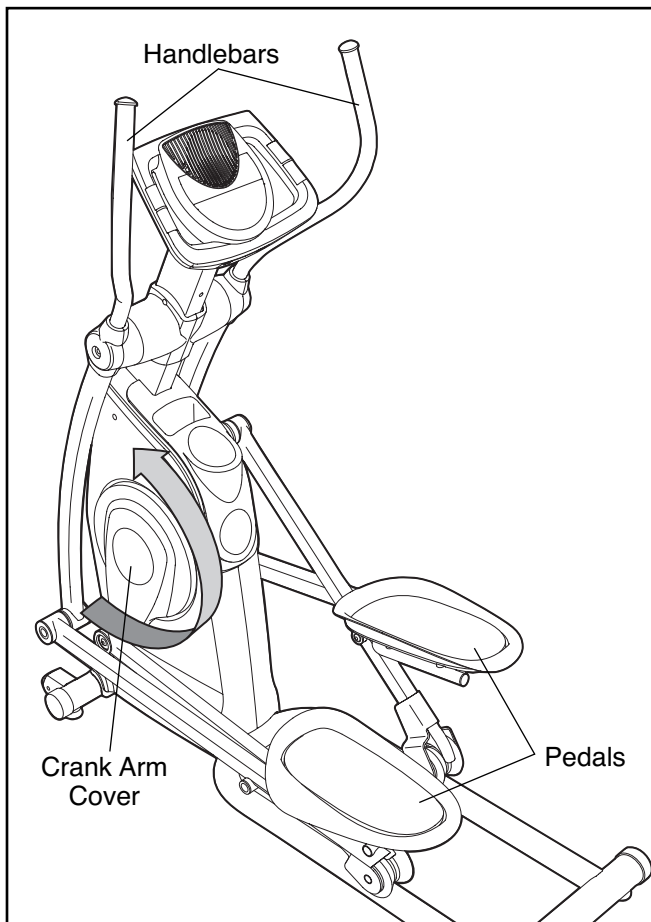

To dismount the elliptical exerciser, wait until the pedals come to a complete stop. **Note: The elliptical exerciser does not have a free wheel; the pedals will continue to move until the flywheel stops.** When the pedals are stationary, step off the higher pedal first. Then, step off the lower pedal.

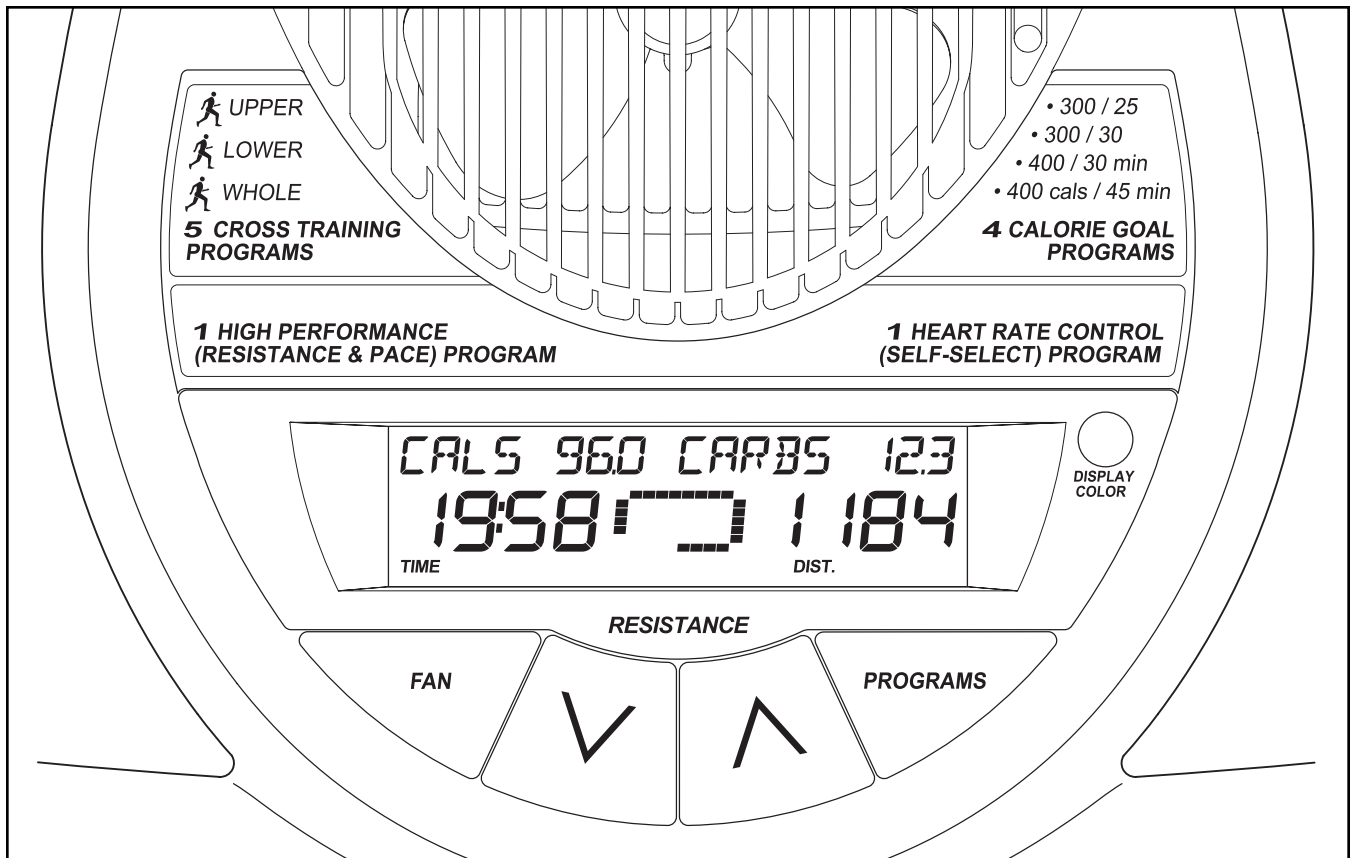

## FEATURES OF THE CONSOLE

The advanced console offers an array of features designed to make your workouts more effective and enjoyable.

When you select the manual mode of the console, you can change the resistance of the pedals with the touch of a button. As you exercise, the console will display continuous exercise feedback. You can even measure your heart rate using the handgrip pulse sensor.

The console also features five interactive cross training programs designed to help you to burn calories and enhance your cardiovascular system while toning and strengthening your muscles. The cross training programs automatically control the resistance of the pedals and prompt you to perform a variety of strength exercises during your workout. Choose an upper body, lower body, or whole body cross training program to focus your workout. Note: The strength exercises require the use of dumbbells and an inflatable exercise ball (not included). **To purchase dumbbells or an exercise ball, call toll-free 1-888-533-1333.**

You can also use four calorie goal programs designed to help you burn 300 or 400 calories in 25, 30, or 45-minute workouts. The calorie goal programs automatically control the resistance of the pedals and prompt you to increase or decrease your pace while counting the calories you burn.

The console also offers a high performance program and a heart rate control program. The high performance program automatically changes the resistance of the pedals and prompts you to increase or decrease your pace as it guides you through an effective workout. The heart rate control program changes the resistance of the pedals and prompts you maintain a steady pace to keep your heart rate near a target heart rate while you exercise.

**To use the manual mode of the console**, follow the steps beginning on page 13. **To use a cross training program**, see page 15. **To use a calorie goal program**, see page 17. **To use the high performance program**, see page 18. **To use the heart rate control program**, see page 19.

**Note: If there is a sheet of clear plastic on the face of the console, remove the plastic.**

## HOW TO USE THE MANUAL MODE

### 1 Press the Resistance decrease button or begin pedaling to turn on the console.

A moment after you turn on the console, the display will light.

### 2 Select the manual mode.

Each time you turn on the console, the manual mode will be selected automatically. If you have selected a program, reselect the manual mode by pressing the Programs button repeatedly until the words MANUAL MODE appear in the top of the display.

### 3 Begin pedaling and change the resistance of the pedals as desired.

As you pedal, change the resistance of the pedals by pressing the Resistance increase and decrease buttons repeatedly. There are ten resistance levels. Note: After you press the buttons, it will take a moment for the pedals to reach the selected resistance level.

### 4 Follow your progress with the display.

#### The left side of the display

—The left side of the display will show the elapsed time. Note: When a program is selected, the display will show the time remaining in the program instead of the elapsed time. An exception is the heart rate control program, which shows the elapsed time.



The left side of the display will also show your heart rate when you use the handgrip pulse sensor (see step 5 on page 14).

When a program is selected, the left side of the display will also show the approximate number of calories you have burned.

#### The center of the display

—When you select the manual mode, the center of the display will show a track that represents 640 revolutions. As you exercise, indicators will appear in succession around the track until the entire track appears. The track will then disappear and the indicators will again begin to appear in succession.

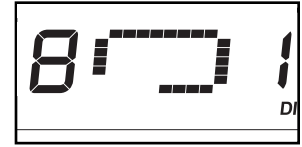

The center of the display will also show the resistance setting of the pedals for a few seconds each time the resistance setting changes.

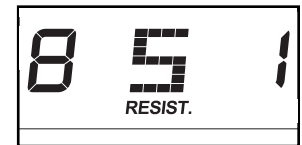

#### The right side of the display

—The right side of the display will show the distance (total revolutions) you have pedaled and your pedaling pace, (revolutions per minute [rpm]).



#### The top of the display

—When you select the manual mode, the top of the display will show the approximate number of calories you have burned and the approximate number of grams of carbs you have burned.

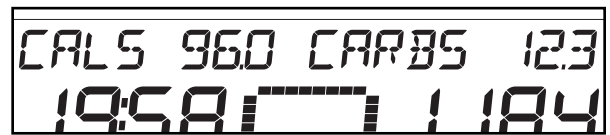

## 5 Measure your heart rate if desired.

If there are sheets of clear plastic on the metal contacts on the handgrip pulse sensor, remove the plastic.

To measure your heart rate, hold the handgrip pulse sensor with your palms resting against the metal contacts. **Avoid moving your hands or gripping the contacts too tightly.**

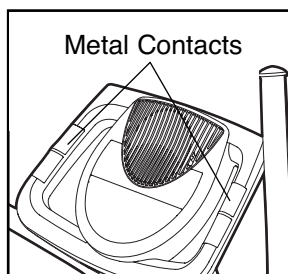

When your pulse is detected, a heart-shaped symbol will flash in the left side of the display each time your heart

beats, one or two dashes will appear, and then your heart rate will be shown. For the most accurate heart rate reading, hold the contacts for at least 15 seconds. Note: If you continue to hold the handgrip pulse sensor, the display will show your heart rate for up to 30 seconds.



If your heart rate is not shown, make sure that your hands are positioned as described. Be careful not to move your hands excessively or to squeeze the metal contacts too tightly. For optimal performance, clean the metal contacts using a soft cloth; **never use alcohol, abrasives, or chemicals to clean the contacts.**

## 6 Change the display color if desired.

Press the Display Color button repeatedly to select a backlight color for the display.

## 7 Turn on the fan if desired.

To turn on the fan at high speed, press the Fan button. To turn on the fan at low speed, press the button a second time. To turn off the fan, press the button a third time. Note: If the pedals do not move for a few minutes, the fan will automatically turn off to conserve the batteries.

Pivot the thumb tab on the right side of the fan to adjust the fan angle.

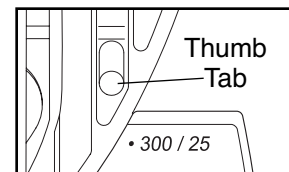

## 8 When you are finished exercising, the console will turn off automatically.

If the pedals do not move for several seconds, a tone will sound and the console will pause.

If the pedals do not move for about five minutes and the buttons are not pressed, the console will turn off and the display will be reset.

## HOW TO USE A CROSS TRAINING PROGRAM

### 1 Press the Resistance decrease button or begin pedaling to turn on the console.

A moment after you turn on the console, the display will light.

### 2 Select one of the five cross training programs.

To select a cross training program, press the Programs button repeatedly until the name of the desired cross training program appears in the display. When a cross training program is selected, the program time will appear in the display and a profile of the resistance settings for the program will scroll across the matrix in the display.

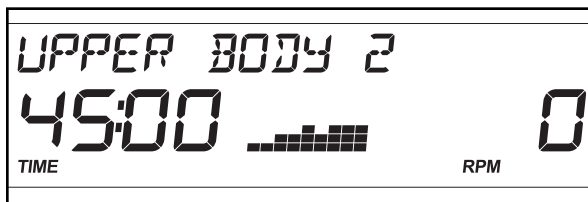

### 3 Begin pedaling to start the program.

Each program is divided into 25, 30, or 45 one-minute segments. One resistance setting and one target rpm (revolutions per minute) setting are programmed for most segments. (Note: The same resistance and/or target rpm setting may be programmed for two or more consecutive segments.) During other segments, the console will prompt you to perform strength exercises.

The resistance setting for the first segment will be shown in the flashing Current Segment column of the matrix. The resistance settings for the next several segments will be shown in the columns to the right. The target rpm setting will appear in the top of the display.

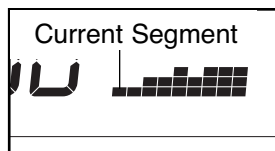

When only three seconds remain in the first segment of the program, both the Current Segment column and the column to the right will flash and a series of tones will sound. If the resistance and/or target rpm is about to change, the resistance setting and/or the target rpm setting will appear in the display to alert you.

When the first segment is completed, *all resistance settings will move one column to the left.* The resistance setting for the second segment will then be shown in the flashing Current Segment column and the resistance of the pedals will automatically adjust to the setting for the second segment. Note: If all the indicators in the Current Segment column are lit, *the resistance settings may move downward* so that only the highest indicators appear in the matrix.

As you exercise, you will be prompted to keep your pedaling pace near the target rpm setting for the current segment. When the words PEDAL FASTER appear in the display, increase your pace. When the words PEDAL SLOWER appear in the display, decrease your pace. When the words PEDALING IN RANGE appear, maintain your current pace.

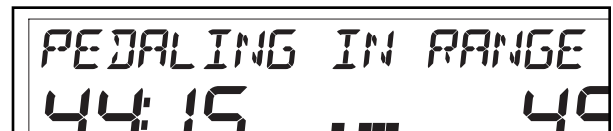

**Important: The target rpm settings are intended only to provide motivation. Your actual pace may be slower than the target rpm settings. Make sure to exercise at a pace that is comfortable for you.**

If the resistance setting for the current segment is too high or too low, you can manually override the setting by pressing the Resistance decrease or increase buttons. Every few times you press a Resistance button, an additional indicator will appear or disappear in the Current Segment column; if any of the columns to the right of the Current Segment column have the same number of lit indicators as the Current Segment column, an additional indicator may appear or disappear in those columns as well. **Important: When the current segment of the program ends, the elliptical exerciser will automatically adjust to the resistance setting for the next segment.**

To stop the program at any time, stop pedaling. The time will begin to flash in the display. To restart the program, simply resume pedaling.

**4 Perform the first strength exercise when prompted.**

When the first strength exercise segment begins, the name of the first strength exercise will appear in the display for a few seconds. The time will pause and flash in the display.

Next, the display will show the recommended number of repetitions for the first strength exercise.

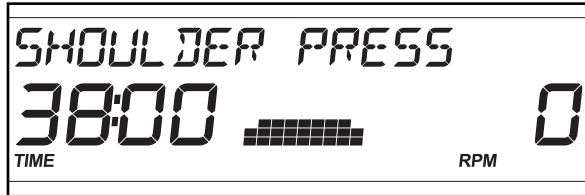

Step off the elliptical exerciser and prepare to begin the first strength exercise. Every few seconds, the console will sound a

tone; when a tone sounds, perform one repetition of the exercise. Exercise with a slow, steady motion; do not perform more than one repetition each time a tone sounds. The display will count down the repetitions as you perform them.



Note: Refer to the accompanying exercise chart to see the correct form for each exercise. When performing lunges, alternate legs with each repetition. When performing dumbbell rows, perform half the repetitions with your right arm and half the repetitions with your left arm. The strength exercises require the use of dumbbells and an inflatable exercise ball (not included). **To purchase dumbbells or an exercise ball, call toll-free 1-888-533-1333.**

**5 Continue the cross training program.**

When you have performed the recommended number of repetitions, the words START PEDALING will appear in the display. To continue the cross training program, step onto the elliptical exerciser and start pedaling. The pedals will automatically adjust to the resistance setting for the next segment.



The program will continue in this way until the last segment ends. Then, the words PROGRAM DONE will appear in the display.

**6 Follow your progress with the display.**

See step 4 on page 13.

**7 Measure your heart rate if desired.**

See step 5 on page 14.

**8 Change the display color if desired.**

See step 6 on page 14.

**9 Turn on the fan if desired.**

See step 7 on page 14.

**10 When you are finished exercising, the console will turn off automatically.**

See step 8 on page 14.



## HOW TO USE A CALORIE GOAL PROGRAM

### 1 Press the Resistance decrease button or begin pedaling to turn on the console.

A moment after you turn on the console, the display will light.

### 2 Select one of the calorie goal programs.

Press the Programs button repeatedly until the name of the desired calorie goal program appears in the display. When a calorie goal program is selected, the program time will appear in the display and a profile of the resistance settings for the program will scroll across the matrix in the display.



### 3 Begin pedaling to start the program.

Each program is divided into 25, 30, or 45 one-minute segments. One resistance setting and one target rpm (revolutions per minute) setting are programmed for each segment. Note: The same resistance setting and/or target rpm setting may be programmed for two or more consecutive segments. The display for a calorie goal program work in the same way as the display for the cross training programs (see step 3 on page 15).

As you exercise, you will be prompted to near the target rpm setting for the current segment. When the words PEDAL FASTER appear in the display, increase your pace. When the words PEDAL SLOWER appear in the display, decrease your pace. When the words PEDALING IN RANGE appear, maintain your current pace.

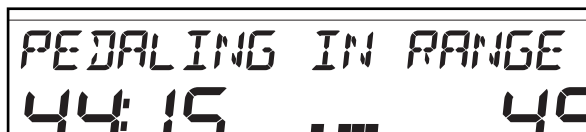

**Important:** The target rpm settings are intended only to provide motivation. Your actual pace may be slower than the target rpm settings. Make sure to exercise at a pace that is comfortable for you. Note: If you manually override the resistance settings of a calorie goal program, you may not reach your calorie goal.

To stop the program at any time, stop pedaling. The time will begin to flash in the display. To restart the program, simply resume pedaling.

When the last segment of the program ends, the words PROGRAM DONE will appear in the display.

### 4 Follow your progress with the display.

See step 4 on page 13.

### 5 Measure your heart rate if desired.

See step 5 on page 14.

### 6 Change the display color if desired.

See step 6 on page 14.

### 7 Turn on the fan if desired.

See step 7 on page 14.

### 8 When you are finished exercising, the console will turn off automatically.

See step 8 on page 14.

## HOW TO USE THE HIGH PERFORMANCE PROGRAM

- 1 Press the Resistance decrease button or begin pedaling to turn on the console.**

A moment after you turn on the console, the display will light.

- 2 Select the high performance program.**

Press the Programs button repeatedly until the words HIGH PERFORMANCE appear in the display. The program time will appear in the display and a profile of the resistance settings for the program will scroll across the matrix in the display.

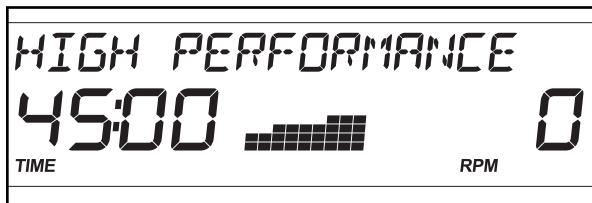

- 3 Begin pedaling to start the program.**

The program is divided into 45 one-minute segments. One resistance setting and one target rpm setting are programmed for each segment. Note: The same resistance setting and/or target rpm setting may be programmed for two or more consecutive segments. The displays for the high performance program work in the same way as the displays for the cross training programs (see step 3 on page 16).

As you exercise, you will be prompted to keep your pedaling pace near the target rpm setting for the current segment. When the words PEDAL FASTER appear in the display, increase your pace. When the words PEDAL SLOWER appear in the display, decrease your pace. When the

words PEDALING IN RANGE appear, maintain your current pace.

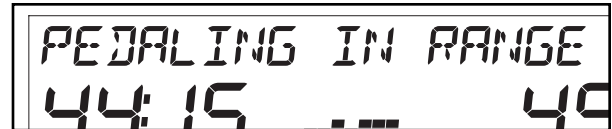

**Important: The target rpm settings are intended only to provide motivation. Your actual pace may be slower than the target rpm settings. Make sure to exercise at a pace that is comfortable for you.**

To stop the program at any time, stop pedaling. The time will begin to flash in the display. To restart the program, simply resume pedaling.

When the last segment of the program ends, the words PROGRAM DONE will appear in the display.

- 4 Follow your progress with the display.**

See step 4 on page 13.

- 5 Measure your heart rate if desired.**

See step 5 on page 14.

- 6 Change the display color if desired.**

See step 6 on page 14.

- 7 Turn on the fan if desired.**

See step 7 on page 14.

- 8 When you are finished exercising, the console will turn off automatically.**

See step 8 on page 14.

## HOW TO USE THE HEART RATE CONTROL PROGRAM

### 1 Press the Resistance decrease button or begin pedaling to turn on the console.

A moment after you turn on the console, the display will light.

### 2 Select the heart rate control program.

Press the Programs button repeatedly until the words HEART RATE CONTROL appear in the display.

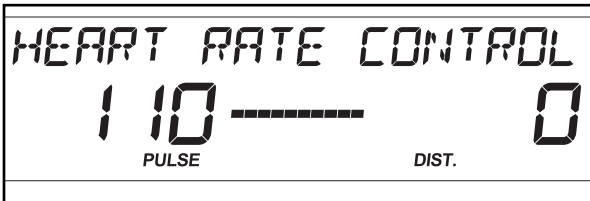

### 3 Enter a target heart rate.

The target heart rate setting for the program will flash in the display. Use the Resistance increase and decrease buttons to change the target heart rate setting.



### 4 Hold the handgrip pulse sensor.

It is not necessary to hold the handgrip pulse sensor continuously; however, you should hold the handgrip pulse sensor frequently for the program to operate properly. **Each time you hold the handgrip pulse sensor, keep your hands on the metal contacts for at least 30 seconds.** When you are not holding the handgrip pulse sensor, the letters PLS will appear in the display instead of your heart rate.



### 5 Begin pedaling to start the program.

During the program, the console will regularly compare your heart rate to the target heart rate. If your heart rate is too far below or above the target heart rate, the resistance of the pedals will automatically increase or decrease to bring your heart rate closer to the target heart rate.

You will also be prompted to pedal at a steady pace so you can maintain your target heart rate. When the words PEDAL FASTER appear in the display, increase your pace. When the words PEDAL SLOWER appear in the display, decrease your pace. When the words PEDALING IN RANGE appear, maintain your current pace.

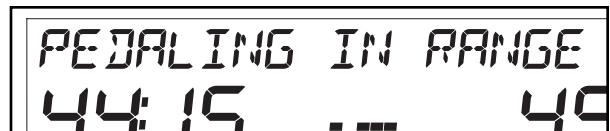

**Important: Make sure to exercise at a pace that is comfortable for you.** Note: If you manually override the resistance settings, you may not maintain your target heart rate.

To stop the program at any time, stop pedaling. The time will begin to flash in the display. To restart the program, simply resume pedaling.

### 6 Follow your progress with the display.

See step 4 on page 13.

### 7 Measure your heart rate if desired.

See step 5 on page 14.

### 8 Change the display color if desired.

See step 6 on page 14.

### 9 Turn on the fan if desired.

See step 7 on page 14.

### 10 When you are finished exercising, the console will turn off automatically.

See step 8 on page 14.

# MAINTENANCE AND TROUBLESHOOTING

Inspect and tighten all parts of the elliptical exerciser regularly. Replace any worn parts immediately.

To clean the elliptical exerciser, use a damp cloth and a small amount of mild soap. **Important: To avoid damage to the console, keep liquids away from the console and keep the console out of direct sunlight.**

## CONSOLE TROUBLESHOOTING

If the console display becomes dim, the batteries should be replaced; most console problems are the result of low batteries. See assembly step 12 on page 10 for replacement instructions.

## HANDGRIP PULSE SENSOR TROUBLESHOOTING

If the console does not display your heart rate when you hold the handgrip pulse sensor, or if the displayed heart rate appears to be too high or too low, see step 5 on page 14.

## HOW TO LEVEL THE ELLIPTICAL EXERCISER

If the elliptical exerciser rocks slightly on your floor during use, see HOW TO LEVEL THE ELLIPTICAL EXERCISER on page 11.

## HOW TO ADJUST THE DRIVE BELT

If the pedals slip while you are pedaling, even while the resistance is adjusted to the highest setting, the

drive belt may need to be adjusted. To adjust the drive belt, first remove the screws from the left and right side shields (not shown). Gently pull the side shields apart and remove the convenience tray.

Next, locate the Idler Screw (68) and loosen it one half turn. Step onto the elliptical exerciser and move the pedals. If the pedals continue to slip, turn the Idler Screw another half turn and test the pedals again. Continue in this way until the pedals no longer slip. Then, replace the convenience tray and reattach the side shields.

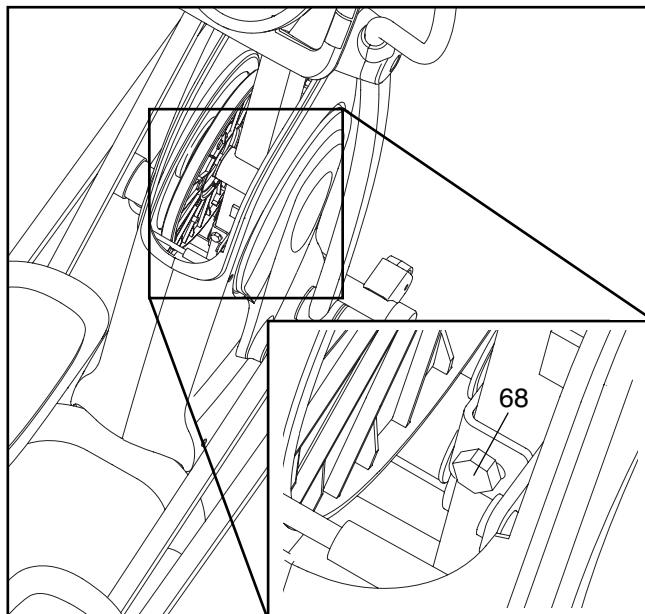

# CONDITIONING GUIDELINES

## WARNING:

Before beginning this or any exercise program, consult your physician. This is especially important for persons over the age of 35 or persons with pre-existing health problems.

The pulse sensor is not a medical device. Various factors may affect the accuracy of heart rate readings. The pulse sensor is intended only as an exercise aid in determining heart rate trends in general.

The following guidelines will help you to plan your exercise program. Remember that proper nutrition and adequate rest are essential for successful results. Each workout should include the following three parts:

**Warming Up**—Begin each workout with 5 to 10 minutes of stretching and light exercise. A proper warm-up increases your body temperature, heart rate, and circulation in preparation for exercise.

**Training Zone Exercise**—Each workout should consist of 20 to 30 minutes of exercising with your heart rate in your training zone. Note: During the first few weeks of your exercise program, do not keep your heart rate in your training zone for longer than 20 minutes.

**Cooling Down**—End each workout with 5 to 10 minutes of stretching. This will increase the flexibility of your muscles and will help to prevent post-exercise problems.



To maintain or improve your condition, plan three workouts each week, with at least one day of rest between workouts. Schedule your workouts for the time of day when your energy level is the highest. After a few months of regular exercise, you may complete up to five workouts each week, if desired. Remember, the key to success is make exercise a regular and enjoyable part of your everyday life.

## CARDIOVASCULAR TRAINING GUIDELINES

Whether your goal is to burn fat or to strengthen your cardiovascular system, the key to achieving the

desired results is to exercise with the proper intensity. The proper intensity level can be found by using your heart rate as a guide.

The chart below shows recommended heart rates for fat burning, maximum fat burning, and cardiovascular (aerobic) exercise.

165	155	145	140	130	125	115	
145	138	130	125	118	110	103	
125	120	115	110	105	95	90	
20	30	40	50	60	70	80	

To find the proper heart rate for you, first find your age at the bottom of the chart (ages are rounded off to the nearest ten years). Next, find the three numbers above your age. The three numbers are your “training zone.” The lowest number is the recommended heart rate for fat burning, the middle number is the recommended heart rate for maximum fat burning, and the highest number is the recommended heart rate for aerobic exercise.

**Fat Burning**—To burn fat effectively, you must exercise at a relatively low intensity level for a sustained period of time. During the first few minutes of exercise, your body uses easily accessible *carbohydrate* calories for energy. Only after the first few minutes of exercise does your body begin to use stored *fat* calories for energy. If your goal is to burn fat, adjust the intensity of your exercise until your heart rate is near the lowest number in your training zone as you exercise. For maximum fat burning, adjust the intensity of your exercise until your heart rate is near the middle number in your training zone as you exercise.

**Aerobic Exercise**—If your goal is to strengthen your cardiovascular system, your exercise must be “aerobic.” Aerobic exercise is activity that requires large amounts of oxygen for prolonged periods of time. This increases the demand on the heart to pump blood to the muscles, and on the lungs to oxygenate the blood. For aerobic exercise, adjust the intensity of your exercise until your heart rate is near the highest number in your training zone.

## **STRENGTH TRAINING GUIDELINES**

During strength exercises, you must maintain proper form for the best results. Maintaining proper form involves moving through the full range of motion for each exercise and moving only the appropriate parts of the body. Exercising in an uncontrolled manner will reduce the benefits of strength exercises. On the exercise chart accompanying this manual are photographs showing the correct form for several strength exercises.

Perform each repetition of each strength exercise smoothly and without pausing. The exertion phase of each repetition should last only about half as long as the return phase. Proper breathing is also important. Exhale during the exertion phase of each repetition and inhale during the return phase—never hold your breath.

To increase the size and strength of your muscles, you must work your muscles at a level close to their maximum capacity. Your muscles will adapt and grow as you progressively increase the amount of weight that you use. You can tone your muscles by working them at a moderate percentage of their capacity. The proper amount of weight to use for each strength exercise depends on you—you must gauge your limits and select an appropriate amount of weight.

It is important to avoid overdoing it during the first few months of your exercise program. Progress at your own pace and be sensitive to your body's signals. If you experience pain or dizziness at any time while exercising, stop immediately and cool down. Find out what is wrong before continuing. Remember that adequate rest and a proper diet are important factors in any exercise program.

---

# NOTES

# PART LIST—Model No. PFEL8947.0

R0906B

Key No.	Qty.	Description	Key No.	Qty.	Description
1	1	Base	49	2	Base Endcap
2	1	Frame	50	1	Reed Switch/Wire
3	2	Outer Crank Arm Cover	51	1	Belt
4	2	Inner Crank Arm Cover	52	1	Flywheel
5	1	Console	53	1	"C" Magnet
6	1	Upright	54	2	Outer Bearing Set
7	2	Roller Cover	55	1	Magnet
8	1	Left Handlebar	56	1	Spring
9	1	Right Handlebar	57	1	Idler
10	2	Handlebar Endcap	58	1	Flywheel Pulley
11	2	Handlebar Leg	59	1	Clamp
12	1	Left Roller Leg	60	2	Inner Bearing Set
13	1	Left Pedal	61	1	Motor
14	1	Left Pedal Leg	62	1	Resistance Cable Pulley
15	1	Right Pedal	63	1	Resistance Cable Set
16	1	Right Pedal Leg	64	2	Foam Grip
17	2	Frame Cover	65	1	Pivot Axle
18	2	Inner Handlebar Cover	66	2	Hub Cover
19	2	Outer Handlebar Cover	67	1	Stop Screw
20	2	Axle Bearing	68	1	Idler Screw
21	1	Right Roller Leg	69	1	M8 Flange Screw
22	2	Roller	70	4	M8 x 35mm Screw
23	2	Stabilizer Endcap	71	4	M8 x 42mm Bolt
24	2	Roller Axle	72	2	M8 Split Washer
25	2	Wheel	73	4	M4 x 12mm Flange Screw
26	4	Foot	74	8	M8 x 25mm Screw
27	4	Wheel Bearing	75	2	3/8" Flange Screw
28	1	Left Side Shield	76	2	M10 Spacer
29	1	Right Side Shield	77	2	Pivot Bushing
30	2	Crank Axle Cap	78	2	M8 x 48mm Button Screw
31	4	Axle Cap	79	18	M4 x 16mm Self-tapping Screw
32	4	Pedal Leg Axle	80	8	M10 x 23mm Shoulder Screw
33	8	Axle Bushing	81	2	M10 x 20mm x 1mm Washer
34	4	Roller Bushing	82	4	M8 x 16mm Patch Screw
35	1	Front Stabilizer	83	4	M8 x 25mm Washer
36	2	Crank Arm	84	2	M10 x 20mm x 1.5mm Washer
37	1	Convenience Tray	85	10	M4 x 12mm Screw
38	2	Crank Hub	86	6	M4 x 16mm Screw
39	1	Pulley Spacer	87	8	M6 x 35mm Phillips Screw
40	1	Pulley	88	8	M6 Split Washer
41	12	Axle Bushing	89	4	M10 x 62mm Bolt
42	2	Pedal Leg Endcap	90	2	M10 x 78mm Button Screw
43	1	Crank Sleeve	91	4	M10 x 20mm Button Screw
44	2	Crank Bearing Set	92	4	M10 x 20mm x 2mm Washer
45	1	Crank	93	2	M4 x 13mm Washer
46	8	Round Inner Cap	94	4	M10 x 25mm Washer
47	4	Snap Ring	95	3	M8 x 16mm Button Screw
48	1	Wire Harness	96	6	M8 Nylon Locknut



Key No.	Qty.	Description	Key No.	Qty.	Description
97	2	M10 Nylon Locknut	#	3	Hex Key
98	8	Wave Washer	#	1	Grease
99	1	M4 x 12mm Screw	#	1	User's Manual
100	3	Star Washer			

Note: “#” indicates a non-illustrated part. Specifications are subject to change without notice. See the back cover of this manual for information about ordering replacement parts.

# EXPLODED DRAWING A—Model No. PFEL8947.0

R0906B

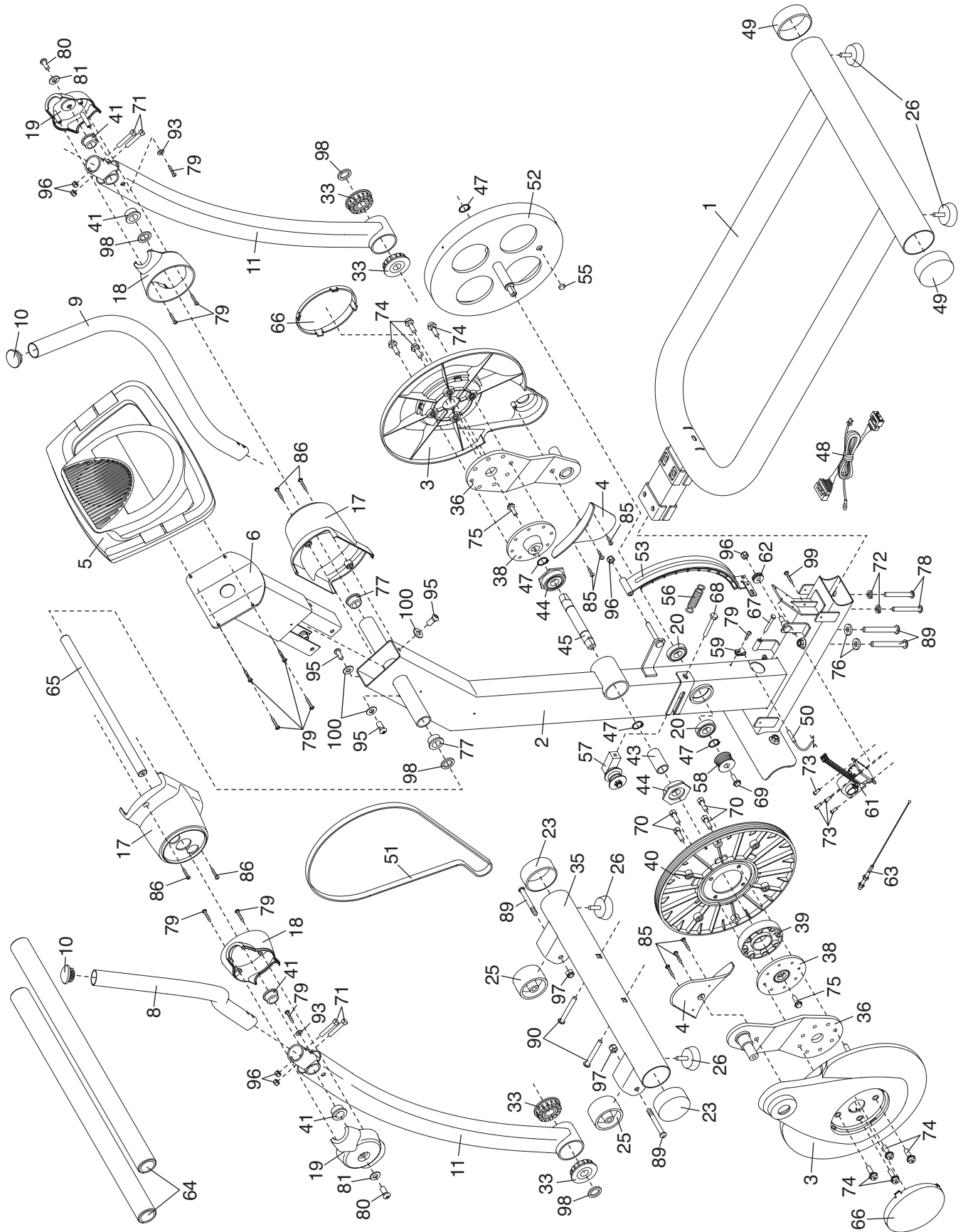

# EXPLODED DRAWING B—Model No. PFEL8947.0

R0906B

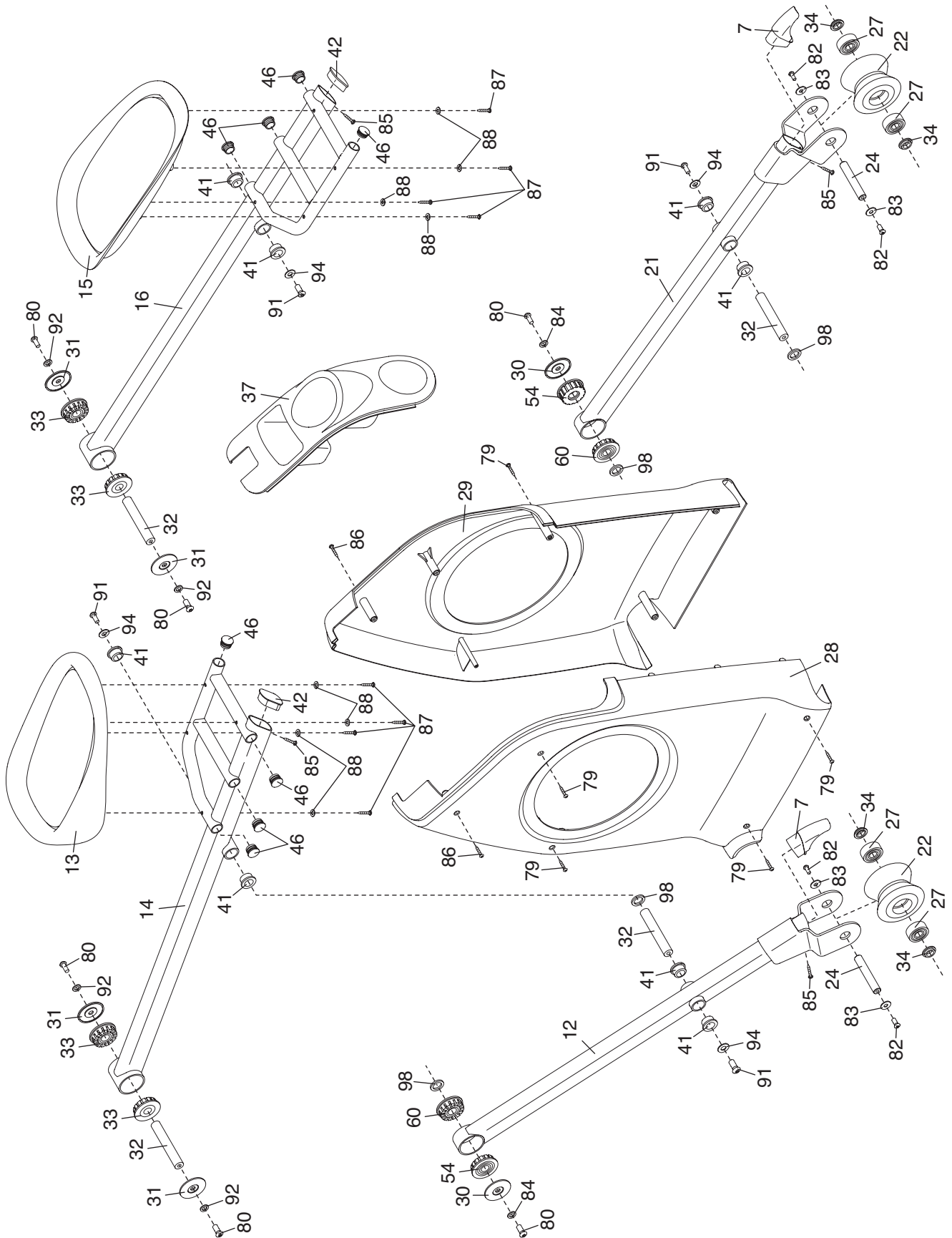

# HOW TO ORDER REPLACEMENT PARTS

To order replacement parts, please see the front cover of this manual. To help us assist you, please be prepared to give the following information when contacting us:

- the MODEL NUMBER of the product (PFEL8947.0)
- the NAME of the product (PROFORM 160 elliptical exerciser)
- the SERIAL NUMBER of the product (see the front cover of this manual)
- the KEY NUMBER and DESCRIPTION of the part(s) (see pages 24 to 27)

## LIMITED WARRANTY

ICON Health & Fitness, Inc. (ICON) warrants this product to be free from defects in workmanship and material, under normal use and service conditions, for a period of ninety (90) days from the date of purchase. This warranty extends only to the original purchaser. ICON's obligation under this warranty is limited to replacing or repairing, at ICON's option, the product through one of its authorized service centers. All repairs for which warranty claims are made must be pre-authorized by ICON. If the product is shipped to a service center, freight charges to and from the service center will be the customer's responsibility. For in-home service, the customer will be responsible for a minimal trip charge. This warranty does not extend to any product or damage to a product caused by or attributable to freight damage, abuse, misuse, improper or abnormal usage or repairs not provided by an ICON authorized service center; products used for commercial or rental purposes; or products used as store display models. No other warranty beyond that specifically set forth above is authorized by ICON.

ICON is not responsible or liable for indirect, special or consequential damages arising out of or in connection with the use or performance of the product or damages with respect to any economic loss, loss of property, loss of revenues or profits, loss of enjoyment or use, costs of removal or installation or other consequential damages of whatsoever nature. Some states do not allow the exclusion or limitation of incidental or consequential damages. Accordingly, the above limitation may not apply to you.

The warranty extended hereunder is in lieu of any and all other warranties and any implied warranties of merchantability or fitness for a particular purpose is limited in its scope and duration to the terms set forth herein. Some states do not allow limitations on how long an implied warranty lasts. Accordingly, the above limitation may not apply to you.

This warranty gives you specific legal rights. You may also have other rights which vary from state to state.

**ICON HEALTH & FITNESS, INC., 1500 S. 1000 W., LOGAN, UT 84321-9813**

## Free Manuals Download Website

<http://myh66.com>

<http://usermanuals.us>

<http://www.somanuals.com>

<http://www.4manuals.cc>

<http://www.manual-lib.com>

<http://www.404manual.com>

<http://www.luxmanual.com>

<http://aubethermostatmanual.com>

Golf course search by state

<http://golfingnear.com>

Email search by domain

<http://emailbydomain.com>

Auto manuals search

<http://auto.somanuals.com>

TV manuals search

<http://tv.somanuals.com>