

UT-PRO 410

Hanging the TV

PRO MOUNTS

Caution: PROMOUNTS strongly recommends that there is a minimum of two people present to perform this next step.

Hang the TV onto the wall plate:

- After securing the V-Bars to the back of the television and the wall plate to the wall, you can now hang the television.
- Carefully pick-up the television and engage the hooks on the V-Bar with the top and bottom horizontal projections on the wall plate.
- Please note that the V-Bars have two separate positions to engage the wall plate. See diagram below. Remember to allow long enough video and power cables to allow for vertical and horizontal adjustment.
- Once the final position is determined, secure the unit with the L-shaped Locking Bars provided. Slide them horizontally through the slot located below the hooks on the V-Bars.
- The Locking Bars should always be used to guard against seismic damage. A padlock can be added for additional security.

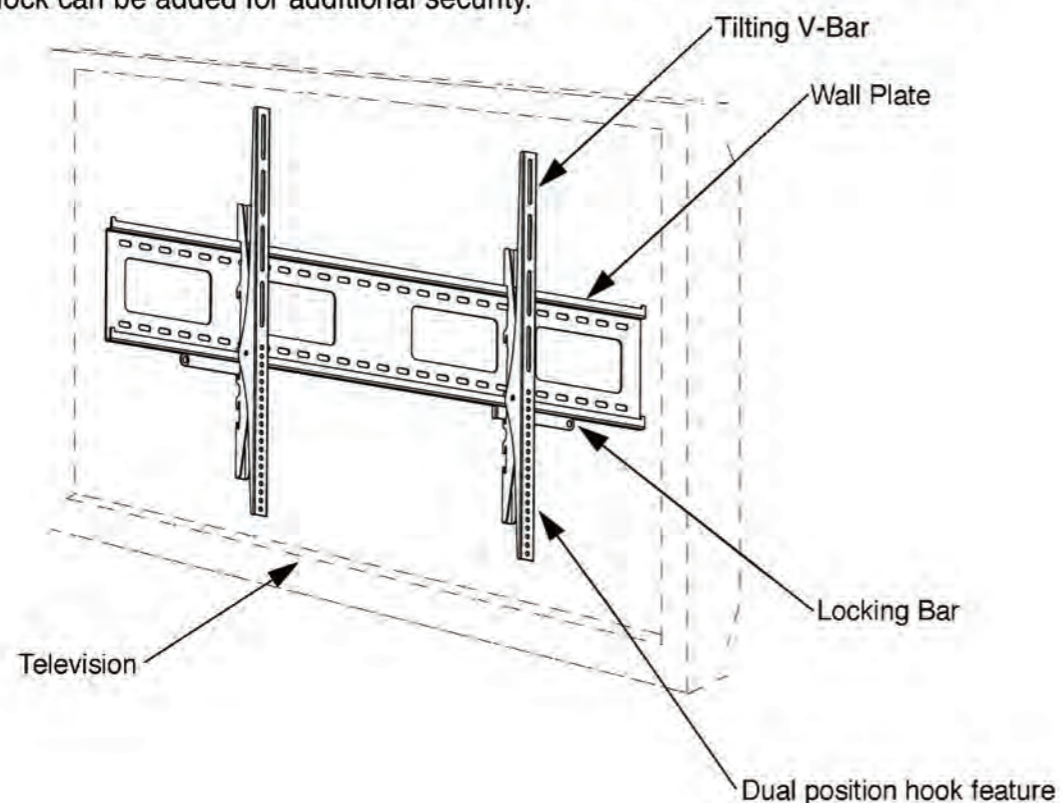

Thank you for choosing PROMOUNTS
 Visit our website for more fine products
www.promounts.com

UT-PRO 410

Installation Guide

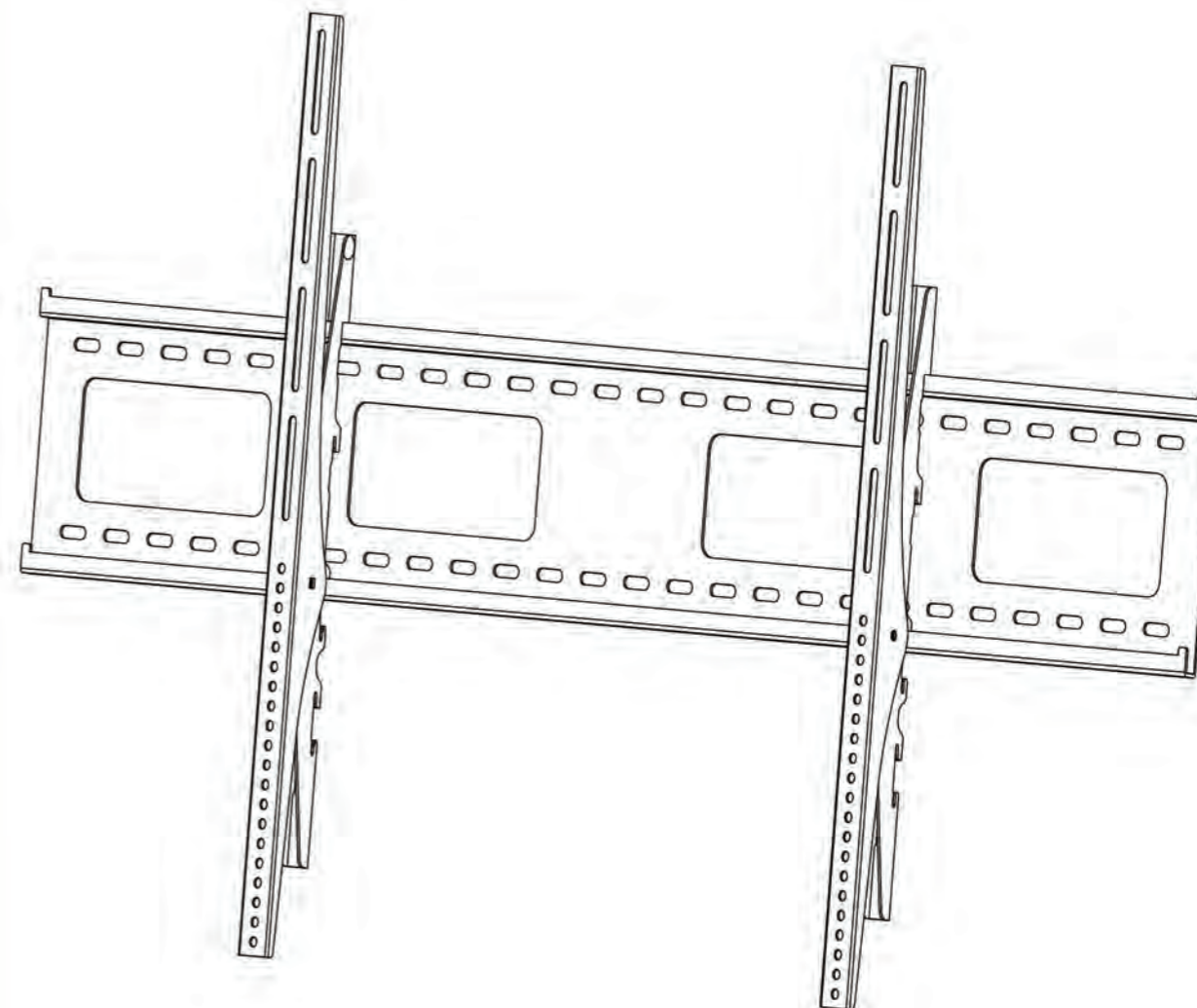
PRO MOUNTS

UNIVERSAL TILTING PLASMA MOUNT

Patent Pending © Promounts 2007

UT-PRO 410

Important Information

PRO MOUNTS

UT-PRO410

Tilt Wall Mount

This product is designed to mount flat panel plasma and LCD televisions weighing up to 400 lb. to a vertical wall. The new design allows a flat mounting on the wall with less than 1.22" distance between the wall and the display.

SAFETY WARNING: If you don't understand these directions, or have doubts about the installation, please call a qualified contractor or contact PROMOUNTS at 866-MOUNTS2 or www.promounts.com.

We can quickly assist you with installation questions and missing or damaged parts. Replacement parts for products purchased through authorized dealers will be shipped directly to you. Check carefully to make sure there are no missing or defective parts. Improper installation may cause damage or serious injury. Do not use this product for any purpose that is not explicitly specified by PROMOUNTS or the manufacturer. Neither PROMOUNTS nor the manufacturer can be liable for damage or injury caused by incorrect assembly, incorrect mounting, or incorrect use.

Required Tools: Electric hand drill, Phillips screwdriver, 1/4" drill bit, 1/2" Masonary drill bit (for brick, concrete or concrete block installations), level, electronic stud sensor, combination wrenches or socket set.

All hardware is supplied for the following wall conditions: Wood stud, brick, solid concrete and concrete block. PROMOUNTS makes every effort to assure all necessary television mounting hardware is included in this kit. If the hardware you need is not included please contact your local hardware store or contact PROMOUNTS.

Note: The supplied hardware is **not for steel stud walls**. If you are uncertain about the nature of your wall, consult an installation contractor.

This document contains instructions to mount a plasma TV or LCD using a UT-PRO wall mount system. Please read the documentation provided carefully prior to installation.

UT-PRO 410

Attaching the V-Bars

PRO MOUNTS

Warning: Do not lay the television face down on the glass, lean it up against a wall or other solid surface. Laying the television on the glass may cause permanent damage.



Caution: Always make sure the television is unplugged before threading any bolt or screw into the back panel.

Selecting the correct hardware:



Thread screws carefully into your television by hand before tightening. If you any feel resistance, remove the bolt immediately!

- Locate the threaded inserts on the back panel of your television and determine which screw is the correct diameter. Thread the screw carefully into the inserts by hand until you find the diameter that correctly fits.
- Next, determine the correct length of the required screw. Televisions with flat backs will use one of the shorter screws without a spacer. Televisions with curved backs or recessed threaded inserts may rerequire a longer screw with a spacer between the television and the V-Bar.
- Now that you have the correct screw and spacer picked out, you are ready to attach the V-Bars to your television. If you are using any of the smaller screws, you will need to use the square washers as shown in the diagram below.

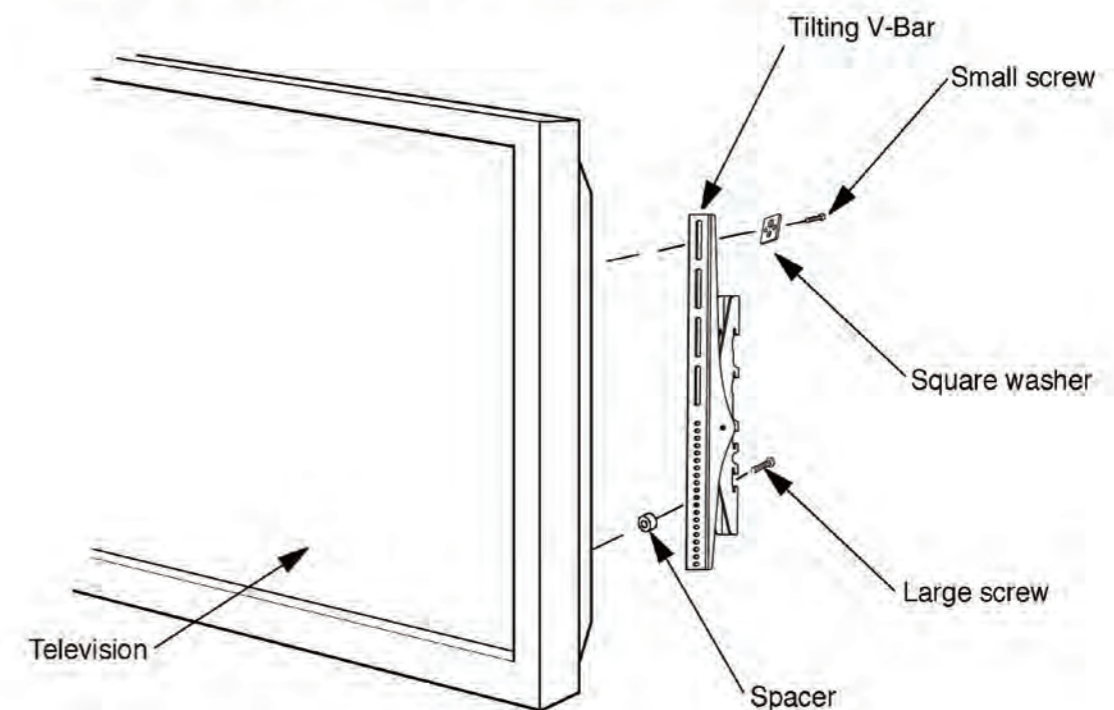

Warning

Tighten screws only until the V-Bar is pulled firmly against the television.
DO NOT OVER TIGHTEN THE SCREWS

UT-PRO 410

Installing the Wall Plate

PRO MOUNTS

Wood Stud Mounting:

The wall plate must be mounted to three wood studs at least 16" apart. Use a high quality electronic stud sensor to locate two adjacent studs. It is a good idea to verify the stud center with an awl or thin nail.

- Position the wall plate in the desired mounting over the studs. Making sure the wall plate is level, use the small horizontal slots as a template and mark hole locations over the studs.
- Use a 1/4" bit and pre-drill a 3.5" deep hole into the wall and stud. Repeat 5 times.
- Attach the wall plate to the wall using the lag bolts and Ø10 washers as shown below. Make sure flat center of the plate is against the wall.

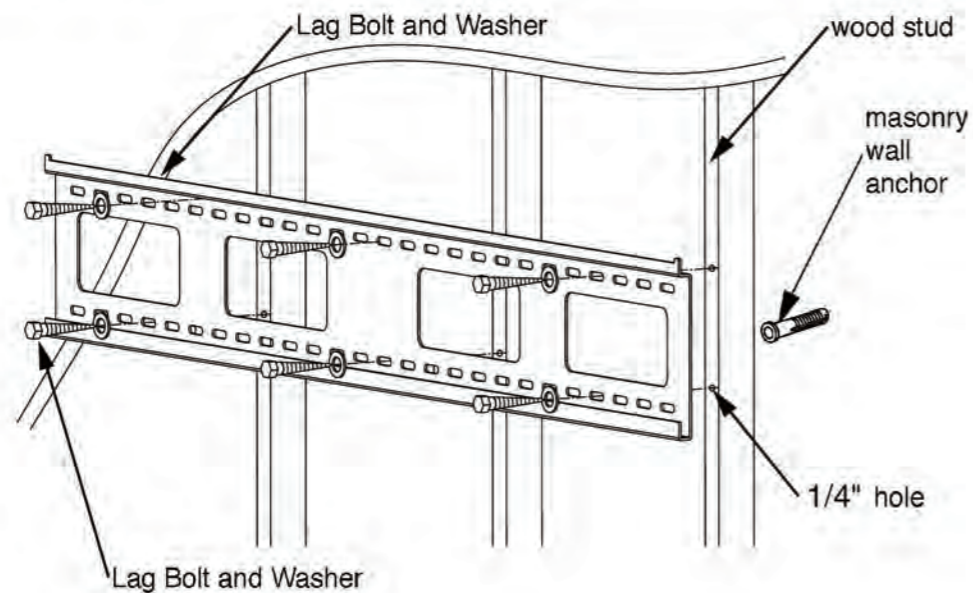

Concrete (Masonry) Mounting:

The wall plate must be mounted to the wall with 6 lag bolts.

- Position the wall plate in the desired mounting on the wall. Making sure the wall plate is level, use the small horizontal slots as a template and mark hole locations on the wall.
- Use a 1/2" masonry bit and pre-drill a 3.5" deep hole into the wall. Repeat 5 times.
- Install the supplied plastic anchors in each hole. Tap into the hole until fully seated.
- Attach the wall plate to the wall using the lag bolts and Ø10 washers as shown above. Make sure flat center of the plate is against the wall.

Warning

**Tighten lag bolts only until the washer is pulled firmly against the wall plate.
DO NOT OVER TIGHTEN THE LAG BOLTS**



**Caution: Wall anchors should only be used for masonry mounting.
NEVER use wall anchors to mount the UF-PRO to drywall.**

UT-PRO 410

Specifications & Notes

PRO MOUNTS

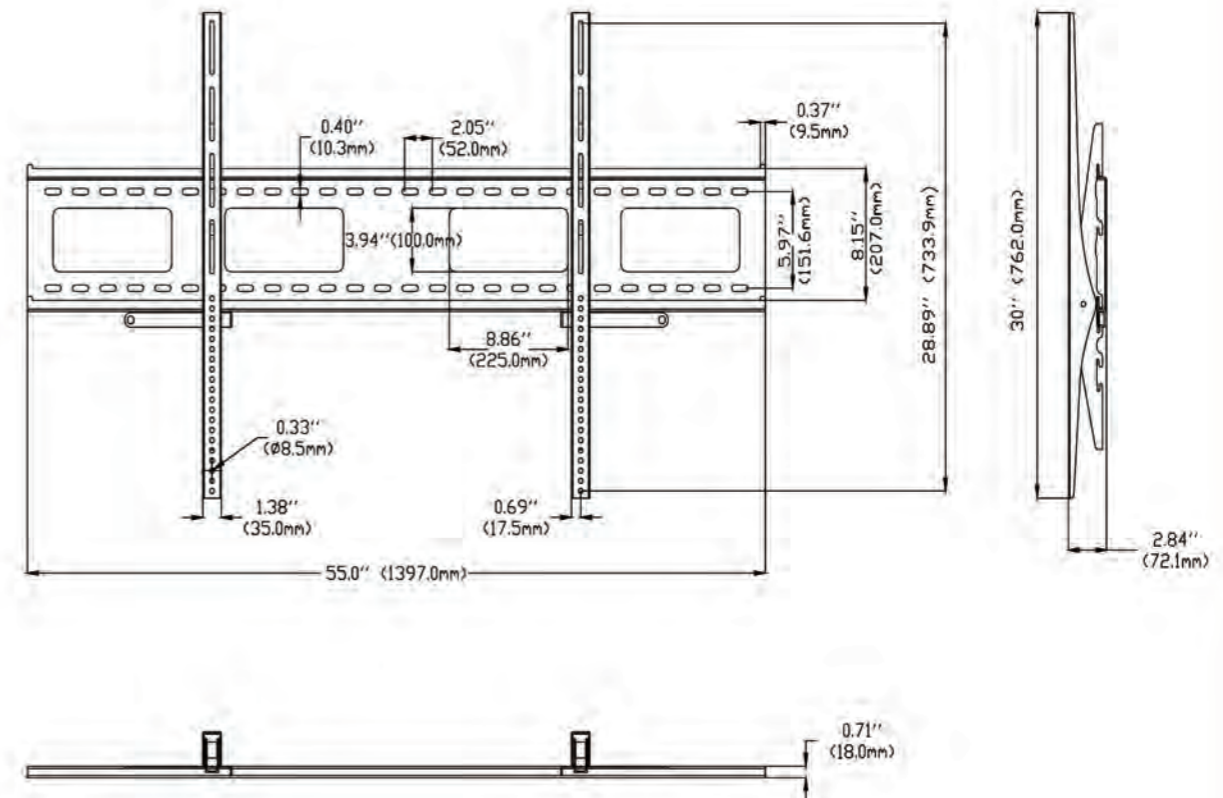

Due to the high weight capacity of the UT-PRO410, make sure the wall can withstand the weight of screen, the mount, as well as any other components to be mounted on the wall. It is the responsibility of the installer to check the integrity of the wall. Many wall structures are not designed to hold weights of this magnitude.

 This symbol indicates required action.

 This symbol indicates forbidden action.

 This symbol indicates caution.

All rights reserved. Unauthorized copying or reproduction is prohibited

UT-PRO 410

Package Contents

PRO MOUNTS

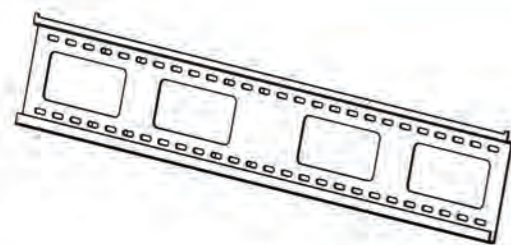

Plasma Wall Plate.....1 pcs.



Tilt V-Bar1 pair

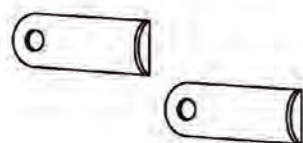

L-Shaped Locking Bar.....2 pcs.

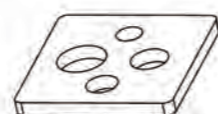

Square Washer.....4 pcs.



Spacer 1.....4 pcs.



Spacer 2.....4 pcs.



Ø10 Washer.....6 pcs.

Truss Head Screws

- M4x10/M4x15/M4x35/M4x45.....4 pcs. each
- M5x10/M5x15/M5x35/M5x45.....4 pcs. each
- M6x10/M6x15/M6x35/M6x45.....4 pcs. each
- M8x10/M8x15/M8x35/M8x45.....4 pcs. each



Concrete Anchor.....6 pcs.







Lag Bolts.....6 pcs

UT-PRO 410

Cautions and Warnings

PRO MOUNTS

-  Do not install on a sloping surface. Install only on a vertical surface.
-  Do not install in a room where temperature and humidity are excessively high.
-  Do not install near an air conditioner.
-  Do not install in a location where there is excessive dust, smoke or moisture as these sources could create a fire.
-  To prevent eye fatigue, do not install where there is direct sunlight or strong light.
-  It is strongly recommended that at least two people carry out the installation.
-  Do not apply unnecessary stress or load on the installed unit.
-  When carrying out maintenance, disconnect the power supply to avoid electrical shock.

Free Manuals Download Website

<http://myh66.com>

<http://usermanuals.us>

<http://www.somanuals.com>

<http://www.4manuals.cc>

<http://www.manual-lib.com>

<http://www.404manual.com>

<http://www.luxmanual.com>

<http://aubethermostatmanual.com>

Golf course search by state

<http://golfingnear.com>

Email search by domain

<http://emailbydomain.com>

Auto manuals search

<http://auto.somanuals.com>

TV manuals search

<http://tv.somanuals.com>