

OPERATING INSTRUCTIONS

PROSCAN

24" LCD TV
PLCD2401A

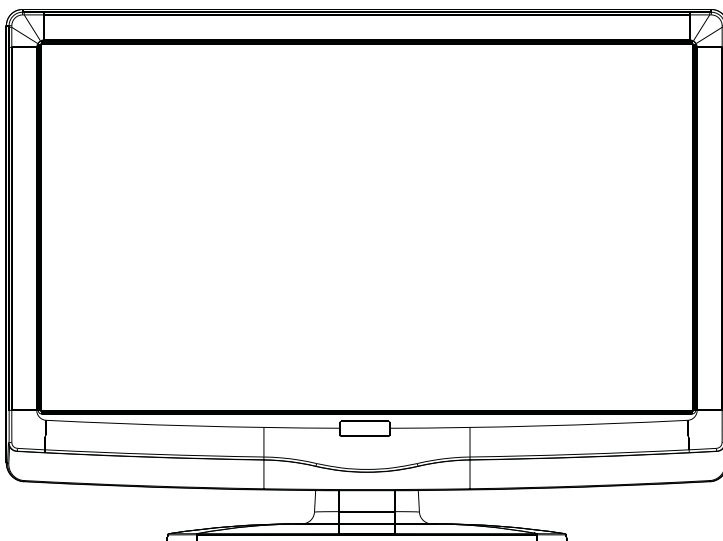

ENERGY
PERFORMANCE
VERIFIED

RENDEMENT
ENERGETIQUE
VERIFIE

Contents

Safety and warnings.....	2-3
Introduction.....	4
Wall Mount.....	5
Installation.....	6-9
Remote Control.....	10
Operation.....	11-13
Trouble Shooting.....	14

IMPORTANT SAFETY INSTRUCTION

ENERGY STAR is a joint program of the U.S. Environmental Protection Agency and the U.S. Department of Energy helping us all save money and protect the environment through energy efficient practices.

- 1) Read these instructions.
- 2) Keep these instructions.
- 3) Heed all warnings.
- 4) Follow all instructions.
- 5) Do not use this Television near water.
- 6) Clean only with dry cloth.
- 7) Do not block any ventilation openings, install in accordance with the instructions.
- 8) Do not install near any heat sources such as radiations, heat registers, stoves, or other Television (including amplifiers) that produce heat.
- 9) Do not defeat the safety purpose of the polarized plug. If the provided plug does not fit into your outlet, consult an electrician for replacement of the obsolete outlet.
- 10) Protected the power cord from being walked on or pinched particularly at plugs, convenience receptacles, and the point where they exit from the Television.
- 11) Only use attachments/accessories specified by the manufacturer.
- 12) Unplug this Television during lightning storms or when unused for long periods of time.
- 13) Refer all servicing to qualified service personnel. Servicing is required when the Television has been damaged in any way, such as; power-supply cord or plug is damaged, liquid has been spilled or objects have fallen into the Television, the Television has been exposed to rain or moisture, does not operate normally, or has been dropped.
- 14) Mains plug is used as the disconnect device, the disconnect device shall remain readily operable.
- 15) The ventilation should not be impeded by covering the ventilation openings with items, such as newspapers, table-cloth, curtains, etc.
- 16) No naked flame sources, such as lighted candles, should be placed on the Television.
- 17) Attention should be drawn to the environmental aspects of battery disposal.
- 18) The use of Television in moderate climate.
- 19) The Television shall not be exposed to dripping or splashing and that no objects filled with liquids, such as vases, shall be placed on the Television.

<div style="display: inline-block; border: 1px solid black; padding: 2px; text-align: center; font-size: 8px;"> CAUTION RISK OF ELECTRIC SHOCK DO NOT OPEN! </div>
<p>CAUTION</p> <p>TO REDUCE THE RISK OF ELECTRIC SHOCK, DO NOT REMOVE COVER (OR BACK). NO USER SERVICEABLE PARTS INSIDE. REFER SERVICING TO QUALIFIED SERVICE PERSONNEL.</p>

The symbol indicates that dangerous voltages constituting a risk of electric shock are present within this unit.

The symbol indicates that there are important operating and maintenance instructions in the literature accompanying this unit.

<p>WARNING:</p> <p>To reduce the risk of fire or electric shock, do not expose this Television to rain or moisture.</p>
--

<p>WARNING:</p> <p>The batteries shall not be exposed to excessive heat such as sunshine, fire or the like.</p>
--

<p>WARNING:</p> <p>The excessive sound pressure from earphones and headphones can cause hearing loss.</p>
--



This symbol indicates that this product incorporates double insulation between hazardous mains voltage and user accessible parts. When servicing use only identical replacement parts.



This marking indicates that this product should not be disposed with other household wastes throughout the EU. To prevent possible harm to the environment or human health from uncontrolled waste disposal, recycle it responsibly to promote the sustainable reuse of material resources. To return your used device, please use the return and collection systems or contact the retailer where the product was purchased. They can take this product for environmental safe recycling.

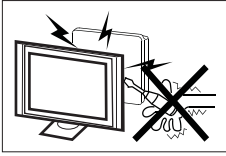

High voltages are used in the operation of this television receiver. Do not open the cabinet. Refer servicing to qualified service personnel.

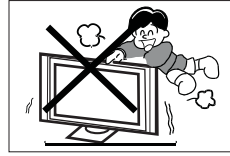

Never stand on, lean on, or suddenly push the television or its stand. You should pay special attention to children. Serious injury may result if it falls.

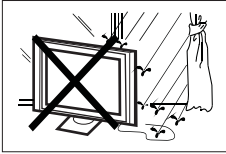

To prevent fire or electrical shock hazard, do not expose the television receiver to rain or moisture.

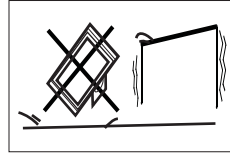

Do not place your television on an unstable cart, stand, shelf or table. Serious injury to an individual and/or damage to the television may result if it falls.

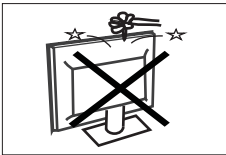

Do not drop or push objects into the television cabinet slots or openings. Never spill any kind of liquid on the television receiver.

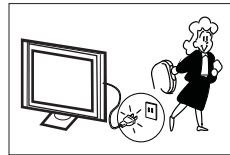

When the television receiver is not used for an extended period of time, it is advisable to disconnect the AC power cord from the AC outlet.

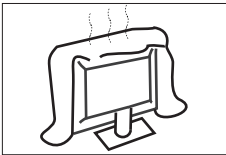

Do not block the ventilation holes on the back cover of the TV. Adequate ventilation is essential to prevent failure of electrical components.

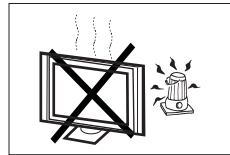

Avoid exposing the television receiver to direct sunlight and other sources of heat. Do not stand the television receiver directly on other products which give off heat, e.g. video cassette players and audio amplifiers. Do not place naked flame sources, such as lighted candles on or near the television.

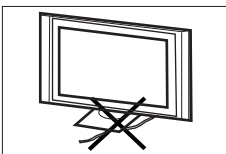

Do not trap the power supply cord under the television receiver's stand.

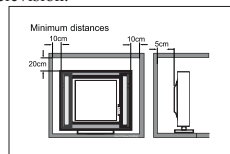

If the television is to be built into a compartment or similar enclosure, the minimum distances must be maintained. Heat build-up can reduce the life of your television, and can also be dangerous.

Main features

- Integrated ATSC TV tuner for HDTV broadcast reception
- High brightness provides a vivid and brilliant picture
- High dynamic contrast ratio for deeper blacks and brighter whites
- Wide Screen aspect ratio (16:9) for a complete home theater experience
- HDMI input for true digital connection
- VGA port for connection to PC
- Integrated Built-in stereo speaker system
- Full-function remote control

This product default mode (standard mode) already pass the Energy star test. If TV set in other mode, may increase energy consumption beyond the limits required for ENERGY STAR qualification.

Accessories

Infrared Remote Control.....	1
User's Manual	1
Battery(AAA).....	2

Main parameter

Viewing Picture Size (diagonal)	24 inches
Resolution:	1366x768
Power consumption:	60W
Audio Output Power (THD ≤ 7%):	2x3W
Input Power Voltage:	AC 100-240V 50/60Hz
Aspect Ratio:	16:9
TV System:	ATSC Digital system and NTSC Analog system
Video Signal System:	NTSC
Receiving Channel:	Cable :1-135/ Air: 2-69 (ATV&DTV)
High-Definition Multimedia Interface (HDMI) Input	x 2
YCb(Pb)Cr(Pr) Input	x 1
Composite Video Input	x 1
Analog RGB (VGA) Input	x 1
Audio Input	x 2
Headphone Output	x 1
Coaxial Output	x 1
USB Input	x 1
Horizontal definition (TV line)	Composite Video Input ≥350 Video Input ≥400 YCb(Pb)Cr(Pr) ≥400

Instruction for Wall Mount

A wall mount kit (purchased separately) would allow you to mount your PROSCAN TV on the wall. For detailed information on installing the wall mount, refer to the instructions provided by the wall mount manufacturer. It is strongly recommended to contact a technician for professional assistance for wall mount installation.

Dimensions for Mounting Hole Pattern

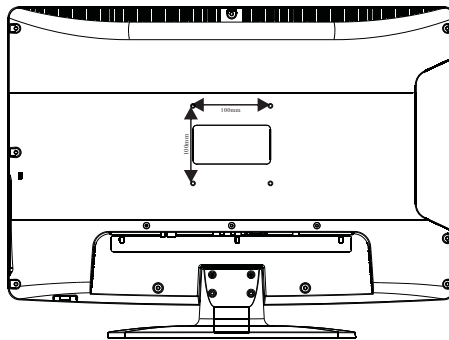

- This PROSCAN TV is compatible with a 100mm x 100mm mounting hole pattern.
- 4 pcs of type M4 screws are required for installing the wall mount bracket to your PROSCAN TV. Do not use screws that are longer than 10 mm. Screws that are too long may cause damage to the inside of the TV set.
- Do not fasten the screws too tight for this may damage the TV or cause the TV to fall, resulting in personal injury. PROSCAN is not liable for these kinds of incidents.
- Do not mount your PROSCAN TV at more than a 15 degree tilt.
- Always use two people to mount the TV to a wall.
- Do not install your Wall Mount Kit while your TV is turned on. It may result in personal injury due to electric shock.

Front panel

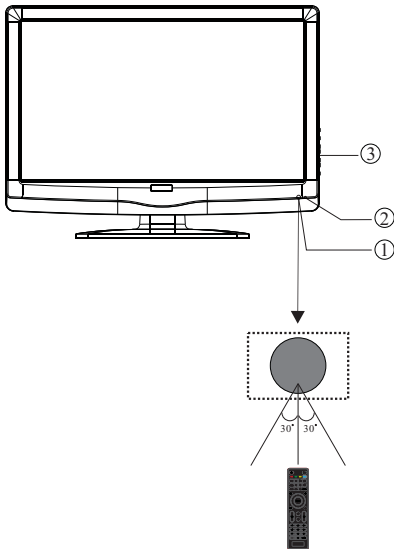

- 1: Remote control sensor.
- 2: Indicator LED: GREEN ● POWER ON.
RED ● STANDBY.
- 3: Panel keys

Panel keys

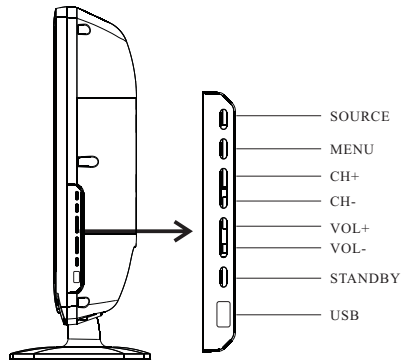

- 1. **SOURCE**: Display the input source menu.
- 2. **MENU**: Display main MENU.
- 3. **CH+/CH-**: In TV mode, press "CH+" or "CH-" to change the channel up and down. In MENU mode, press "CH+" or "CH-" to select items in standby mode, press "CH+" or "CH-" to turn on the TV.
- 4. **VOL+/VOL-**: Adjust sound level. In MENU mode, press "VOL+" or "VOL-" to adjust the item that you selected.
- 5. **STANDBY**: Press this button to turn the unit ON from STANDBY mode. Press it again to turn the set back to STANDBY.
- 6. **USB**

REAR Connections

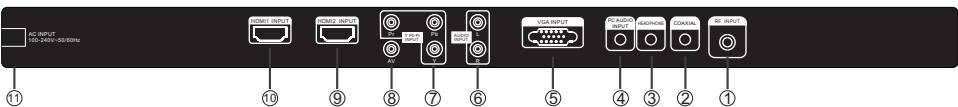

- 1. Antenna Socket
- 2. Coaxial
- 3. Headphone Output
- 4. PC Audio Input
- 5. VGA Port (PC Input)
- 6. Audio Input
- 7. Component Video (YPbPr) Input
- 8. Composite Video Input
- 9. HDMI2 Input
- 10. HDMI1 Input
- 11. AC Power Socket

Note: When HDMI has an input signal coming from a DVI source then the audio input signal must be connected to the PC audio input.

PC

STEPS:

It is recommended that the TV and computer are off before making any of the connections.

1. Connect a VGA and audio cable.
2. Connect the power cord.
3. Turn on the TV and switch to VGA mode.
4. Turn on the PC.

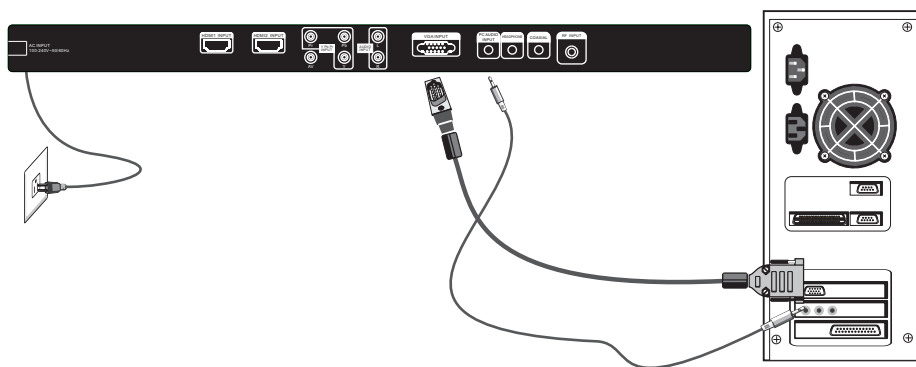

PRESET MODE

	RESOLUTION	V.Freq.(Hz)	H.Freq.(KHz)
1	720*400	70	31.47
2	640*480	60	31.47
3	640*480	75	37.50
4	800*600	60	37.88
5	800*600	75	46.88
6	1024*768	60	48.36
7	1024*768	70	56.48
8	1024*768	75	60.02
9	1280*1024	60	63.98
10	1280*1024	75	80.00

ANTENNA

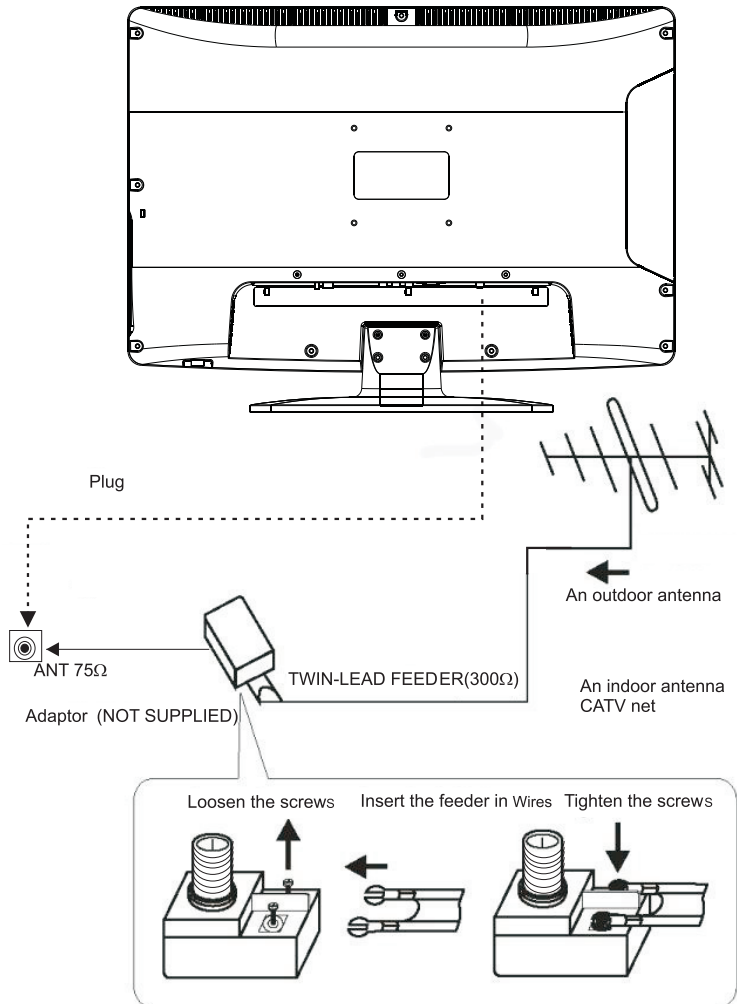

Note:
 Aerial connections: IEC (female).
 Input impedance: 75 Ω unbalanced.

AV EQUIPMENT

There are two HDMI ports located on the back of your TV. You can connect a Blu-ray player, DVD player, or other video equipment through these ports.

There is one component (Y, Pb, Pr) and one composite (AV) video input located on the back of your TV. You can connect a VCR, cable box, or other video equipment to these jacks.

Please see the diagram below. You may also need to refer to the owner's manual of the device that you are trying to connect.

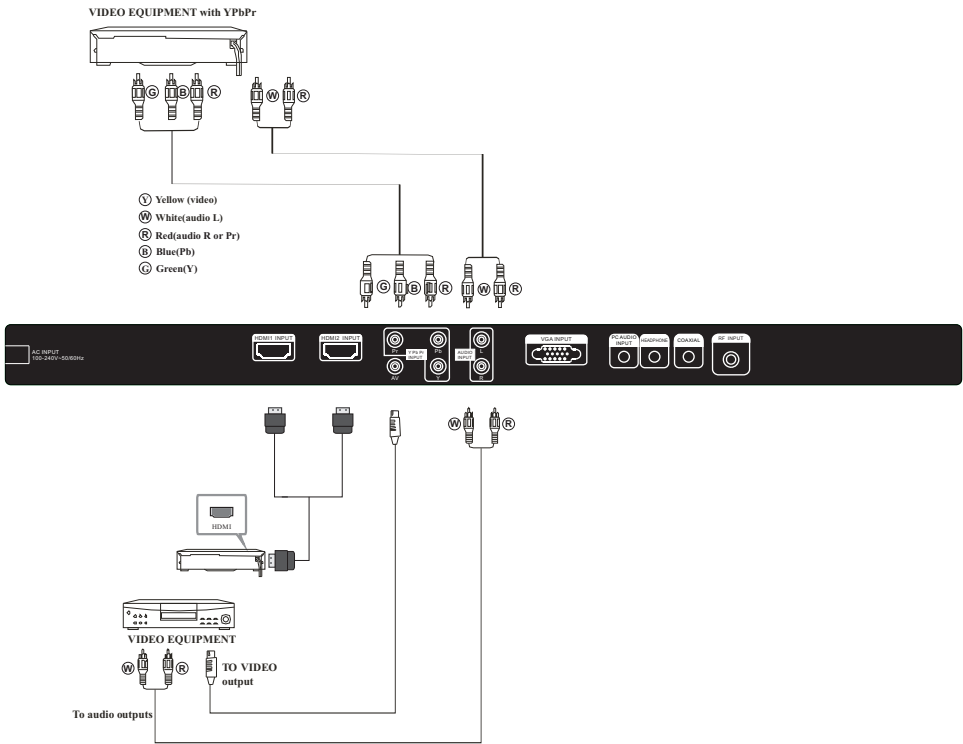

The television's inputs can be connected to the following types of equipment: VCR, DVD player, camcorder, video game or stereo system, etc.....

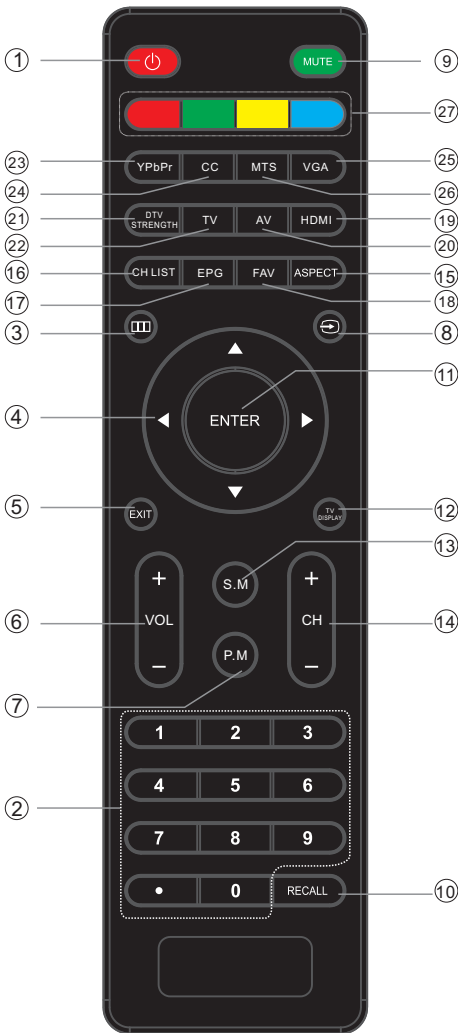

- 1: **POWER**
Press to turn the TV on or to turn off (standby).
- 2: **NUMBER KEY**
Press to input the channel number.
- 3: **□□□**
Press to display the on-screen menu.
- 4: **CURSOR**
Use the up, down, left, and right keys to move within the menu.
- 5: **EXIT**
Press to exit the on-screen menu.
- 6: **VOL+/-**
Press to adjust the sound level.
- 7: **P.M**
Press repeatedly to select a picture mode: Vivid, Standard, Sports, Movie, or Custom.
- 8: **↔**
Press to display and select the available video sources.
- 9: **MUTE**
Press to disable or enable the sound.
- 10: **RECALL**
Press to change to the previously viewed channel.
- 11: **ENTER**
Press to confirm the selection.
- 12: **TV DISPLAY**
Press to display/hide the program information.
- 13: **S.M**
Press repeatedly to switch audio modes: Standard, News, Music, Theater, Sports or Custom.
- 14: **CH+/CH-**
Press to change the channel.
- 15: **ASPECT**
Press to change the picture aspect ratio: Normal, Wide, Zoom, Cinema.
- 16: **CH LIST**
Press to display the channel list.
- 17: **EPG**
Press to display the channel guide.
- 18: **FAV**
Press to access the favorite channels list.
- 19: **HDMI**
Press to directly switch to HDMI mode.
- 20: **AV**
Press to directly switch to AV mode.
- 21: **DTV STRENGTH**
Press to display the digital TV signal strength.
- 22: **TV**
Press to directly switch to TV mode.
- 23: **YPbPr**
Press to directly switch to Component (YPbPr) mode.
- 24: **CC**
Press to enable/disable the closed captions.
- 25: **VGA**
Press to directly switch to VGA (PC input) mode.
- 26: **MTS**
Press to change the audio language, if available.
- 27: **COLOR KEYS**
Reserved keys

Universal Remote Code: 0X0707

1. PICTURE MENU

In this menu, you can adjust the picture effect here, such as contrast, brightness, etc. Press ▼▲ to select, press OK to adjust.

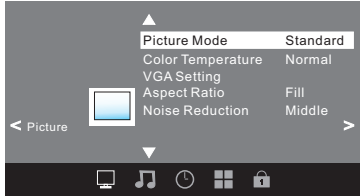

Note:

- 1). If you want to adjust contrast, brightness, color, and sharpness, the picture mode must return to personal status. Standard mode is the default setting, if you select some other options, the power consumption may change.
- 2). Tint is available in NTSC system only.
- 3). There are three color temperature modes can be selected: Normal, Warm and Cool.

1.1 VGA Setting

When PC Mode is available.

Press OK button to select PC advanced setting

- 1). H-Pos: Adjust the horizontal position of the screen.
- 2). V-Pos: Adjust the vertical position of the screen.
- 3). Clock: Fine tune the screen width.
- 4). Phase: Fine tune the phase of the screen. Usually don't adjust this item.
- 5). Auto: Auto adjust to fit the screen.

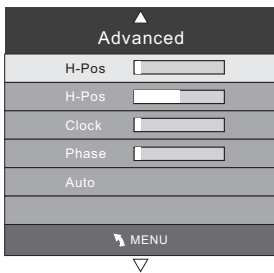

2. AUDIO menu

In this menu, you can adjust the sound effect here. Press ▼▲ to select, press OK to adjust.

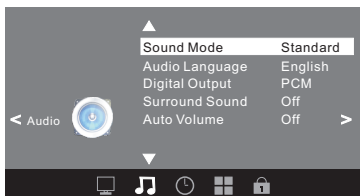

Note:

- 1). Audio language is available in ATSC/TV Programming only.
- 2). Auto volume is available only when the input signal volume is too large or there is distortion.

3. TIMER MENU

In this menu, you can adjust the sleep timer, time zone, etc. Press ▼▲ to select, press OK to adjust.

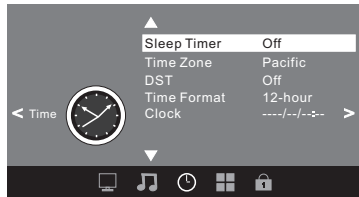

Note:

- 1). Time zone, DST and the clock are available in ATSC programming only, and the Clock can't be adjust.

4. OPTION menu

In this menu, you can adjust the Menu language, Close Caption, Restore Default etc. Press ▼▲ to select, press OK to adjust.

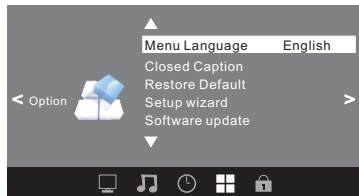

4.1 Closed Caption

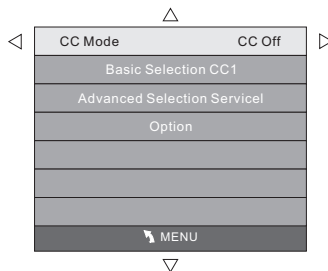

- 1).CC Mode: Switching close caption mode.
- 2). Advanced selection: only ATSC program is available.
- 3).Option: Used to edit CC font.

Note:

- 1).Restore Default: Restore Default will clear all the programs and reset all the settings to default value.

5.LOCK MENU

In this menu, you can change the password and adjust the vchip setting.

Enter the password, it will go into the lock menu. Factory default password is 6666.

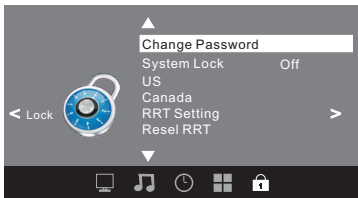

5.1 Change Password

- 1).Old password: Input the old password.
- 2).New password: Input the new password.
- 3).Confirm password: Input the new password again.

5.2 System Lock

When the System Lock switch is ON, the below options listed below can be adjusted.

5.3 US

Press OK button the screen will display as follow.

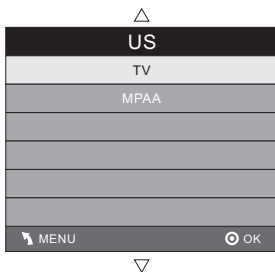

- 1).TV: Press OK button, the screen will display as follows:

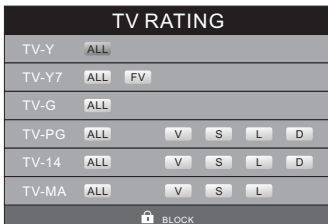

Rating	Content	Content				
		FV (Fantasy violence)	V (Violence)	S (Sexual situation)	L (Adult language)	D (Sexually suggestive dialog)
Suggested age	TV-Y (All children)					
	TV-Y7(Direct to order children)	X				
	TV-G(General audience)					
	TV-PG(Parental Guidance suggested)		X	X	X	X
	TV-14(Parents strongly cautioned)		X	X	X	X
	TV-MA(Mature audience only)		X	X	X	

And use the ENTER key to switch lock/ unlock Parental Control feature.

- 2).MPAA: Switching the movie-rating control level; N/A, G, PG, PG-13, R, NC-17, X.

Rating	Description	
Age	G	General audiences, All Ages admitted
	PG	Parental Guidance suggested. Some material may not be Suitable for children.
	PG-13	Parents strongly cautioned. Some material .may be Inappropriate for children under 13.
	R	Restrict. Under 17 requires accompanying parent or adult guardian(age varies in some jurisdictions)
	NC-17	No one 17 and under admitted.
	X	X is an order rating that is unified with NC-17 but may be encoded in the data of order movies.

5.4 Canada

Press OK button, the screen will be displayed as follow:



- 1): Canada English: Switching the English rating control level: EXEMPT, C, C8+, G, PG, 14+, 18+.

Rating	Description
E	Exempt: Includes news, sports, documents and other information programming: talk shows, music videos, and variety programming.
C	Children: Intended for younger children under the age of 8 years. Pays careful attention to themes that could threaten their sense of security and well-being.
C8+	Children over 8 years old: Contains no portrayal of violence as the preferred, acceptable, or only way to resolve conflict; nor encourage children to imitate dangerous acts which they may see on the screen.
G	General: Considered acceptable for all age groups, Appropriate viewing for the entire family, contains very little violence, physical, verbal or emotional.
PG	Parental Guidance: Intended for a general audience, but may not be suitable for younger children (under the age of 8) because it could contain controversial themes or issues.
14+	Over 14 Years: Could contain themes where violence is one of the dominant elements of the storyline But it must be integral to the development of plot or character. Language usage could be profane and nudity, present within the context of theme.
18+	Adults: Intended for viewers 18 years and older and might contain depictions of violence, which while related to the development of plot, character or themes, are intended for adult viewing. Could contain graphic language and portrayals of secretary and nudity.

2).Canada French: Switching the French-rating control level: E, G, 8ANS+, 13 ANS+, 16ANS+, 18ANS+.

Rating	Description
E	Exempt programming
G	General :All ages and children, contains minimal direct violence, but may be integrated into the plot in a humorous or unrealistic manner .
8ans+	General but inadvisable for young children :May be viewed by a wide public audience, but could contain scenes disturbing to children under 8 who cannot distinguish between imaginary and real situations. Recommended for viewing with paren.
13ans+	Over 13 years: Could contain scenes of frequent violent scenes and in tense violence.
16ans+	Over 16 years: Could contain frequent violent scenes and violence.
18ans+	Over 18 years: Only for adult viewing. Could contain frequent violent scenes and extreme violence.

5.5 RRT setting

in ATSC digital TV mode, it can be adjusted

5.6 Reset RRT:

Press OK button, the screen will be displayed as follow:

6. Channel MENU

In this menu, you can adjust digital and analog TV Channels.

Press ▼ to select,press OK to adjust.

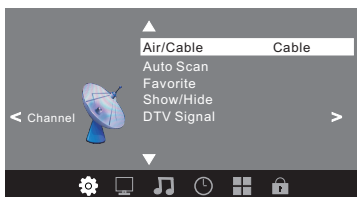

6.1 Air/Cable:

Select Air TV signal and cable TV signal.

6.2 Auto Scan:

If it's the first time you use the TV, you should scan all the TV channels first,

Press OK button to confirm, you will see the menu

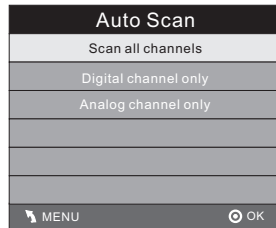

Press OK button to select a scan type,you will see the message below which indicates auto search is in process.

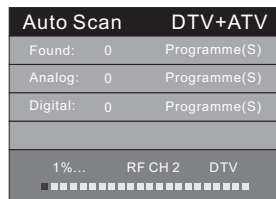

6.3 Favorite:

Press OK button to choose/delete the favorite channel.

6.4 Show/Hide

Press OK button to display or hide current channel.

6.5 DTV signal

Display DTV strength signal. It can't be selected and adjusted.











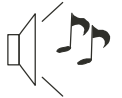

7. USB function

Before starting operation, verify that the USB storage device is using the FAT32 file system format. This television does not support NTFS or other formats. Please use a high-speed USB 2.0 device with a maximum capacity of 50GB.

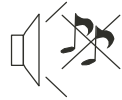
1). This USB has the function of picture playing.

Use ◀▶ select the .jpg files or folders, press ENTER to display the photo or open the folder, press EXIT to stop playing or go to the previous menu.

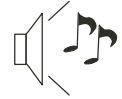
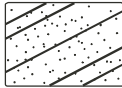
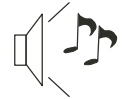
2). This USB also has the funtion of software updating for service purpose.

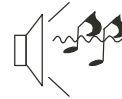
Trouble phenomenon Symptom		Inspection Check	
Picture	Audio		
 Snow	 Noise	antenna position, direction or connection	
 Ghost	 Normal audio	antenna position, direction or connection	
 Interference	 Noise	electronic equipment, car/ motorcycle, fluorescent light	
 Normal Picture	 Mute	Volume (check if mute is activated or if the audio system connections are not correct)	
 No picture	 Mute	Power cord is not inserted Power switch is not opened Contrast and brightness/volume setup Press standby key on the remote control for inspecting	
 No color	 Normal audio	Color control	
 Picture breaking up	 Normal audio or weak	Retune channel	
 No color	 Noise	TVsystem	

The LCD TV panel is built with very high precision technology giving you fine picture details in vibrant color. Occasionally, a few non-active pixels may appear on the screen as a fixed point of red, green, blue, black or white. Please note this does not affect the performance of the product.

Free Manuals Download Website

<http://myh66.com>

<http://usermanuals.us>

<http://www.somanuals.com>

<http://www.4manuals.cc>

<http://www.manual-lib.com>

<http://www.404manual.com>

<http://www.luxmanual.com>

<http://aubethermostatmanual.com>

Golf course search by state

<http://golfingnear.com>

Email search by domain

<http://emailbydomain.com>

Auto manuals search

<http://auto.somanuals.com>

TV manuals search

<http://tv.somanuals.com>