

Panasonic®

Operating Instructions High Definition Custom Home Theater Plasma Display

Model No. **TH-50VX100U**
TH-65VX100U



The illustration shown is an image.

Before connecting, operating or adjusting this product, please read these instructions completely.
Please keep this manual for future reference.

HDMI™
HIGH-DEFINITION MULTIMEDIA INTERFACE

English

TQBC2372-1



The lightning flash with arrow-head within a triangle is intended to tell the user that parts inside the product are a risk of electric shock to persons.



The exclamation point within a triangle is intended to tell the user that important operating and servicing instructions are in the papers with the appliance.

WARNING : To prevent damage which may result in fire or shock hazard, do not expose this apparatus to rain or moisture.
Do not place containers with water (flower vase, cups, cosmetics, etc.) above the set.
(including on shelves above, etc.)

WARNING : 1) To prevent electric shock, do not remove cover. No user serviceable parts inside. Refer servicing to qualified service personnel.
2) Do not remove the grounding pin on the power plug. This apparatus is equipped with a three pin grounding-type power plug. This plug will only fit a grounding-type power outlet. This is a safety feature. If you are unable to insert the plug into the outlet, contact an electrician.
Do not defeat the purpose of the grounding plug.

This video monitor is designed to display television content from a separate TV tuner. Full-power analog TV broadcasting in the United States will end (as required by law) on February 17, 2009, after which full-power TV broadcasts will be digital only. If this device is used after that date to record or display programming from a product with a TV tuner that relies on a TV antenna, that product would need to contain a digital tuner, or a TV Converter would be necessary to tune the digital signal received with a TV antenna. Analog TVs should continue to work as before for other purposes (e.g., for watching low-power TV stations still broadcasting in analog, watching pre-recorded movies, or playing video games). When a Converter is used with an older television receiver or directly with this product, a signal splitter might be necessary to continue to receive low-power analog broadcasts via an antenna. For more information, please see www.DTV.gov or 1-888-CALL-FCC. For information on the TV Converter program, and on government coupons that may be used toward the purchase of one, see www.dtv2009.gov, or call the NTIA at 1-888-DTV-2009. Please check with your cable or satellite service provider if you have questions about your cable or satellite set-top box.

Important Safety Instructions

- 1) Read these instructions.
- 2) Keep these instructions.
- 3) Heed all warnings.
- 4) Follow all instructions.
- 5) Do not use this apparatus near water.
- 6) Clean only with dry cloth.
- 7) Do not block any ventilation openings. Install in accordance with the manufacturer's instructions.
- 8) Do not install near any heat sources such as radiators, heat registers, stoves, or other apparatus (including amplifiers) that produce heat.
- 9) Do not defeat the safety purpose of the polarized or grounding-type plug. A polarized plug has two blades with one wider than the other. A grounding type plug has two blades and a third grounding prong. The wide blade or the third prong are provided for your safety. If the provided plug does not fit into your outlet, consult an electrician for replacement of the obsolete outlet.
- 10) Protect the power cord from being walked on or pinched particularly at plugs, convenience receptacles, and the point where they exit from the apparatus.
- 11) Only use attachments / accessories specified by the manufacturer.
- 12) Use only with the cart, stand, tripod, bracket, or table specified by the manufacturer, or sold with the apparatus. When a cart is used, use caution when moving the cart / apparatus combination to avoid injury from tip-over.
- 13) Unplug this apparatus during lightning storms or when unused for long periods of time.
- 14) Refer all servicing to qualified service personnel. Servicing is required when the apparatus has been damaged in any way, such as power-supply cord or plug is damaged, liquid has been spilled or objects have fallen into the apparatus, the apparatus has been exposed to rain or moisture, does not operate normally, or has been dropped.
- 15) To prevent electric shock, ensure the grounding pin on the AC cord power plug is securely connected.



Dear Panasonic Customer

Welcome to the Panasonic family of customers. We hope that you will have many years of enjoyment from your new Plasma Display.

To obtain maximum benefit from your set, please read these Instructions before making any adjustments, and retain them for future reference.

Retain your purchase receipt as well, and record the model number and serial number of your set in the space provided on the rear cover of these instructions.

Table of Contents

Important Safety Instructions	3	Adjusting POS. /SIZE	31
FCC STATEMENT	5	SOUND Adjustment	33
Safety Precautions	6	SDI SOUND OUTPUT.....	33
Maintenance	7	SCREENSAVER (For preventing image retention) ..	34
Accessories	8	Reduces screen image retention.....	35
Accessories Supplied	8	SIDE BAR ADJUST	35
Remote Control Batteries	8	Specifying the scaler	36
Connections	9	Reduces power consumption	37
PC Input Terminals connection.....	10	Customizing the On-Screen Menu Display	38
SERIAL Terminals connection	11	SET UP for Input Signals	39
HDMI connection.....	12	COMPONENT / RGB IN SELECT.....	39
COMPONENT / RGB connection.....	12	YUV / RGB IN SELECT.....	39
Power ON / OFF	13	SIGNAL menu	40
Initial selections	14	XGA MODE	40
Selecting the input signal	14	REFRESH RATE	40
Selecting the On-Screen Menu Language	14	SYNC	41
Basic Controls	15	SDI THROUGH	41
SCROLLING BAR and TEST PATTERNS functions	17	Input signal display.....	41
EXT. SCALER function.....	17	OPTIONS Adjustments	42
ASPECT Controls	18	Watching Videos and DVDs	43
On-Screen Menu Displays	19	Programming the Remote to Operate Peripheral	
PICTURE Adjustments	21	Equipment	44
ADVANCED SETTINGS.....	23	Troubleshooting	45
Picture Profiles	25	List of Aspect Modes	46
Saving profiles.....	26	Remote Control Operation / Code List	47
Loading profiles	27	Applicable Input Signals	50
Editing profiles.....	28	Specifications	52
Locking profiles	29	Panasonic Professional Flat Panel Display Limited Warranty ..	53
		LIMITED WARRANTY STATEMENT	54
		Customer Service	55

FCC STATEMENT

This equipment has been tested and found to comply with the limits for a Class B digital device, pursuant to Part 15 of the FCC Rules. These limits are designed to provide reasonable protection against harmful interference in a residential installation. This equipment generates, uses and can radiate radio frequency energy and, if not installed and used in accordance with the instructions, may cause harmful interference to radio communications. However, there is no guarantee that interference will not occur in a particular installation. If this equipment does cause harmful interference to radio or television reception, which can be determined by turning the equipment off and on, the user is encouraged to try to correct the interference by one or more of the following measures:

- Reorient or relocate the receiving antenna.
- Increase the separation between the equipment and receiver.
- Connect the equipment into an outlet on a circuit different from that to which the receiver is connected.
- Consult the dealer or an experienced technician for help.

This device complies with Part 15 of the FCC Rules. Operation is subject to the following two conditions: (1) This device may not cause harmful interference, and (2) this device must accept any interference received, including interference that may cause undesired operation.

FCC CAUTION:

To assure continued compliance, follow the attached installation instructions and use only shielded interface cables when connecting to computer or peripheral devices. Any changes or modifications not expressly approved by Panasonic Corp. of North America could void the user's authority to operate this device.

FCC Declaration of Conformity

Model No. TH-50VX100U, TH-65VX100U

Responsible Party: Panasonic Corporation of North America
One Panasonic Way 1F-10, Secaucus, NJ 07094
Contact Source: Panasonic Professional Display Company
Panasonic Plasma Concierge 1-800-973-4390

CANADIAN NOTICE:

This Class B digital apparatus complies with Canadian ICES-003.

Note:

Do not allow a still picture to be displayed for an extended period, as this can cause a permanent image retention to remain on the Plasma Display.

Examples of still pictures include logos, video games, computer images, teletext and images displayed in 4:3 mode.

Trademark Credits

- VGA is a trademark of International Business Machines Corporation.
- Macintosh is a registered trademark of Apple Computer, USA.
- SVGA, XGA, SXGA and UXGA are registered trademarks of the Video Electronics Standard Association.
Even if no special notation has been made of company or product trademarks, these trademarks have been fully respected.
- HDMI, the HDMI logo and High-Definition Multimedia Interface are trademarks or registered trademarks of HDMI Licensing LLC.

Safety Precautions

CAUTION

This Plasma Display is for use only with the following optional accessories. Use with any other type of optional accessories may cause instability which could result in the possibility of injury.

(All of the following accessories are manufactured by Panasonic Corporation.)

- PedestalTY-ST50VX100 (for TH-50VX100U),
TY-ST65VX100 (for TH-65VX100U)
- Wall-hanging bracket (vertical).....TY-WK42PV7 (for TH-50VX100U),
TY-WK65PV7 (for TH-65VX100U)
- Wall-hanging bracket (angled)TY-WK42PR7 (for TH-50VX100U),
TY-WK65PR8 (for TH-65VX100U)
- BNC Component Video Terminal BoardTY-42TM6A
- RCA Component Video Terminal Board.....TY-42TM6Z
- HD-SDI Terminal BoardTY-FB9HD
- HD-SDI Terminal Board with audioTY-FB10HD
- Dual Link HD-SDI Terminal BoardTY-FB11DHD
- Dual HDMI Terminal BoardTY-FB10HMD
- DVI-D Terminal BoardTY-FB11DD
- Ir Through Terminal BoardTY-FB9RT

Always be sure to ask a qualified technician to carry out set-up.

Small parts can present choking hazard if accidentally swallowed. Keep small parts away from young children. Discard unneeded small parts and other objects, including packaging materials and plastic bags/sheets to prevent them from being played with by young children, creating the potential risk of suffocation.

■ When using the Plasma Display

Do not bring your hands, face or objects close to the ventilation holes of the Plasma Display.

- Top of the Plasma Display is usually very hot due to the high temperature of exhaust air being released through the ventilation holes. Burns or personal injuries can happen if any body parts are brought too close. Placing any object near the top of the display could also result in heat damages to the object as well as to the Display if its ventilation holes are blocked.

Be sure to disconnect all cables before moving the Plasma Display.

- Moving the Display with its cables attached might damage the cables which, in turn, can cause fire or electric shock.

Disconnect the power plug from the wall outlet as a safety precaution before carrying out any cleaning.

- Electric shocks can result if this is not done.

Clean the power cable regularly to prevent it from becoming dusty.

- Built-up dust on the power cord plug can increase humidity which might damage the insulation and cause fire. Unplug the cord from the wall outlet and clean it with a dry cloth.

This Plasma Display radiates infrared rays, therefore it may affect other infrared communication equipment.

Install your infrared sensor in a place away from direct or reflected light from your Plasma Display.

Note:

Do not allow a still picture to be displayed for an extended period, as this can cause a permanent image retention to remain on the Plasma Display. Examples of still pictures include logos, video games, computer images, teletext and images displayed in 4:3 mode.

WARNING

■ Setup

Do not place the Plasma Display on sloped or unstable surfaces.

- The Plasma Display may fall off or tip over.

Do not place any objects on top of the Plasma Display.

- If water spills onto the Plasma Display or foreign objects get inside it, a short-circuit may occur which could result in fire or electric shock. If any foreign objects get inside the Plasma Display, please consult an Authorized Service Center.

Do not cover the ventilation holes.

- Doing so may cause the Plasma Display to overheat, which can cause fire or damage to the Plasma Display.

Transport only in upright position!

- Transporting the unit with its display panel facing upright or downward may cause damage to the internal circuitry.

If using the pedestal (optional accessory), leave a space of 3 15/16" (10 cm) or more at the top, left and right, and 2 3/4" (7 cm) or more at the rear, and also keep the space between the bottom of the display and the floor surface. If using some other setting-up method, follow the manual of it. (If there is no specific indication of installation dimension in the installation manual, leave a space of 3 15/16" (10 cm) or more at the top, bottom, left and right, and 2 3/4" (7 cm) or more at the rear.)

An apparatus with CLASS I construction shall be connected to a mains socket outlet with a protective earthing connection.

■ AC Power Supply Cord

The Plasma Display is designed to operate on 110 - 127 V AC, 50/60 Hz.

Do not use any power supply cord other than that provided with this unit.

- Doing so may cause fire or electric shocks.

Securely insert the power cord plug as far as it will go.

- If the plug is not fully inserted, heat may be generated which could cause fire. If the plug is damaged or the wall socket plate is loose, they should not be used.

Do not handle the power cord plug with wet hands.

- Doing so may cause electric shocks.

Do not do anything that might damage the power cable. When disconnecting the power cable, hold the plug, not the cable.

- Do not make any modifications, place heavy objects on, place near hot objects, heat, bend, twist or forcefully pull the power cable. Doing so may cause damage to the power cable which can cause fire or electric shock. If damage to the cable is suspected, have it repaired at an Authorized Service Center.

If the Plasma Display will not be used for a long period of time, unplug the power cord from the wall outlet.

■ If problems occur during use

If a problem occurs (such as no picture or no sound), or if smoke or an abnormal odor is detected from the Plasma Display, unplug the power cord immediately.

- Continuous use of the Display under these conditions might cause fire or permanent damage to the unit. Have the Display evaluated at an Authorized Service Center. Services to the Display by any unauthorized personnel are strongly discouraged due to its high voltage dangerous nature.

If water or foreign objects get inside the Plasma Display, if the Plasma Display is dropped, or if the cabinet becomes damaged, disconnect the power cord plug immediately.

- A short may occur, which could cause fire. Contact an Authorized Service Center for any repairs that need to be made.

Maintenance

The front of the display panel has been specially treated. Wipe the panel surface gently using only a cleaning cloth or a soft, lint-free cloth.

- If the surface is particularly dirty, wipe with a soft, lint-free cloth which has been soaked in pure water or water in which neutral detergent has been diluted 100 times, and then wipe it evenly with a dry cloth of the same type until the surface is dry.
- Do not scratch or hit the surface of the panel with fingernails or other hard objects, otherwise the surface may become damaged. Furthermore, avoid contact with volatile substances such as insect sprays, solvents and thinner, otherwise the quality of the surface may be adversely affected.

If the cabinet becomes dirty, wipe it with a soft, dry cloth.

- If the cabinet is particularly dirty, soak the cloth in water to which a small amount of neutral detergent has been added and then wring the cloth dry. Use this cloth to wipe the cabinet, and then wipe it dry with a dry cloth.
- Do not allow any detergent to come into direct contact with the surface of the Plasma Display. If water droplets get inside the unit, operating problems may result.
- Avoid contact with volatile substances such as insect sprays, solvents and thinner, otherwise the quality of the cabinet surface may be adversely affected or the coating may peel off. Furthermore, do not leave it for long periods in contact with articles made from rubber or PVC.

Accessories

Accessories Supplied

Check that you have the Accessories and items shown

Operating Instruction book

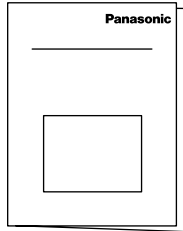

Remote Control Transmitter N2QAYB000323



Batteries for the Remote Control Transmitter (2 × AA Size)

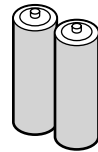

Fixing band × 1

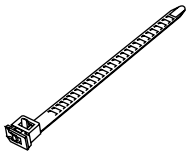

AC cord

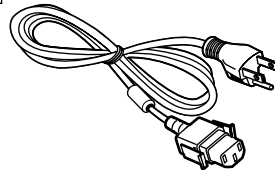

Remote Control Batteries

Requires two AA batteries.

1. Pull and hold the hook, then open the battery cover.

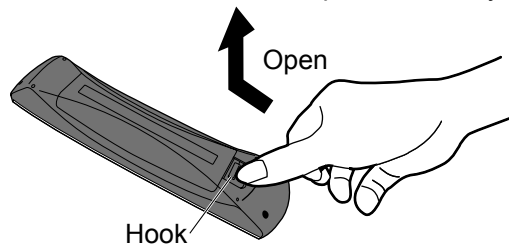

2. Insert batteries - note correct polarity (+ and -).

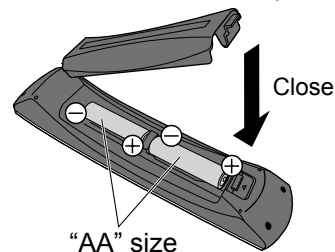

Helpful Hint:

For frequent remote control users, replace old batteries with Alkaline batteries for longer life.

Precaution on battery use

Incorrect installation can cause battery leakage and corrosion that will damage the remote control transmitter. Disposal of batteries should be in an environment-friendly manner.

Observe the following precautions:

1. Batteries should always be replaced as a pair. Always use new batteries when replacing the old set.
2. Do not combine a used battery with a new one.
3. Do not mix battery types (example: "Zinc Carbon" with "Alkaline").
4. Do not attempt to charge, short-circuit, disassemble, heat or burn used batteries.
5. Battery replacement is necessary when the remote control acts sporadically or stops operating the Plasma Display.
6. Do not burn or breakup batteries.
Batteries must not be exposed to excessive heat such as sunshine, fire or the like.
7. Make a note of the remote control codes before changing batteries in case the codes are reset. (see page 44)

Connections

When connecting the speakers, be sure to use only the optional accessory speakers. Refer to the speaker's Installation Manual for details on speaker installation.

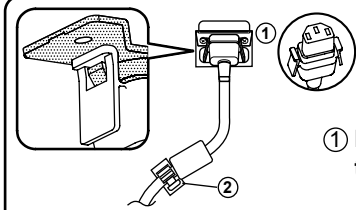
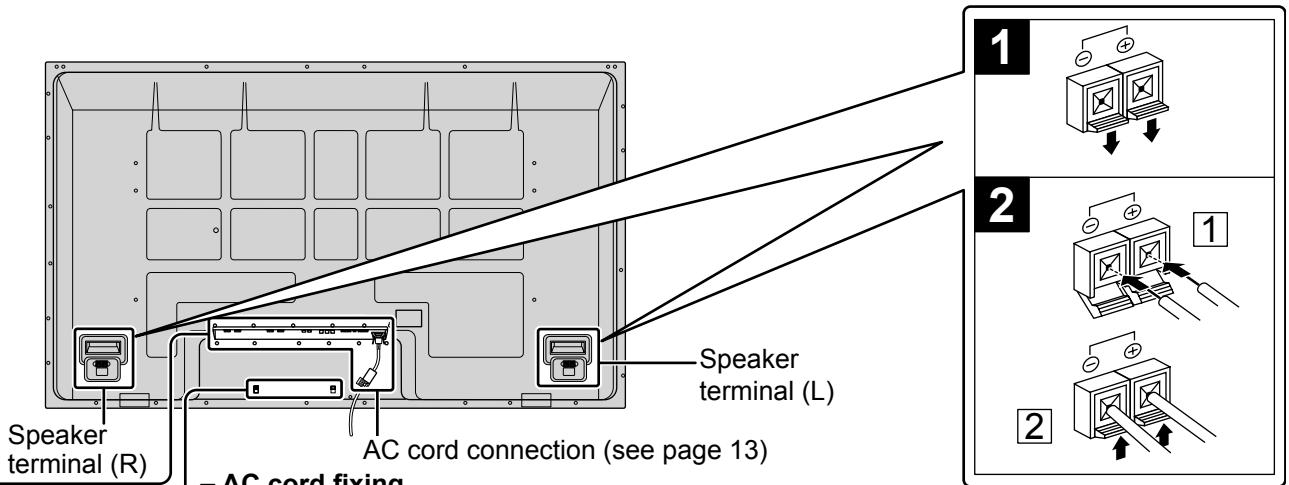

Note:
Make sure that the AC cord is locked on both the left and right sides.

- 1 Plug the AC cord into the display unit.**
Plug the AC cord until it clicks.
- 2 Fix the AC cord with the clammer which is attached to the unit.**

Close

Push until the hook clicks.

Open

1. Keep the knob pressed.
2. Pull off.

Unplug the AC cord

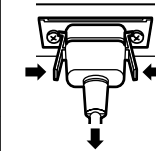

Unplug the AC cord pressing the two knobs.

Note:
When disconnecting the AC cord, be absolutely sure to disconnect the AC cord plug at the socket outlet first.

– Cable fixing band

Secure any excess cables with band as required.

Note:

One fixing band is supplied with this unit. In case of securing cables at two positions, please purchase it separately.

Pass the attached cable fixing band through the clip as shown in the figure.

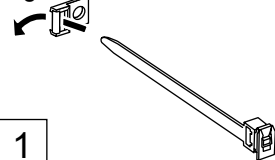

To secure cables connected to Terminals, wrap the cable fixing band around them then pass the pointed end through the locking block, as shown in the figure. **While ensuring there is sufficient slack in cables to minimize stress (especially in the power cord), firmly bind all cables with the supplied fixing band.**

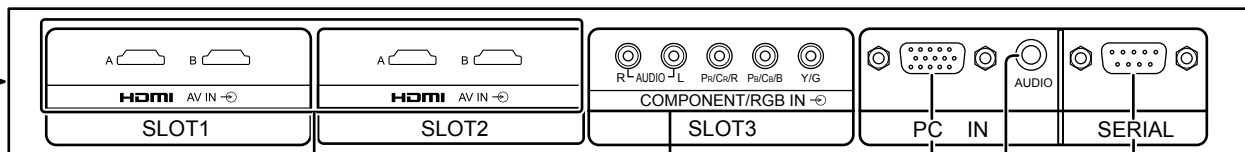
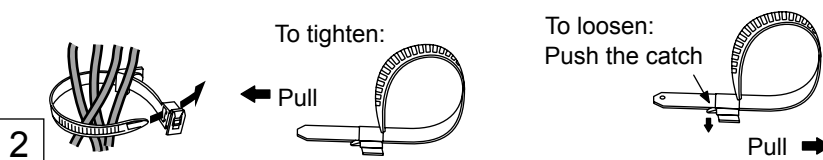

Dual HDMI Terminals (equivalent of Dual HDMI Terminal Board (TY-FB10HMD)) (see page 12)

COMPONENT/RGB IN and Audio IN Terminals (equivalent of RCA Component Video Terminal Board (TY-42TM6Z)) (see page 12)

From EXTERNAL monitor terminal on Computer (see page 10)

From SERIAL Terminal on Computer (see page 11)

Note: At factory shipment, Terminal boards are installed in SLOT 1, SLOT 2 and SLOT 3.

PC Input Terminals connection

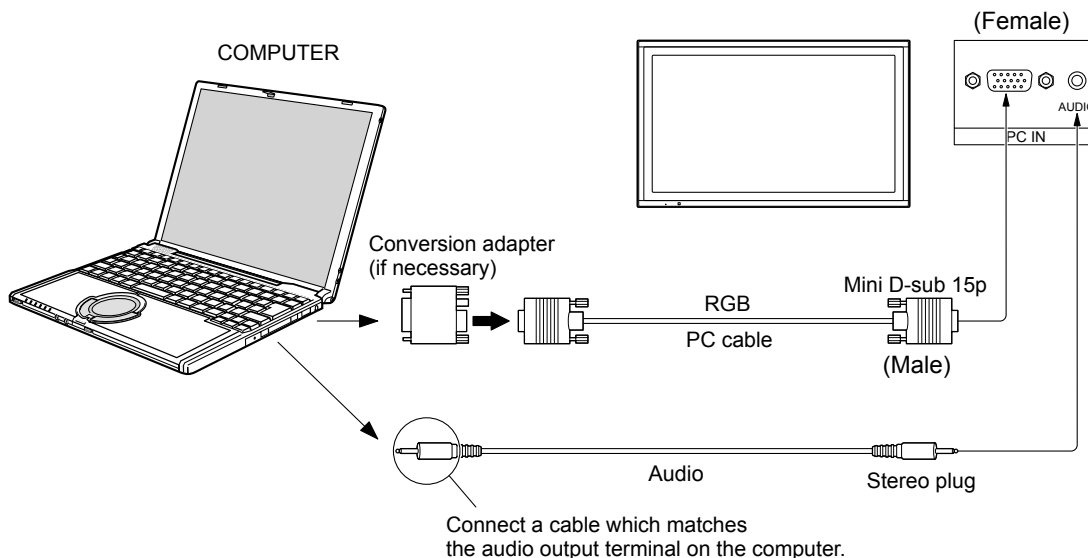

Notes:

- Due to space limitations, occasionally you may have trouble connecting Mini D-sub 15P cable with ferrite core to PC input Terminal.
- With regard to the typical PC input signals that are described in the applicable input signals list (see page 50), adjustment values such as for the standard picture positions and sizes have already been stored in this unit. You can add up to eight PC input signal types that are not included in the list.
- Computer signals which can be input are those with a horizontal scanning frequency of 15 to 110 kHz and vertical scanning frequency of 48 to 120 Hz. (However, the image will not be displayed properly if the signals exceed 1,200 lines.)
- The display resolution is a maximum of 1,440 × 1,080 dots when the aspect mode is set to “4:3”, and 1,920 × 1,080 dots when the aspect mode is set to “FULL”. If the display resolution exceeds these maximums, it may not be possible to show fine detail with sufficient clarity.
- The PC input terminals are DDC2B-compatible. If the computer being connected is not DDC2B-compatible, you will need to make setting changes to the computer at the time of connection.
- Some PC models cannot be connected to the set.
- There is no need to use an adapter for computers with DOS/V compatible Mini D-sub 15P terminal.
- The computer shown in the illustration is for example purposes only.
- Additional equipment and cables shown are not supplied with this set.
- Do not set the horizontal and vertical scanning frequencies for PC signals which are above or below the specified frequency range.
- Component Input is possible with the pin 1, 2, 3 of the Mini D-sub 15P Connector.
- Change the “COMPONENT/RGB-IN SELECT” setting in the “SET UP” menu to “COMPONENT” (when COMPONENT signal connection) or “RGB” (when RGB signal connection). (see page 39)

Signal Names for Mini D-sub 15P Connector

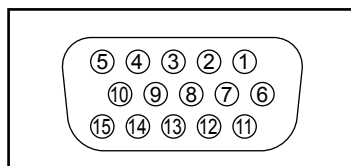

Pin No.	Signal Name	Pin No.	Signal Name	Pin No.	Signal Name
①	R (P _R /C _R)	⑥	GND (Ground)	⑪	NC (not connected)
②	G (Y)	⑦	GND (Ground)	⑫	SDA
③	B (P _B /C _B)	⑧	GND (Ground)	⑬	HD/SYNC
④	NC (not connected)	⑨	+5 V DC	⑭	VD
⑤	GND (Ground)	⑩	GND (Ground)	⑮	SCL

SERIAL Terminals connection

The SERIAL terminal is used when the Plasma Display is controlled by a computer.

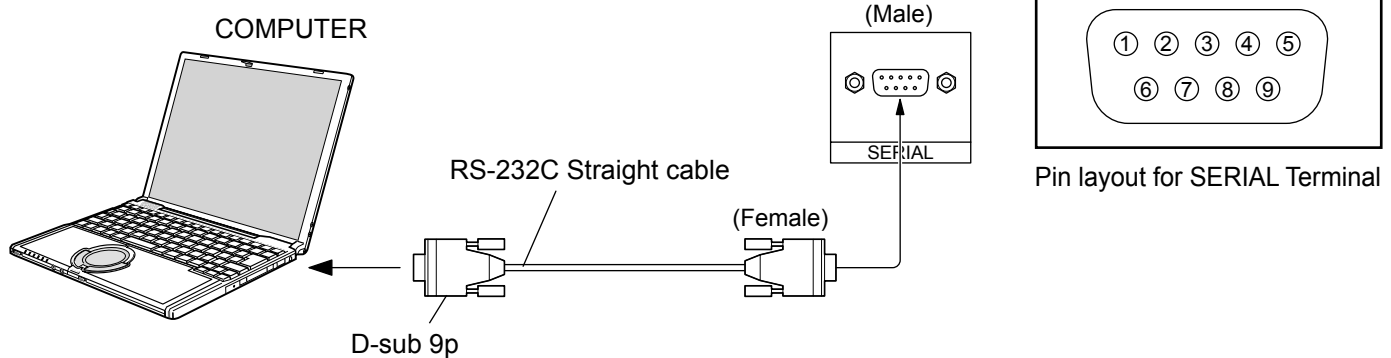

Notes:

- Use the RS-232C straight cable to connect the computer to the Plasma Display.
- The computer shown is for example purposes only.
- Additional equipment and cables shown are not supplied with this set.

The SERIAL terminal conforms to the RS-232C interface specification, so that the Plasma Display can be controlled by a computer which is connected to this terminal. The computer will require software which allows the sending and receiving of control data which satisfies the conditions given below. Use a computer application such as programming language software. Refer to the documentation for the computer application for details.

Signal names for D-sub 9P connector

Pin No.	Details
②	R X D
③	T X D
⑤	GND
④ • ⑥	Non use
⑦	← (Shorted in this set)
⑧	
① • ⑨	NC

These signal names are those of computer specifications.

Communication parameters

Signal level	RS-232C compliant
Synchronization method	Asynchronous
Baud rate	9600 bps
Parity	None
Character length	8 bits
Stop bit	1 bit
Flow control	-

Basic format for control data

The transmission of control data from the computer starts with a STX signal, followed by the command, the parameters, and lastly an ETX signal in that order. If there are no parameters, then the parameter signal does not need to be sent.

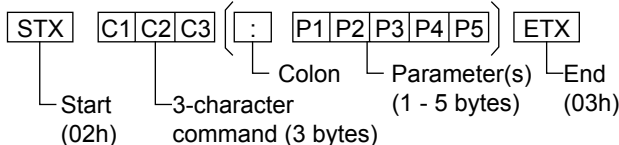

Notes:

- If multiple commands are transmitted, be sure to wait for the response for the first command to come from this unit before sending the next command.
- If an incorrect command is sent by mistake, this unit will send an "ER401" command back to the computer.
- SL1A, SL1B, SL2A and SL2B of Command IMS are available only when a dual input terminal board is attached.

Command

Command	Parameter	Control details
PON	None	Power ON
POF	None	Power OFF
AVL	**	Volume 00 - 63
IMS	None	Input select (toggle)
	SL1	Slot1 input
	SL2	Slot2 input
	SL3	Slot3 input
	PC1	PC input
	SL1A	Slot1 input (INPUT1A)
	SL1B	Slot1 input (INPUT1B)
	SL2A / SL2B	Slot2 input (INPUT2A) / Slot2 input (INPUT2B)
DAM	None	Screen mode select (toggle)
	ZOOM	ZOOM
	FULL	FULL
	JUST	JUST
	NORM	4:3
	SJST	JUST
	SNOM	4:3
	SFUL	H-FILL

With the power off, this display responds to PON command only.

HDMI connection

This unit has terminal boards equivalent to Dual HDMI Terminal Board (TY-FB10HMD) and RCA Component Video Terminal Board (TY-42TM6Z) as standard equipment.

[Pin assignments and signal names]

Pin No.	Signal	Pin No.	Signal
①	T.M.D.S Data2+	⑪	T.M.D.S Clock Shield
②	T.M.D.S Data2 Shield	⑫	T.M.D.S Clock-
③	T.M.D.S Data2-	⑬	CEC
④	T.M.D.S Data1+	⑭	Reserved (N.C. on device)
⑤	T.M.D.S Data1 Shield		
⑥	T.M.D.S Data1-	⑮	SCL
⑦	T.M.D.S Data0+	⑯	SDA
⑧	T.M.D.S Data0 Shield	⑰	DDC/CEC Ground
⑨	T.M.D.S Data0-	⑱	+5V Power
⑩	T.M.D.S Clock+	⑲	Hot Plug Detect

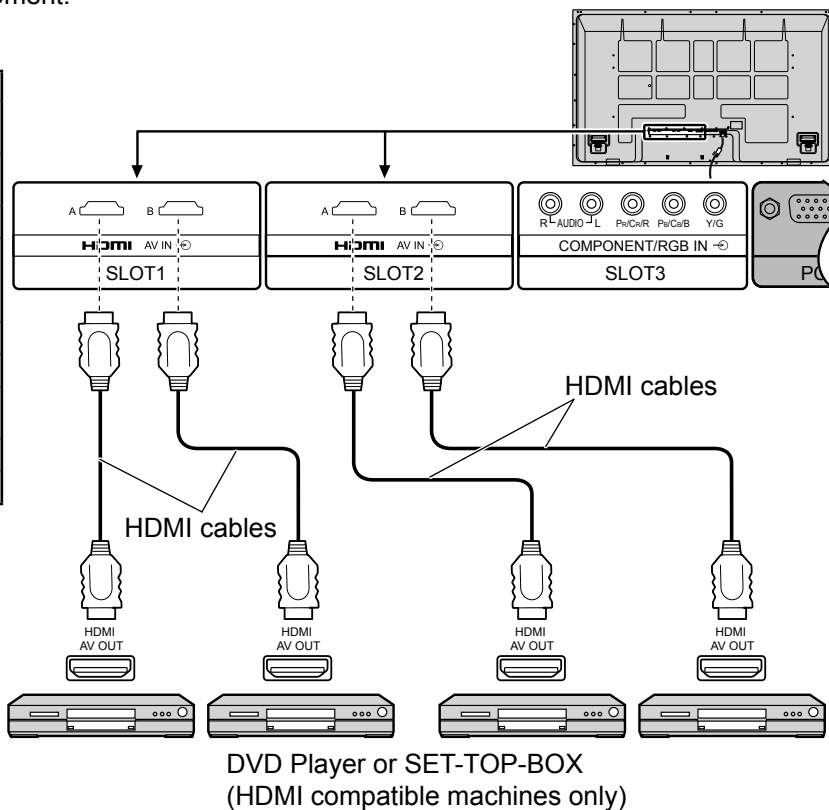
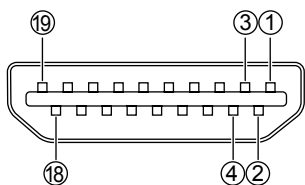

Note:

Additional equipment and HDMI cables shown are not supplied with this set.

COMPONENT / RGB connection

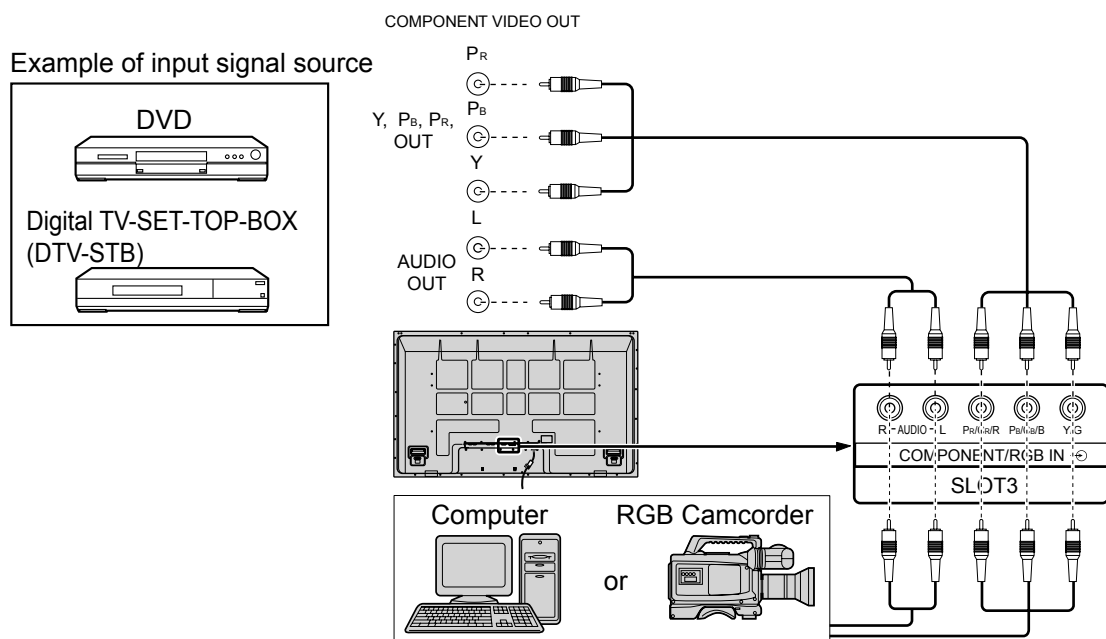

Notes:

- Change the "COMPONENT/RGB-IN SELECT" setting in the "SET UP" menu to "COMPONENT" (when COMPONENT signal connection) or "RGB" (when RGB signal connection). (see page 39)
- Additional equipment, cables and adapter plugs shown are not supplied with this set.
- SYNC ON G signal is needed. (see page 41)

Power ON / OFF

Connecting the AC cord plug to the Plasma Display.

Fix the AC cord plug securely to the Plasma Display with the clamber. (see page 9)

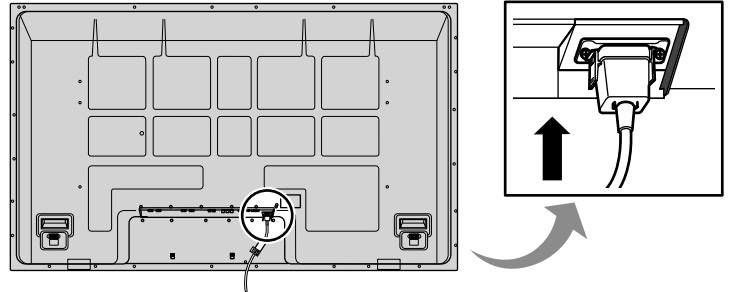

Connecting the plug to the Wall Outlet.

Note:

When disconnecting the AC cord, be absolutely sure to disconnect the AC cord plug at the socket outlet first.

Press the Power switch on the Plasma Display to turn the set on: Power-On.

Power Indicator: Green

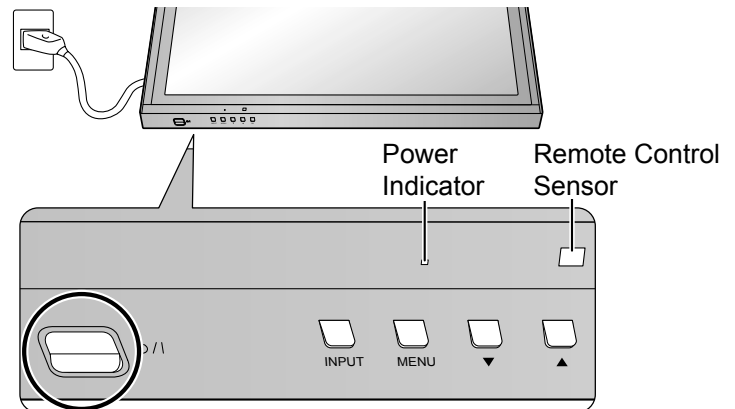

When first switching on the unit

Following screen will be displayed when the unit is turned on for the first time. Select the language with the remote control. Unit buttons are invalid.

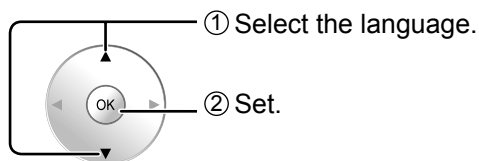

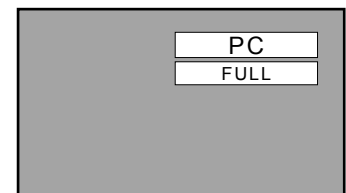

From the second time on, the below screen is displayed for a while (setting condition is an example).

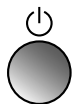

Notes:

- Once the language is set, this screen won't be displayed when switching on the unit next time.
- After the setting, language selection can be done from the SET UP menu. (see page 14)



Press the  button on the remote control to turn the Plasma Display off.

Power Indicator: Red (standby)

Press the  button on the remote control to turn the Plasma Display on.

Power Indicator: Green

Turn the power to the Plasma Display off by pressing the  switch on the unit, when the Plasma Display is on or in standby mode.

Note:

During operation of the power management function, the power indicator turns orange in the power off state.



Initial selections

Selecting the input signal

Select the input signals to be connected by installing the optional Terminal Boards.

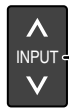

Press to select the input signal to be played back from the equipment which has been connected to the Plasma Display.

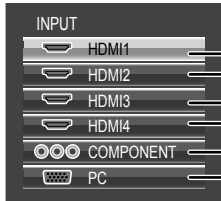

HDMI1 — HDMI signal terminal in SLOT1
 HDMI2 — HDMI signal terminal in SLOT2
 HDMI3 — HDMI signal terminal in SLOT2
 HDMI4 — HDMI signal terminal in SLOT2
 COMPONENT — COMPONENT or RGB signal terminal in SLOT3
 PC — PC signal terminal in PC IN

Using dedicated buttons for input selection



Press to select HDMI signal terminals 1-4 in SLOT 1 and 2.



Press to select component or RGB signal terminal in SLOT 3.



Press to select PC signal terminal in PC IN.

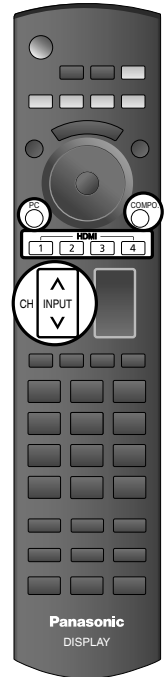

Notes:

- Selecting is also possible by pressing the INPUT button on the unit.
- Input terminal will not be selected if the terminal board is not installed into the SLOT.
- Select to match the signals from the source connected to the component/RGB input terminals. (see page 39)
- Image retention (image lag) may occur on the plasma display panel when a still picture is kept on the panel for an extended period. The function that darkens the screen slightly is activated to prevent image retention (see page 45), but this function is not the perfect solution to image retention.

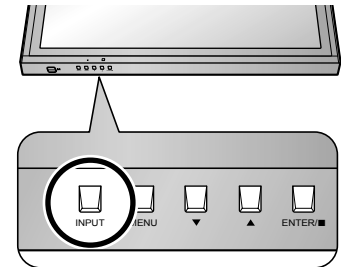

Selecting the On-Screen Menu Language



Press to display the menu screen.

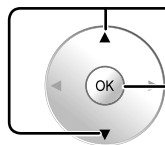

Press to select "SET UP".

Press to display the SET UP menu.

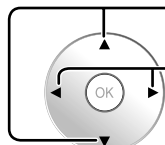

Press to select OSD LANGUAGE.
 Press to select your preferred language.

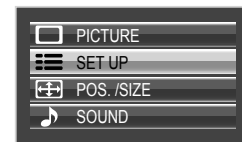

Selectable languages

- English(UK)
- Deutsch
- Français
- Italiano
- Español
- ENGLISH(US)
- 日本語 (Japanese)
- Русский (Russian)

SET UP menu

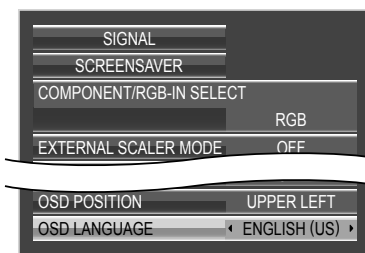

Basic Controls

Main Unit

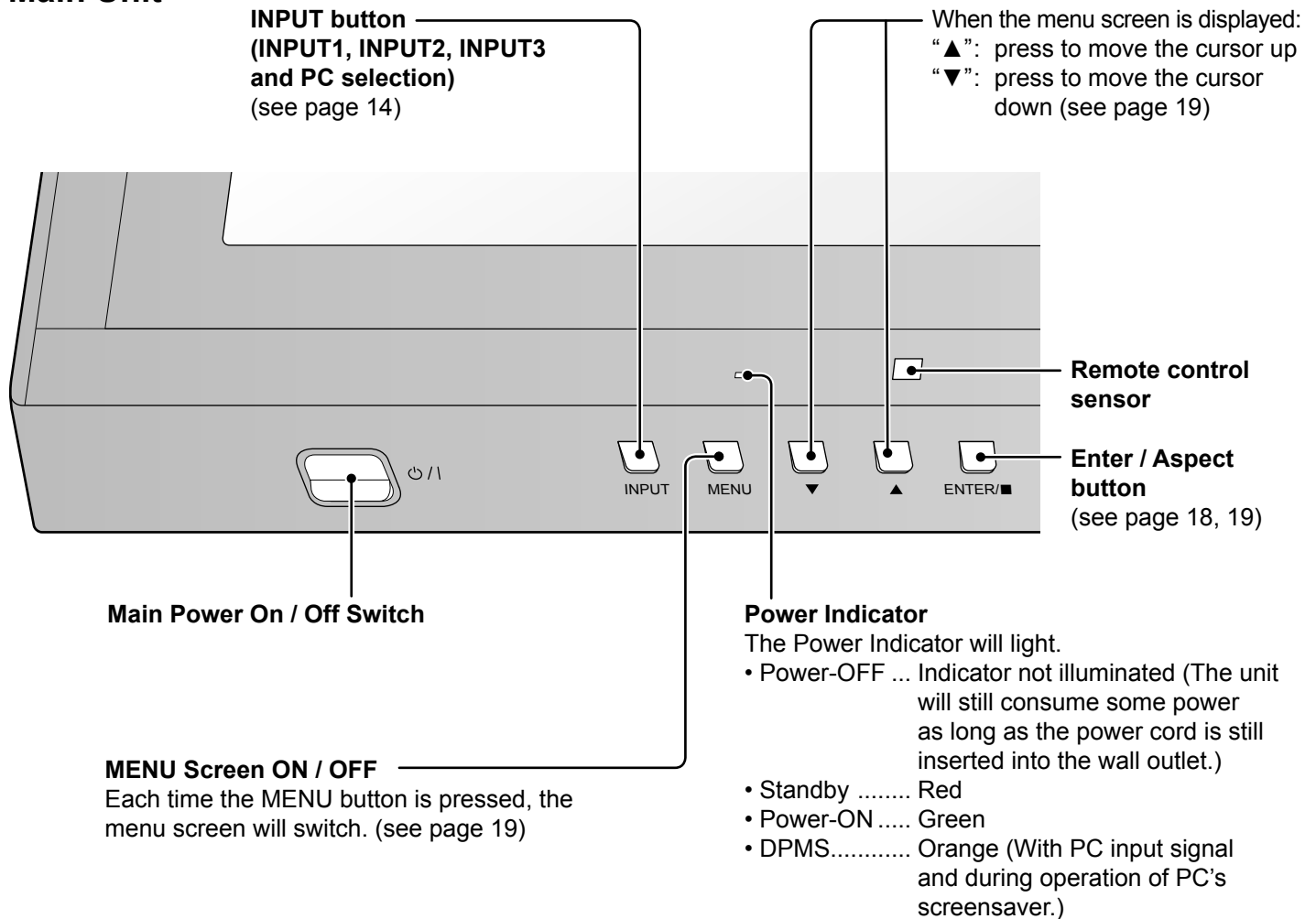

Remote Control Transmitter

POS. /SIZE button
(see page 31)

Standby (ON / OFF) button
The Plasma Display must first be plugged into the wall outlet and turned on at the power switch (see page 13). Press this button to turn the Plasma Display On, from Standby mode. Press it again to turn the Plasma Display Off to Standby mode.

FUNCTION button
(see page 17)

OK button
Press to make selections.

POSITION buttons

PC button
Press to select PC input. (see page 14)

DIRECT INPUT buttons
Press the each button to select the INPUT mode. (see page 14)
This button is used to switch directly to INPUT mode.

INPUT button
(see page 14)

VIDEO MENU button
Press to select PICTURE MENU.
(see page 21)

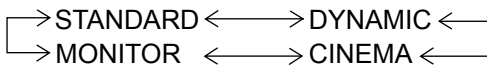

EXT.SCALER button
(see page 17)

ASPECT button
Press to adjust the aspect.
(see page 18)

Numeric buttons
(see page 27)

MEM. LOAD button
(see page 27)

External equipment operations
(see page 43)

PICTURE button
(see page 21)

LIGHT button
Lights the INPUT and VIDEO MENU buttons for 5 seconds. Makes the selected remote control mode key (DISPLAY, VCR, DBS/CBL or DVD) flash three times. Press again to turn off the INPUT and VIDEO MENU button lights.

Equipment (Remote control mode) selection buttons (see page 43, 44)

MENU button

Displays menu screen. (see page 19)

RETURN button (see page 19)

Press the RETURN button to return to previous menu screen.

COMPO. button

Press to select COMPONENT or RGB input. (see page 14)

OFF TIMER button

The Plasma Display can be preset to switch to stand-by after a fixed period. The setting changes to 30 minutes, 60 minutes, 90 minutes and 0 minutes (off timer cancelled) each time the button is pressed.

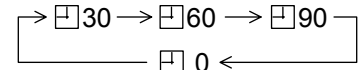

When three minutes remain, "OFF TIMER 3" will flash.
The off timer is cancelled if a power interruption occurs.

RECALL button

Press to display the current system status.

- ① Input label
- ② Aspect mode (see page 18)
- ③ Off timer

The off timer indicator is displayed only when the off timer has been set.

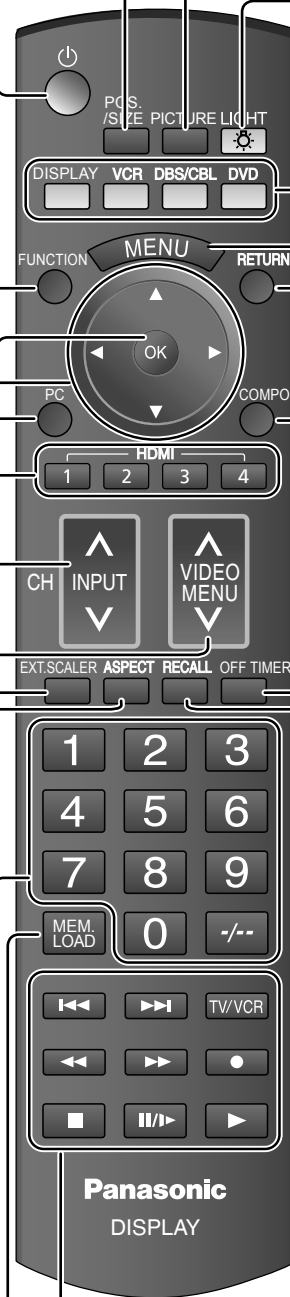
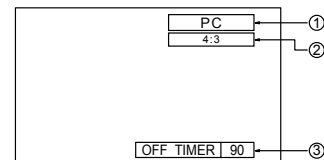

SCROLLING BAR and TEST PATTERNS functions

Pressing  activates one of the following two functions. The function button setting can be configured by accessing "Function button assign" in the OPTIONS menu. (see page 42)

SCROLLING BAR

FUNCTION  Press



Activates the SCROLLING BAR ONLY screensaver. After 15 minutes, the display enters standby mode.

SCROLLING BAR ONLY



To exit this mode, press any button.

Note:

AUTO POWER OFF is deactivated during SCROLLING BAR or TEST PATTERNS operation. (see page 37)

TEST PATTERNS

FUNCTION  Press



Each time you press , a different test pattern is displayed (seven in all).

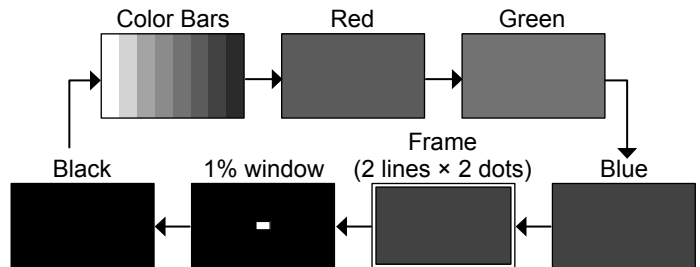

To exit this mode, press any button other than .

EXT. SCALER function

Each time you press , an external scaler is activated or deactivated.

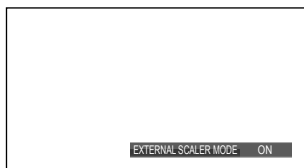

OFF: Use the built-in scaler.
ON: Use an external scaler.

The setting is valid with the following signals.

1125 (1080) / 24p • 25p • 30p • 50p • 60p

With input signals other than these, specifying "ON" will display the following message.

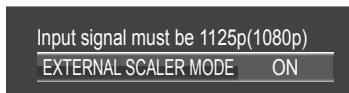

Note:

You can also turn the built-in scaler ON and OFF by accessing "EXTERNAL SCALER MODE" in the SET UP menu. (see page 36)

ASPECT Controls

The Plasma Display will allow you to enjoy viewing the picture at its maximum size, including wide screen cinema format picture.

Note:

Be aware that if you put the display in a public place for commercial purposes or a public showing and then use the aspect mode select function to shrink or expand the picture, you may be violating the copyright under copyright law. It is prohibited to show or alter the copyrighted materials of other people for commercial purposes without the prior permission of the copyright holder.

ASPECT



Press repeatedly to move through the aspect options:
For details about the aspect mode, please see "List of Aspect Modes" (page 46).

[from the unit]



The aspect mode changes each time the ENTER button is pressed.



For PC signal input:

→ 4:3 → ZOOM → FULL →

For SD signal input (525 (480) / 60i • 60p, 625 (575) / 50i • 50p):

→ 4:3 → ZOOM → FULL → JUST →

For HD signal input [1125 (1080) / 60i • 50i • 60p • 50p • 24p • 25p • 30p • 24sF, 1250 (1080) / 50i, 750 (720) / 60p • 50p]:

→ 4:3 → H-FILL → ZOOM → FULL → JUST →

Notes:

- The aspect mode is memorized separately for each input terminal.
- Do not allow the picture to be displayed in 4:3 mode for an extended period, as this can cause a permanent image retention to remain on the Plasma Display Panel.

All Aspect mode

Set "All Aspect" to "On" in OPTION menu to enable the extended aspect mode (page 42). When All Aspect mode, the aspect mode of pictures is switched as follows. For details about the aspect mode, please see "List of Aspect Modes" (page 46).

For PC signal input:

→ 4:3 → Zoom → 16:9 →

For SD signal input (525 (480) / 60i • 60p, 625 (575) / 50i • 50p):

→ 4:3 → Zoom1 → Zoom2 → Zoom3 → 16:9 → 14:9 → Just →

For HD signal input [1125 (1080) / 60i • 50i • 60p • 50p • 24p • 25p • 30p • 24sF, 1250 (1080) / 50i, 750 (720) / 60p • 50p]:

→ 4:3 Full → Zoom1 → Zoom2 → Zoom3 → 16:9 → 14:9 → Just1 → Just2 → 4:3 (1) → 4:3 (2) →

On-Screen Menu Displays

Various menus allow you to make settings for the picture, sound, and other functions so that you can enjoy watching Display best suited for you.



Press to return to the previous menu.



1 Display the menu screen.

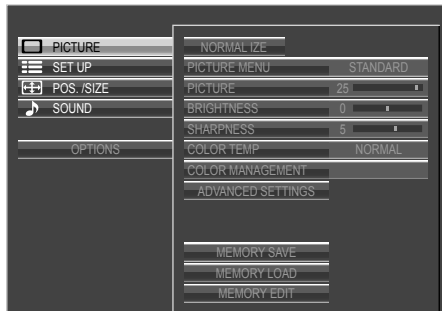

Remote Control



Unit

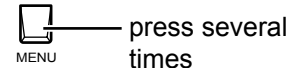

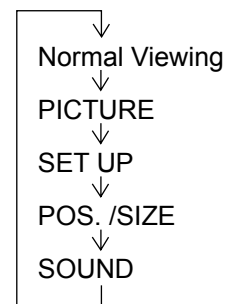

Each time the MENU button is pressed, the menu screen will switch.

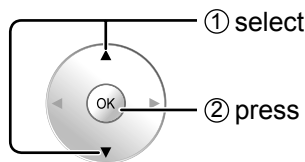
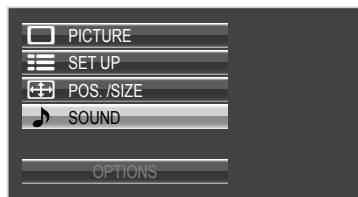

2 Select the menu.



(Example: SOUND menu)

Menus can also be accessed directly by pressing dedicated buttons, such as  and .

3 Select the item.

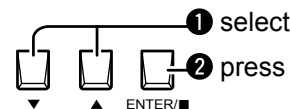
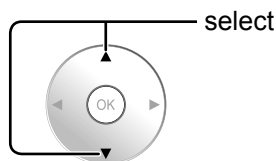

(Example: SOUND menu)

4 Set.

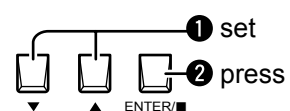
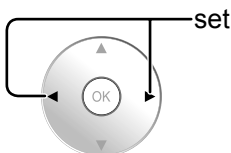

5 Exit the menu.

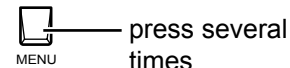

On-Screen Menu Displays

Overview

Note: Menu that cannot be adjusted is grayout. Adjustable menu changes depending on signal, input and menu setting.

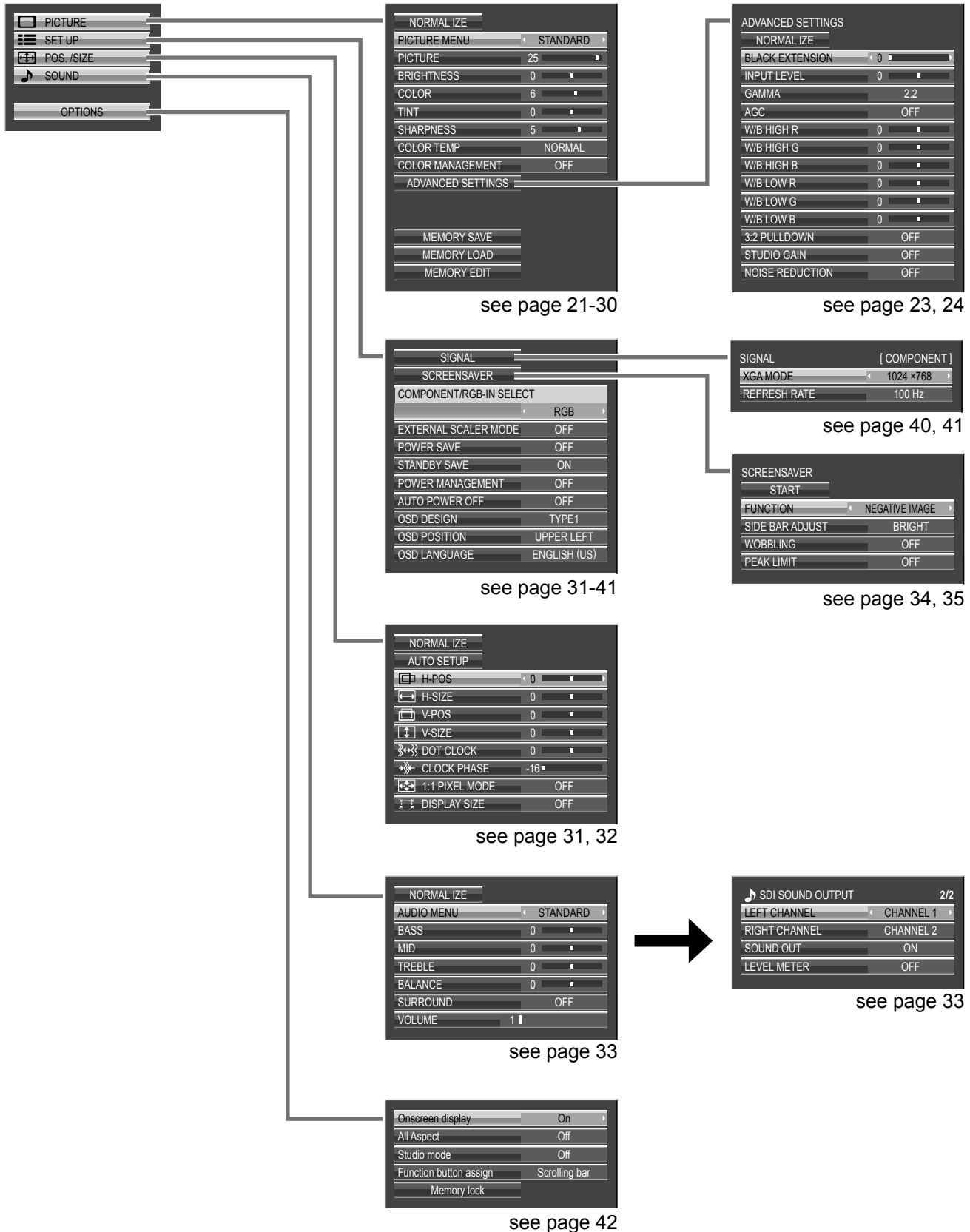

PICTURE Adjustments

1 Display the menu screen.



2 Select "PICTURE".

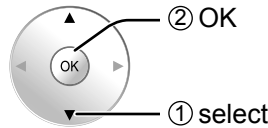
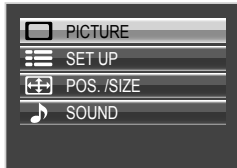

During "RGB" and "PC" input signal.

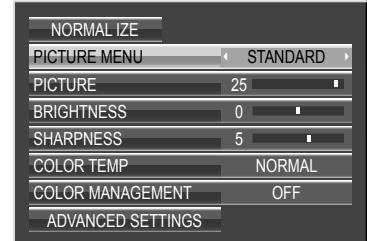

3 Select the item and set.

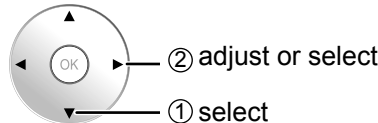
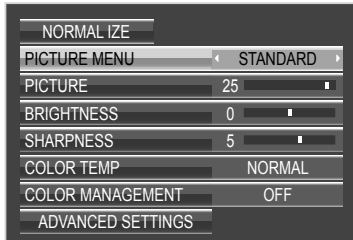

During "Digital" and "COMPONENT" input signal.

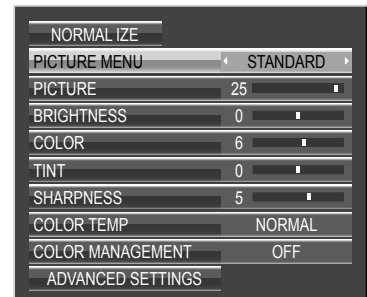

4 Exit the menu.



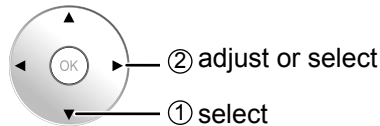

Using for menu display

To display a menu for adjustment of the PICTURE menu on the bottom of the screen, press .



To display a menu for ADVANCED SETTINGS adjustment, press  again.



To hide the menu, press  or .

PICTURE MENU

You can switch to the optimal picture mode for the video source and viewing environment.

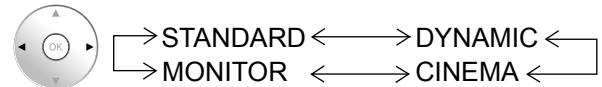

STANDARD:

For viewing in standard (evening lighting) environments. This menu selects the normal levels of BRIGHTNESS and PICTURE.

DYNAMIC:

For viewing in brighter environments. This menu selects higher than normal levels of BRIGHTNESS and PICTURE.

Notes:

- When "MONITOR" is selected in PICTURE MENU, the following menu items cannot be set.

PICTURE menu: PICTURE

SCREENSAVER menu: PEAK LIMIT (see page 35)

SET UP menu: POWER SAVE (see page 37)

- If you would like to change the picture and color of the selected PICTURE menu to something else, adjust using the items in the PICTURE menu. (see next page)

CINEMA:

Ideal for movies.

MONITOR:

For use when creating broadcast or movie content. With this picture, even if the overall average picture level (APL) changes, the brightness of areas with the same signal level does not change.

PICTURE Adjustments

- **PICTURE** Adjusts the proper picture contrast.
- **BRIGHTNESS** Adjusts for easier viewing of dark pictures such as night scenes and black hair.
- **COLOR** Adjusts color saturation.
- **TINT** Adjusts for natural flesh tones.
- **SHARPNESS** Adjusts picture sharpness.



- **COLOR TEMP** Switches to various screen color tones.
 - NORMAL:** Intermediate color temperature.
 - COOL:** Colors with a bluish tinge.
 - STUDIO:** Optimal color temperature for studio viewing (3200 K).
 - WARM:** Colors with a reddish tinge.

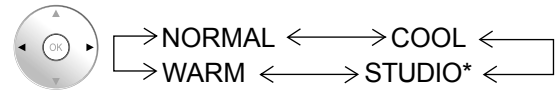

* "STUDIO" can be modified when "Studio mode" in the OPTIONS menu is "On". (see page 42)

- **COLOR MANAGEMENT**
 - ON:** Enables color adjustment automatically.



Notes:

- "COLOR" and "TINT" settings cannot be adjusted for "RGB/PC" input signal.
- You can change the level of each function (PICTURE, BRIGHTNESS, COLOR, TINT, SHARPNESS) for each PICTURE MENU.
- The setting details for STANDARD, DYNAMIC and CINEMA respectively are memorized separately for each input terminal.
- In PICTURE, there is not a noticeable change even when contrast is increased with a bright picture or reduced with a dark picture.

Helpful Hint (NORMALIZE Normalization)

While the "PICTURE" menu is displayed, if the OK button is pressed during "NORMALIZE", then all adjustment values are returned to the factory settings.

ADVANCED SETTINGS

Enables fine picture adjustment at a professional level.

Notes:

- The adjustment values are memorized separately for each input terminal.
- The adjustment range values should be used as an adjustment reference.



● **BLACK EXTENSION** Adjusts the dark shades of the image in gradation.



● **INPUT LEVEL** Adjustment of parts which are extremely bright and hard to see.



● **GAMMA** Available setting values vary depending on "PICTURE MENU" settings and the type of input signal, as follows.

PICTURE MENU	S CURVE	1.0	2.0	2.2	2.5	2.6
STANDARD	—	○*3	○	○	○	○*1
DYNAMIC	○	○*3	○	○	—	○*1
CINEMA	—	○*3	○	○	○*2	○
MONITOR	—	○*3	○	○	—	○



*1 When 2k1k signals are received with the Dual Link HD-SDI Terminal Board (TYFB11DHD), GAMMA "2.6" can also be selected.

*2 When 60 Hz signals are received, GAMMA "2.5" can also be selected.

*3 When 2k1k signals are received with the Dual Link HD-SDI Terminal Board (TY-FB11DHD), GAMMA "1.0" cannot be selected.

● **AGC** Increases the brightness of dark signal automatically.



● **"W/B" adjustment**

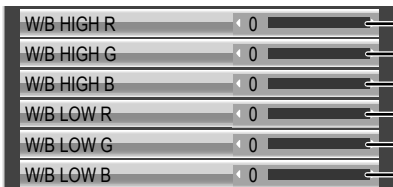

Adjusts the white balance for light red, light green or light blue areas.

Adjusts the white balance for dark red, dark green or dark blue areas.



Carry out "W/B" adjustment as follows.

1. Adjust the white balance of the bright sections using the "W/B HIGH R", "W/B HIGH G" and "W/B HIGH B" settings.
2. Adjust the white balance of the dark sections using the "W/B LOW R", "W/B LOW G" and "W/B LOW B" settings.
3. Repeat steps 1 and 2 to adjust.

Steps 1 and 2 affect each other's settings, so repeat each step in turn to make the adjustment.

PICTURE Adjustments

- 3:2 PULLDOWN** When "ON", the display attempts to reproduce a more natural interpretation of sources such as movie pictures, which are recorded at 24 frames per second. If the picture is not stable, turn the setting to "OFF".

OFF  ON

Note:

When "ON", this setting only affects the following signal input:

- 525i (480i), 625i (575i), 1125 (1080) / 60i signal input during "COMPONENT" input signal.

- STUDIO GAIN** Sharpens the contrast for a better view when a part of the image is too light to see.

OFF  ON

OFF: Disables "STUDIO GAIN".
ON: Enables "STUDIO GAIN".

Notes:

- "STUDIO GAIN" can be modified when "Studio mode" in the OPTIONS menu is "On". When "Studio mode" is "Off", this setting is "OFF" and cannot be changed. (see page 42)
- This setting is valid only when the input signals are as follows:
Component Video, RGB (analog), SDI, HDMI

- NOISE REDUCTION** Sets the following three NR (Noise Reduction) functions together.
 VIDEO NR, MOSQUITO NR, BLOCK NR

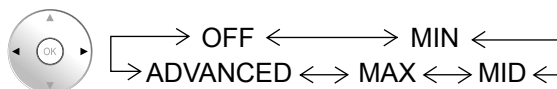

[Advanced NR]

Sets the three NR functions separately.

1 Select "ADVANCED".

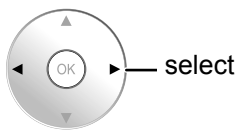

2 Select the item and set.

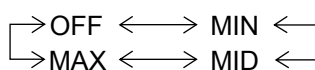
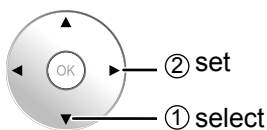
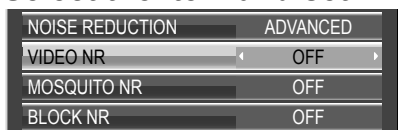

- VIDEO NR:** Automatically reduces unwanted picture noise.
- MOSQUITO NR:** Reduces mosquito noise around subtitles on MPEG videos.
- BLOCK NR:** Reduces block noise when playing MPEG videos.

Notes:

- "NOISE REDUCTION" cannot be adjusted while a PC signal is being applied.
- "BLOCK NR" cannot be adjusted while a HD signal is being applied.

Helpful Hint (NORMALIZE Normalization)

On the remote control unit, while the "ADVANCED SETTINGS" menu is displayed, if the OK button is pressed during "NORMALIZE", then all adjustment values are returned to the factory settings.

Picture Profiles

Up to 16 combinations of picture adjustment values (in the PICTURE menu and ADVANCED SETTINGS) can be stored in the display memory as profiles and applied as needed, for a convenient way to enjoy your preferred picture settings.

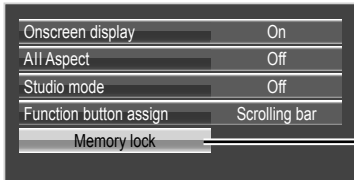
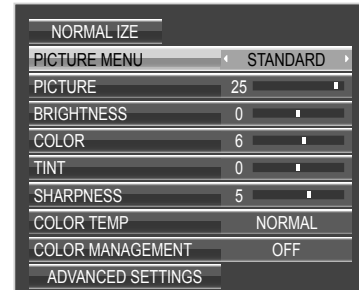

Save profiles



Save the picture adjustment values in the MEMORY1 profile

Edit the profile
Delete or rename the profile

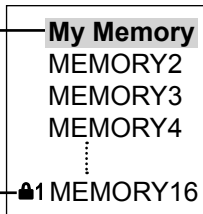

Locked profile — MEMORY16

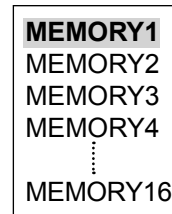

Load the profile



Apply the MEMORY1 profile

Original picture



Custom picture

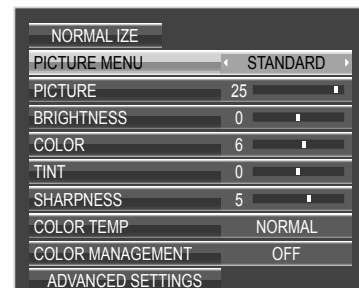
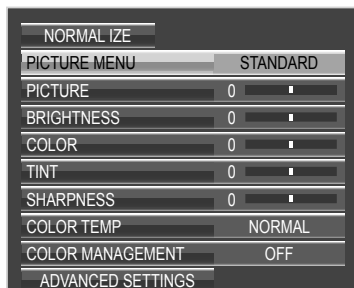

Saving profiles

Follow these steps to save picture adjustment values as profiles.

- 1 Specify the picture quality in the PICTURE menu and ADVANCED SETTINGS. (see page 21-24)

- 2 In the PICTURE menu, select "MEMORY SAVE".



- 3 Select a profile name for saving the picture adjustment values.

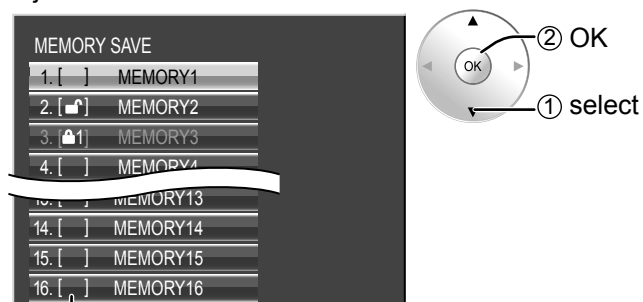

Profiles are labeled with these icons to indicate their locked status. (see page 27)

[], [🔒]: Settings can be saved in this profile.

[🔒1], [🔒2]: Settings cannot be saved in this profile.

- 4 Select "OK".

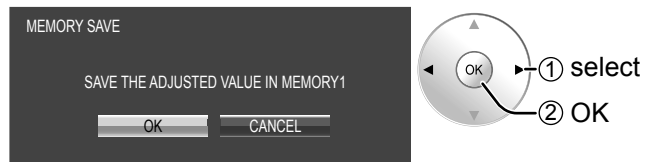

- 5 Enter a name for the profile.

[Entering profile names]

Profile names can be up to 16 characters.

To enter text, select characters in the on-screen keyboard.

Edit the default profile name in the text box as desired.

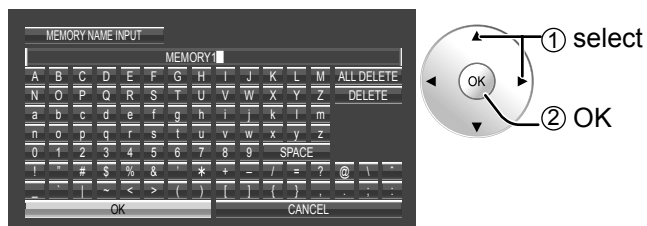

Example: Specifying "MY PICTURE"

- 1 Select "ALL DELETE".

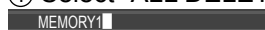

All text is deleted.

To delete individual characters, select "DELETE".

- 2 Select "M".

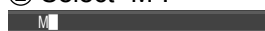

Repeat this process to enter the next character.

- 3 Select "Y".



- 4 Select "SPACE".



- 6 When you finished entering the profile name, select "OK".

To cancel saving the profile, select "CANCEL".

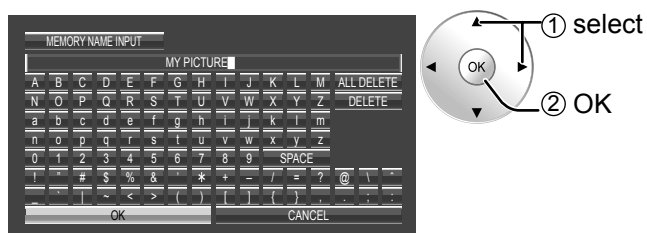

Loading profiles

Load profiles and apply the picture adjustment values to the display as follows.

Note:

Loaded profiles are stored in memory according to the selected input interface (SLOT1, 2, 3 or PC IN).

<Loading profiles from the PICTURE menu>

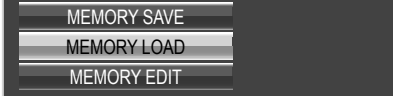
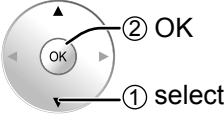
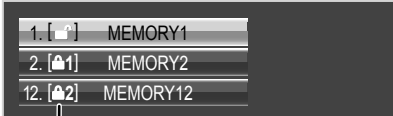
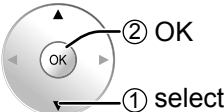
- In the PICTURE menu, select "MEMORY LOAD".

- Select the profile to load.

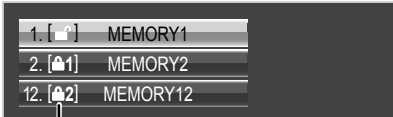
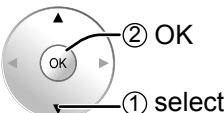

Profiles are labeled with these icons to indicate their locked status. (see below)

<Loading profiles from MEM. LOAD on the remote control>

- Press **MEM. LOAD** to list the profiles.

- Select the profile to load.

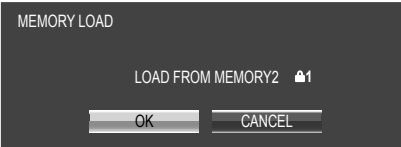
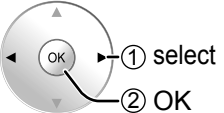

Profiles are labeled with these icons to indicate their locked status. (see below)

<Loading profiles directly from the remote control>

- To load profiles 1–9
- Press a button in the range **1–9**.

 - Select "OK".



To load profiles 10–16
 Example: To load profile 16

- Press **MEM. LOAD** **16**.

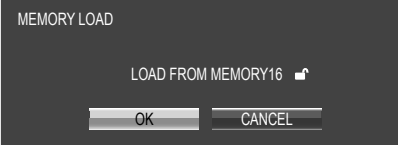
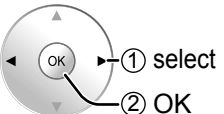
The profile number is displayed in the upper-right corner of the screen.



- Select "OK".

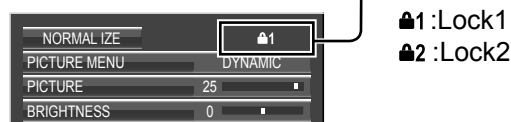

Loading locked profiles...

In the PICTURE menu, profiles are labeled with these icons to indicate their locked status.



Operations with locked profiles are restricted. (see page 29)

Picture adjustment values in the PICTURE menu cannot be changed, except for the "PICTURE MENU".

Once you edit the "PICTURE MENU" setting, you can edit "PICTURE", "BRIGHTNESS", and other picture adjustment values.

Lock1

Picture adjustment values are shown.

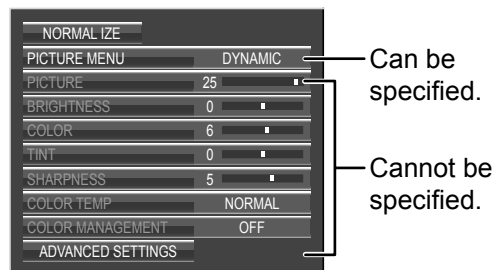

Lock2

Picture adjustment values are hidden.

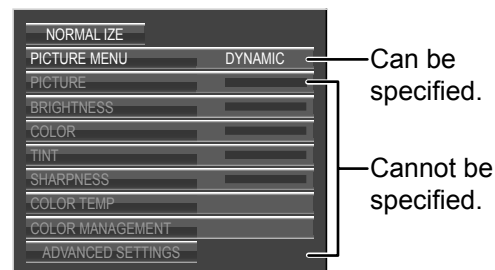

Editing profiles

Delete or rename profiles as follows.

<Deleting profiles>

Note:

Locked profiles and profiles currently in use cannot be deleted.

- 1** In the PICTURE menu, select "MEMORY EDIT".

- 2** Select "MEMORY DELETE".

- 3** Select the profile to delete. To delete all profiles, select "ALL DELETE".

- 4** Select "OK".

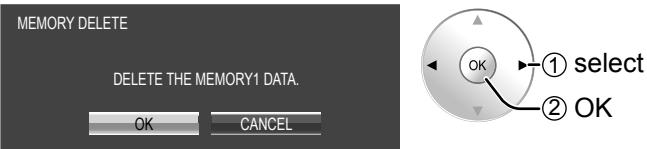



<Renaming profiles>

Note:

Locked profiles cannot be renamed.

- 1** In the PICTURE menu, select "MEMORY EDIT".

- 2** Select "MEMORY NAME CHANGE".

- 3** Select the profile to rename.

- 4** Enter a name for the profile. Entering profile names → page 26

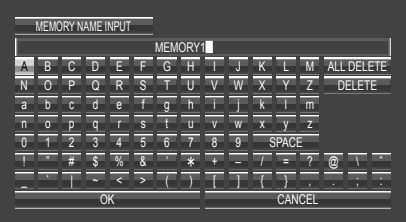





- 5** When you finished entering the profile name, select "OK". To cancel renaming the profile, select "CANCEL".

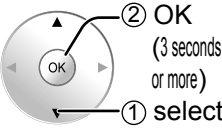
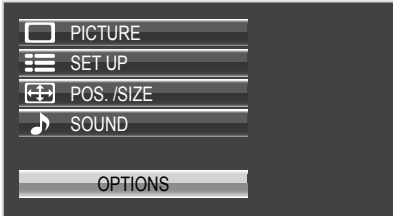

Locking profiles

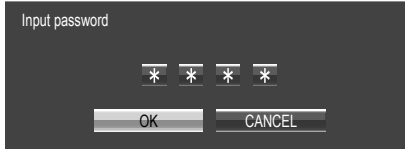
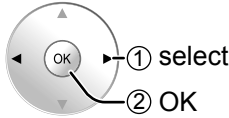
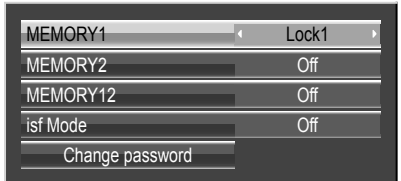
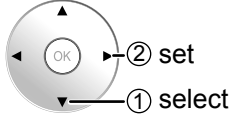
You can lock saved profiles to restrict operations when the profiles are loaded. You can also set passwords.





<Locking and unlocking profiles>

- 1 Display the menu screen. 
- 2 Select "OPTIONS" and hold **OK** for 3 seconds or more. 
- 3 Select "Memory lock". 
- 4 Enter a 4-digit password. The default password is "0123". 
- 5 Select "OK".  
- 6 Select the profile and specify the desired lock setting.  
- 7 Exit the menu.  or 

Once a profile is locked, the following operations are restricted when the profile is loaded.

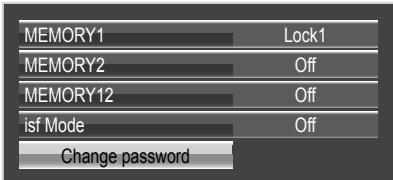
Setting	Editing the Profile (MEMORY EDIT)	Editing Picture Adjustment Values via the Menu (PICTURE menu, ADVANCED SETTINGS)	Saving Picture Adjustment Values (MEMORY SAVE)
Off (unlocked)	Allowed	Allowed	Allowed
Lock1	Prohibited	Prohibited (picture adjustment values are shown)	Allowed
Lock2	Prohibited	Prohibited (picture adjustment values are hidden)	Prohibited

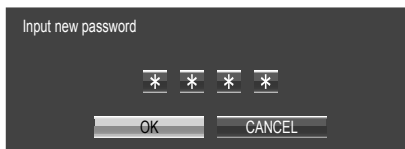
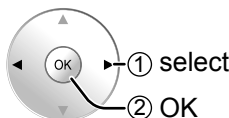
<Changing passwords>

- 1 Follow steps 1–5 in the previous procedure, <Locking and unlocking profiles>.
- 2 Select "Change password". 
- 3 Enter a new 4-digit password. 
- 4 Select "OK".  
- 5 Exit the menu.  or 

Note:
Make a note of the new password to remember it.

Picture Profiles

<isf Mode Setting>

Switches to "PICTURE MENU" mode display.

1 Follow steps 1–5 in the previous procedure, <Locking and unlocking profiles>.

2 Select "isf Mode".

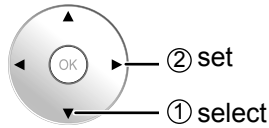
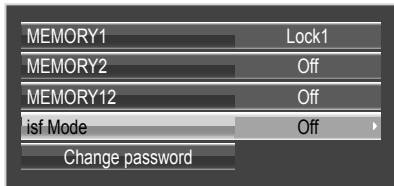

3 Specify "On" or "Off".

4 Exit the menu.



Specifying "On" for isf Mode changes the "PICTURE MENU" mode display as follows.

"PICTURE menu" mode display



isf Mode: Off	isf Mode: On
STANDARD	STANDARD
DYNAMIC	isf Mode DAY
CINEMA	isf Mode NIGHT
MONITOR	MONITOR

Mode display when VIDEO MENU is selected



isf Mode: Off	isf Mode: On
PICTURE MENU STANDARD	PICTURE MENU STANDARD
DYNAMIC	isf Mode DAY
CINEMA	isf Mode NIGHT
MONITOR	MONITOR

Adjusting POS. /SIZE

1 Display the menu screen.



2 Select "POS. /SIZE".

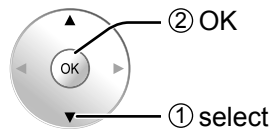
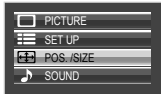

3 Select the item and set.

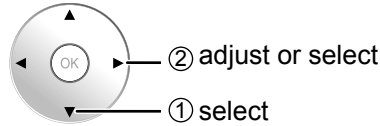
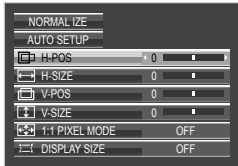

4 Exit the menu.



During "Digital", "SDI" and "HDMI" input signal.

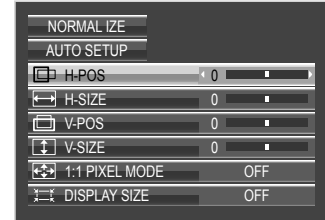

During "COMPONENT", "RGB" and "PC" input signal.

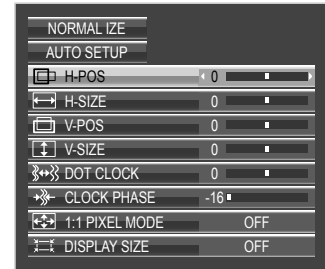

Using **POS./SIZE** for menu display
To display a menu for adjustment of the POS. /SIZE menu on the bottom of the screen, press **POS./SIZE**

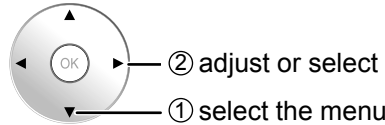

To hide the menu, press **POS./SIZE** or **RETURN**

Notes:

- Unadjustable items are grayed out.
- Adjustable items differ depending on the input signal and the display mode.
- Adjustment details are memorized separately for different input signal formats. (Adjustments for component signals are memorized for 525 (480) / 60i · 60p, 625 (575) / 50i · 50p, 1125 (1080) / 60i · 50i · 60p · 50p · 24p · 25p · 30p · 24sF, 1250 (1080) / 50i, 750 (720) / 60p · 50p each, and RGB/PC/Digital signals are memorized for each frequency.)
- If a "Cue" or "Rew" signal from a VCR or DVD player is received, the picture position will shift up or down. This picture position movement cannot be controlled by the POS. /SIZE function.

• AUTO SETUP

Automatically adjust H-POS / V-POS / CLOCK PHASE / DOT CLOCK and set H-SIZE / V-SIZE the standard value when RGB signal is input.

Notes:

- If the dot clock frequency is 162 MHz or higher, DOT CLOCK cannot be made.
- If the image is that the edge is hardly figured out or shadowy, that cannot be adjusted automatically. In such case, press AUTO SETUP again after changing the image to the clearer one.
- When DVI-D is input, CLOCK PHASE cannot be adjusted automatically.
- Select NORMALIZE in POS. /SIZE and press the OK button when appropriate adjustment cannot be made.

• **H-POS** Adjust the horizontal position.

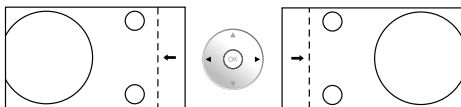

• **V-POS** Adjust the vertical position.

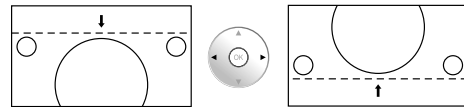

• **H-SIZE** Adjust the horizontal size.

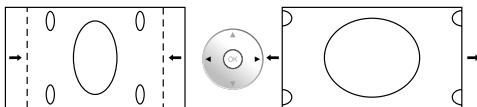

• **V-SIZE** Adjust the vertical size.

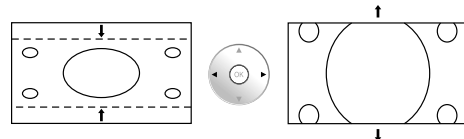

Adjusting POS. /SIZE

- **DOT CLOCK** (During “COMPONENT”, “RGB” and “PC” input signal)
Periodic striped pattern interference (noise) may occur when a striped pattern is displayed. If this happens, adjust so that any such noise is minimized.

- **CLOCK PHASE** (During “COMPONENT”, “RGB” and “PC” input signal)
Eliminate the flickering and distortion.

- **1:1 PIXEL MODE** Adjusts the display size when 1125i, 1125p or 1250i signal is input.
Notes:
 - Select ON when you would like to replay 1920 × 1080 input signal.
 - Applicable input signal;
1125 (1080) / 50i · 60i · 24sF · 24p · 25p · 30p · 50p · 60p, 1250 (1080) / 50i
 - Select OFF when flickering is shown around the image.
 - H-SIZE, V-SIZE and DOT CLOCK cannot be adjusted when ON is selected.

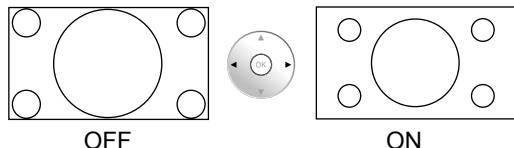

- **1:1 PIXEL MODE (2k1k)** When the input signal is a 2k1k signal (2048×1080 / 24p, 2048×1080 / 24sF), the display size is adjusted as follows.

(For 2k1k signals)

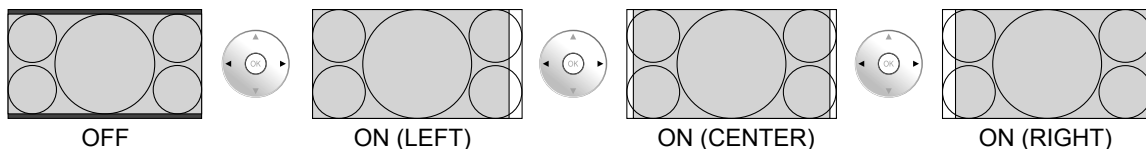

Note:

2k1k signals can only be received when the Dual Link HD-SDI Terminal Board (TY-FB11DHD) is installed.

- **DISPLAY SIZE** Adjusts the image display size on screen.
OFF: Sets the normal image display size on screen.
ON: Sets the image display size approximately 95 % of the normal image display.

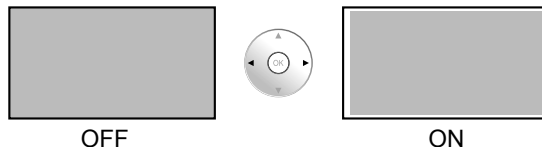

Notes:

- “DISPLAY SIZE” can be modified when “Studio mode” in the OPTIONS menu is “On”. When “Studio mode” is “Off”, this setting is “OFF” and cannot be changed. (see page 42)
- This setting is valid only when the input signals are as follows;
525i, 525p, 625i, 625p, 750/60p, 750/50p, 1125/60i, 1125/50i, 1125/24sF, 1125/25p, 1125/24p, 1125/30p, 1125/60p, 1125/50p, 1250/50i (Component Video, RGB, DVI, SDI, HDMI)
- When “DISPLAY SIZE” is set to “ON”, “H-POS” and “V-POS” in “POS. /SIZE” can be adjusted.
- Refer to each board’s operating instruction for DVI, SDI, HDMI’s corresponding signals.

Helpful Hint (NORMALIZE Normalization)

While the POS. /SIZE display is active, if the OK button is pressed during “NORMALIZE”, then all adjustment values are returned to the factory settings.

SOUND Adjustment

1 Display the menu screen.



2 Select "SOUND"

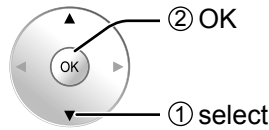
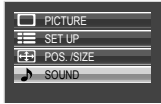

3 Select the item and set.

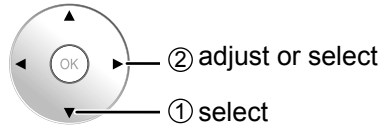

4 Exit the menu.



Item	Details
AUDIO MENU	STANDARD: Emits the original sound. DYNAMIC: Accentuates sharp sound. CLEAR: Attenuates human voice.
BASS	Adjusts low pitch sounds.
MID	Adjusts normal sounds.
TREBLE	Adjusts pitch sound.
BALANCE	Adjusts left and right volumes.
SURROUND	Select ON or OFF. The benefits of surround sound are enormous. You can be completely enveloped in sound; just as if you were at a concert hall or cinema.
VOLUME	Adjust the sound volume level.

Note: BASS, MID, TREBLE and SURROUND settings are memorized separately for each AUDIO MENU.

Helpful Hint (NORMALIZE Normalization)

While the "SOUND" menu is displayed, if the OK button is pressed during "NORMALIZE", then all adjustment values are returned to the factory settings.

SDI SOUND OUTPUT

This menu is displayed when HD-SDI Terminal Board with audio (TY-FB10HD) or Dual Link HD-SDI Terminal Board (TY-FB11DHD) is installed to the unit.

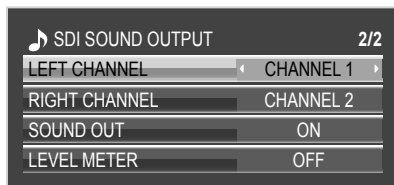

Note:

This menu is available only when selecting a slot that HD-SDI Terminal Board with audio (TY-FB10HD) or Dual Link HD-SDI Terminal Board (TY-FB11DHD) is installed.

Item	Details
LEFT CHANNEL	CHANNEL 1 to CHANNEL 16 Selects left audio channel.
RIGHT CHANNEL	CHANNEL 1 to CHANNEL 16 Selects right audio channel.
SOUND OUT	ON ↔ OFF ON: Enables audio output. OFF: Disables audio output.
LEVEL METER	OFF ↔ 1-8CH ↔ 9-16CH Sets audio channels to show in the audio level meter. 8 channels are displayed in the audio level meter; 4 channels each on both right and left sides of the display. OFF: Hides the audio level meter. 1-8CH: Displays the audio level meter (1-8ch) 9-16CH: Displays the audio level meter (9-16ch)

SCREENSAVER (For preventing image retention)

Do not display a still picture, especially in 4:3 mode, for any length of time. If the display must remain on, a SCREENSAVER should be used.

1 Display the menu screen.



2 Select "SET UP".

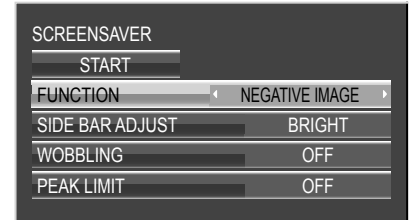
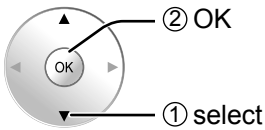
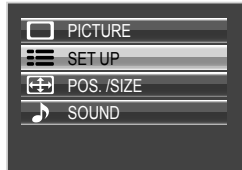

3 Select "SCREENSAVER".

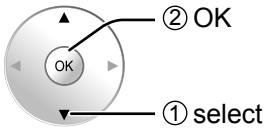
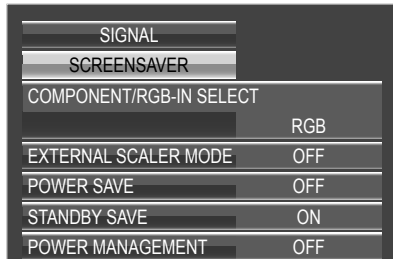

4 FUNCTION selection

Select "FUNCTION" and select the desired function.

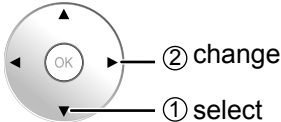
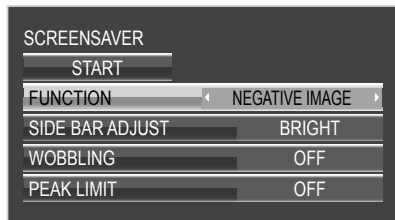

> NEGATIVE IMAGE <-> SCROLLING BAR ONLY <->
 > WHITE SCREEN <-> OVERLAY SCROLLING BAR <->

NEGATIVE IMAGE : A negative image will be displayed on the screen.

SCROLLING BAR ONLY: A white bar will scroll from left to right. The image won't be displayed.

OVERLAY SCROLLING BAR: The brightness of the image will be decreased and a white bar will scroll on it.

WHITE SCREEN : The whole screen will be white.

5 START setting

Select "START".

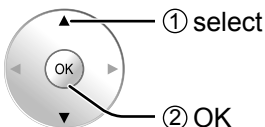
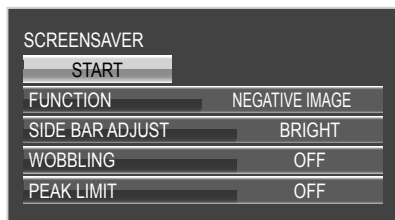

The menu screen will disappear and the SCREENSAVER will be activated. To stop the SCREENSAVER under ON, press **RETURN** or any buttons on the main unit.

Note: When the display is turned off, the SCREENSAVER will be deactivated.

Reduces screen image retention

These functions prevent the occurrence of an “image retention” on the display when turned ON.

WOBLING: Automatically shifts the display image (therefore unnoticeable to the eye) to prevent image retention of sharper contour of image.

ON1: Shifts the image every 30 seconds.

ON2: Shifts the image at a dot level pitch depending on screen-detection.

PEAK LIMIT: Suppresses image contrast (peak brightness).

Note: When a still picture is viewed for an extended time, the screen may become slightly darker. (see page 45)

1 Select “WOBLING” or “PEAK LIMIT”.

2 Select “ON1”, “ON2” or “OFF” (WOBLING).

Select “ON” or “OFF” (PEAK LIMIT).

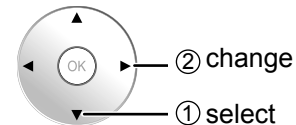
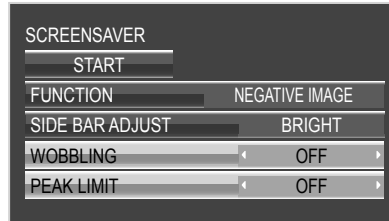

SIDE BAR ADJUST

Do not display a picture in 4:3 mode for an extended period, as this can cause an image retention to remain on the side bars on either side of the display field.

To reduce the risk of such an image retention, illuminate the side bars.

This function may be applicable to the non-picture area.

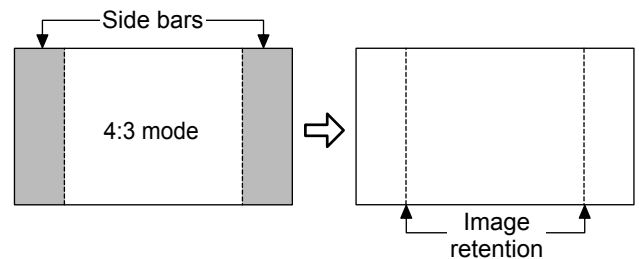

1 Select “SIDE BAR ADJUST”.

2 Adjust the menu.

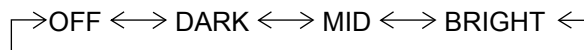
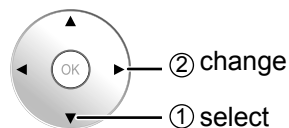
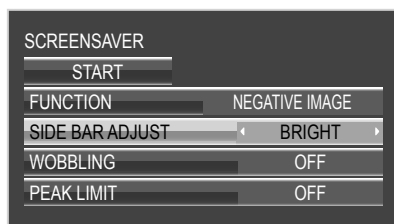

3 Exit from SCREENSAVER.



Notes:

- To reduce the occurrence of image retention, set the “SIDE BAR ADJUST” to “BRIGHT”.
- The side bar may flash (alternate black/white) depending on the picture being shown on the screen. Using Cinema mode will reduce such flashing.

Specifying the scaler

This menu can be used to specify whether the built-in scaler or an external scaler is used for scaler functions such as resizing and picture quality adjustment.

The setting is valid with the following input signals.

1125 (1080) / 24p·25p·30p·50p·60p

1 Display the menu screen.



2 Select "SET UP".

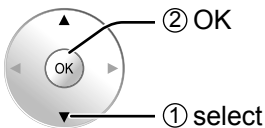
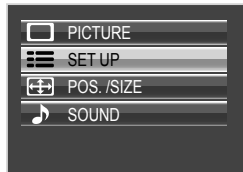

3 Select "EXTERNAL SCALER MODE" and set.

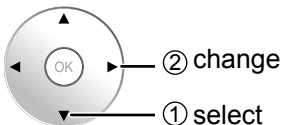
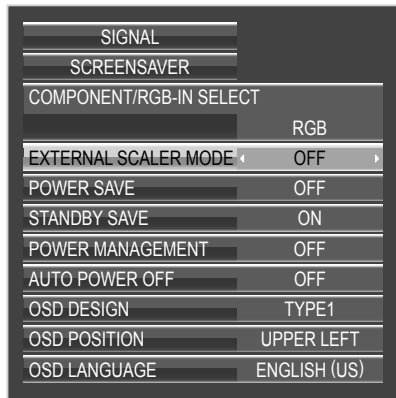

OFF ↔ ON

OFF: Use the built-in scaler.

ON: Use an external scaler.

Note:

Selecting "ON" in this setting deactivates the following settings and disables these operations.

POS. /SIZE menu: H-SIZE, V-SIZE, 1:1 PIXEL MODE, DISPLAY SIZE (see page 31, 32)

PICTURE menu: BRIGHTNESS, COLOR, TINT, SHARPNESS, MEMORY SAVE, MEMORY LOAD (see page 22, 26, 27)

ADVANCED SETTINGS: 3:2 PULLDOWN, NOISE REDUCTION (see page 24)

SIGNAL menu: XGA MODE (see page 40)

OPTIONS menu: All Aspect (see page 42)

ASPECT Controls (see page 18)

"EXT. SCALER" is displayed in the menu screen to indicate that an external scaler is in use.



4 Exit the menu.

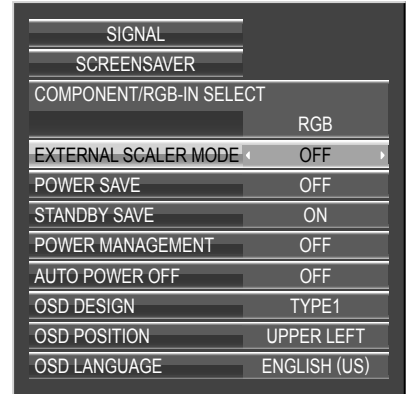

Reduces power consumption

1 Display the menu screen.



2 Select "SET UP".

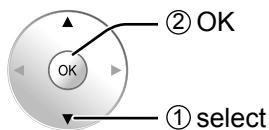
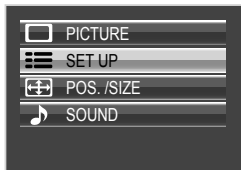

3 Select the item and set.

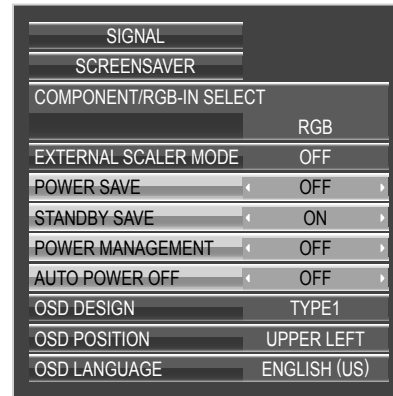
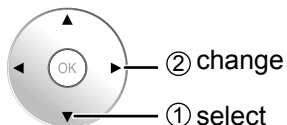
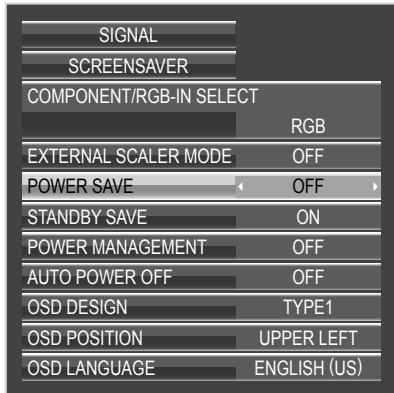

4 Exit the menu.



- **POWER SAVE**

When this function is turned ON, luminous level of the Plasma Display is suppressed, so power consumption is reduced.

- **STANDBY SAVE**

When this function is turned ON, power consumption of the microcomputer is reduced during power supply standby (see page 13, 15, 16), so standby power of the set is reduced.

- **POWER MANAGEMENT**

When this function is set to ON, it operates under the following conditions to turn the power on or off automatically.

When no pictures (HD/VD sync signals) are detected for 30 or so seconds during PC IN signal input:

→Power is turned off (standby); the power indicator lights up orange.

When pictures (HD/VD sync signals) are subsequently detected:

→Power is turned on; the power indicator lights up green.

Notes:

- This function operates only during PC IN signal input.
- This function is effective when "SYNC" is set to "AUTO" and "COMPONENT / RGB-IN SELECT" is set to "RGB".

- **AUTO POWER OFF**

Equipment power supply is turned OFF when there is no signal.

When this is set to On, the power supply of the unit goes Off 10 minutes after the input signals stop.

Note:

- This function is effective for input signals except PC IN terminal.

Customizing the On-Screen Menu Display

Specify the background color and display position of on-screen menus as follows.

1 Display the menu screen.



2 Select "SET UP".

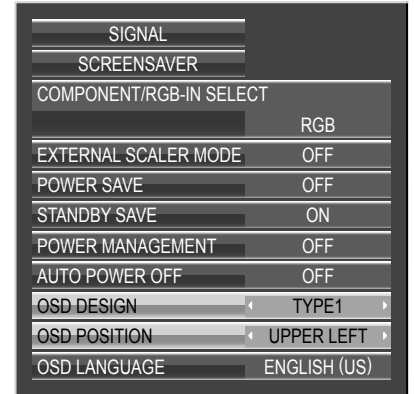
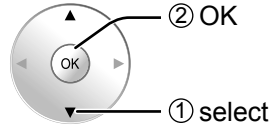
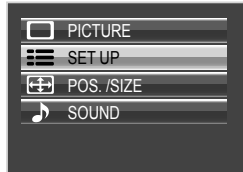

3 Specify the background color.

Select "OSD DESIGN" and choose the background color (transparency).

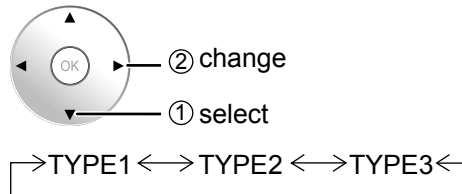
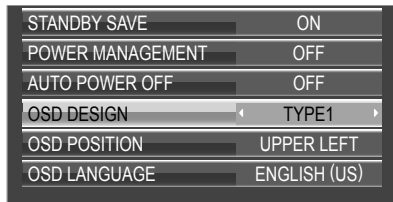

4 Specify the display position.

Select "OSD POSITION" and choose the display position.

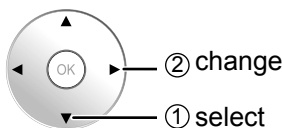
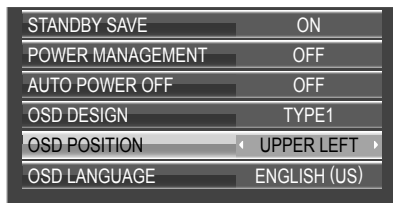

Each time you press ◀ or ▶, the on-screen menu display position changes.

Display example

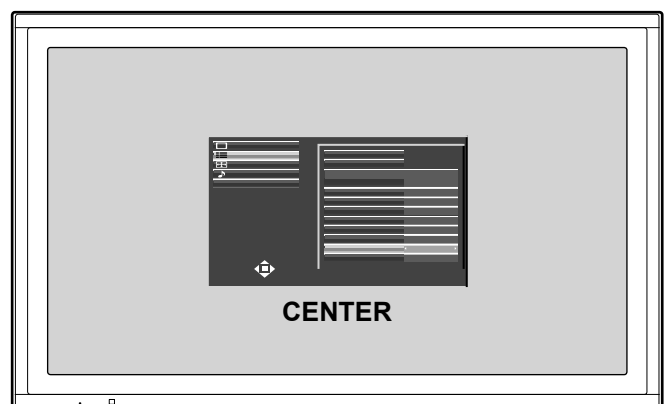
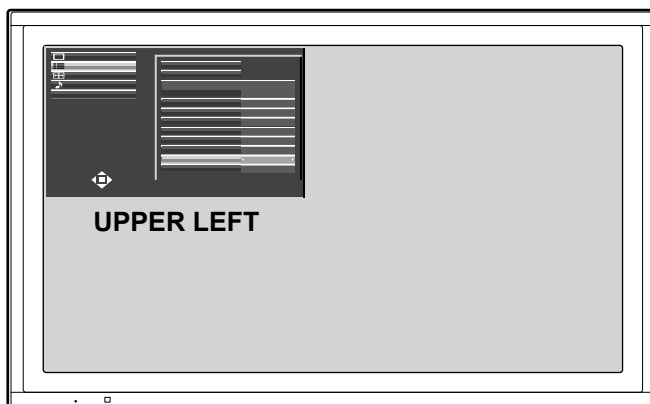

5 Exit the menu.



SET UP for Input Signals

COMPONENT / RGB IN SELECT

Select to match the signals from the source connected to the COMPONENT / RGB input terminals.

Y, P_B, P_R signals → "COMPONENT"

RGB signals → "RGB"

1 Display the menu screen.



2 Select "SET UP".

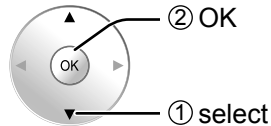
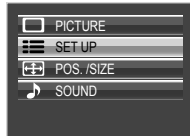

3 Select "COMPONENT / RGB-IN SELECT" and set.

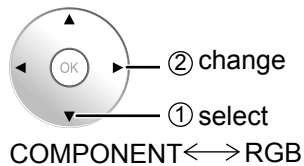
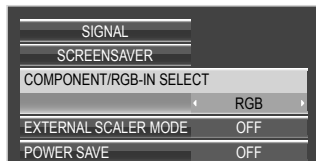

4 Exit the menu.



Notes:

- Selection may not be possible, depending on which optional board is installed.
- Make setting of the selected input terminal (SLOT1, SLOT2, SLOT3 or PC IN).

YUV / RGB IN SELECT

Select to match the signals from the source connected to the DVI input terminals.

YUV signals → "YUV"

RGB signals → "RGB"

1 Display the menu screen.



2 Select "SET UP".

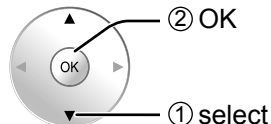
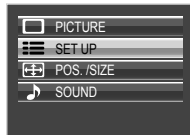

3 Select "YUV / RGB-IN SELECT" and set.

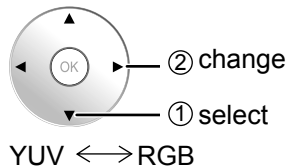
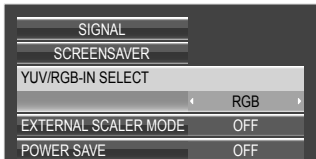

4 Exit the menu.



Notes:

- Selection may not be possible, depending on which optional board is installed.
- Make setting of the selected input terminal (SLOT1 or SLOT2).

SET UP for Input Signals

SIGNAL menu

Note:

“SIGNAL” setup menu displays a different setting condition for each input signal.

The diagram illustrates the navigation from the main SIGNAL menu to specific settings for different input signals. The main menu on the left lists various options, with 'COMPONENT/RGB-IN SELECT' set to 'RGB'. An arrow labeled 'OK' points to three sub-menus:

- For RGB:** SIGNAL [RGB], SYNC AUTO, XGA MODE 1024 × 768, REFRESH RATE 100 Hz, H-FREQ. 33.7 kHz, V-FREQ. 60.0 Hz, SIGNAL FORMAT 1125(1080)/60i.
- For COMPONENT:** SIGNAL [COMPONENT], XGA MODE 1024 × 768, REFRESH RATE 100 Hz, H-FREQ. 33.7 kHz, V-FREQ. 60.0 Hz, SIGNAL FORMAT 1125(1080)/60i.
- For Digital:** SIGNAL [Digital], REFRESH RATE 100 Hz, H-FREQ. 33.7 kHz, V-FREQ. 60.0 Hz, DOT CLOCK-FREQ. 108.0 MHz, SIGNAL FORMAT 1125(1080)/60i.

XGA MODE

This menu is displayed when the input signal is analog (Component/PC). This unit supports three types of XGA signals with 60Hz vertical frequency having different aspect ratios and sampling rates (1,024 × 768 @ 60Hz, 1,280 × 768 @ 60Hz, and 1,366 × 768 @ 60Hz). Be sure to make settings in accordance with the input signal in order to achieve a more appropriate and attractive display.

In addition, after making this setting, be sure to make each adjustment (such as “AUTO SETUP”) on the “POS. /SIZE” menu as necessary. (see page 30)

The diagram shows the XGA MODE menu with the following settings: SIGNAL [COMPONENT], XGA MODE 1024 × 768, REFRESH RATE 100 Hz. To the right, a circular navigation pad is shown with arrows and labels: '1 select' for the center 'OK' button and '2 change' for the right arrow. Below the pad, a horizontal line with arrows indicates the resolution selection sequence: 1024×768 ↔ 1280×768 ↔ 1366×768 ←.

REFRESH RATE

This function sets the refresh rate of the display.

This menu is displayed when the input signal is 50 Hz system (50i, 50p, 25p, 24p, 24sF) of vertical scan rate.

100 Hz: Reduce screen flicker.

50 Hz: Enhance the resolution of moving images.

Note:

It is recommended to set to 100 Hz normally.

The diagram shows the REFRESH RATE menu with the following settings: SIGNAL [COMPONENT], XGA MODE 1024 × 768, REFRESH RATE 100 Hz. To the right, a circular navigation pad is shown with arrows and labels: '1 select' for the center 'OK' button and '2 change' for the right arrow. Below the pad, a horizontal line with arrows indicates the refresh rate selection sequence: 100 Hz ↔ 50 Hz.

SYNC

Select SIGNAL from the "SET UP" menu during RGB input signal.

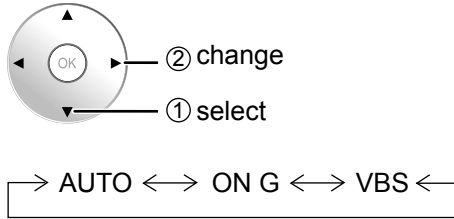

Setting RGB sync signal

Confirm that the input is set to RGB INPUT (this setting is valid only for RGB INPUT signal)

AUTO: The H and V sync or synchronized signal are automatically selected. If both input, it is selected the H and V sync.

ON G: Uses a synchronized signal on the Video G signal, which is input from the G connector.

VBS: Uses a synchronized signal of Composite Sync input, which is input from the HD connector.

SDI THROUGH

Set the active through function of the Dual Link HD-SDI Terminal Board (TY-FB11DHD).

Note:

Settings can only be performed for this menu when a slot mounted with a Dual Link HD-SDI Terminal Board (TY-FB11DHD) is selected.

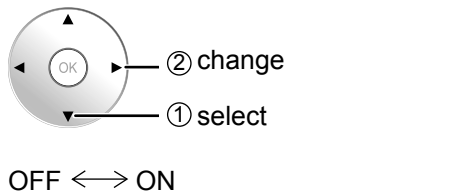

ON: Enables active through.
OFF: Disables active through.

Input signal display

Displays the frequency and the type of the current input signal.

This display is valid only for COMPONENT/RGB/PC and Digital input signal.

Display range:

Horizontal 15 - 110 kHz

Vertical 48 - 120 Hz

The dot clock frequency is displayed during digital signal input.

H-FREQ.	33.7 kHz
V-FREQ.	60.0 Hz
SIGNAL FORMAT	1125(1080)/60i

H-FREQ.	33.7 kHz
V-FREQ.	60.0 Hz
DOT CLOCK-FREQ.	108.0 MHz
SIGNAL FORMAT	1125(1080)/60i

OPTIONS Adjustments

1 Display the menu screen.



2 Select "OPTIONS".

3 Press **OK** for more than 3 seconds.

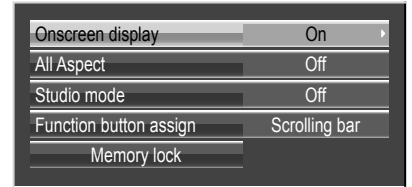
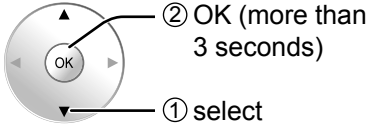

4 Select the item and set.

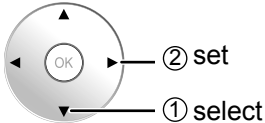
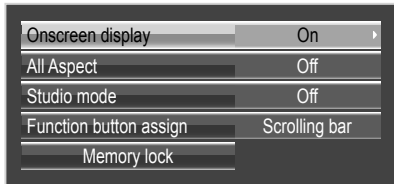

5 Exit the menu.



Item	Adjustments												
Onscreen display	<p>On: Displays all the following on screen.</p> <ul style="list-style-type: none"> • Power on display • Input signal switch display • No signal display • Mute after RECALL was pressed. <p>Off: Hides all the items above from view.</p>												
All Aspect	<p>Sets All Aspect mode (advanced aspect setting) or default aspect mode. With each press of ASPECT button, the aspect changes in the selected mode.</p> <p>Off: Default aspect mode On: All Aspect mode</p> <p>Aspect mode of each setting is as follows: (Example: HD signal) Off 4:3→H-FILL→ZOOM→FULL→JUST On 4:3 (1)→4:3 (2)→4:3 Full→Zoom1→Zoom2→Zoom3→16:9→14:9→Just1→Just2</p>												
Studio mode	<p>For switching functions in setting menus used for television studio applications.</p> <table border="1"> <thead> <tr> <th></th> <th>Studio mode: On</th> <th>Studio mode: Off</th> </tr> </thead> <tbody> <tr> <td>COLOR TEMP</td> <td>"STUDIO" can be selected.</td> <td>"STUDIO" not available.</td> </tr> <tr> <td>STUDIO GAIN</td> <td>Can be switched ON and OFF.</td> <td>Cannot be specified (set to "OFF" and cannot be changed).</td> </tr> <tr> <td>DISPLAY SIZE</td> <td>Can be switched ON and OFF.</td> <td>Cannot be specified (set to "OFF" and cannot be changed).</td> </tr> </tbody> </table>		Studio mode: On	Studio mode: Off	COLOR TEMP	"STUDIO" can be selected.	"STUDIO" not available.	STUDIO GAIN	Can be switched ON and OFF.	Cannot be specified (set to "OFF" and cannot be changed).	DISPLAY SIZE	Can be switched ON and OFF.	Cannot be specified (set to "OFF" and cannot be changed).
	Studio mode: On	Studio mode: Off											
COLOR TEMP	"STUDIO" can be selected.	"STUDIO" not available.											
STUDIO GAIN	Can be switched ON and OFF.	Cannot be specified (set to "OFF" and cannot be changed).											
DISPLAY SIZE	Can be switched ON and OFF.	Cannot be specified (set to "OFF" and cannot be changed).											
Function button assign	<p>Specifies the function activated when the FUNCTION button on the remote control is pressed.</p> <p>Scrolling bar: Activates the SCROLLING BAR ONLY screensaver. After 15 minutes, the display enters standby mode.</p> <p>Test patterns: Each time you press OK, a different test pattern is displayed (seven in all).</p>												
Memory lock	Locks or unlocks saved profiles. Also for setting passwords. (see page 29)												

Watching Videos and DVDs

If you have applicable equipment connected to the Display, you can easily watch videos and DVDs using the Display's remote control.

You can select the external equipment to access.

To operate other manufacturers' equipment, you need to register the code for the equipment. (see page 44)

1 Select the input mode. (see page 14)

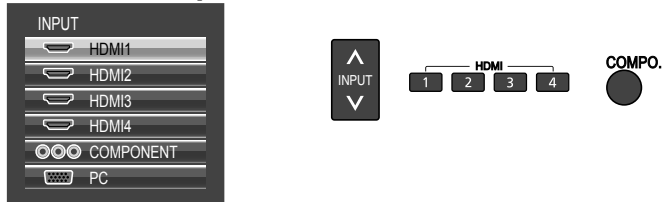

2 Select the remote control mode.

Press the key to select.



3 Operate the connected equipment, pointing Display's remote control at the equipment.

Example

	VCR MODE	DVD MODE
	VCR Record	Record
	—	Skip Reverse/Forward
	Rewind/Fast Forward	Reverse/Forward
	Stop	Stop
	Pause	Pause
	Play	Play

(For other operations, see page 47)

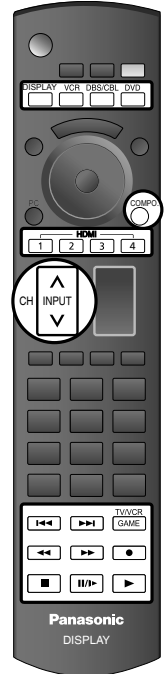

Programming the Remote to Operate Peripheral Equipment

You can operate other manufacturers' equipment using this Display's remote control.

1 Connect the external equipment to the Display and Power Off the external equipment.

2 Press both buttons simultaneously for more than 3 seconds.

Release the buttons when the equipment selection buttons start flashing.

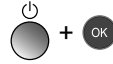

3 Select the equipment.

The selected button remains lit (other buttons are not lit).



4 Input the equipment's 4-digit remote control code.

(see page 48, 49)



5 Operate the equipment with the remote control.

(see page 47)

The external equipment turns On.



Press to return to the Display mode. 

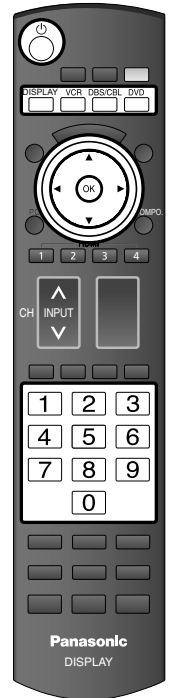

■ If the equipment does not operate with the remote control

- When your equipment has a single code
➔ Input the remote control code again
- When your equipment has multiple codes
➔ Change the code with 4 above and test again

Note:

Registration will fail if the wrong code is input or it takes more than 30 seconds to register.

To find a code not listed in the code list

This procedure searches all codes and is called the "sequence method."

1 After step 3 above, change the code and test.

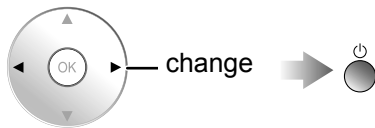

➔ Operate the equipment with the remote control.
(see page 47)





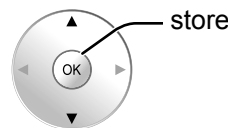





- Repeat until the code is found.
- It may take many attempts before the correct code is found.

2 When the correct code is found.



Troubleshooting

Before you call for service, determine the symptoms and make a few simple checks as shown below.

Symptoms		Checks
Picture	Sound	
 Interference	 Noisy Sound	Electrical Appliances Cars / Motorcycles Fluorescent light
 Normal Picture	 No Sound	Volume (Check whether the mute function has been activated on the remote control.)
 No Picture	 No Sound	Not plugged into AC outlet Not switched on PICTURE and BRIGHTNESS/Volume setting (Check by pressing the power switch or stand-by button on the remote control.)
 No Picture	 Normal Sound	If a signal with a non-applicable color system format, or frequency is input, only the input terminal indication is displayed.
 No Color	 Normal Sound	Color controls set at minimum level. (see page 21- 24)
No remote control operations can be performed.		Check whether the batteries have discharged completely and, if they have not, whether they were inserted properly. Check whether the remote control sensor is exposed to an outdoor light or a strong fluorescent light. Check whether the remote control designed specifically for use with the unit is being used. (The unit cannot be operated by any other remote control.)
A cracking sound is sometimes heard from the unit.		If there is nothing wrong with the picture or sound, this is the sound of the cabinet undergoing very slight contractions in response to changes in the room temperature. There are no adverse effects on the performance or other aspects.
The top or bottom of the picture on the screen is cut off when I use the zoom function.		Adjust the position of the picture on the screen.
Areas at the top and bottom of the screen where the image is missing appear when I use the zoom function.		When using a video software program (such as a cinema size program) with a screen wider than one in the 16:9 mode, blank areas separate from the images are formed at the top and bottom of the screen.
I can hear sounds coming from inside the unit.		When the power is turned on, a sound of the display panel being driven may be heard: This is normal and not indicative of malfunctioning.
This Plasma Display uses special image processing.		Hence a slight time lag may occur between image and audio, depending on the type of input signal. However, this is not a malfunction.

Plasma Display panel

Symptoms	Check
The screen darkens slightly when bright pictures with minimal movements are shown.	The screen will darken slightly when photos, still images of a computer or other pictures with minimal movements are shown for an extended period. This is done to reduce image retention on the screen and the shortening of the screen's service life: It is normal and not indicative of malfunctioning.
It takes a while for the picture to appear.	The unit digitally processes the various signals in order to reproduce esthetically pleasing images. As such, it sometimes takes a few moments for the picture to appear when the power has been turned on, when the input has been switched.
The edges of the images flicker.	Due to the characteristics of the system used to drive the panel, the edges may appear to flicker in the fast-moving parts of the images: This is normal and not indicative of malfunctioning.
The brightness on both sides of images in 4:3 mode changes.	When viewing the side panels at the "BRIGHT" or "MID" setting, the brightness on both sides may change depending on the kind of program shown: This is normal and not indicative of malfunctioning.
Some parts of the screen do not light up.	The plasma display panel is manufactured using an extremely high level of precision technology, however, sometimes some parts of the screen may be missing picture elements or have luminous spots. This is not a malfunction.
 Image retention appears	Do not allow a still picture to be displayed for an extended period, as this can cause a permanent image retention to remain on the Plasma Display. Examples of still pictures include logos, video games, computer images, teletext and images displayed in 4:3 mode. Note: The permanent image retention on the Plasma Display resulting from fixed image use is not an operating defect and as such is not covered by the Warranty. This product is not designed to display fixed images for extended periods of time.
Whirring sounds can be heard from the display unit.	The display unit is fitted with a cooling fan to dissipate heat generated during normal use. The whirring sound is caused by rotation of the fan and is not a malfunction.

List of Aspect Modes

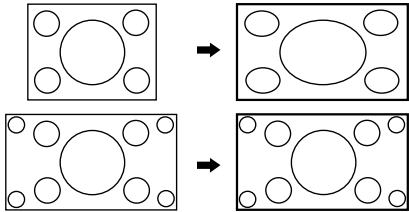
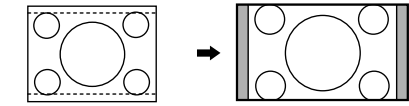
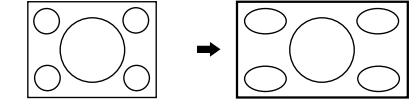
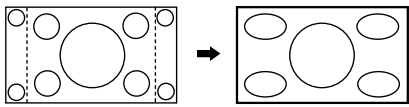
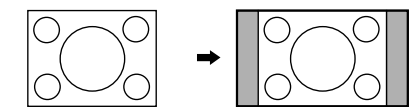
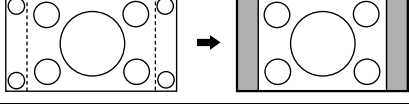
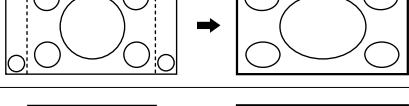
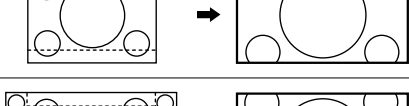
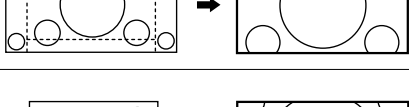
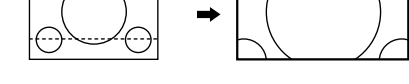
Aspect mode		Picture → Enlarged screen	Description
All Aspect: On	Factory setting All Aspect: Off		
16:9	FULL		The display of the pictures fills the screen. In the case of SD signals, pictures with a 4:3 aspect ratio are enlarged horizontally, and displayed. This mode is suited to displaying anamorphic pictures with a 16:9 aspect ratio.
14:9	–		Letterbox pictures with a 14:9 aspect ratio are enlarged vertically and horizontally so that their display fills the screen vertically and is slightly smaller than the screen horizontally. The top and bottom edges of the pictures are cut off. Side panels are displayed at the left and right edges of the screen.
Just ----- Just1	JUST		Pictures with a 4:3 aspect ratio are enlarged horizontally so that the picture distortion is minimized. The display of the areas around the left and right edges of the screen is slightly elongated.
Just2	JUST		Pictures with a 4:3 aspect ratio are enlarged horizontally so that the picture distortion is minimized. The left and right edges of the pictures are cut off. The display of the areas around the left and right edges of the screen is slightly elongated.
4:3 ----- 4:3 (1)	4:3		Pictures with a 4:3 aspect ratio are displayed with their original aspect ratio. Side panels are displayed at the left and right edges of the screen.
4:3 (2)	4:3		Pictures with a 4:3 aspect ratio are displayed with their original aspect ratio. The left and right edges of the pictures are masked by side panels.
4:3 Full	H-FILL		Pictures with a 4:3 aspect ratio are enlarged horizontally so that their display fills the screen. The left and right edges of the pictures are cut off.
Zoom ----- Zoom1	ZOOM		Letterbox pictures with a 16:9 aspect ratio are enlarged vertically and horizontally so that their display fills the screen. The top and bottom edges of the pictures are cut off.
Zoom2	ZOOM		Letterbox pictures with a 16:9 aspect ratio are enlarged vertically and horizontally so that their display fills the screen. The top and bottom edges as well as the left and right edges of the pictures are cut off.
Zoom3	–		Letterbox pictures with a 2.35:1 aspect ratio are enlarged vertically and horizontally so that their display fills the screen vertically and is slightly larger than the screen horizontally. The top and bottom edges as well as the left and right edges of the pictures are cut off.

Remote Control Operation / Code List

The following explains how to operate external devices with the Display's remote control.

Register the remote control codes (page 44) if you want to operate an external device from another manufacturer. (see page 48, 49)













Note:

Operation may not be possible depending on the available memory size of the remote control.

This remote control is not designed to cover operation of all functions of all models.

Remote Control Operation List

This chart defines which keys are operational after programming (if needed) while in the selected remote control mode, CABLE, DBS, VCR, or DVD.

KEY NAME	VCR MODE	DBS/CBL MODE		DVD MODE
		(DBS)	(CBL)	
	Power	Power	Power	Power
	—	Menu	Menu	Functions
	—	PPV/VOD	PPV/VOD	Return
	—	Up/Down/Left/Right	Up/Down/Left/Right	Up/Down/Left/Right
	—	Select	Select	Enter
	Channel Up/Down	Channel Up/Down	Channel Up/Down	Channel Up/Down
	0-9	0-9	0-9	0-9
	—	Page Down/Up	Page Down/Up	Skip Reverse/Forward
	TV/VCR Switch	TV/DBS Switch	TV/CBL Switch	—
	Rewind/Fast Forward	Rewind/Fast Forward	Rewind/Fast Forward	Reverse/Forward
	Record	Record *1	Record *1	Record
	Stop	Stop	Stop	Stop
	Pause	Pause	Pause	Still/Pause
	Play	Play	Play	Play

*1: Combination type

Remote Control Code List (Continued)

DVD Recorder / Player		DVD Recorder / Player		DVD Recorder / Player		DVD Recorder / Player	
Brand	Code	Brand	Code	Brand	Code	Brand	Code
Accurian	1072, 1416	Fisher	0670	Marantz	0539	Sanyo	0670, 0695, 0873
Advent	1016	Funai	0675, 1268, 1334	Memorex	0695, 0831, 1270	Sensory Science	1158
Aiwa	0641	Gateway	1073, 1077, 1158, 1194	Microsoft	0522, 1708	Sharp	0630, 0675, 0752, 1256
Akai	0695, 0770, 0899, 1089	GE	0522, 0815, 0717	Mintek	0717, 0839	Sharper Image	1117
Alco	0790	Go Video	0715, 0741, 0744, 0783, 0833, 0869, 1044, 1075, 1099, 1158, 1304, 1730	Mitsubishi	0521, 1521	Sherwood	0633, 0770, 1043, 1077
Allegra	0869			Momitsu	1082	Shinonic	0533, 0839
Amphion Media Works	0872			NAD	0741	Sonic Blue	0869, 1099
Apex Digital	0672, 0717, 0755, 0794, 0796, 0797, 0830, 1004, 1020, 1056, 1061, 1100	Go Vision	1071, 1072	NEC	0785	Sony	0533, 0864, 1033, 1070, 1431, 1533
Arrgo	1023	GoldStar	0741	Nesa	0717	Sova	1122
Aspire Digital	1168, 1407	Greenhill	0717	Next Base	0826	Superscan	0821
Audiovox	0790, 1071, 1072, 1121, 1122	Harman/Kardon	0582, 0702	NexxTech	1402	SVA	0860, 1105
Axon	1071, 1072	Hitachi	0573, 0664, 1247	Norcent	0872, 1003, 1107, 1265	Sylvania	0675, 0821, 1268
Blaupunkt	0717	Hiteker	0672	Onkyo	0503, 0627, 0792	Symphonic	0675, 0821
Blue Parade	0571	Humax	1588	OptoMedia Electronics	0896	Teac	0790
Broksonic	0695, 0868	iLo	1348	Oritron	0651	Technics	0490, 0703
Cinea	0831	Initial	0717	Panasonic	0490, 0703, 1362, 1462, 1490, 1762, 1779, 2060, 2061, 2062	Technosonic	0730
CineVision	0833, 0869, 0876	Insignia	1268	Philips	0503, 0539, 0646, 0675, 0854, 1260, 1267, 1354	Theta Digital	0571
Citizen	0695, 1277	Integra	0627	Pioneer	0525, 0571, 0631	Toshiba	0503, 0695, 1045, 1154, 1588, 1769
Coby	0778, 0852, 1086, 1107, 1165, 1177	JBL	0702	Polaroid	1020, 1061, 1086	Trex	0800
Craig	0831	Jensen	1016	Polk Audio	0539	Urban Concepts	0503
Curtis Mathes	1087	JSI	1423	Portland	0770	US Logic	0839
CyberHome	0816, 0874, 1023, 1024, 1117, 1129, 1502	JVC	0558, 0623, 0867, 1164	Presidian	0675, 1072	Venturer	0790
Daewoo	0705, 0784, 0833, 0869, 1169, 1172, 1234, 1242, 1441	jWin	1049	Prima	1016	Vizio	1064, 1226
Denon	0490, 0634	Kawasaki	0790	Proscan	0522	Xbox	0522, 1708
Desay	1407	Kenwood	0490, 0534	ProVision	0778	Yamaha	0490, 0539, 0545
Disney	0675, 1270	KLH	0717, 0790, 1020, 1149	Qwestar	0651	Zenith	0503, 0591, 0741, 0869
Dual	1068, 1085	Konka	0711, 0719, 0720	RCA	0522, 0571, 0717, 0790, 0822, 1022, 1132, 1769	Zoece	1265
Durabrand	1127	Koss	0651, 0896, 1423	Rio	0869	AMW	0872
DVD2000	0521	Landel	0826	Rotel	0623		
Emerson	0591, 0675, 0821, 1268	Lasonic	0798, 1173	Rowa	0823		
Enterprise	0591	Lenoxx	1127	Sampo	0698, 0752		
ESA	0821, 1268	LG	0591, 0741, 0801, 0869	Samsung	0199, 0490, 0573, 0820, 0899, 1044, 1075		
		LiteOn	1058, 1158, 1416, 1440	Sansui	0695		
		Loewe	0511, 0885				
		Magnavox	0503, 0539, 0646, 0675, 0821, 1268				
		Malata	0782, 1159				

Applicable Input Signals

	Signal name	Horizontal frequency (kHz)	Vertical frequency (Hz)	Component / RGB / Mini D-sub 15P (Dot clock (MHz))	DVI-D *8 (Dot clock (MHz))
1	525 (480) / 60i	15.73	59.94	* (13.5)	
2	525 (480) / 60p	31.47	59.94	* (27.0) *5	* (27.0)
3	625 (575) / 50i	15.63	50.00	* (13.5)	
4	625 (575) / 50p	31.25	50.00	* (27.0)	
5	625 (576) / 50p	31.25	50.00		* (27.0)
6	750 (720) / 60p	45.00	60.00	* (74.25)	* (74.25)
7	750 (720) / 50p	37.50	50.00	* (74.25)	* (74.25)
8	1,125 (1,080) / 60p	67.50	60.00	* (148.5) *1	* (148.5)
9	1,125 (1,080) / 60i	33.75	60.00	* (74.25) *1	* (74.25)
10	1,125 (1,080) / 50p	56.26	50.00	* (148.5) *1	* (148.5)
11	1,125 (1,080) / 50i	28.13	50.00	* (74.25) *1	* (74.25)
12	1,125 (1,080) / 24sF	27.00	48.00	* (74.25) *2	
13	1,125 (1,080) / 30p	33.75	30.00	* (74.25) *1	* (74.25)
14	1,125 (1,080) / 25p	28.13	25.00	* (74.25) *1	* (74.25)
15	1,125 (1,080) / 24p	27.00	24.00	* (74.25) *1	* (74.25)
16	1,250 (1,080) / 50i	31.25	50.00	* (74.25) *3	
17	2,048 × 1,080 / 24sF *7	27.00	48.00		
18	2,048 × 1,080 / 24p *7	27.00	24.00		
19	640 × 400 @70 Hz	31.46	70.07	* (25.17)	
20	640 × 480 @60 Hz	31.47	59.94	* (25.18) *6	* (25.18)
21	640 × 480 @72 Hz	37.86	72.81	* (31.5)	
22	640 × 480 @75 Hz	37.50	75.00	* (31.5)	
23	640 × 480 @85 Hz	43.27	85.01	* (36.0)	
24	800 × 600 @56 Hz	35.16	56.25	* (36.0)	
25	800 × 600 @60 Hz	37.88	60.32	* (40.0)	* (40.0)
26	800 × 600 @72 Hz	48.08	72.19	* (50.0)	
27	800 × 600 @75 Hz	46.88	75.00	* (49.5)	
28	800 × 600 @85 Hz	53.67	85.06	* (56.25)	
29	852 × 480 @60 Hz	31.47	59.94	* (33.54) *6	* (34.24)
30	1,024 × 768 @50 Hz	39.55	50.00		* (51.89)
31	1,024 × 768 @60 Hz	48.36	60.00	* (65.0)	* (65.0)
32	1,024 × 768 @70 Hz	56.48	70.07	* (75.0)	
33	1,024 × 768 @75 Hz	60.02	75.03	* (78.75)	
34	1,024 × 768 @85 Hz	68.68	85.00	* (94.5)	
35	1,066 × 600 @60 Hz	37.64	59.94	* (53.0)	* (53.0)
36	1,152 × 864 @60 Hz	53.70	60.00		* (81.62)
37	1,152 × 864 @75 Hz	67.50	75.00	* (108.0)	
38	1,280 × 768 @60 Hz	47.70	60.00	* (80.14)	
39	1,280 × 960 @60 Hz	60.00	60.00	* (108.0)	
40	1,280 × 960 @85 Hz	85.94	85.00	* (148.5)	
41	1,280 × 1,024 @60 Hz	63.98	60.02	* (108.0)	* (108.0)
42	1,280 × 1,024 @75 Hz	79.98	75.03	* (135.0)	
43	1,280 × 1,024 @85 Hz	91.15	85.02	* (157.5)	
44	1,366 × 768 @50 Hz	39.55	50.00		* (69.92)
45	1,366 × 768 @60 Hz	48.36	60.00	* (86.71)	* (87.44)
46	1,400 × 1,050 @60 Hz	65.22	60.00		* (122.61)
47	1,600 × 1,200 @60 Hz	75.00	60.00	* (162.0)	* (162.0)
48	1,600 × 1,200 @65 Hz	81.25	65.00	* (175.5)	
49	1,920 × 1,080 @60 Hz	67.50	60.00	* (148.5) *4	* (148.5)
50	1,920 × 1,200 @60 Hz	74.04	59.95		* (154.0)
51	Macintosh13" (640 × 480)	35.00	66.67	* (30.24)	
52	Macintosh16" (832 × 624)	49.72	74.54	* (57.28)	
53	Macintosh21" (1,152 × 870)	68.68	75.06	* (100.0)	

*1: Based on SMPTE 274M standard.

*2: Based on SMPTE RP211 standard.

*3: Based on SMPTE 295M standard.

*4: The input signal is recognized as 1,125 (1,080) / 60p.

*5: When selected the RGB format and 525p signal input to the Mini D-sub 15P terminal, it is recognized as VGA 60Hz signal.

*6: When inputted VGA 60Hz format signal from the other than Mini D-sub 15P terminal, it is recognized as 525p signal.

*7: Based on SMPTE 292M and 372M standards. These signals can be received when the Dual Link HD-SDI Terminal Board (TY-FB11DHD) is installed.

*8: These signals can be received when the DVI-D Terminal Board (TY-FB11DD) is installed.

Note: Signals without above specification may not be displayed properly.

VIDEO input (HDMI)

	Signal format	Vertical frequency (Hz)	Horizontal frequency (kHz)	Dot clock (MHz)	Number of active pixels	Total number of pixels	Number of active lines	Total number of lines
1	VGA60	59.94	31.47	25.18	640	800	480	525
2	525/60p	59.94	31.47	27.00	720	858	480	525
3	625/50p	50.00	31.25	27.00	720	864	576	625
4	750/60p	60.00	45.00	74.25	1280	1650	720	750
5	750/50p	50.00	37.50	74.25	1280	1980	720	750
6	1125/60i	60.00	33.75	74.25	1920	2200	1080	1125
7	1125/50i	50.00	28.13	74.25	1920	2640	1080	1125
8	1125/60p	60.00	67.50	148.50	1920	2200	1080	1125
9	1125/50p	50.00	56.26	148.50	1920	2640	1080	1125
10	1125/24p	24.00	27.00	74.25	1920	2750	1080	1125

Audio signal Linear PCM : 48/44.1/32 kHz

Specifications

	TH-50VX100U	TH-65VX100U
Power Source	110 - 127 V AC, 50/60 Hz	
Power Consumption		
Power on	605 W	755 W
Stand-by condition	Save OFF 0.9 W, Save ON 0.5 W	Save OFF 1.0 W, Save ON 0.5 W
Power off condition	0.1 W	0.2 W
Plasma Display panel	Drive method : AC type 50-inch, 16:9 aspect ratio	Drive method : AC type 65-inch, 16:9 aspect ratio
Screen size	43.5" (1,106 mm) (W) × 24.4" (622 mm) (H) × 49.9" (1,269 mm) (diagonal)	56.4" (1,434 mm) (W) × 31.7" (807 mm) (H) × 64.7" (1,646 mm) (diagonal)
(No. of pixels)	2,073,600 (1,920 (W) × 1,080 (H)) [5,760 × 1,080 dots]	
Operating condition		
Temperature	32 °F - 104 °F (0 °C - 40 °C)	
Humidity	20 % - 80 %	
Applicable signals		
Scanning format	525 (480) / 60i · 60p, 625 (575) / 50i · 50p, 750 (720) / 60p · 50p, 1125 (1080) / 60i · 60p · 50i · 50p · 24p · 25p · 30p · 24sF, 1250 (1080) / 50i	
PC signals	VGA, SVGA, XGA, SXGA UXGA ··· (compressed) Horizontal scanning frequency 15 - 110 kHz Vertical scanning frequency 48 - 120 Hz	
Connection terminals		
HDMI A-B	TYPE A Connector × 4	
COMPONENT/RGB IN	Y/G (RCA PIN JACK) P _B /B, P _R /R (RCA PIN JACK) AUDIO IN (RCA PIN JACK × 2)	with sync 1.0 Vp-p (75 Ω) 0.7 Vp-p (75 Ω) 0.5 Vrms
PC IN	(HIGH-DENSITY MINI D-SUB 15PIN) AUDIO IN (M3 JACK)	Y or G with sync 1.0 Vp-p (75 Ω) Y or G without sync 0.7 Vp-p (75 Ω) B/P _B /C _B : 0.7 Vp-p (75 Ω) R/P _R /C _R : 0.7 Vp-p (75 Ω) HD/VD: 1.0 - 5.0 Vp-p (high impedance) 0.5 Vrms
SERIAL	EXTERNAL CONTROL TERMINAL (D-SUB 9PIN)	RS-232C COMPATIBLE
Speaker terminal	6 Ω, 16 W [8 W + 8 W] (10 % THD)	8 Ω, 20 W [10 W + 10 W] (10 % THD)
Accessories Supplied		
Remote Control Transmitter	N2QAYB000323	
Batteries	AA Size × 2	
Fixing band	TMME203 × 1	
Dimensions (W × H × D)	47.7" (1,210 mm) × 28.5" (724 mm) × 3.7" (93 mm)	61.2" (1,554 mm) × 36.4" (924 mm) × 3.8" (94 mm)
Mass (weight)	approx. 81.6 lbs	approx. 152.2 lbs

Note:

Design and specifications are subject to change without notice. Mass and dimensions shown are approximate.

(for the U.S.A and Puerto Rico)

Panasonic Professional Display Company
Unit of Panasonic Corporation of
North America
One Panasonic Way 1F-10
Secaucus, NJ 07094

**Panasonic Professional Flat Panel Display
Limited Warranty**

Panasonic Professional Display Company. (referred to as “the Warrantor”) will repair this product and all included accessories with new or refurbished parts, free of charge in the USA or Puerto Rico, of the original purchase in the event of a defect in materials or workmanship as follows:

Models or Parts	Part Warranty	Labor Warranty
Professional Flat Panel Display	2 Years	2 Years

On-site or carry-in service in the **USA and Puerto Rico** may be obtained during the warranty period by contacting Panasonic Professional Display Company Service toll free at 1-800-973-4390.

This warranty is extended only to the original purchaser and is non transferable. A purchase receipt or other proof of date of original purchase will be required before warranty service is rendered.

This warranty only covers failures due to defects in materials or workmanship, which occur during normal use. The warranty does not cover damage which occur in shipment, or failures which are caused by products not supplied by the warrantor, or failures which result from improper installation, set-up adjustments, improper

antenna, inadequate signal pickup, maladjustment of consumer controls, improper operation, power line surge, improper voltage supply, lighting damage, or service by anyone other than an authorized repair facility, or damage that is attributable to acts of God.

LIMITS AND EXCLUSIONS

There are no express warranties except as listed above.

THE WARRANTOR SHALL NOT BE LIABLE FOR INCIDENTAL OR CONSEQUENTIAL DAMAGES (INCLUDING, WITHOUT LIMITATION, DAMAGE TO DISCS) RESULTING FROM THE USE OF THIS PRODUCT, OR ARISING OUT OF ANY BREACH OF THE WARRANTY. ALL EXPRESS AND IMPLIED WARRANTIES, INCLUDING THE WARRANTIES OF MERCHANTABILITY AND FITNESS FOR PARTICULAR PURPOSE, ARE LIMITED TO THE APPLICABLE WARRANTY PERIOD SET FORTH ABOVE.

Some states do not allow the exclusion or limitation of incidental or consequential damages, or limitations on how long an implied warranty lasts, so the above exclusions or limitations may not apply to you. This warranty gives you specific legal rights and you may have other rights, which vary from state to state.

If you have a problem with this product that is not handled to your satisfaction, then write the Consumer Affairs Department at the Company address indicated above.

In the USA and Puerto Rico
FOR SERVICE
CALL TOLL FREE
1-800-973-4390

Panasonic Canada Inc.
5770 Ambler Drive, Mississauga, Ontario L4W 2T3
LIMITED WARRANTY STATEMENT

Panasonic Canada Inc. (also known as PCI) warrants this product to be free of defects in material and workmanship under normal use during the applicable warranty coverage period described below. PCI agrees to repair, or at its option, exchange, any part that becomes defective. However, the product must be purchased and serviced in Canada. The product or part that shows evidence of defect must be delivered prepaid or carried in to an authorized Panasonic Broadcast Service Center. This warranty does not cover shipping costs.

The warranty coverage period is one year for both parts and labour beginning with the date of original end user purchase, subject to the exceptions as stated below. Repaired or replacement parts supplied during the warranty coverage period carry the unexpired portion of the original warranty coverage period. Proof of product purchase is a condition of warranty service. The owner must produce the product purchase receipt or other satisfactory evidence of date of original purchase.

This warranty does not apply to external appearance items, such as handles, knobs, safety windows, etc. This warranty does not apply to any part, or parts, of the product, installed, altered, repaired or misused in any way that, in the opinion of PCI, affects the reliability of or detracts from the performance of the product.

For products requiring routine preventive maintenance, that maintenance must be performed in order to maintain warranty coverage.

Serial numbers that have been altered, defaced or removed void this warranty. This warranty does not cover replacements or repairs necessitated by loss or damage resulting from any cause beyond the control of PCI.

Marking or retained images (sometimes called "burn-in") resulting from the display of fixed images on video display products are not defects and are not covered under this warranty.

THIS EXPRESS, LIMITED WARRANTY IS IN LIEU OF ALL OTHER WARRANTIES, EXPRESS OR IMPLIED, INCLUDING ANY IMPLIED WARRANTIES OF MERCHANTABILITY AND FITNESS FOR A PARTICULAR PURPOSE. IN NO EVENT WILL PANASONIC CANADA INC. BE LIABLE FOR ANY SPECIAL, INDIRECT OR CONSEQUENTIAL DAMAGES.

In certain instances, some jurisdictions do not allow the exclusion or limitation of incidental or consequential damages, or the exclusion of implied warranties, so the above limitations and exclusions may not be applicable.

WARRANTY COVERAGE PERIOD EXCEPTIONS

Item	Parts	Labour
Video Tape	30 days—Replacement only (content not covered)	N/A
P2/SD Cards	(Content not covered)	N/A
Video Heads	1 year or 2,000 hrs. (prorated) Whichever comes first	1 year or 2,000 hrs. Whichever comes first
D5 Video heads	1 year or 1,000 hrs. Whichever comes first	1 year or 1,000 hrs. Whichever comes first
Maintenance Items	90 days	90 days
Colour Camera CCD Imaging Block	2 years	1 year
BT-H Series LCD Monitors	2 years	1 year
* DLP™ Projectors	3 years or 17,000 hrs. Whichever comes first	3 years or 17,000 hrs. Whichever comes first
* LCD Projectors above 2,500 ANSI Lumens	3 years or 2,500 hrs. Whichever comes first	3 years or 2,500 hrs. Whichever comes first.
* LCD Projectors below 2,500 ANSI Lumens	3 years or 1,500 hrs. Whichever comes first	3 years or 1,500 hrs. Whichever comes first
Projector Lamps	50% of the rated lamp life or 1 year. Whichever comes first	50% of the rated lamp life or 1 year. Whichever comes first.
103 inch Plasma displays	3 year (burn-in not covered)	3 year
Hard Drive Disk Unit	1 year plus balance (if any) of the original Manufacturer's Limited Warranty. (Content not covered)	1 year

- * Dust, smoke, rental/staging environment and twenty-four/seven operation, dramatically decreases the interval between performances of routine preventive maintenance required to maintain this warranty coverage.

Warranty Service

If the product needs to be shipped for service, carefully pack (preferably in the original carton) and enclose a letter, detailing the complaint. Send prepaid and adequately insured to the local authorized Panasonic Service Centre in your area or to Panasonic Technical Support and Product Services Department, 5770 Ambler Drive, Mississauga, Ontario, L4W 2T3. Shipping to the latter location requires a return authorization before shipment. No liability is assumed for loss or damage to the product while in transit.

Customer Service

Customer Service Directory

Obtain information products and operative assistant; localize the closer distributor or Service Center; buy spare parts and accessories by our web site to Latin American:

<http://www.lar.panasonic.com>

Also you may contact us directly by our Contact Center:

Panama	800-PANA (800-7262)
Colombia	1-8000-94PANA (1-8000-947262) - National Line 635-PANA (635-7262) - Bogota Line
Ecuador	1800-PANASONIC (1800-726276)
Costa Rica	800-PANA737 (800-7262737)
El Salvador	800-PANA (800-7262)
Guatemala	1-801-811-PANA (1-801-811-7262)
Chile	800-260602 From a cell phone: 245-2520
Venezuela	800-PANA-800 (800-7262-800)
Uruguay	0-800-PANA (0800-7262)

Mexico Service

To obtain information in the Republic of Mexico contact us at:

[email: atencion.clientes@mx.panasonic.com](mailto:atencion.clientes@mx.panasonic.com)

Or you may contact us in the next following phones numbers:

01800-VIP-PANA (01800-847-7262) - Interior
(55) 5000-1200 - Mexico D.F. and Metropolitan Area

Customer's Record

The model number and serial number of this product can be found on its back cover. You should note this serial number in the space provided below and retain this book, plus your purchase receipt, as a permanent record of your purchase to aid in identification in the event of theft or loss, and for Warranty Service purposes.

Model Number _____

Serial Number _____

© Panasonic Corporation 2008

Panasonic Professional Display Company

Unit of Panasonic Corporation of North America

Executive Office :

One Panasonic Way 1F-10, Secaucus, NJ 07094

EASTERN ZONE : One Panasonic Way 4E-7 Secaucus, NJ 07094 (201) 348-7621

Mid-Atlantic/New England : One Panasonic Way 4E-7 Secaucus, NJ 07094 (201) 348-7621

Southeast Region : 1225 Northbrook Parkway, Ste 1-160 Suwanee GA 30024 (770)338-6835

Central Region : 1707 N Randall Road E1-C-1, Elgin, IL 60123 (847)468-5200

WESTERN ZONE : 3330 Cahuenga Blvd W., Los Angeles, CA 90068 (323) 436-3500

Dallas Region : 6226 Abington Way, Houston, TX 77008 (713) 802-2726

No. CA/Northwest Region : 5870 Stone Ridge, #3, Pleasanton, CA (925) 416-5108

Government Marketing Department : 52 West Gude Drive, Rockville, MD 20850 (301) 738-3840

Panasonic Canada Inc.

5770 Ambler Drive

Mississauga, Ontario

L4W 2T3

Printed in Japan
PBS1108S1128

Free Manuals Download Website

<http://myh66.com>

<http://usermanuals.us>

<http://www.somanuals.com>

<http://www.4manuals.cc>

<http://www.manual-lib.com>

<http://www.404manual.com>

<http://www.luxmanual.com>

<http://aubethermostatmanual.com>

Golf course search by state

<http://golfingnear.com>

Email search by domain

<http://emailbydomain.com>

Auto manuals search

<http://auto.somanuals.com>

TV manuals search

<http://tv.somanuals.com>