

Owner's Manual



Pelican
Water Systems



Pelican PSE1800/PSE2000 Premium Whole House Water Filter Filter & Salt Free Water Softener/Conditioner Combo

© Copyright 2013 Enviro Water Solutions Inc. All rights reserved.

All information contained herein is the property of Pelican Water Systems. Pelican Water Systems makes no warranty of any kind with regard to this material, including, but not limited to, the implied warranties of merchantability and fitness for a particular purpose. Pelican Water Systems shall not be liable for technical or editorial errors or omissions contained herein or for incidental or consequential damages in connection with the furnishing, performance, or use of this material. The information is provided "as is" without warranty of any kind and is subject to change without notice. This document contains proprietary information which is protected by copyright. No part of this document may be photocopied, reproduced, or translated into another language without the prior written consent of Pelican Water Systems. Pelican Water Systems is an Enviro Water Solutions, Inc. company.

Table of Contents

Table of Contents	3
Product Operation and Specifications	4
Important Information	4
Water Conditions for Operation	4
Complete Parts List	5
Installation Overview	6
Pre-Installation	6
Bypass Valve Installation	6
Carbon Tank Soak	7
Carbon Tank Wash	8
Installation	9
Pre-Filter Assembly	9
Pre-Filter Installation	9
Whole House Water Filter Tank Installation	10
Whole House Salt Free Water Softener/Conditioner Tank Installation	11
Media Soak	12
Media Flush/Condition	12
Complete the Installation	13
Clean your Hot Water Heater (optional)	13
What to Expect with your New Salt Free Water Softener/Conditioner	14
Care and Cleaning	16
Premium Whole House Water Filter	16
Sediment Filter	16
Replacing the Sediment Filter	16
Troubleshooting	17
Warranty	19
Warranty Registration Form	20
Product Certifications	21

Product Operation and Specifications

Specification Description	PSE1800	PSE2000
Max Flow Rate	10 GPM	15 GPM
Minimum Working Pressure	25 PSI	
Maximum Working Pressure	80 PSI	
Maximum Vacuum	5 inch/127 mm Hg	
Operating Temperatures	36°F – 120°F	
pH Range	7 - 11	

Important Information

- Read these instructions carefully and determine the location of all system components before beginning installation.
- Check all applicable plumbing, building, and electrical codes for installation compliance.
- Install the system on the main water supply.
- Systems that contain electronic components cannot be installed outside in uncovered areas.

Water Conditions for Operation

- The water should be free of hydrogen sulfide, a dissolved gas with a characteristic smell of rotten eggs. If present, it can coat the catalytic surface of the media and interfere with the process. The gas should be removed through adequate pre-treatment.
- The water should be free of hydrocarbons, oils, and lubricants. If present, they can coat the catalytic surface of the media and interfere with the process. Remove through adequate pre-treatment.
- The water should contain less than 1 mg/l of phosphates. Phosphates sequester dissolved hardness molecules preventing them from forming crystals and may coat the catalytic media surface and interfere with the process.
- The copper level in the water supply should be below the MCL of 1.3mg/L. If copper is present above this level, it can attach to the surface of the catalytic media and interfere with the process.

WARNING:

If this or any other system is installed in a metal (conductive) plumbing system, i.e. copper or galvanized metal, the plastic components of the system will interrupt the continuity of the plumbing system. As a result any errant electricity from improperly grounded appliances downstream or potential galvanic activity in the plumbing system can no longer ground through contiguous metal plumbing. Some homes may have been built in accordance with building codes, which actually encouraged the grounding of electrical appliances through the plumbing system. Consequently, the installation of a bypass consisting of the same material as the existing plumbing, or a grounded "jumper wire" bridging the equipment and re-establishing the contiguous conductive nature of the plumbing system must be installed prior to your systems use.





CAUTION:

When adding a filtration/softening system to homes/buildings supplied by well water, the system should be installed following the pressure tank. **DO NOT USE this system for pneumatic or hydro pneumatic applications. If you are using a booster pump, then install this system following the booster pump.** If you have questions, please call customer service.

Complete Parts List

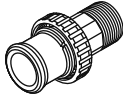
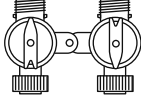
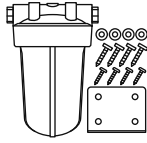
Note: Pelican supplies the parts below to accommodate a variety of water supply lines.

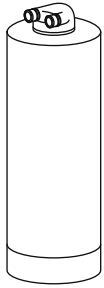
Table 1: Parts List

Part	Description	Qty.	Part	Description	Qty.
	1" Plastic Male NPT Assembly: V3007-04 WS1 Fitting 1" Plastic Male NPT Assembly (2): O-Rings (2), Split Rings (2), and Connectors (2)	2		Bypass Valve: In/Out Bypass Valve with Red Arrow Handles	2
	Pre-Filter System: PP5 Big Blue Pre-Filter Housing, Mounting Bracket, Phillips Head Screws (4), Bolt Head Screws (4), and Washers (4)	1		Hose Bib Assembly	1
	Sediment Filter: PC40-1 5 Micron Poly-Spun Sediment Filter	1		Pelican Whole House Water Filter	1
	Pre-Filter Wrench	1		Pelican Salt Free Water Softener/Conditioner	1
	Non-Abrasive Auto Wax 4 oz. Bottle	1			

Note: Drawings are not to scale.

Additional fittings will be needed to adapt to your plumbing.

Installation Overview

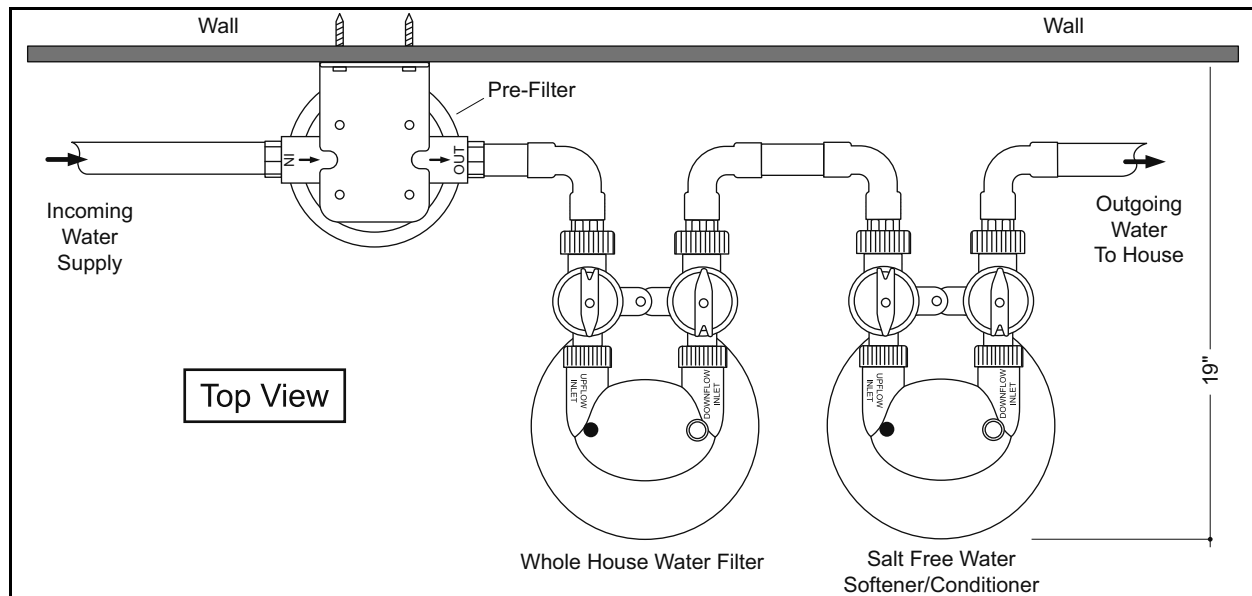

Figure 1

Pre-Installation

Bypass Valve Installation

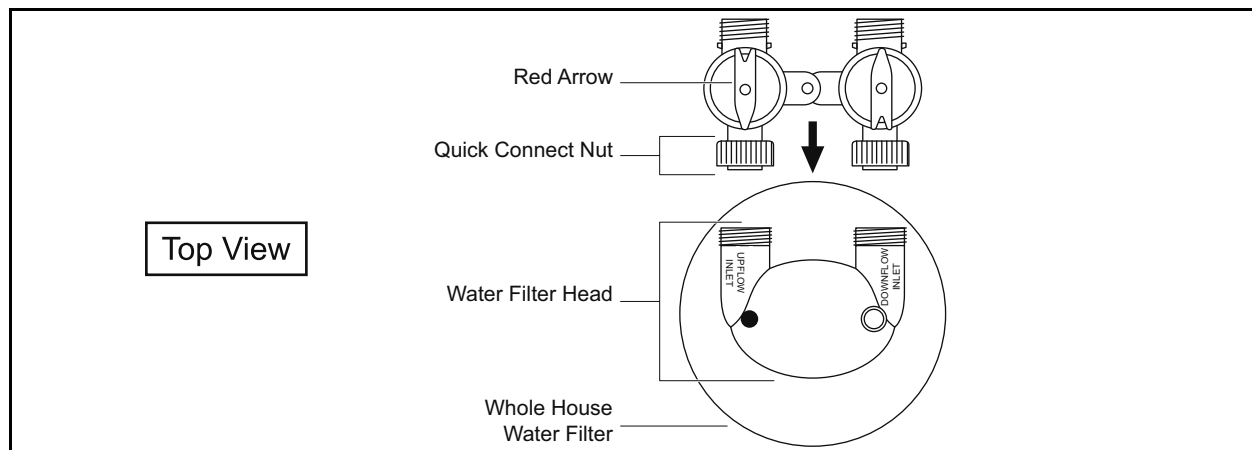

Figure 2

The Bypass Valve comes pre-assembled and ready to install with the O-Rings, Split Rings, and Quick Connect Nuts. Push the Bypass Valve into the head of both the Pelican Whole House Water Filter and Salt Free Water Softener/Conditioner with the unthreaded ends oriented toward the tanks and hand-tighten the Quick Connect Nuts.

Notice:

The bypass valve(s) included with this system are designed for multiple Pelican water systems. This may result in the arrows on the bypass valve(s) pointing differently than shown. If the arrows on your bypass valve(s) do not match the diagram, remove the red arrows by pulling them straight up, turn them 180° to match the drawing, and push them back down onto the stem.

Carbon Tank Soak

!!IMPORTANT!

Your system will not be ready for use for a minimum of 48 hours while the Carbon Soak process takes place. Please plan your installation accordingly.



Notice:

Water will flow out of the downflow inlet side of the Bypass Valve during this process. Be sure you perform this series of steps in a location suitable for water flow.

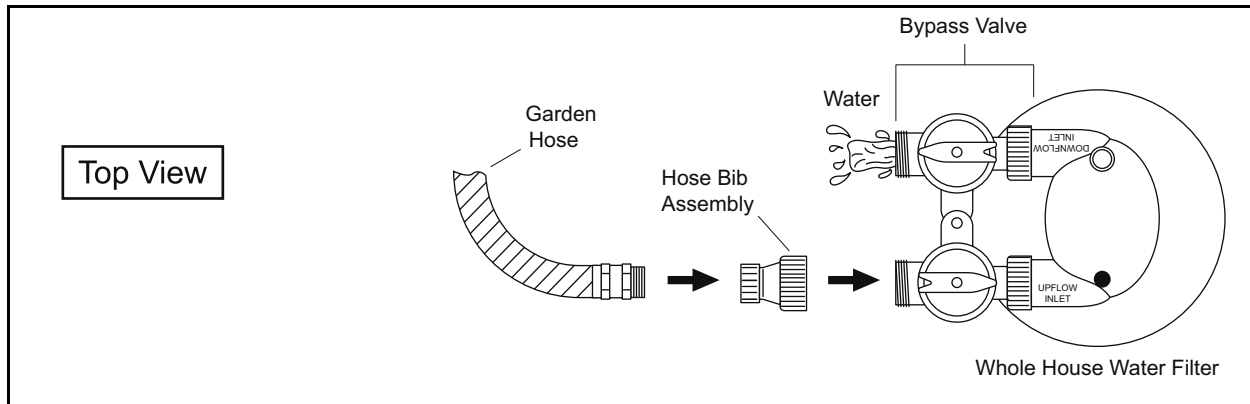

Figure 3

1. Attach a garden hose to the Hose Bib Assembly
2. Connect the Hose Bib Assembly to the upflow inlet side of the Bypass Valve and hand tighten
3. Fill the Pelican Whole House WaterFilter Tank full until water comes out of downflow inlet side of the Bypass Valve
4. Turn the water off.
5. Remove the garden hose from the Hose Bib Assembly. Do not remove the fitting.
6. Allow the carbon tank to soak for at least 48 hours prior to tank installation.

Carbon Tank Wash

!!IMPORTANT!!

Do not perform the Carbon Tank Wash until the Carbon Tank Soak process is complete.



Notice:

Water will flow out of the downflow inlet side of the Bypass Valve during this process. Be sure you perform this series of steps in a location suitable for water flow.

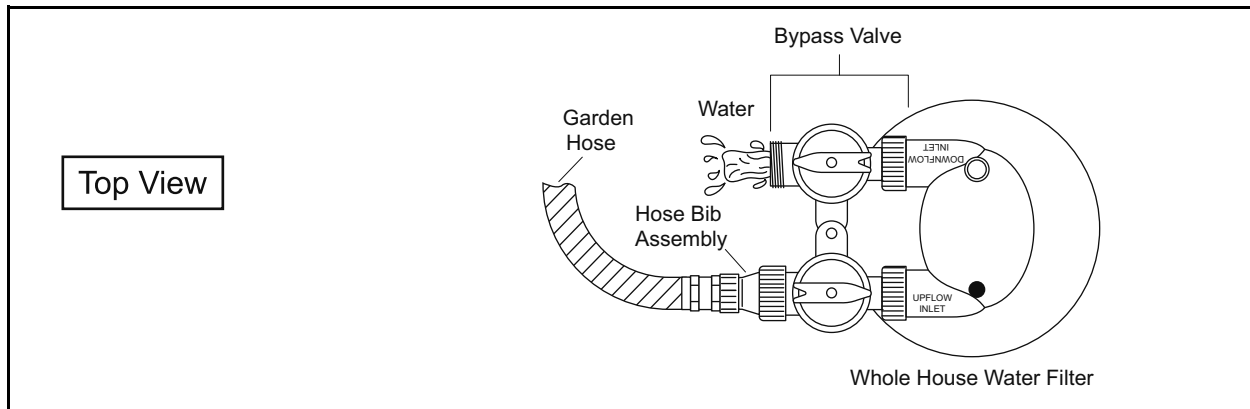

Figure 4

1. Reattach the garden hose to the Hose Bib Assembly.
2. Slowly turn on the water 1/4 turn for this entire process.
3. Run water through the upflow inlet side of the Bypass Valve for 15-30 minutes or until the water discharging from the downflow inlet side of the Bypass Valve runs clear.
4. Turn off the water.
5. Remove the Hose Bib Assembly from the upflow inlet side and attach it to the downflow inlet side of the Bypass Valve.
6. Run the water through the downflow inlet side for 1 minute or until water runs clear.
7. Turn off the water.
8. Remove the Hose Bib Assembly from the Bypass Valve and disconnect the garden hose.

Note: Please save the Hose Bib Assembly as this will be used in the future for the carbon exchange.

Installation

Pre-Filter Assembly

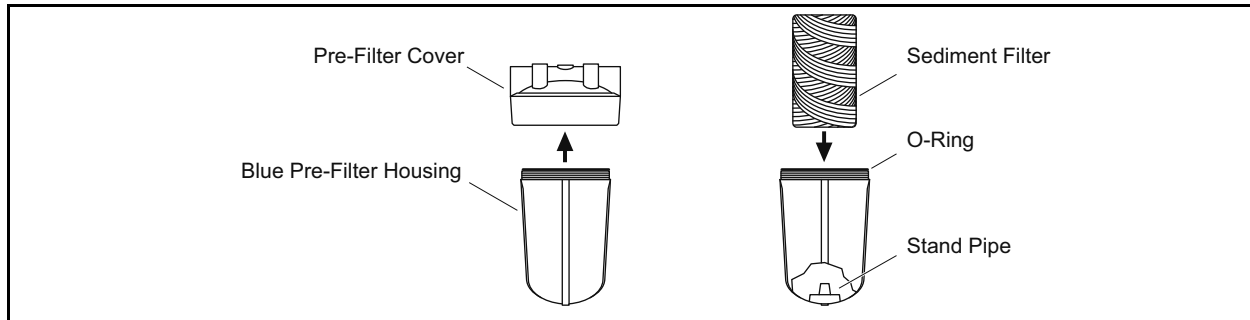

Figure 5

1. Unscrew the cover from the Blue Pre-Filter Housing.
2. Remove the plastic covering from the Sediment Filter.
3. Place the Sediment Filter onto the Stand Pipe in the Blue Pre-Filter Housing.
4. Screw the cover onto the Blue Pre-Filter Housing until hand-tight.

Pre-Filter Installation

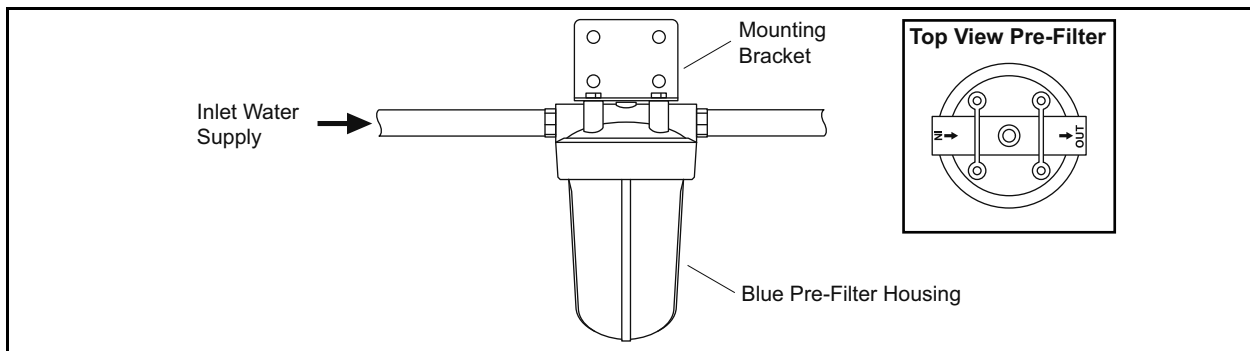

Figure 6

1. Shut off the water.
2. Attach the Mounting Bracket to the wall using the supplied Phillips Head Screws and Washers.
3. Attach the Pre-Filter System to the Mounting Bracket using the supplied Bolt Head Screws.
4. Lube the o-ring with clean silicone grease before attaching the cover onto the housing.
5. Tighten the Blue Pre-Filter Housing using the supplied Pre-Filter Wrench (counter clockwise).
6. Determine the size of your inlet water supply line. PVC Reducers may be needed to fit the 1" Pre-Filter System.



Notice:

The Pre-Filter Housing comes with a 1" threaded female inlet/outlet and will require additional fittings to adapt to your plumbing. A shut-off valve is recommended prior to the Pre-Filter System.

Whole House Water Filter Tank Installation

1. Level the Pelican Whole House Water Filter.



Notice:

If the tank is not level, lift the tank straight up 6 inches and tap it on the ground until the tank stands vertical. The bottom of the tank is round and the boot allows the tank to stand upright.

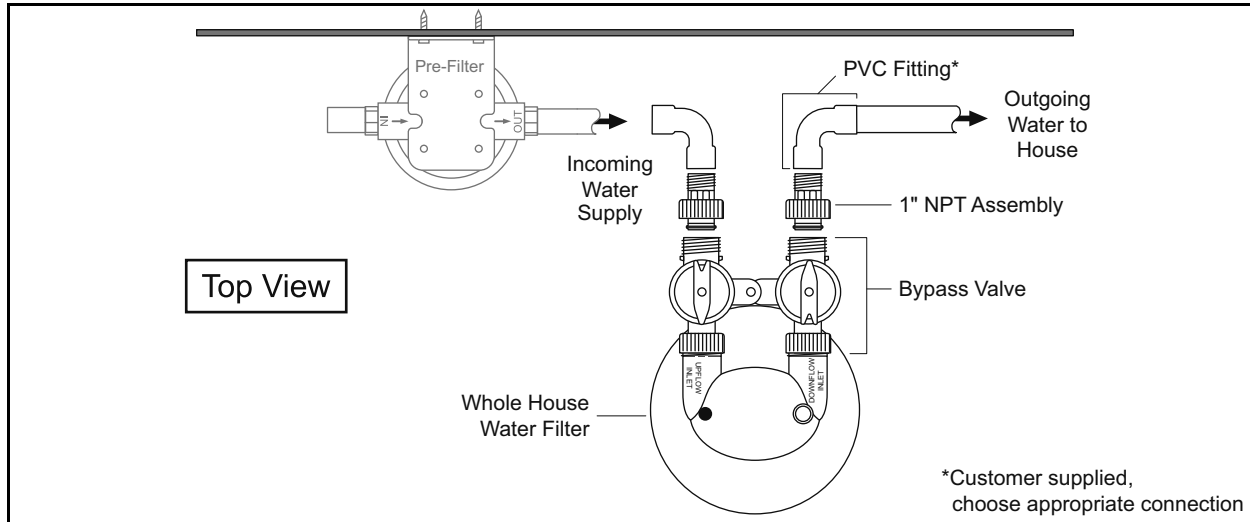

Figure 7

2. Determine the size and material of your incoming water supply line from the Pre-Filter System and choose the appropriate plumbing required to adapt to the 1" Male NPT Assembly.



CAUTION:

Do not over-tighten any of the fittings during installation.

Table 2: Bypass Valve Fittings

Note: The fitting below is designed with a 1/4" give to allow for proper pipe alignment. It will not leak and is intended to have some flexibility.

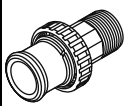
Part	Description	Qty.
	1" Plastic Male NPT Assembly: V3007-04 WS1 Fitting 1" Plastic Male NPT Assembly (2); O-Rings (2), Split Rings (2), and Connectors (2)	1 bag

3. Install the fitting onto the upflow and downflow inlet sides of the Bypass Valve. Follow the diagram supplied with the fitting.
4. Connect the incoming water supply from the to the fitting on the upflow inlet side of the Bypass Valve.
5. Connect the outgoing water supply to the downflow inlet side of the Bypass Valve.

Whole House Salt Free Water Softener/Conditioner Tank Installation

1. Level the Pelican Salt Free Water Softener/Conditioner.



Notice:

If the tank is not level, lift the tank straight up 6 inches and tap it on the ground until the tank stands vertical. The bottom of the tank is round and the boot allows the tank to stand upright.

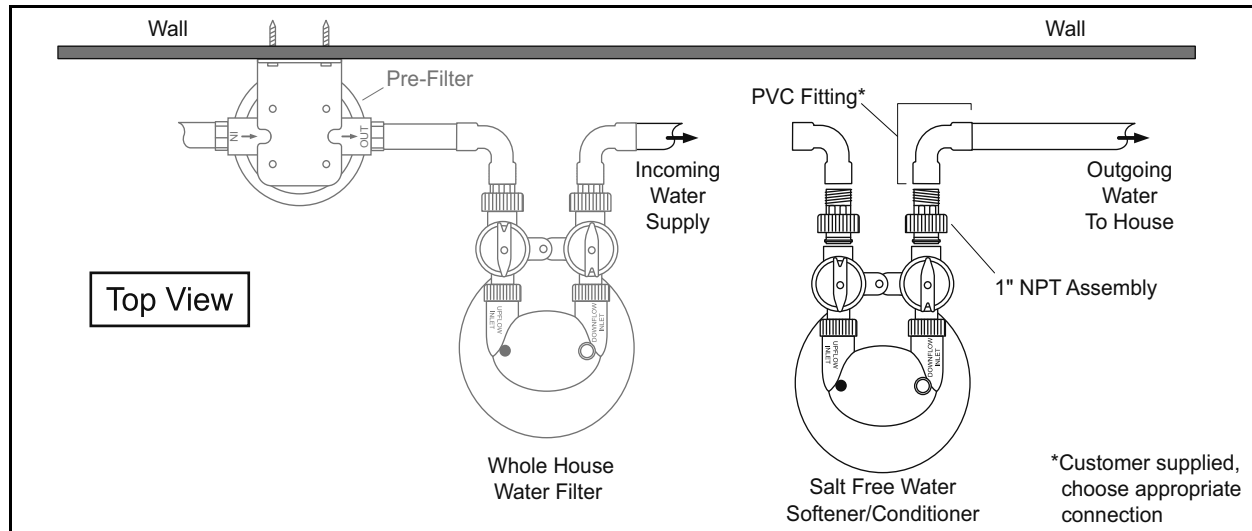

Figure 8

2. Determine the size and material of your incoming water supply line from the Whole House Water Filter and choose the appropriate fittings required to connect it to the Bypass Valve.



CAUTION:

Do not over-tighten any of the fittings during installation.

Table 3: Bypass Valve Fittings

Note: The fitting below is designed with a 1/4" give to allow for proper pipe alignment. It will not leak and is intended to have some flexibility.

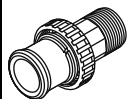
Part	Description	Qty.
	1" Plastic Male NPT Assembly: V3007-04 WS1 Fitting 1" Plastic Male NPT Assembly (2): O-Rings (2), Split Rings (2), and Connectors (2)	1 bag

3. Install the fitting onto the upflow and downflow inlet sides of the Bypass Valve. Follow the diagrams supplied with the fitting.
4. Connect the incoming water supply from the Pre-Filter System to the fitting on the upflow inlet side of the Bypass Valve.
5. Connect the outgoing water supply to the downflow inlet side of the Bypass Valve.

Media Soak

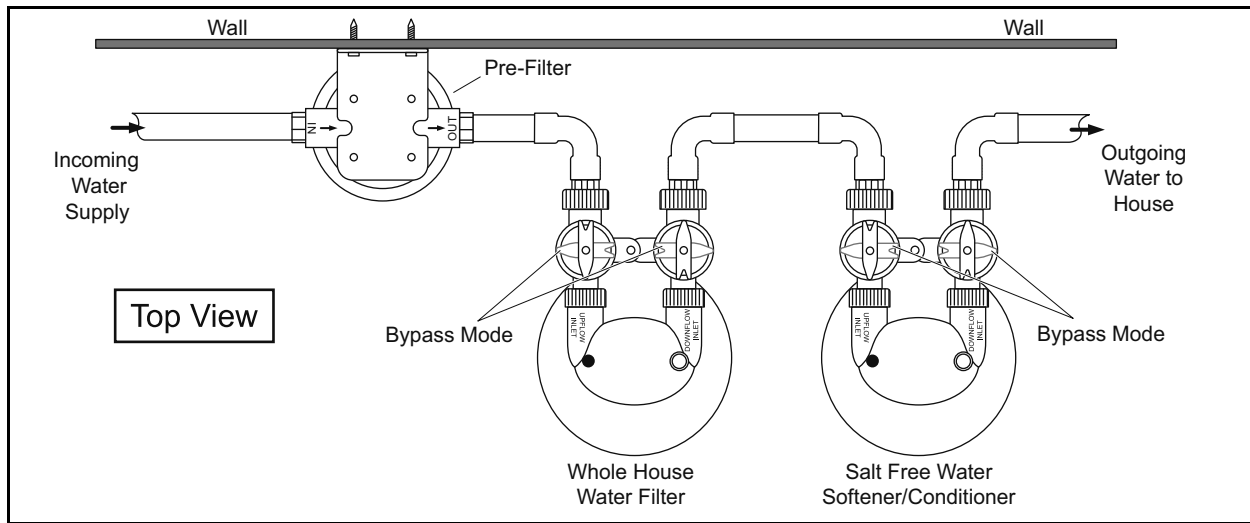

Figure 9

⚠ CAUTION:

The Pelican Whole House Water Filter must be in the bypass position during this process (see Figure above).

1. Open a cold water faucet or test spigot close to the downstream of the Water Softener.
2. Turn the water back on at the main shut-off valve allowing the system to fill with water. The air being displaced will escape through the open fixture downstream.
3. Turn the arrows on the Bypass Valve into the Bypass Mode position displayed above to bypass the tank. This will allow you to isolate the system and restore water supply to the home/building during the media soak.
4. Allow the tank to soak for at least 60 minutes.

Media Flush/Condition

⚠ CAUTION:

The Pelican Whole House Water Filter must be in the bypass position during this process (see Figure).

1. After the tank has soaked for 60 minutes, turn the main water supply back on or turn the arrows on the Bypass Valve back into their original position.
2. Flush the system by running water for 5 minutes at a high flow rate of 5 GPM (this can be achieved by using a bath tub or more than 3 faucets).

Note: The flush water may have a milky look to it. This is normal as calcium carbonate fines are flushed from the system.

3. Rinse the system by reducing the flow rate to ½ GPM and run water for 60 minutes (this can be achieved by turning one faucet ¼ of the way on).
4. Turn the Whole House Water Filter Bypass Valve to the on position (out of Bypass Mode).

Complete the Installation

1. Check for leaks.
2. Peel off the protective plastic wrap from the stainless steel tank jackets.
3. Add the Pelican logo sticker in the desired location on the tank.

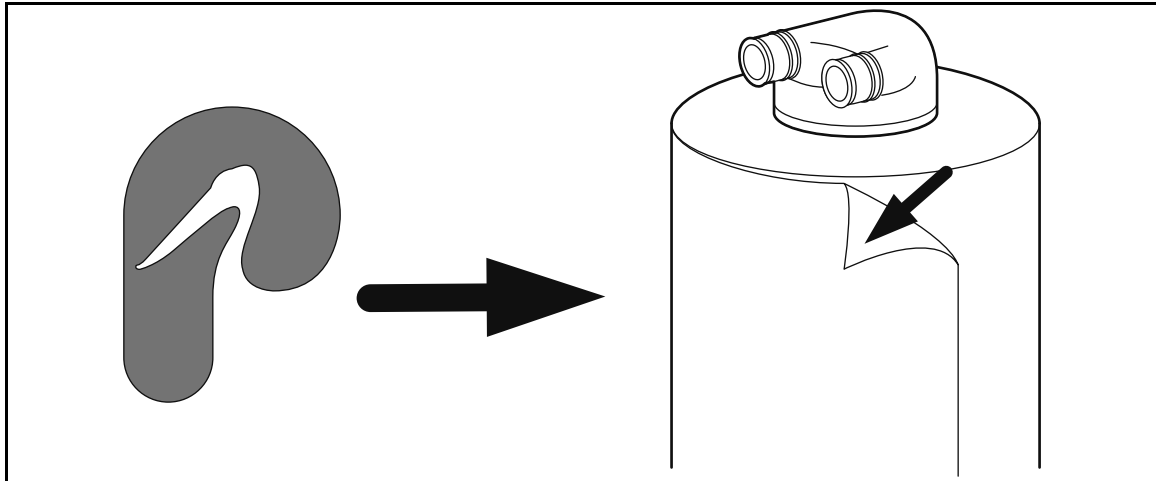

4. Wax stainless steel tank jacket(s) with wax provided or any other non-abrasive auto wax a minimum of 1-2 times per year or as needed based on the installed environment.

⚠ CAUTION:

Avoid high flow rates such as bathtub, utility sinks, hose bibs, multi-headed showers, body sprayers, or anything that is considered high flow for the first 72 hours to avoid flow restrictions caused by carbon blockage of the top basket inside the carbon tank.

Carbon dust may be released into the water lines of the house/building during the first few days of water use after carbon tank installation. The carbon dust is harmless, but may give the water a gray appearance that should diminish within a week or 10 days depending on water use.

Clean your Hot Water Heater (optional)

Cleaning and restoring the plumbing system is a major benefit of the NS3/NS6 NaturSoft system. In order to minimize the time required to complete the de-scaling process, we strongly recommend cleaning your hot water heater after a period of 3 weeks:

- Turn off the heat source, attach a hose to the drain valve at the bottom of the tank and flush the heater by opening the drain valve. After the water heater is completely filled with water, turn the heat source back on.
- Alternatively, open several fixtures in the home and let water run simultaneously for a couple of minutes. Focus on the hot water side and high flows like the bathtubs. This method is not quite as effective.

What to Expect with your New Salt Free Water Softener/Conditioner

If you have never had a water softener:

Immediately after the installation you will experience naturally soft water. All detergents will work better with treated water and you will be able to reduce the amount you use. However, there are mineral deposits and scale coating the inside of your pipes and fixtures. Over the first few weeks, this scale will dissolve, detach itself from the pipes, and come out of your faucets. This de-scaling process is temporary and will steadily diminish. During these first weeks, you will notice:

- **Reduced softness of the water.** This will be particularly evident when using hot water. The water can pick up more than ten grains of mineral content per gallon between the NS3/NS6 NaturSoft system and the faucet as it travels through the water heater and the plumbing.
- **Mineral silt in the water.** Since the existing limestone scale is softened and dissolved as part of the NS3/NS6 NaturSoft effect, it will detach in small chunks ranging in size from very fine silt to pieces larger than a grain of sand. The larger pieces may be big enough to build up in the aerator screens of your fixture. Considerable silt-like accumulations may be visible on the shower heads, so clean them weekly for the first four weeks. Higher flow rates will shear off more of the existing scale than will lower flow rates. De-scaling activity will be most obvious in bathtubs, which have high flow and hot water. You may see milky water with sand-like grit, and possible sediment or iron in the bath tub.

The water line supplying fixtures which experience the most use will be cleaned the quickest and will be the first to return to providing you the full benefits you experienced immediately following installation; rarely used fixtures will take longer.

If you had a traditional water softener:

A traditional water softener turns dissolved mineral hardness (calcium bicarbonate) into dissolved sodium bicarbonate. The NS3/NS6 NaturSoft technology maintains the healthy mineral content of the water without adding the bicarbonate. You will notice:

- **The water does not feel as soft.** The absence of the calcium and the presence of sodium bicarbonate makes the water feel slick and slimy. If you miss the slick feeling, add some baking soda (sodium bicarbonate) to your bath.
- **The water spots are more visible.** A water softener replaces calcium with sodium. The water spotting that a traditional water softener leaves behind is a salt haze that wipes off very easily and is far less noticeable than spots caused by minerals. The NS3/NS6 NaturSoft treatment results in reduced spotting compared to untreated water, but more visible spots than produced by traditional, chemically treated softened water. The NS3/NS6 NaturSoft mineral spots are much easier to clean than spots from untreated water.
- **Soap curd forms with certain products.** Oil-based soaps like Ivory will react with calcium minerals to form a sticky film. Detergent-based cleaners like shampoos, shower gels, dish soaps, and laundry detergents will react very slightly or not at all. All detergent will work better with treated water, but you will notice very little improvement when using regular bar soap or oil-based products since the minerals are largely still able to react with the fats in the soap to form the curd.
- **There is some mineral silt in the bathtub.** Depending on the water chemistry of your water supply, you may still have some scale deposits in your plumbing system.

If you have a dishwasher:

Generally, the NS3/NS6 NaturSoft system removes mineral hardness from solution and forms micro crystals; it does not physically remove the natural minerals from the water. Harsh chemicals, specifically acidic (low pH) detergents or rinse agents, can re-dissolve these crystals. This reduces the desired effect. Also, dishwashers are supplied by the hot water side of a building's plumbing system, so for the first few weeks, the water hardness inside the dishwasher will be higher than normal. For both of these reasons, you will have to adjust the combination and amounts of detergents and rinse agents. Gel packs offer a great alternative since they contain detergents and rinse agents in just the right amounts. This dishwasher detergent has received rave reviews from our customers:

■ Lemi-Shine Rinse Agent

Visit the website www.pelicanwater.com to buy the detergent online or locate a store near you to purchase.

If you have glass shower doors:

Years of untreated hardness can etch the surface of your glass allowing for soap scum and minerals to get stuck in your glass. We recommend cleaning the glass surface thoroughly with a de-scaling cleaner such as CLR then applying a few coatings of Rain-X to seal the pores on the glass surface. This process will fill the pores in the glass and allow the water to bead. (Rain-X and CLR are available at all big box stores.)

Care and Cleaning

Premium Whole House Water Filter

Your Pelican Premium Whole House Water Filter requires care and cleaning after a period of 5 years. Replacement media and instructions can be ordered on-line at www.pelicanwater.com or by calling 877-842-1635.

Sediment Filter

It is recommended that the Sediment Filter be replaced every 6-9 months depending on the amount of sediment present in the water supply. If the system has been working properly and the pressure is slowing, it may be time to change the Sediment Filter. Check the Sediment Filter and replace if necessary.

Replacing the Sediment Filter

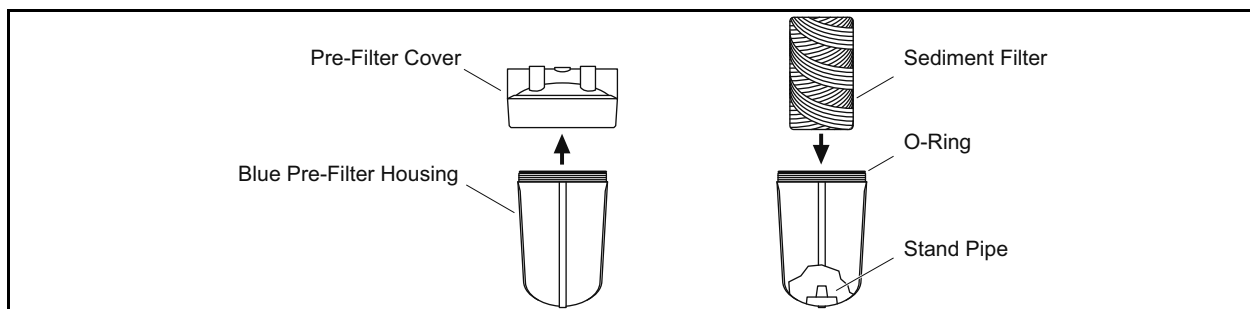

1. Turn off the main water supply to the Pre-Filter System and bypass all tanks.
2. Run a faucet (cold water) inside the house to relieve the pressure.
3. Unscrew the Blue Pre-Filter Housing clockwise using the supplied Pre-Filter Wrench.
4. Remove the existing Sediment Filter and discard.
5. Remove the O-Ring and wipe the groove and O-Ring clean. Lubricate the O-Ring with a coating of clean silicone grease. Replace O-Ring and press the O-Ring down into the groove with two fingers.
Note: This step is important to ensure the proper filter seal. Make sure the O-Ring is seated level in the groove. If the O-Ring appears damaged, stretched, or crimped it should be replaced at this time.
6. Place a new Sediment Filter onto the Stand Pipe in the Blue Pre-Filter Housing.
7. Screw the Blue Pre-Filter Housing onto the Pre-Filter Cover.
8. Turn on main water supply slowly to allow the Pre-Filter System to fill with water and put tanks back in service, out of bypass.
9. Check for leaks.

Troubleshooting

Problem	Solution
Pressure is dropping off during the carbon wash.	<p>Turn the water off and let the tank sit about 30 minutes to allow the carbon to settle down off of the basket inside the tank.</p> <p>If the pressure drops off again, let the system stand for 72 hours. There is air trapped in the carbon bed that needs to be released from the tank. After 72 hours have passed, continue the carbon wash by slowly turning the water supply back on.</p>
Water leaking at the top of the tank around the head.	<p>You may need to turn the head to tighten it. The tank head is pre-installed hand-tight, do not overtighten the head (just turn it snug).</p>
The tank leans to one side or is not level.	<p>If the tank is not level, lift the tank straight up 6 inches and tap it on the ground until the tank stands vertical. The bottom of the tank is round and the boot allows the tank to stand upright.</p>
<p>The diagrams illustrate two methods for leveling the tank. The top row shows an 'Unlevel Tank' on an 'Unlevel Boot'. The first diagram shows the tank tilted. The second diagram shows the tank being lifted upwards, indicated by an upward arrow. The third diagram shows the tank leveled, indicated by a downward arrow. The bottom row shows an 'Unlevel Tank' on a 'Level Boot'. The first diagram shows the tank tilted. The second diagram shows the tank being lifted upwards, indicated by an upward arrow. The third diagram shows the tank leveled, indicated by a downward arrow, with labels for 'Level Tank' and 'Unlevel Boot'.</p>	
Water inside the tank is gray.	<p>This is normal with all carbon filters and this will slowly fade away. The carbon inside the tank can still have air pockets inside that when released, turn the water a little gray with carbon dust. The carbon dust is harmless.</p>
Water pressure is slowing.	<p>It is recommended that the Sediment Filter be replaced every 6-9 months depending on the amount of sediment present in the water supply. If the system has been working properly and the pressure is slowing, it may be time to change the Sediment Filter. Check the Sediment Filter and replace if necessary.</p>
Water appears grey or cloudy.	<p>Water may appear grey or cloudy for the first seven to ten days after installation due to extra carbon dust.</p>

Problem	Solution
Water pressure is slowing immediately after installation.	High flow rates such as bathtubs, utility sinks, hose bibs, multi-headed showers, body sprayers, or anything that is considered high flow for the first 72 hours should be avoided. If you suspect a carbon blockage of the top basket due to a high-flow situation within the first 72 hours of installation, turn off any running water for at least 10 minutes. This will clear the blockage and you can resume using water at low or normal flow rates.

Warranty

Pelicans Limited Lifetime Warranty

Pelican Water ("Pelican") warrants to the end user ("customer") that its tanks (13" & smaller), valves, in/out heads, bypass's, fittings, Natursoft media and housings ("Covered Items") will be free from defects in material and workmanship under normal use and service for the life of the system. No warranty is made with respect to defects or damaged due to neglect, misuse, alterations, accident, misapplication, physical damage, installation on water quality outside guidelines for system or damaged caused by fire, acts of God, or freezing.**

Limitations and Responsibilities

Pelican's obligation to the customer under these warranties shall be limited, at its option, to replacement or repair of Covered Items by these warranties, labor is not covered. Prior to return or repair of Covered Items, the customer must obtain a return goods authorization number from Pelican and at Pelicans option, return the Covered Items freight prepaid. Any Covered Item repaired or replaced under these warranties will be returned prepaid standard freight to the original point of shipment. Expedited freight options are available at customer expense.

No warranty is made with respect to defects or damaged due to neglect, misuse, alterations, accident, misapplication, physical damage, or damaged caused by fire, acts of God, or freezing. These warranties apply only to the original registered owner so long as the owner owns the home in which the unit was originally installed. Customer must register their system with Pelican within 90 days of purchase* in order to obtain a warranty. Warranty will discontinue after the unit is removed from the location where it was originally installed. Warranty begins on the date of delivery of product to the customer. Improper maintenance of system (i.e. not replacing filters or media) on time will be considered "neglect". Installation of any system on water conditions outside of or beyond the recommended specs of any system voids any warranty.

Pelican gives this warranty to the customer in lieu of all other warranties, express or implied, including without limitation any implied warranties of merchantability or fitness for a particular purpose or treatment of certain water and hereby expressly disclaims all other such warranties. Pelican's liability hereunder shall not exceed the cost of the product. Under no circumstances will Pelican be liable for any incidental or consequential damages or for any other loss, damage or expense of any kind, including loss of use, arising in connection with the installation or use or inability to use the Covered Items or any water treatment system the Covered Items are incorporated into. These warranties are governed by the laws of the state of Florida and may change at any time without notice.

*Failure by California and Quebec residents to complete the product registration form does not diminish their warranty rights.

**For all orders placed on or after June 3rd, 2011.

Manufacturer's Performance Guarantee

The Pelican PC600 Premium Whole House Water Filter is guaranteed to perform for 600,000 gallons or (5) years whichever comes first. The Pelican PC1000 Premium Whole House Water Filter is guaranteed to perform for 1,000,000 gallons or (5) years whichever comes first. The authorized dealers shall be responsible for the repair or replacement of defective media only, labor to replace the media is the responsibility of the purchaser.

Warranty Registration Form

Send in this Warranty Registration Form to validate your warranty or visit www.PelicanWater.com to complete warranty registration form online.

Pelican Warranty Registration Form

Date Item(s) were Received:	Order ID#:	Model:
_____	_____	_____
Dealer Purchased From:		

Model/Serial Number:		

Name:	_____	
Address:	_____	
City:	State:	Zip:
_____	_____	_____

Send To:

Pelican Water Systems
3060 Performance Circle, Suite 2
DeLand, FL 32724
Phone: 1-(877) 842-1635

Plumber's Information (optional)

We like to recommend good plumbers throughout the USA and if you were happy with your installer please give us their information so we can pass it on as a courtesy. Thank you for your time.





Name of Plumbing Company used to install system: _____

Phone #: (_____) - _____ of the Plumbing installer

!!IMPORTANT!

Do not use where water is microbiologically unsafe or with water of unknown quality without proper disinfection before or after the filter/softener system.

Product Certifications

	<p>Pelican NaturSoft-NS3/NS6– WQA Gold Seal tested and certified under NSF/ANSI61 for material safety and tested according to NSF/ANSI 42 for structural integrity only</p>
	<p>Clack V3007-xx Bypass Fittings – WWQA Gold Seal Certified to NSF/ANSI Standard 44 for material safety and structural integrity only</p>
	<p>U.S. Green Building Council</p>
	<p>The Pelican Natursoft is DVGW DW-9191 Certified for 99.6% scale prevention.</p>

Free Manuals Download Website

<http://myh66.com>

<http://usermanuals.us>

<http://www.somanuals.com>

<http://www.4manuals.cc>

<http://www.manual-lib.com>

<http://www.404manual.com>

<http://www.luxmanual.com>

<http://aubethermostatmanual.com>

Golf course search by state

<http://golfingnear.com>

Email search by domain

<http://emailbydomain.com>

Auto manuals search

<http://auto.somanuals.com>

TV manuals search

<http://tv.somanuals.com>