



Owner's Guide and Installation Manual

PELLA® EXPRESS INSTALL® STORM DOOR MODELS

NOTE TO THE INSTALLER: This Owner's Guide and Installation Manual is the property of the homeowner. Please leave it with the homeowner upon completion of the installation.



Recommended Tools

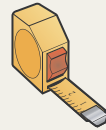

Tape Measure



Power Drill with
3/32" drill bit

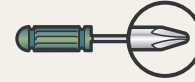

Phillips
Screwdriver #2

For safety reasons, the assistance of a second person is recommended when handling the door.

Read the legend below in order to easily follow along and install your storm door. For reference, the storm door assembly is illustrated on page 2.

Legend



Follow the steps in order, from 1 to 35.

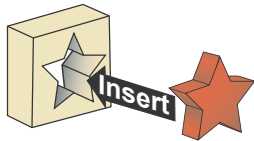

RED objects are the action items for that step.



Steps in **BLUE** apply to **LEFT HINGE** configurations **ONLY**.
(Hinge side will be determined in a later step.)



Steps in **GREEN** apply to **RIGHT HINGE** configurations **ONLY**.
(Hinge side will be determined in a later step.)

MUST READ!

Instructions in this box style are IMPORTANT!

To order replacement parts, call
1-800-374-4758

or visit us at

www.pella.com

Please have your registration number ready when you contact us either by telephone or on the internet.

TROUBLE SHOOTING GUIDE
is located on page 12 of this manual.

Lay door flat.

Before discarding the carton, make sure **ALL** parts are accounted for -- check in carton roll-ups.

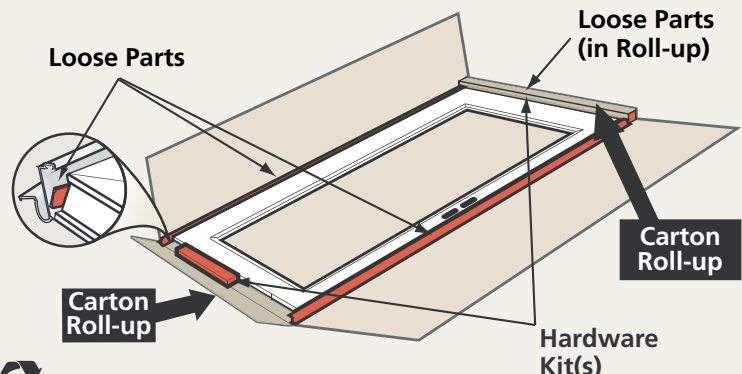

The carton material is recyclable

Storm Door Components

NOTE: Actual door styles may vary from illustrations, however, the installation steps will be the same.

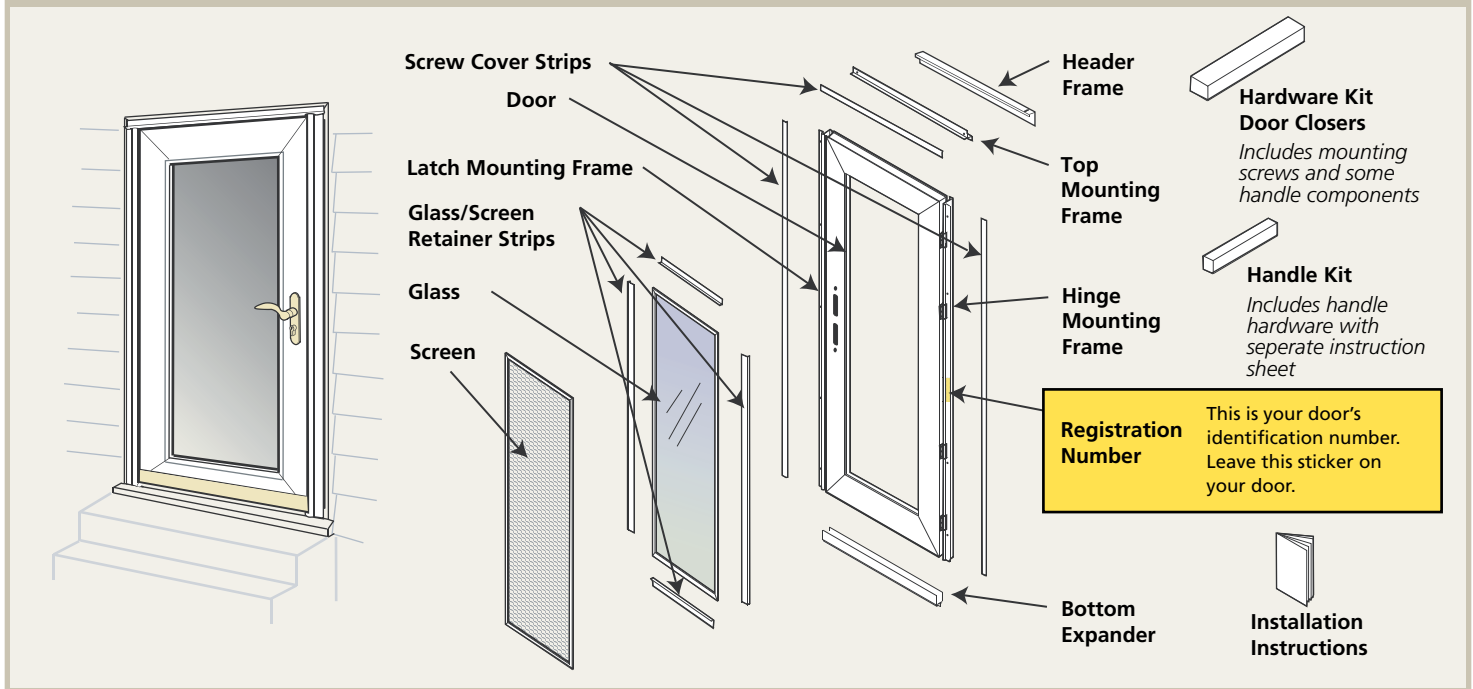

Before you begin Follow steps a, b and c to verify your entryway opening requirements.

a Locate header frame.

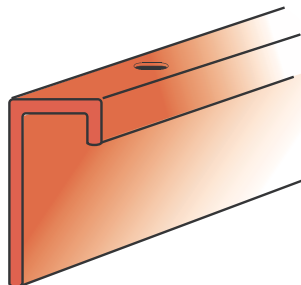

b Slide to one side of the entryway.

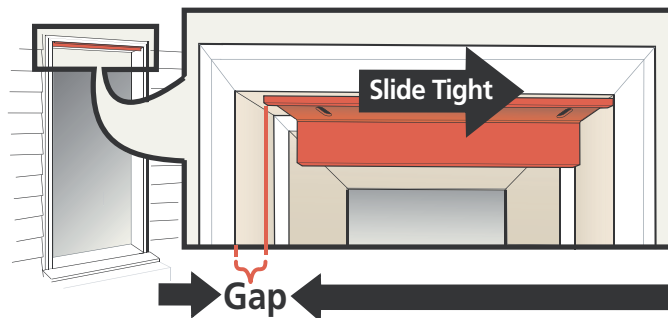

c Measure gap.

If this gap is ...

- LESS than 1/4", Go to **START** on page 3
- 1/4" or GREATER, Go to Step d, to shim

Note: if this gap is over 9/16", a custom storm door is required.

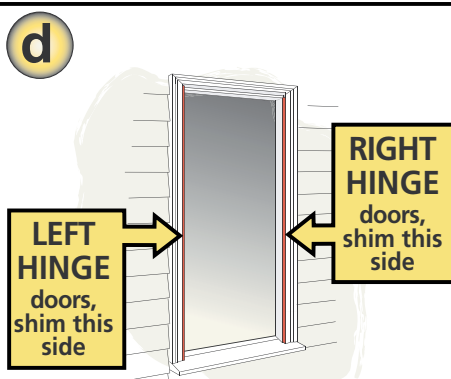

Shim on **YOUR** hinge side - see Step 6 on Page 3, to determine your hinge side.

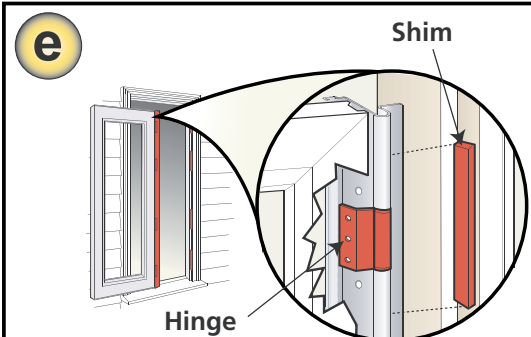

Shim may be one long piece or small 8" to 12" sections.
NOTE: small sections must fully support the hinges on the mounting frame.
 Use an appropriate shim thickness to reduce the gap in step C, to 1/4" or less.
 Household shim materials may include paint stir sticks or wooden yardsticks.

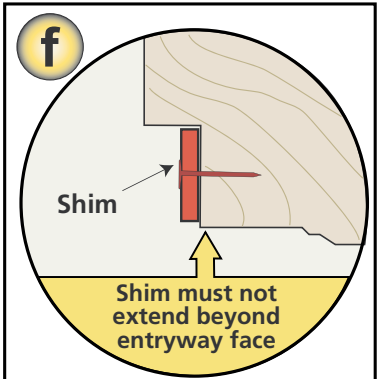

Nail shims in place.
Note: If you removed an old storm door, you may wish to paint and cover any existing holes before proceeding.
 Go to **START** on page 3.

START
Your Installation

1

Turn door over.
Remove shipping clips.

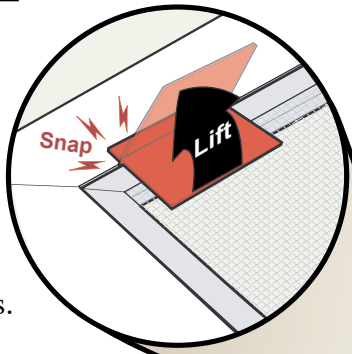

Remember this is the **INTERIOR SIDE** of the door

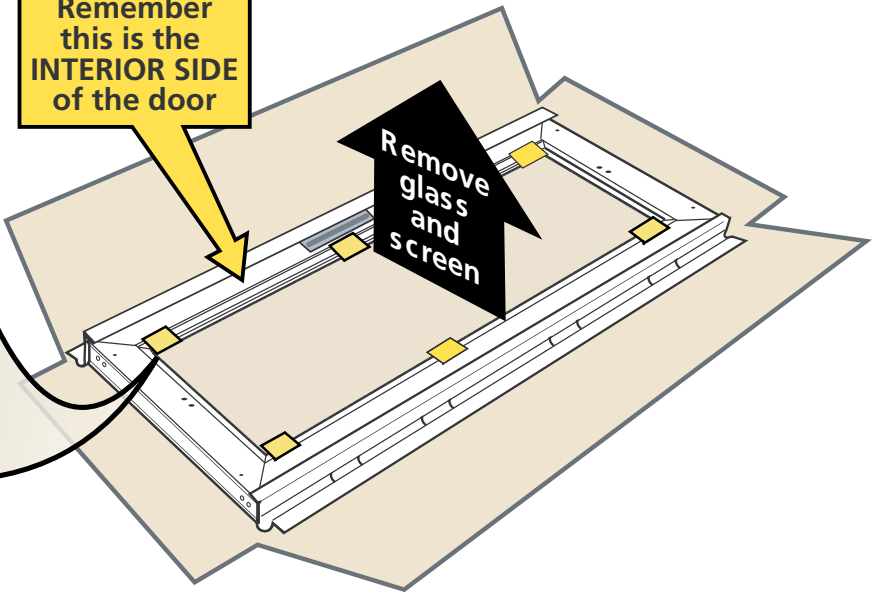

2

Remove glass and screen.

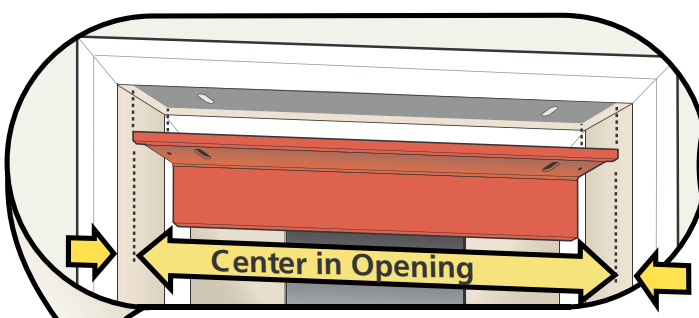

3

FIRST, center header frame in entryway opening ...

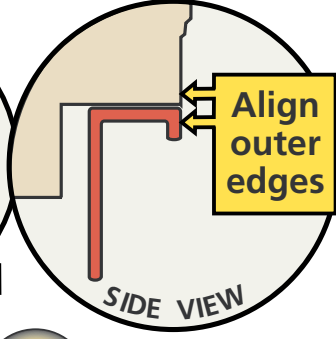

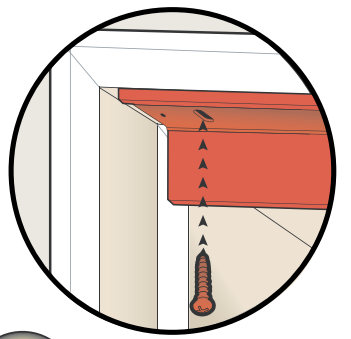

4

... THEN, align with face of brickmold.



5

Predrill the two holes.
Secure with jamb screws.

| | |
|--|---|
| <p>Drill 3/32" Pilot Holes</p>  | <p>Qty. 2 "Jamb Screw Bag" unpainted #8 x 3/4" Pan Head</p>  |
|--|---|

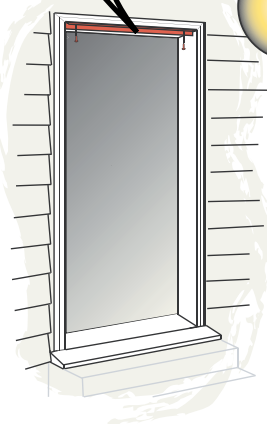

6

Determine the side you want your door to hinge.



Left Hinge Orientation
viewed from outside

LEFT HINGE
Watch for this color throughout the manual



Right Hinge Orientation
viewed from outside

RIGHT HINGE
Watch for this color throughout the manual

Continued on page 4

Continued from page 3

7

Position door for LEFT hinge or RIGHT hinge.

RIGHT HINGE DOORS position metal plate on this side

LEFT HINGE DOORS position metal plate on this side

This is the TOP of Your Door

Inside Facing UP

Right Hinge Illustration

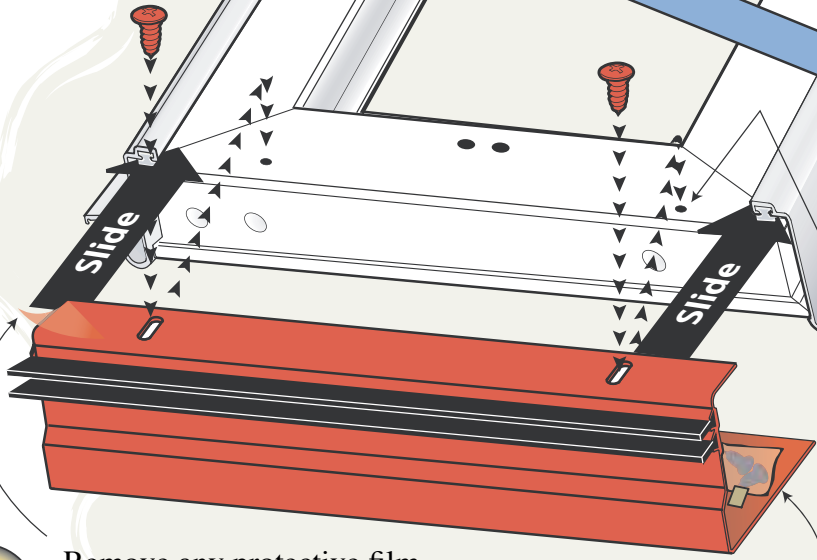
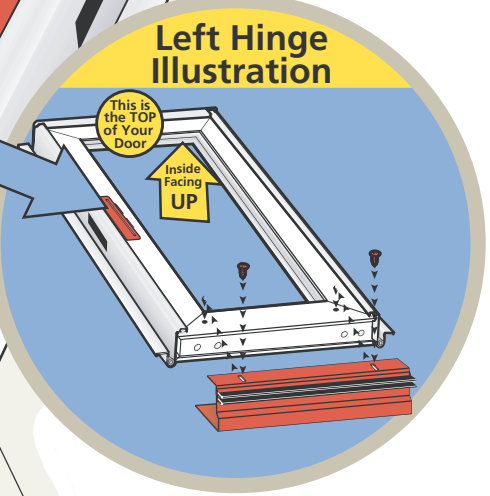

Factory Drilled Holes

8

Remove any protective film. Slide bottom expander tight onto bottom of door.

NOTE: Bottom expander is packaged with the handle for Select® 6000 models.

9

Secure with screws (Bag taped inside expander).

| | |
|-------------------------------|---|
| Use a HAND screwdriver | Qty. 2 #6 x 1/2" Pan Head (Extra screw provided) |
| | |

10

Place installation support block on door's HINGE side.

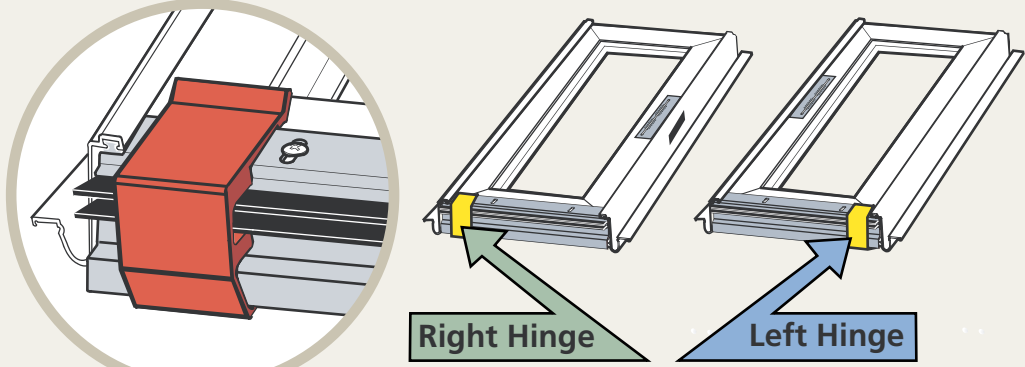

Continued on page 5

Continued from page 4

11 Set door in opening (resting on bottom spacer from step 10). Hold tight to hinge side.

12 Predrill the five hinge side hole locations. Secure with screws.

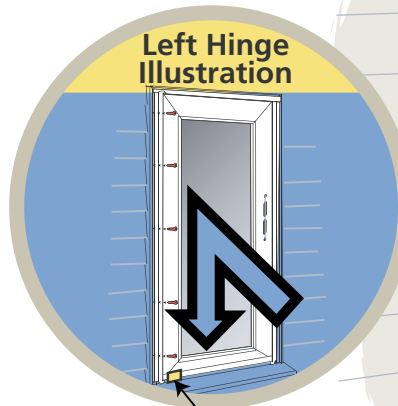
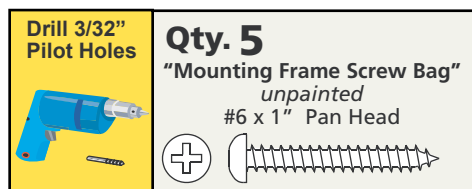

Installation Support Block

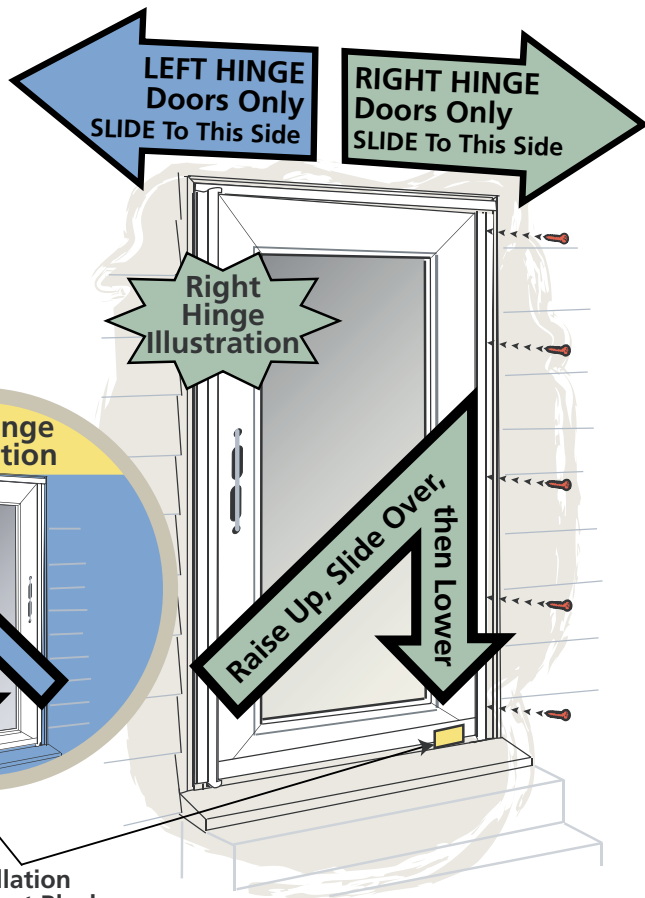

13 Open the door. Predrill the eight holes. Secure with screws.

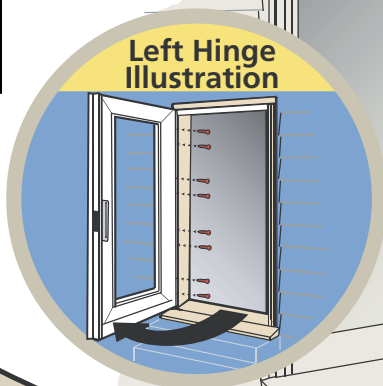
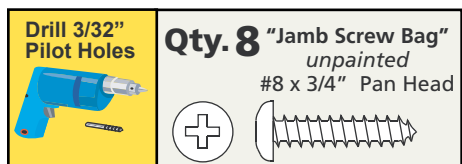

Right Hinge Illustration

Left Hinge Illustration

14 Remove and discard installation support block.

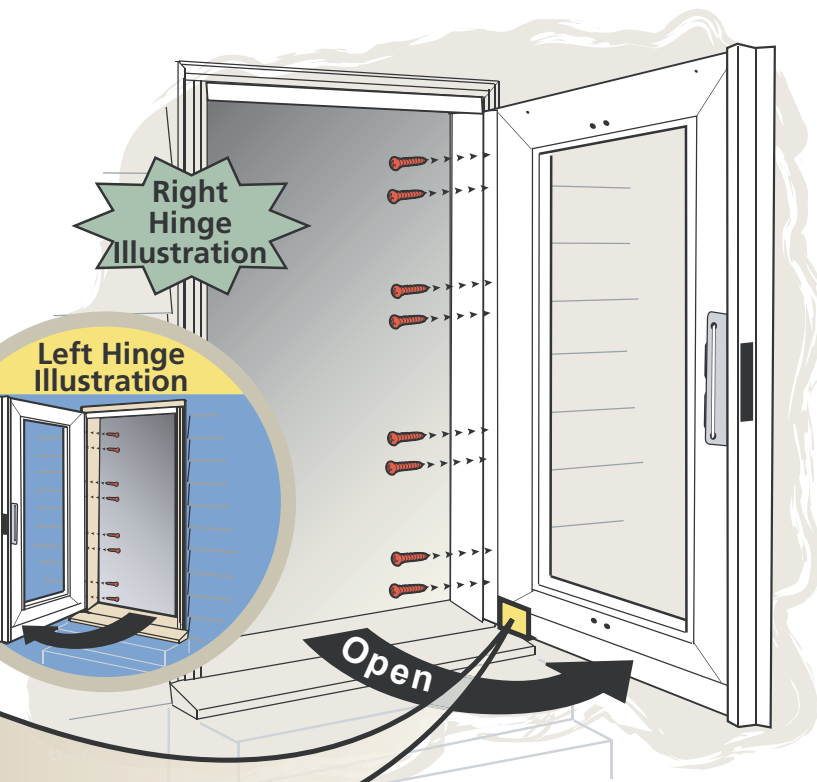
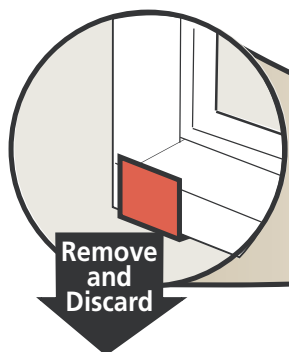

Continued on page 6

Continued from page 5

15

Install glass panel.

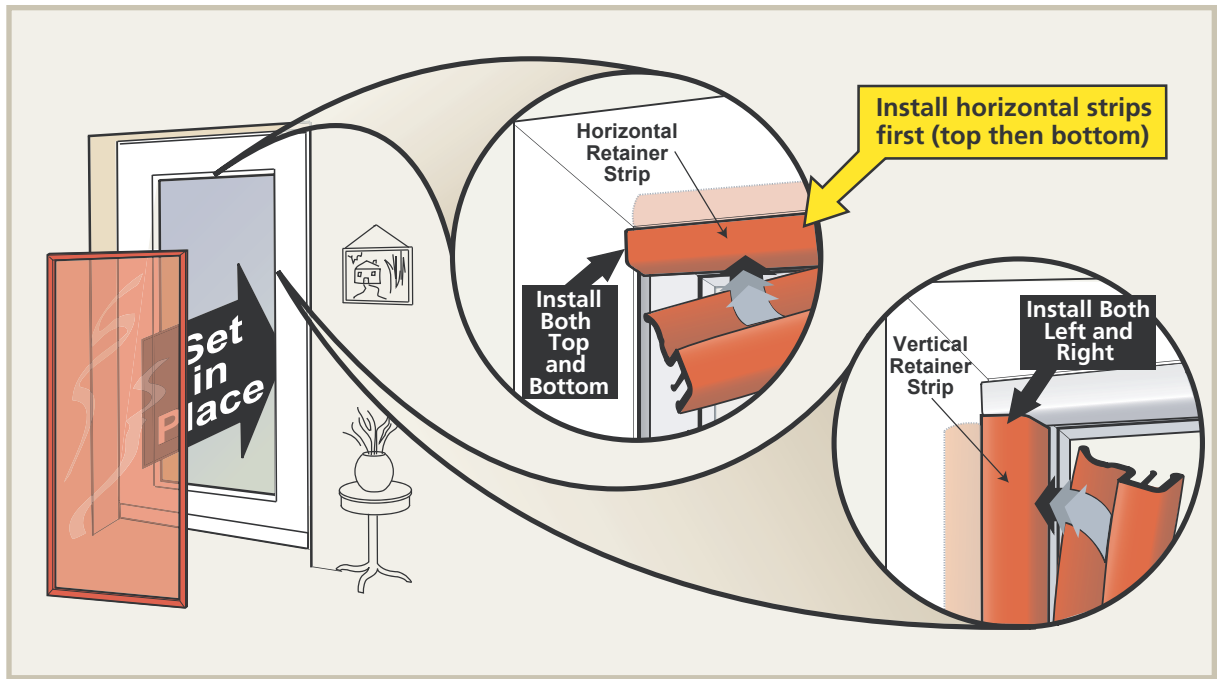

IMPORTANT:
Hold glass in place while installing retainer strips.

Secure with retaining strips.



16

Predrill the five hole locations.
Secure with screws.

| | |
|---|---|
| Drill 3/32" Pilot Holes | Qty. 5 "Mounting Frame Screw Bag" unpainted #6 x 1" Pan Head |
|  |  |

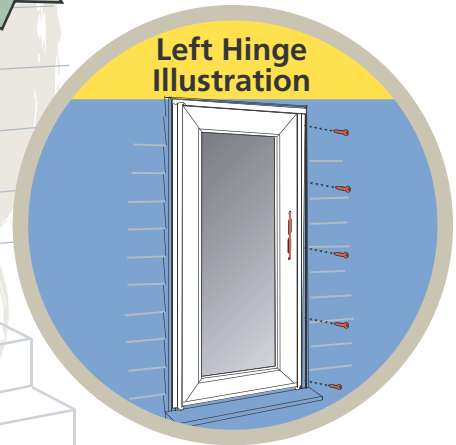

17

Remove shipping strap and
"Do not cut" label.

Continued on page 7

18

Position top mounting frame.

Note: if you have interference with siding, remove the break-off tab with a pliers, then caulk along the back surface, for protection from rain.

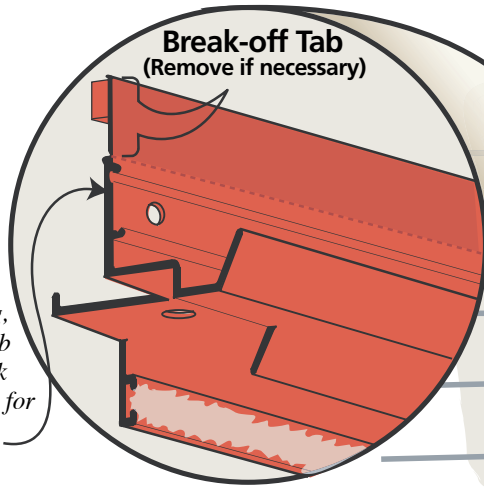

19



Close door.

Rest mounting frame on door.

Pre-drill the two hole locations.

Secure with screws.

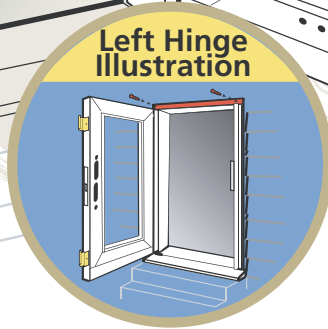
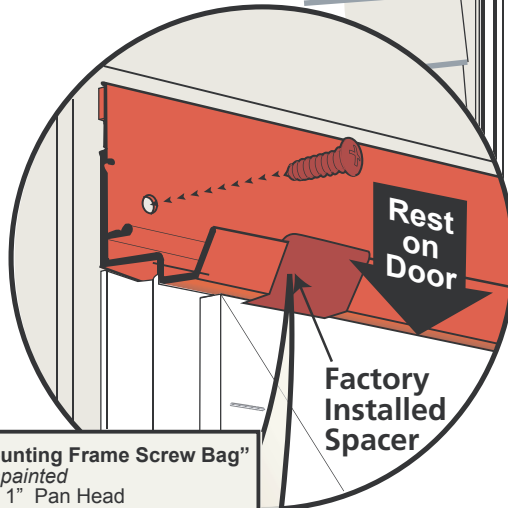
Drill 3/32" Pilot Holes Qty. 2 "Mounting Frame Screw Bag" unpainted #6 x 1" Pan Head



20

Remove the two spacers.

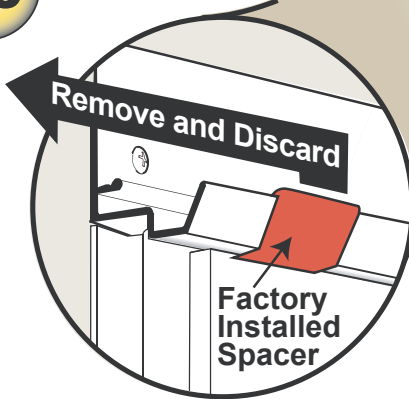

21

Remove the two yellow clips.

Re-install the screws.

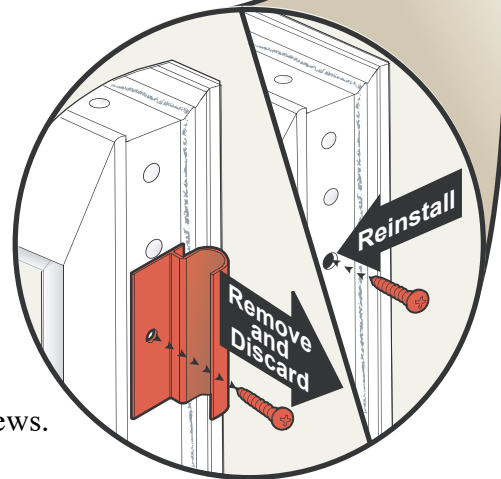

22

Install your handle set.

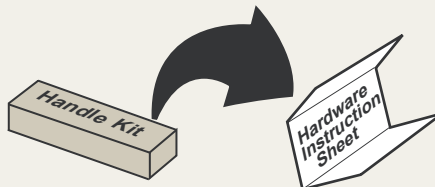
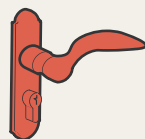

Go to the separate hardware instruction sheet in the handle kit

Continued from Hardware Instruction

23

Remove the two hole plugs from the closer bases.

Insert into the factory drilled holes near the top corners of the door.

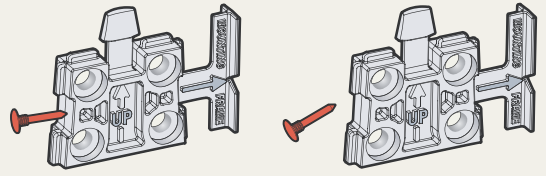

Qty. 2 Hole Plugs
Break off of closer base

24

Determine which side to install the closers.
[Right versus Left].

LEFT HINGE Install Closers on This Side.

RIGHT HINGE Install Closers on This Side.

25

Align closer base arrow with small notch on mounting frame (install both top and bottom).

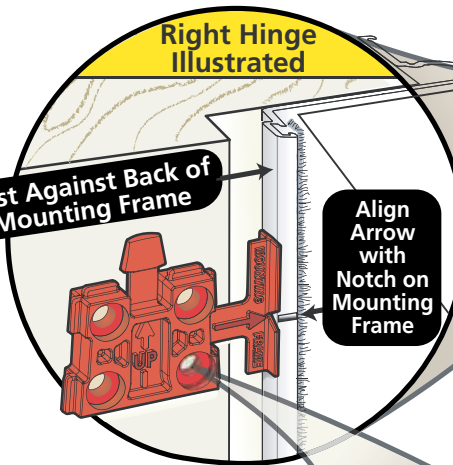

26

Predrill holes (3/32" bit). Secure with screws.

Drill 3/32" Pilot Holes

Qty. 4 each
"Closer Screw Bag"
Unpainted
#10 x 1 1/2" Pan Head

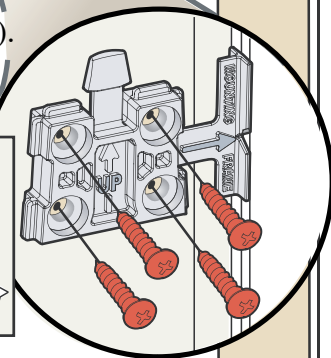

27

Break off alignment tabs.

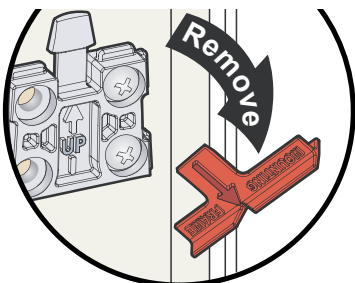

Approx 1-1/2"

Interior Side of the Door

Top Closer Location (Right Hinge)

Bottom Closer Location (Right Hinge)

Right Hinge Illustration

Rest Against Back of Mounting Frame

Align Arrow with Notch on Mounting Frame

Left Hinge Illustration

Top Closer Location
Bottom Closer Location

Continued on page 9

Continued from page 8

28 Locate the top and bottom closers.

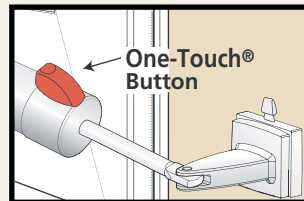
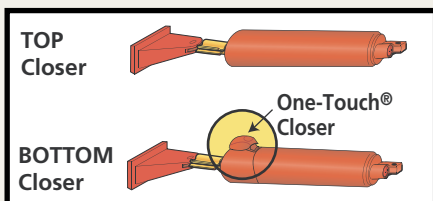

To Use:
Open the door, then tap the button.

To Close:
Nudge the door open slightly.

29 Slide top and bottom closers onto their bases.
Rotate bottom closer as shown.

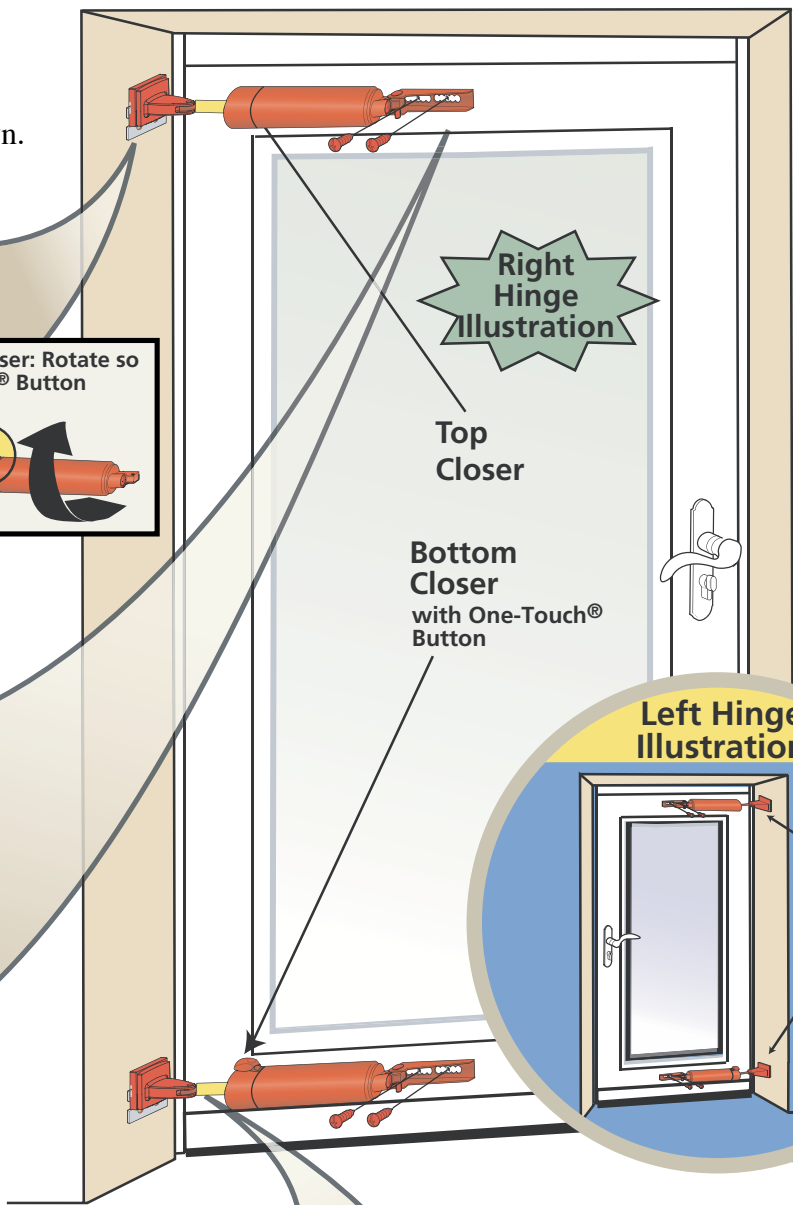
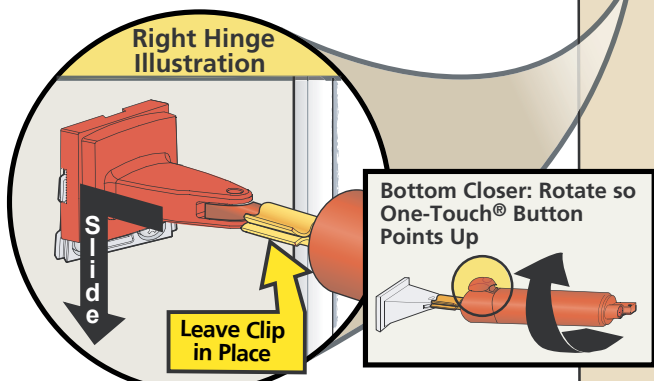

30 Pin door bracket onto closer assembly.

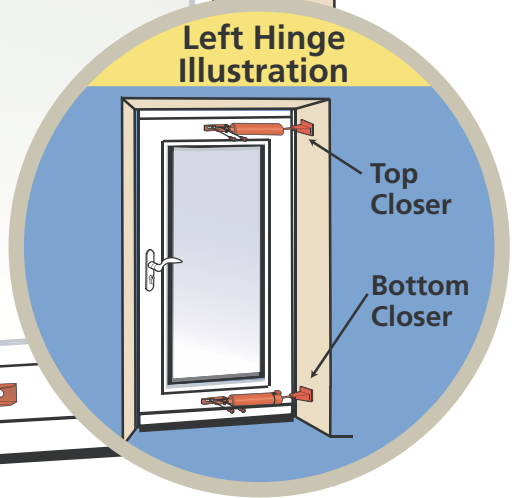
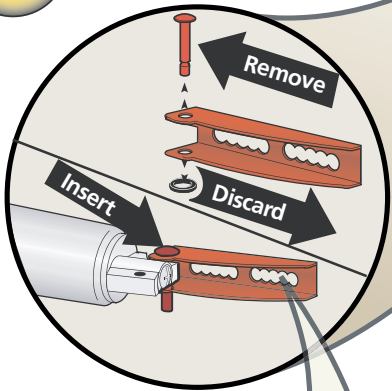

31 Close door. Secure door bracket with screws.

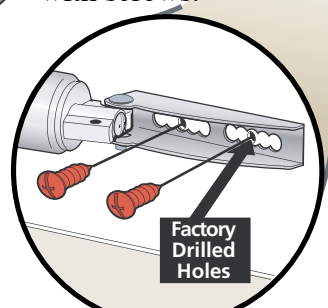

32 Discard clips (top and bottom).

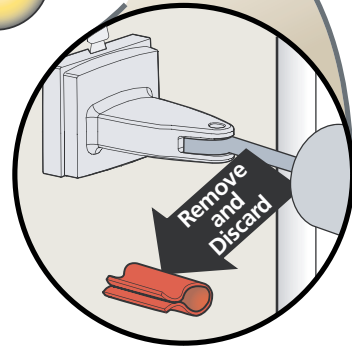

33 Adjust closer speed with adjustment screw.

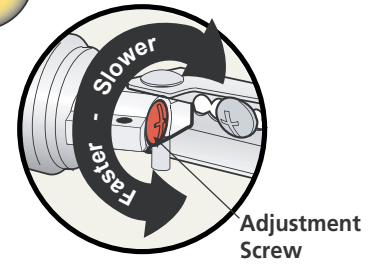

Qty. 2 each
"Closer Screw Bag"
color matched to door
#10 x 5/8" Pan Head

Continued on page 10

Continued from page 9

34

Close door.
Adjust bottom expander to lightly contact the sill.

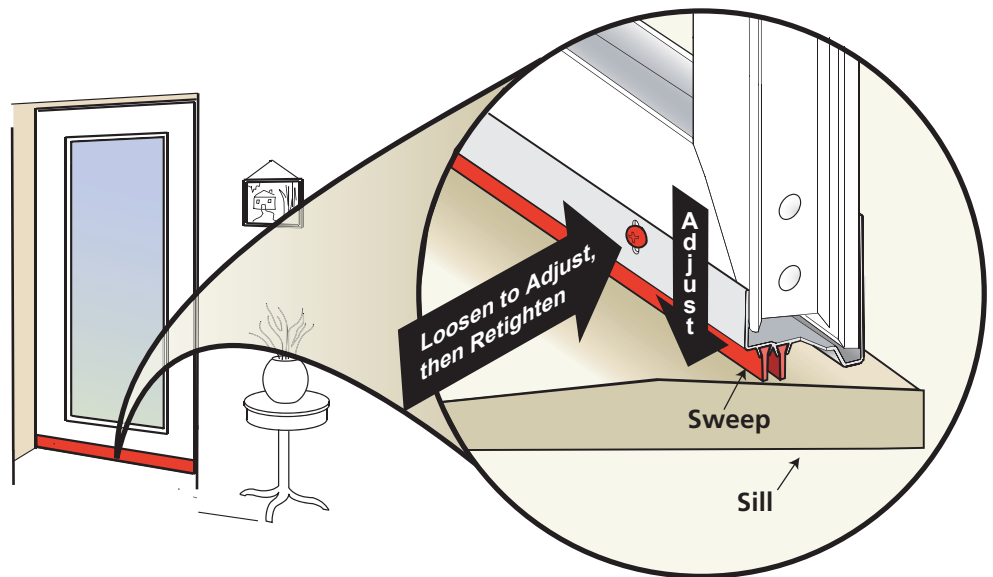

35

Install screw cover strips (1 Horizontal, 2 Vertical).

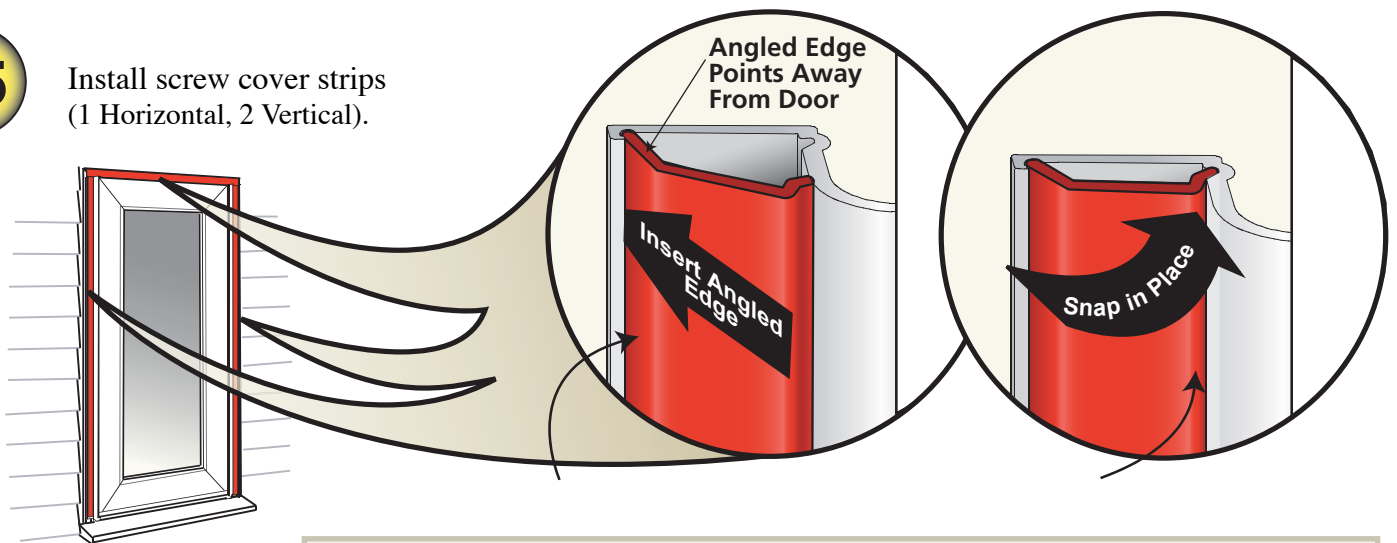

Hint: With the angled edge in place, run your finger down the length of the inner edge to snap in place.

Finished with the installation. See page 11 for care and maintenance.

Glass or Screen Operation

To Remove:

Remove the vertical strips first, then the horizontals, by pulling the corners away from the door frame.

IMPORTANT:

Hold the glass in place before removing the top retaining strip.

To Install:

Hold the glass or screen in place and insert the top then bottom horizontal strips first, then the verticals.

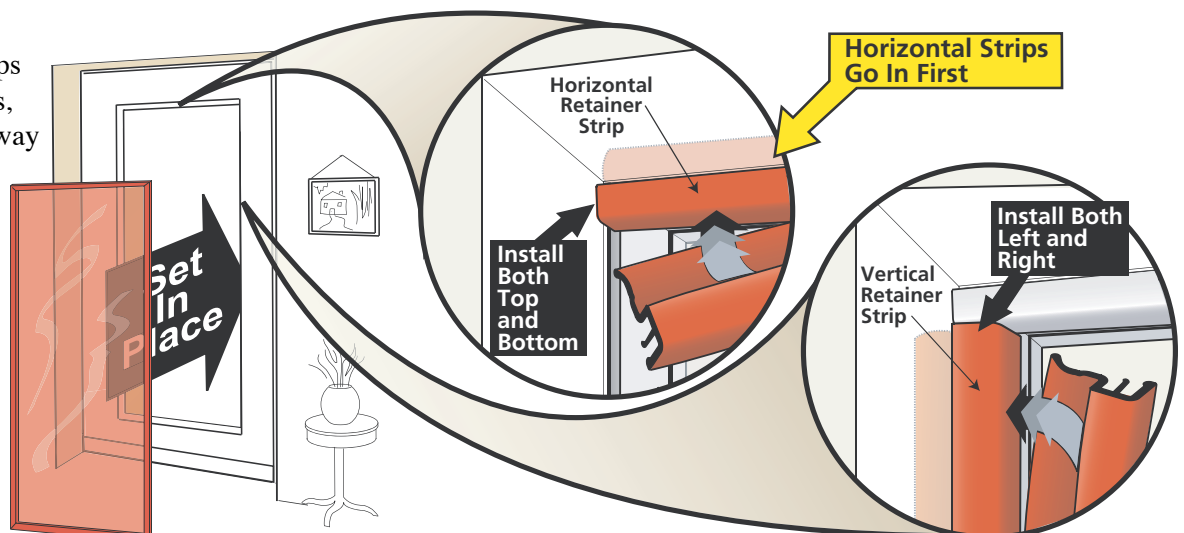

Care and Maintenance

Door Cleaning

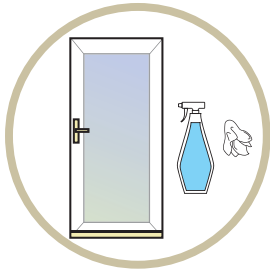

Use a soft cloth with any household grease-cutting cleaner to clean the door.

PLEASE NOTE: Thin marks on the painted surfaces of the door can be removed using turpentine and light rubbing with a clean cloth.

IMPORTANT: DO NOT use brass polish or steel wool on the bottom expander - - Use a household grease-cutting cleaner or a mild soap and water solution.

Glass Cleaning

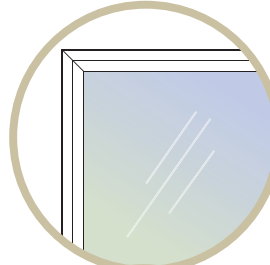

PLAIN GLASS

Models with decorative glass - follow instructions below.

PLEASE NOTE: DO NOT use an ammonia-based cleaner for the first cleaning of the glass.

FIRST CLEANING: Use a mixture of one part vinegar with four parts water to remove the protective coating (for shipping purposes) from the glass.

ROUTINE CLEANING: Use any household glass cleaner.

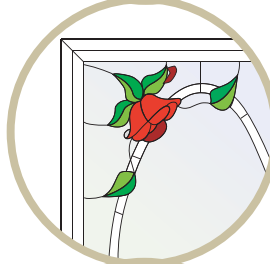

DECORATIVE STAINED GLASS (If included with your model)

ONE-OF-A-KIND ORIGINALS

The stained glass on your Pella® panel is hand crafted. Slight imperfections or variation of color are normal. No two glass panels are exactly alike.

CLEANING THE STAINED GLASS

Use a household glass cleaner or mild soap and water to clean the stained glass.

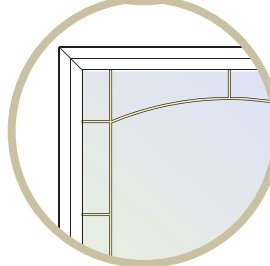

DECORATIVE CAMING (If included with your model)

The glass is hand crafted with decorative caming.

Use a household glass cleaner or mild soap and water to clean the caming.

For Bright Brass and Satin Nickel caming ONLY:

You may use a quality brass polish or brass cleaner. Follow the product's directions and carefully wipe down the caming. Be sure to wipe all of the cleaner from the glass. Use a toothbrush to carefully remove any cleaner from between the caming edges and the glass.

Cleaning may also be done by using #0000 steel wool. Carefully rub down the caming with light even strokes - avoid touching the glass with the steel wool.

PLEASE NOTE: For brass handle cleaning, see "Cleaning & Refinishing" below.

Handle Cleaning

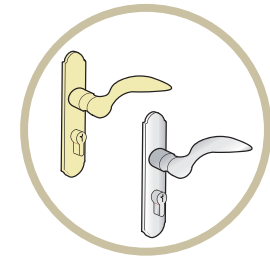

BRASS & OTHER METALLIC HANDLES

Routine Cleaning: Use a soft cloth with a mild soap and water solution to clean the surfaces. Apply a high quality, non-abrasive automobile wax to polish.

Note: DO NOT use ammonia-based cleaners on brass or other metallic finish handles.

Cleaning & Refinishing Damaged Brass

If your Pella® door includes a solid brass handle, the brass is polished and sealed with a clear coating by the manufacturer. Should the finish be accidentally damaged by an abrasive or sharp object, it will succumb to a natural oxidation process that occurs when the elements contact unprotected brass. Brass has an enduring quality, in that it can be refurbished to its original polished finish again and again by using a quality brass polish and a soft cloth. Do not clean the bottom expander in this manner - see door cleaning above.

1. Remove the hardware from the door so the finish of the door will not be affected. See the hardware instructions for removal.
NOTE: you may be able to leave the hardware in place on the door when polishing the handle only - make certain to completely mask off all areas around the handle before starting. If polishing the key cylinder, protect the internal mechanism by covering the opening with tape.
2. Use a quality brass polish or cleaner to clean the brass - follow the product's directions and cautions. Note: Firm rubbing may be necessary to loosen the coating on the brass.
3. Reseal the brass per instructions below.
 - a. Use the properties from the brass polish you used to clean the brass. (Easiest method, but requires more frequent polishing.)
 - b. Apply a high quality, non-abrasive, polymer-based automobile wax to seal the surface.
 - c. Apply a new clear coat with a clear lacquer spray - follow the product's directions. (Most difficult, but lasts the longest.)

PLEASE NOTE: If you removed the hardware from the door, lubricate any internal workings with a spray lubricant. Re-install the hardware on the door. See the hardware instructions for installation.

Trouble Shooting Guide

If you have a question that you do not see listed here, or have not been able to resolve through your Pella® Owner's Manual and Installation Guide, call one of our customer service representatives toll-free at 1-800-374-4758.

| Common Questions | Probable Causes | Suggested Solutions |
|--|--|--|
| Door does not open or close properly. | Entryway framing is out or square/plumb or frame is warped | 1. Verify the entryway framing and shim as necessary. [See Page 2] |
| | Closer(s) out of position or adjustment. | 1. Remove the adjustment screw from the closer(s), cycle the door a few times, then replace the screw. [See Page 9, Step 33] 2. Adjust the position of the closer door bracket until the door operates properly. [see Page 9, Step 31] 3. If switching from glass to screen, vary the closer speed for proper operation. [see page 9, step 33] |
| | Bottom Expander is out of position. | 1. Verify the expander is centered on the door – adjust if necessary. [See Page 4] 2. Verify the expander is not too low - adjust as necessary. [See Page 10, Step 34] |
| | Header Frame is out of position. | 1. Verify header frame is centered and aligned in the opening - adjust as necessary. [See Page 3, Steps 3 & 4] |
| | Hinges are binding | 1. Verify mounting frame screws are not over tightened - back off screws slightly. [See Page 5, Steps 12 and 13] 2. Verify entryway framing is not twisted or warped - shim or modify as necessary. 3. Verify hinge mounting frame is not twisted or bent - replace if necessary. |
| Handle does not latch properly. | Latch not hitting trim plate | 1. Adjust the trim plate until the latch catches. [See separate hardware instruction] |
| | Closer is out of position | 1. See "Closer(s) out of position" in the "Door does not open or close properly" question above. |
| Water between the storm door and entry door. | Bottom Sweep is making a tight seal against the door sill | 1. Open the storm door and notch up to 1/2" off the ends of the black vinyl sweep. |

Pella® Storm Doors Limited Warranty

Congratulations on choosing a Pella storm door to protect and beautify your home. This superior quality door has been designed to give you years of trouble-free service, and you are protected by this limited warranty:

Pella warrants to the ORIGINAL HOMEOWNER PURCHASER of this storm door that it will, without charge to the purchaser, provide parts or exchange, at its option, any door determined to be defective in material or workmanship for 20 years after the purchase date. The purchaser will be responsible for transportation charges. Should the door be determined to be defective in material or workmanship AFTER 20 years from the purchase date, the original purchaser may buy one new Pella storm door at 50% of the then-current manufacturer's suggested list price for as long as the original purchaser owns the home on which the door was installed. The purchase must be made directly from the factory, and all transportation charges are the responsibility of the purchaser.

Should the door be determined to be defective and the purchaser incurs a reinstallation cost within three years of the purchase date, he or she may be reimbursed for these costs up to a maximum of \$25.00, upon furnishing a copy of the invoice for the reinstallation costs.

As a condition of this warranty, it is required that the door be used for residential use only in an owner-occupied home, that it be installed properly as an operating door according to manufacturer's instructions, and that it not be altered in any way. For multi-unit housing applications, ask your dealer for a copy of the appropriate warranty or phone Pella's Customer Service Department at the phone number listed below. This warranty is not transferable.

To make a claim under this warranty, you should:

- Call our Customer Service Department at 1-888-646-5354 or write to Pella Warranty Service; 2333 Eastbrook Drive; Brookings, SD 57006 USA.
- Furnish the original or a copy of the sales receipt or other documents showing the original purchase date and that you are the original purchaser of this door. Exchange is limited to supplying a replacement door of comparable size, style, and color and does not include any cost of removal or installation except as noted above.

The warranty on the latch set and air closer is one year, and any labor charges are not covered. This warranty excludes all damage to glass and screen. This warranty does not cover problems caused by improper storage, handling, installation, use, modification, or maintenance, by Acts of God or by accidents, including accidental glass breakage. It does not apply to normal wear or discoloration of finish; finish problems caused by mechanical damage or abrasion; normal effects of sun and weather, including acid rain, salt spray, or other corrosive elements; damage caused by severe wind; or damage caused by customer abuse or neglect. Oil-Rubbed Bronze is a living finish that will develop its own unique patina with use and is not covered under the Lifetime Finish Guarantee. Bright Brass, Antique Brass, Brushed Brass and Satin Nickel hardware is guaranteed not to tarnish and carries a lifetime finish warranty for as long as the purchaser owns their home.

THIS WARRANTY EXCLUDES ALL INCIDENTAL AND CONSEQUENTIAL DAMAGES. Nothing in this document shall give rise to or extend the period of any warranties implied under state or provincial law, and no implied warranty shall extend beyond the periods covered by this written warranty. Neither Pella Corporation nor any seller of Pella products will be responsible for incidental or consequential damages which may result from a product defect or malfunction. Some states do not allow the exclusion or limitation of incidental or consequential damages, so the above limitation or exclusion may not apply to you. This warranty gives you specific legal rights, and you may have additional rights which vary from state to state. Effective 7/2006.

Free Manuals Download Website

<http://myh66.com>

<http://usermanuals.us>

<http://www.somanuals.com>

<http://www.4manuals.cc>

<http://www.manual-lib.com>

<http://www.404manual.com>

<http://www.luxmanual.com>

<http://aubethermostatmanual.com>

Golf course search by state

<http://golfingnear.com>

Email search by domain

<http://emailbydomain.com>

Auto manuals search

<http://auto.somanuals.com>

TV manuals search

<http://tv.somanuals.com>