

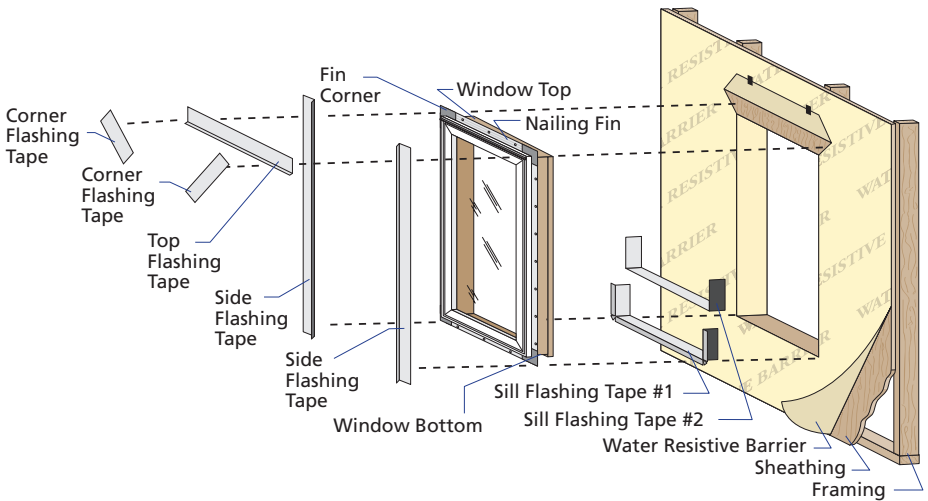

**INSTALLATION INSTRUCTION - INSTRUCCIONES DE INSTALACIÓN
FOR CLAD AWNING, CASEMENT &
NON-RECTANGULAR CASEMENT WINDOW
PARA LAS VENTANAS DE MADERA RECUBIERTAS DE ALUMINIO
TIPO BISAGRAS, BATIENTE Y BATIENTE NO-RECTANGULAR**



Always read the Pella[®] Limited Warranty before purchasing or installing Pella products. By installing this product, you are acknowledging that this Limited Warranty is part of the terms of the sale. Failure to comply with all Pella installation and maintenance instructions may void your Pella product warranty. See Limited Warranty for complete details at <http://warranty.pella.com>.

Installation Instructions for Typical Wood Frame Construction.

These instructions were developed and tested for use with typical wood frame wall construction in a wall system designed to manage water. These instructions are not to be used with any other construction method. Installation instructions for use with other construction methods, multiple units or bow and bay windows, may be obtained from Pella Corporation, a local Pella retailer, or by visiting <http://www.pella.com>. Building designs, construction methods, building materials, and site conditions unique to your project may require an installation method different from these instructions and additional care. Determining the appropriate installation method is the responsibility of you, your architect, or construction professional.

YOU WILL NEED TO SUPPLY:

- Cedar or Impervious shims/spacers (12 to 20)
- 2" galvanized roofing nails (1/4 lb.)
- Closed cell foam backer rod/sealant backer (12 to 30 ft.)
- Pella® SmartFlash™ foil backed butyl window and door flashing tape or equivalent
- High quality exterior grade polyurethane or silicone sealant (1 tube per window)
- Great Stuff™ Window and Door Insulating Foam Sealant by the Dow Chemical Company or equivalent low pressure polyurethane window and door foam - DO NOT use high pressure or latex foams
- Interior trim and/or jamb extensions (15 to 40 ft.)

TOOLS REQUIRED:

- Tape measure
- Level
- Square
- Hammer
- Stapler
- Scissors or utility knife
- Small flat-blade screwdriver
- Sealant gun

REMEMBER TO USE APPROPRIATE PERSONAL PROTECTIVE EQUIPMENT.

1 ROUGH OPENING PREPARATION

A. Verify the opening is plumb and level.

Note: It is critical that the bottom is level.

B. Verify the window will fit the opening.

Measure all four sides of the opening to make sure it is 3/4" larger than the window in both width and height. On larger openings measure the width and height in several places to ensure the header or studs are not bowed.

Note: 1-1/2" or more of solid wood blocking is required around the perimeter of the opening. Fix any problems with the rough opening before proceeding.

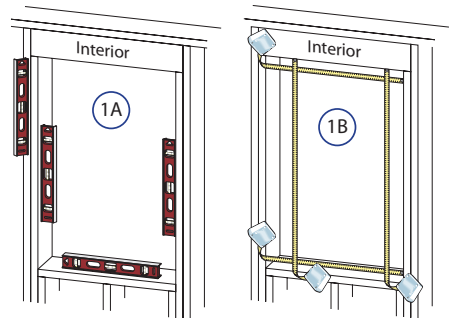

C. Cut the water resistive barrier (1C).

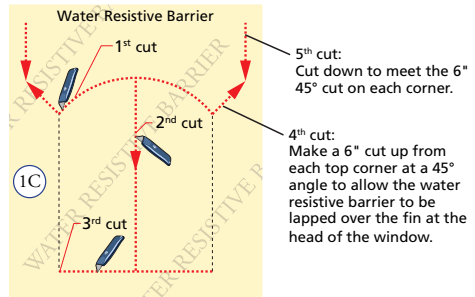
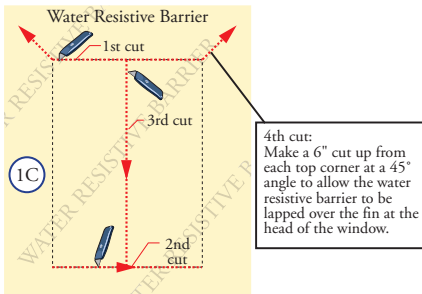

**Additional shape cut patterns at end of instruction.*

D. Fold the water resistive barrier (1D). Fold side flaps into the opening and staple to inside wall. Fold top flap up and temporarily fasten with flashing tape.

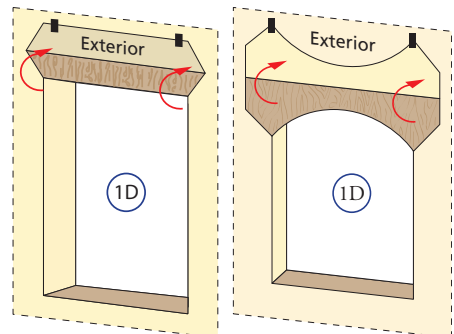

1 ROUGH OPENING PREPARATION (continued)

- E. **Apply sill flashing tape #1.** Cut a piece of flashing tape 12" longer than the opening width. Apply at the bottom of the opening as shown (1E) so it overhangs 1" to the exterior.

Note: The tape is cut 12" longer than the width so that it will extend 6" up each side of the opening.

- F. **Tab the sill flashing tape and fold.** Cut 1" wide tabs at each corner (1/2" from each side of corner) (1F). Fold tape to the exterior and press firmly to adhere it to the water resistive barrier.

- G. **Apply sill flashing tape #2.** Cut a piece of flashing tape 12" longer than the opening width. Apply at the bottom, overlapping tape #1 by at least 1". Do not allow the tape to extend past the interior face of the framing (1G).

Note: The flashing tape may not fully cover the framing members.

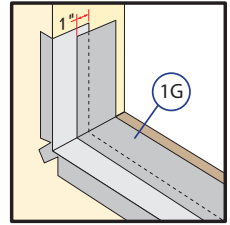
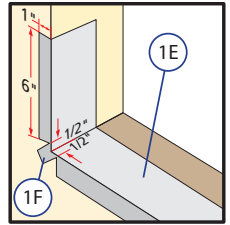

2 SETTING AND FASTENING THE WINDOW

- A. **Install and level sill spacers.** Place 1" wide by 3/8" thick spacers on the bottom of the window opening 1/2" from each side. Spacers are also required at points where windows are joined in multiple window applications. Add shims as necessary to ensure the spacers are level. Once level, attach spacers and shims to prevent movement.

Note: Improper placement of shims or spacers may result in bowing the bottom of the window.

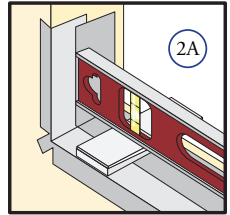

- B. **Remove plastic wrap and cardboard packaging** from window. DO NOT remove plastic shipping spacers located between the window sash and frame. The shipping spacers will help keep the window square during installation. DO NOT unlock or open the window until it is fully fastened.

Note: If screens, grilles or hardware are removed from the window at this time, label them and store them in a protected area.

- C. **Fold out installation fin to 90°.** Be careful not to remove or tear the fin corners.

Note: If the fin is not at 90°, the window will not line up correctly on the interior.

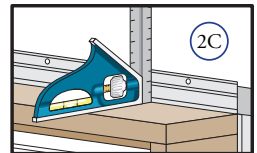

- D. **Curved Units with Fins:**

Curved Units with frame radius > 12" will be provided with fixed fin.

On windows with fixed extruded fin, drill 1/8" diameter holes in the fin every 12".

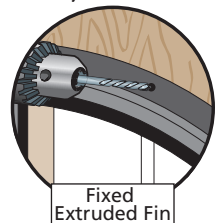

2 SETTING AND FASTENING THE WINDOW (continued)

D. Curved Units with Fins (Continued):

Curved Units with frame radius $\leq 12"$, full circle and ellipse units will be provided with a flexible non-structural fin on the curved portion of the unit.

Note: This fin is intended for flashing only, not as structural support.

Installation Clips for Structural Support:

Determine installation clip placement. Clips (provided) should be evenly spaced across the curved frame member and no more than 16" on center. Place the clips so the lip is facing up and against the installation fin. Secure each clip by driving a #6 x 5/8" corrosion resistant screws through the outer two holes of the three holes shown.

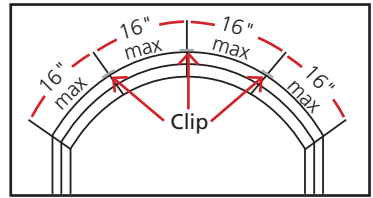
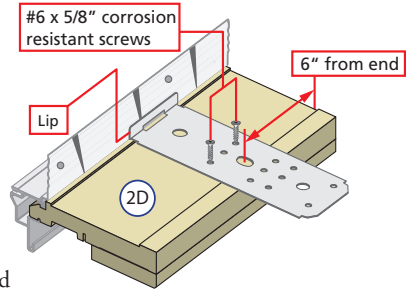

TWO OR MORE PEOPLE WILL BE REQUIRED FOR THE FOLLOWING STEPS.

- E. **Insert the window** from the exterior of the building. Place the bottom of the window on the spacers at the bottom of the opening, then tilt the top into position. Center the window between the sides of the opening to allow clearance for shimming, and insert one roofing nail in the first hole from the corner on each end of the top nailing fin. These are used to hold the window in place while shimming it plumb and square.

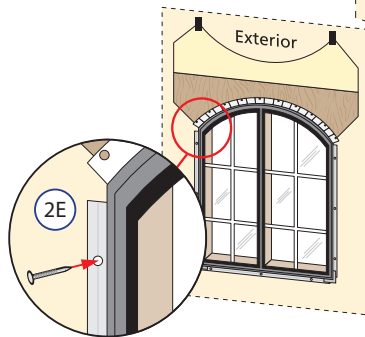
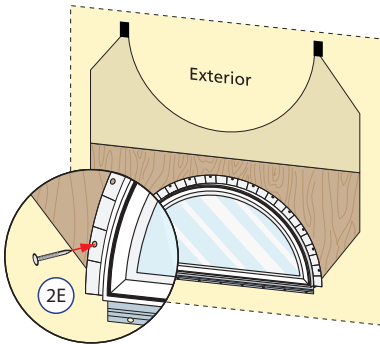
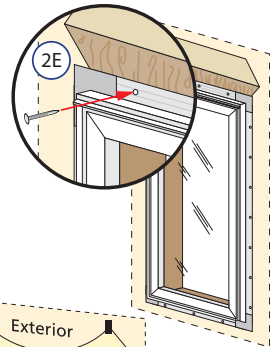

- F. **Plumb and square window.** Place shims 1" from the bottom and top of the window between the window and the sides of the opening. Adjust the shims as required to plumb and square the window in the opening. If the frame height exceeds 53", place shims at the midpoint of the window sides.

Note: Do not shim above the window or in the space between the spacers at the bottom of the window. DO NOT over shim.

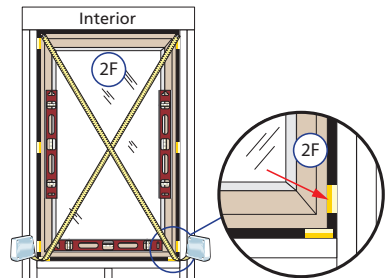

2 SETTING AND FASTENING THE WINDOW (continued)

- G. **Check the interior reveal.** Make sure the measurement from the interior face of the window to the interior face of the wall is equal at several points around the window.

Note: If the dimensions are not equal, check to make sure the fins are folded out to 90° at all points.



- H. **Check window operation** (vent units only). Unlock the window by lifting the lock handle up. Open the window by rotating the crank handle. Remove the shipping spacers. Open and close the window a few times to check for proper operation. Close and lock the window.

Note: If there are any problems with the operation of the window, recheck shim locations and adjust for plumb and square.

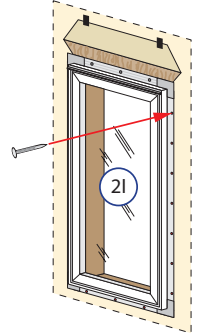

- I. **Fasten the window to opening** by driving 2" galvanized roofing nails into each pre-punched hole in the nailing fin.

Note: Make sure the fin corner is lying as flat as possible.

- J. **For units with flexible non-structural curved fin on which clips were added:** Fasten the clips to the opening by driving two #6 x 1-1/2" or longer corrosion resistant into the pre-punched holes in the clips. If clips are bent and fastened to the interior stud, install the screws as close to the bend as possible.

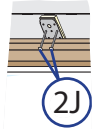

Note: DO NOT shim above the window.

- K. **For large units with frame height or frame width > 73"**; additional frame support screws must be installed at the head and jambs. On the roomside of the unit, drill 13/64" diameter clearance holes through the head and jambs at the 1/3 points of the frame.

- L. **On the roomside of the unit,** drill 13/64" diameter clearance holes through the head and jambs at the 1/3 points of the frame.

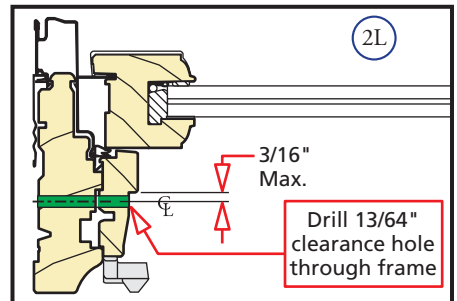
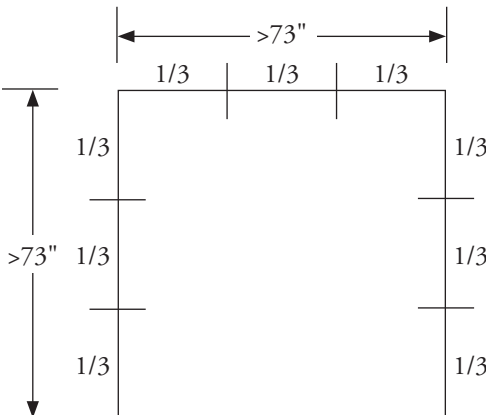

2 SETTING AND FASTENING THE WINDOW (continued)

M. Drill 1/8" x 1" deep pilot holes into the rough framing through the clearance holes in the unit frame.

N. Install #10 x 3-1/2" corrosion resistant wood screws into each of the clearance holes.

Note: Drive the screws snug but DO NOT over-tighten the screws. DO NOT bend or bow the unit frame.

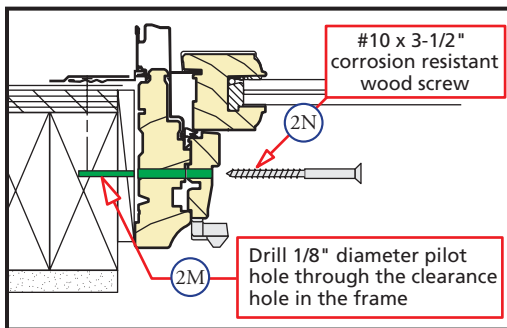

3 INTEGRATING THE WINDOW TO THE WATER RESISTIVE BARRIER

Note: The flashing tape must be applied approximately 1/2" onto the frame cladding at the jambs and head. Pre-folding the tape at 1/2" before removing the paper backing will make it easier to apply the tape correctly. If the siding is less than 1/2" thick, adjust the dimension of the fold so the exterior sealant line will cover the exterior edge of the tape.

Rectangular Units Only:

A. **Apply side flashing tape.** Cut two pieces of flashing tape 4" longer than the frame height of the window. Apply one piece to each side 1/2" onto the frame cladding, over the nailing fin and onto the water resistive barrier. The tape should extend 2" above the top of the window and 2" below the bottom of the window. Press the tape down firmly while folding down the excess tape at the top and bottom of the window.

B. **Apply top flashing tape.** Cut a piece of flashing tape long enough to go across the top of the window and extend at least 1" past the side flashing tape on both sides. Apply the tape 1/2" onto the frame cladding, over the top nailing fin as shown. Fold the overlapping tape down, and press all tape down firmly.

Note: DO NOT tape or seal the bottom nailing fin.

C. **Fold down top flap** of water resistive barrier (3C).

D. **Apply flashing tape to diagonal cuts.** Cut pieces of flashing tape at least 1" longer than the diagonal cuts in the water resistive barrier. Apply the tape covering the entire diagonal cut in the water resistive barrier at both upper corners of the window.

Note: Be sure to overlap the top corners (3D).

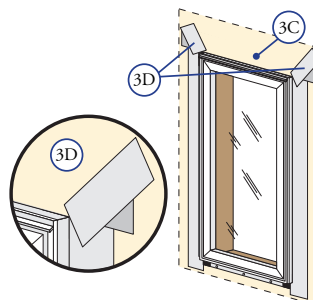
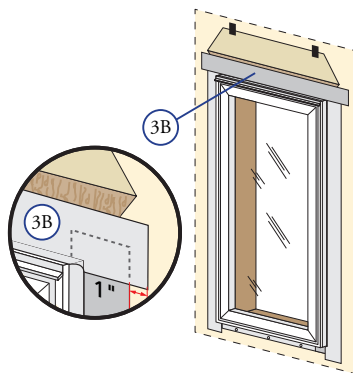
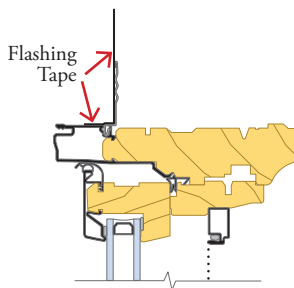

3 INTEGRATING THE WINDOW TO THE WATER RESISTIVE BARRIER (continued)

Curve Top and Angle Top Units Only:

A. Units that do not have pre-applied fin corners:

Cut four pieces of flashing tape 1-1/2" long. Apply one piece of flashing tape to each end of the sill fin so that it extends 1-1/2" past the end of the sill fin. Apply one piece of flashing tape to the bottom end of each flexible fin, beginning 1-1/2" from the end of the fin and lapping over the flashing tape that extends from the end of the sill fin.

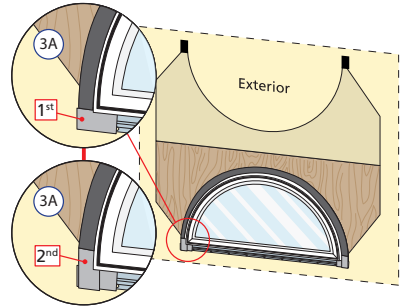

B. For Curve Top Windows:

Several pieces of flashing tape will be needed to cover the top fin. Start taping from the sides of the window working toward the peak. To determine the length of cuts, hold the tape along the radius, and cut the tape just past where it leaves the top fixed extruded fin or for the flexible fin, just past the flexible weather strip. The top tape must overlap the one beneath it in order to divert water properly. The sharper the arc of the window, the shorter the pieces of tape will be.

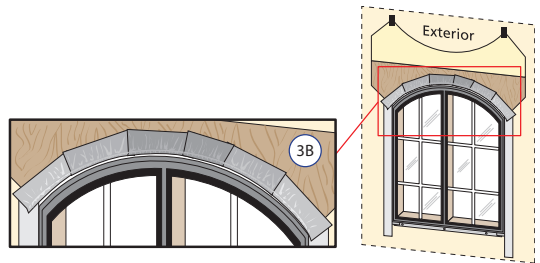

C. Apply top flashing tape to an angle top window 1/2" up onto the frame cladding, over the top fin onto the sheathing. On the short side of a trapezoid window, do not allow the side flashing tape to extend higher than what the top tape will cover. Fold the overlapping tape down, and press all tape down firmly.

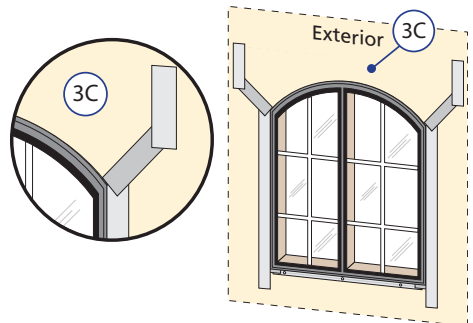

4 INTERIOR SEAL

Caution: Ensure use of low pressure polyurethane window and door insulating foams and strictly follow the foam manufacturer's recommendations for application. Use of high pressure foams or improper application of the foam may cause the window frame to bow and hinder operation.

- A. **Apply insulating foam sealant.** From the interior, insert the nozzle of the applicator approximately 1" deep into the space between the window and the rough opening and apply a 1" deep bead of foam. This will allow room for expansion of the foam and will minimize squeeze out. Apply sealant across interior surface of shims to create a continuous seal. Follow foam manufacturer's instructions.

Note: DO NOT completely fill the space from the back of the fin to the interior face of the opening.

- B. **Check window operation** (vent units only) by opening and closing the window.

Note: If the window does not operate correctly, check to make sure it is still plumb, level, square and that the sides are not bowed. If adjustments are required, remove the foam with a serrated knife. Adjust the shims, and reapply the insulating foam sealant.

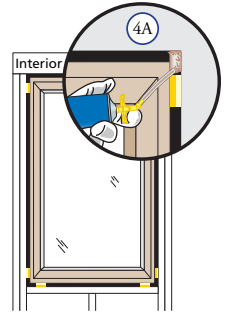

5 SEALING THE WINDOW TO THE EXTERIOR WALL CLADDING

When applying siding, brick veneer or other exterior finish material, leave adequate space between the window frame and the material for sealant. Refer to the illustration that corresponds to your finish material.

Note: The sealant details shown are standard recommendations from the sealant industry. Contact your sealant supplier for recommendations and instructions for these and any other applications.

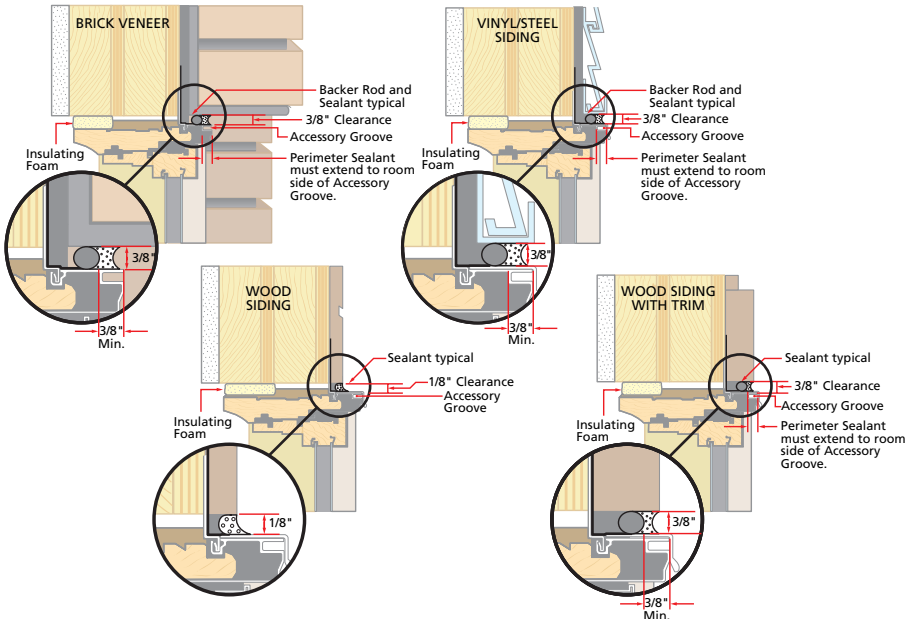

5 SEALING THE WINDOW TO THE EXTERIOR WALL CLADDING (continued)

- A. **Insert backer rod** into the space around the window approximately $\frac{3}{8}$ " deep. This should provide at least a $\frac{3}{8}$ " clearance between the backer rod and the exterior face of the window.

Note: Backer rod adds shape and depth for the sealant line.

- B. **Apply a bead of high quality exterior grade sealant** to the entire perimeter of the window.

- C. **Shape, tool and clean excess sealant.** When finished, the sealant should be the shape of an hourglass.

Note: This method creates a more flexible sealant line capable of expanding and contracting.

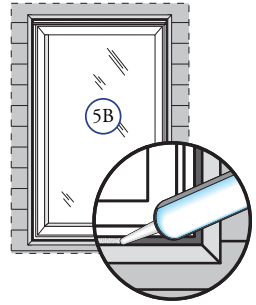

Additional cutting patterns:

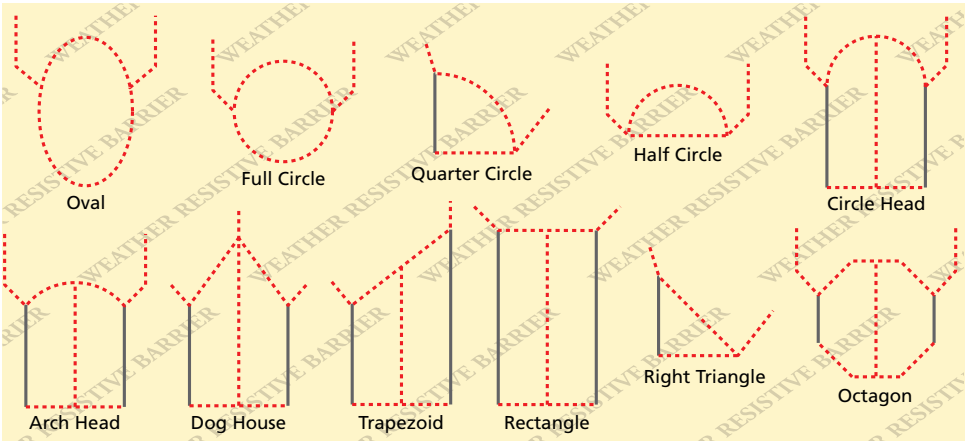

INTERIOR FINISHING

If products cannot be finished immediately, cover with clear plastic to protect from dirt, damage and moisture. Remove any construction residue before finishing. Sand all wood surfaces lightly with 180 grit or finer sandpaper. DO NOT use steel wool. BE CAREFUL NOT TO SCRATCH THE GLASS. Remove sanding dust.

Pella products must be finished per the below instructions; failure to follow these instructions voids the Limited Warranty.

- On casement and awnings, it is optional to paint, stain or finish the vertical and horizontal sash edges.
- On single-hung and double-hung, do not paint, stain or finish the vertical sash edges, any finish on the vertical sash edges may cause the sash to stick; it is optional to paint, stain or finish the horizontal sash edges.
- On patio doors, it is optional to paint, stain or finish the vertical and horizontal panel edges.

Note: To maintain proper product performance do not paint, finish or remove the weather-stripping, mohair dust pads, gaskets or vinyl parts. Air and water leakage will result if these parts are removed. After finishing, allow venting windows and doors to dry completely before closing them.

Pella Corporation is not responsible for interior paint and stain finish imperfections for any product that is not factory-applied by Pella Corporation. Use of inappropriate finishes, solvents, brickwash, or cleaning chemicals will cause adverse reactions with window and door materials and voids the Limited Warranty.

For additional information on finishing see the Pella Owner's Manual or go to www.pella.com.

EXTERIOR FINISH

The exterior frame and sash are protected by aluminum cladding with our tough EnduraClad[®] or EnduraClad Plus baked-on factory finish that needs no painting. Clean this surface with mild soap and water. Stubborn stains and deposits may be removed with mineral spirits. DO NOT use abrasives. DO NOT scrape or use tools that might damage the surface.

Use of inappropriate finishes, solvents, brickwash or cleaning chemicals will cause adverse reactions with window and door materials and voids the Limited Warranty.

CARE AND MAINTENANCE

Care and maintenance information is available in the Pella Owner's Manual. You can obtain an owner's manual by contacting your local Pella retailer. This information is also available on www.pella.com.

IMPORTANT NOTICE

Because all construction must anticipate some water infiltration, it is important that the wall system be designed and constructed to properly manage moisture. Pella Corporation is not responsible for claims or damages caused by anticipated and unanticipated water infiltration; deficiencies in building design, construction and maintenance; failure to install Pella products in accordance with Pella's installation instructions; or the use of Pella products in wall systems which do not allow for proper management of moisture within the wall systems. The determination of the suitability of all building components, including the use of Pella products, as well as the design and installation of flashing and sealing systems are the responsibility of the Buyer or User, the architect, contractor, installer, or other construction professional and are not the responsibility of Pella.

Pella products should not be used in barrier wall systems which do not allow for proper management of moisture within the wall systems, such as barrier Exterior Insulation and Finish Systems, (EIFS) (also known as synthetic stucco) or other non-water managed systems. Except in the states of California, New Mexico, Arizona, Nevada, Utah, and Colorado, **Pella makes no warranty of any kind on and assumes no responsibility for Pella windows and doors installed in barrier wall systems. In the states listed above, the installation of Pella Products in barrier wall or similar systems must be in accordance with Pella's installation instructions.**

Product modifications that are not approved by Pella Corporation will void the Limited Warranty.

INSTALLING ROTO COVER AND CRANK

Note: Finish the interior of the window and allow the window to dry before proceeding with these instructions. (To open the window for finishing, partially insert the lock handle into the jamb, unlock the unit, temporarily attach the crank handle and turn to open.)

- A. Place the cover over the operator stud and snap into place.
- B. Apply pressure to the pocket end of the cover and snap into place.
- C. Use a medium size flat-blade screwdriver to loosen the set screw in the crank handle.
- D. Slide the crank handle onto the stud. Unlock, open window, then close and lock window.
- E. Fold the crank handle down and check alignment of knob with the pocket.

Note: You may need to adjust the crank position on the stud until the correct alignment is achieved.

- F. Open the crank and tighten the set screw.
- G. After the final installation, fold the crank over and snap the knob into the pocket.

Note: Even with the window open the crank can be folded to avoid interfering with the window treatments.

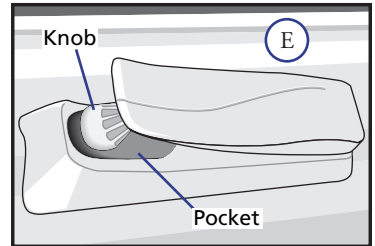
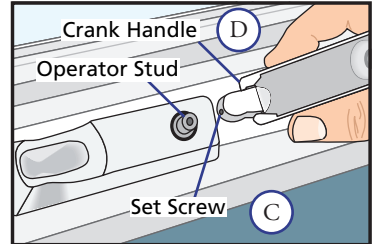
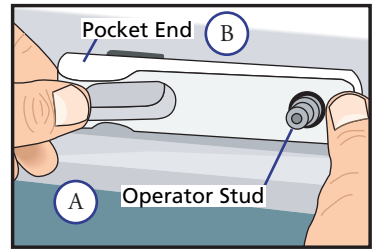

LOCK LEVER REMOVAL AND INSERTION

Note: You may want to remove the lock lever prior to finishing the window, or if it needs to be replaced with a lock lever in a different finish.

- A. Unlock and open the window.
- B. Place the lock lever in the locked position.
- C. From the exterior of the window, insert a small flat-blade screwdriver into the slot behind the lock lever.
- D. Pry the cam away from the side of the window by rotating the screwdriver a quarter turn.

Note: This will release the hook in the lever from the cam hook.

- E. Remove the lock lever by pulling it toward the interior of the building.
- F. To install a lock lever, hold it in the lock position and insert it, from the interior, into the slot until it snaps into the cam.

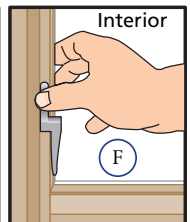
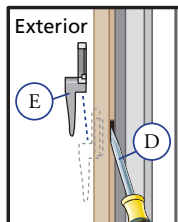
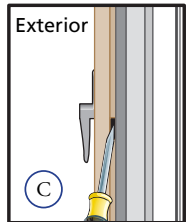
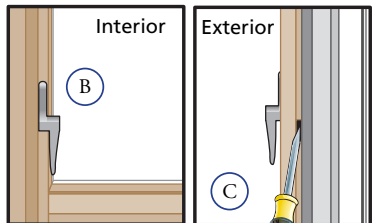

Free Manuals Download Website

<http://myh66.com>

<http://usermanuals.us>

<http://www.somanuals.com>

<http://www.4manuals.cc>

<http://www.manual-lib.com>

<http://www.404manual.com>

<http://www.luxmanual.com>

<http://aubethermostatmanual.com>

Golf course search by state

<http://golfingnear.com>

Email search by domain

<http://emailbydomain.com>

Auto manuals search

<http://auto.somanuals.com>

TV manuals search

<http://tv.somanuals.com>