



## Installation Manual

# AquaLink® RS

## PDA - Pool Digital Assistant



Pool/Spa Combination Systems and  
Pool Only/Spa Only Systems  
(Models PS4, PS6, PS8, P4, and P8)

Firmware Revision 2.6

### **WARNING**

**FOR YOUR SAFETY - This product must be installed and serviced by a professional pool/spa service technician. The procedures in this manual must be followed exactly. Failure to follow warning notices and instructions may result in property damage, serious injury, or death.**

### **ATTENTION**

This device complies with part 15 of the FCC Rules. Operation is subject to the following two conditions: (1) This device may not cause harmful interference, and (2) this device must accept any interference received, including interference that may cause undesired operation.

**NOTE:** This equipment has been tested and found to comply with the limits for a Class B digital device, pursuant to part 15 of the FCC Rules. These limits are designed to provide reasonable protection against harmful interference in a residential installation. This equipment generates, uses and can radiate radio frequency energy and, if not installed and used in accordance with the instructions, may cause harmful interference to radio communications. However, there is no guarantee that interference will not occur in a particular installation. If this equipment does cause harmful interference to radio or television reception, which can be determined by turning the equipment off and on, the user is encouraged to try to correct the interference by one or more of the following measures:

- Reorient or relocate the receiving antenna.
- Increase the separation between the equipment and receiver.
- Connect the equipment to an electrical source on a circuit different from that to which the receiver is connected.
- Consult the dealer or an experienced radio/TV technician for help.

Modifications made to this equipment, which are not authorized by the manufacturer, may void the user's authority to operate this equipment.



## Table of Contents

<p><b>Section 1. Important Safety Instructions..... 4</b></p> <p><b>Section 2. System Overview ..... 6</b></p> <p style="padding-left: 20px;">2.1 Package Contents ..... 6</p> <p style="padding-left: 20px;">2.2 System Component Specifications and Dimensions..... 7</p> <p style="padding-left: 20px;">2.3 Basic Plumbing ..... 8</p> <p><b>Section 3. Installation ..... 10</b></p> <p style="padding-left: 20px;">3.1 Power Center Mounting..... 10</p> <p style="padding-left: 20px;">3.2 High Voltage Wiring ..... 10</p> <p style="padding-left: 20px;">3.3 Low Voltage Wiring ..... 14</p> <p style="padding-left: 20px;">3.4 Heater Connection ..... 15</p> <p style="padding-left: 20px;">3.5 Temperature Sensors ..... 17</p> <p style="padding-left: 20px;">3.6 Jandy Valve Actuators..... 17</p> <p style="padding-left: 20px;">3.7 PDA Transceiver J-box Installation ..... 17</p> <p><b>Section 4. System Startup..... 19</b></p> <p style="padding-left: 20px;">4.1 Handheld Remote Programming..... 19</p> <p style="padding-left: 20px;">4.2 Restarting the System (Clear Memory) Menu ..... 22</p> <p style="padding-left: 20px;">4.3 PDA System Defaults and General Modes ..... 22</p> <p style="padding-left: 20px;">4.4 PDA Handheld Remote Menu Flow Chart ..... 24</p>	<p><b>Section 5. Troubleshooting ..... 25</b></p> <p style="padding-left: 20px;">5.1 PDA Quick Troubleshooting Guide ..... 25</p> <p><b>Section 6. Power Center Wiring Diagram ..... 27</b></p> <p><b>Section 7. Power Center PCB DIP Switch Settings ..... 28</b></p> <p style="padding-left: 20px;">7.1 DIP Switch Functions ..... 28</p> <p style="padding-left: 20px;">7.2 DIP Switch Settings for Pool and Spa Combination..... 29</p> <p style="padding-left: 20px;">7.3 DIP Switch Settings for Pool or Spa Only..... 30</p> <p><b>Section 8. General, Water Feature and Light Aux Labels ..... 31</b></p>
---	---

<b>EQUIPMENT INFORMATION RECORD</b>	
<b>DATE OF INSTALLATION</b> _____	
<b>INSTALLER INFORMATION</b> _____	
<b>INITIAL PRESSURE GAUGE READING (WITH CLEAN FILTER)</b> _____	
<b>PUMP MODEL</b> _____	<b>HORSEPOWER</b> _____
<b>FILTER MODEL</b> _____	<b>SERIAL NUMBER</b> _____
<b>PDA MODEL</b> _____	<b>SERIAL NUMBER</b> _____
<b>NOTES:</b> _____	
_____	
_____	

## Section 1. Important Safety Instructions

### READ AND FOLLOW ALL INSTRUCTIONS

#### LIRE LA NOTICE TECHNIQUE.

All electrical work must be performed by a licensed electrician and conform to all national, state, and local codes. When installing and using this electrical equipment, basic safety precautions should always be followed, including the following:

#### DANGER

To reduce the risk of injury, do not remove the suction fittings of your spa or hot tub. Never operate a spa or hot tub if the suction fittings are broken or missing. Never replace a suction fitting with one rated less than the flow rate marked on the equipment assembly.

#### WARNING

Prolonged immersion in hot water may induce hyperthermia. Hyperthermia occurs when the internal temperature of the body reaches a level several degrees above the normal body temperature of 98.6° F. The symptoms of hyperthermia include dizziness, fainting, drowsiness, lethargy, and an increase in the internal temperature of the body. The effects of hyperthermia include: 1) unawareness of impending danger; 2) failure to perceive heat; 3) failure to recognize the need to exit spa; 4) physical inability to exit spa; 5) fetal damage in pregnant women; 6) unconsciousness resulting in a danger of drowning.

#### WARNING

##### To Reduce the Risk of Injury -

- a) The water in a spa should never exceed 104°F (40°C). Water temperatures between 100°F (38°C) and 104°F (40°C) are considered safe for a healthy adult. Lower water temperatures are recommended for young children and when spa use exceeds 10 minutes.
- b) Since excessive water temperatures have a high potential for causing fetal damage during the early months of pregnancy, pregnant or possibly pregnant women should limit spa water temperatures to 100°F (38°C).
- c) Before entering a spa or hot tub, the user should measure the water temperature with an accurate thermometer since the tolerance of water temperature-regulating devices varies.
- d) The use of alcohol, drugs, or medication before or during spa or hot tub use may lead to unconsciousness with the possibility of drowning.
- e) Obese persons and persons with a history of heart disease, low or high blood pressure, circulatory system problems, or diabetes should consult a physician before using a spa.
- f) Persons using medication should consult a physician before using a spa or hot tub since some medication may induce drowsiness while other medication may affect heart rate, blood pressure, and circulation.

#### WARNING

**Risk of electric shock** - Install the power center at least five (5) feet (152.4cm) from the inside wall of the pool and/or hot tub using non-metallic plumbing. Canadian installations must be at least three (3) meters from the water.

Children should not use spas or hot tubs without adult supervision.

Do not use spas or hot tubs unless all suction guards are installed to prevent body and hair entrapment.

People using medications and/or having an adverse medical history should consult a physician before using a spa or hot tub.

#### AVERTISSEMENT

**Danger d'electrocution** - Les installations Canadiennes doivent se trouver à au moins trois (3) mètres de l'eau.

Ne pas laisser les enfants utiliser une cuve de relaxation sans surveillance.

Pour éviter que les cheveux ou une partie du corps puissent être aspirés, ne pas utiliser une cuve de relaxation si les grilles de prise d'aspiration ne sont pas toutes en place.

Les personnes qui prennent des médicaments ou ont des problèmes de santé devraient consulter un médecin avant d'utiliser une cuve de relaxation.

**⚠ WARNING**

People with infectious diseases should not use a spa or hot tub.

To avoid injury, exercise care when entering or exiting the spa or hot tub.

Do not use drugs or alcohol before or during the use of a spa or hot tub to avoid unconsciousness and possible drowning.

Pregnant or possibly pregnant women should consult a physician before using a spa or hot tub.

Water temperature in excess of 100°F/38°C may be injurious to your health.

Before entering a spa or hot tub measure the water temperature with an accurate thermometer.

Do not use a spa or hot tub immediately following strenuous exercise.

Prolonged immersion in a spa or hot tub may be injurious to your health.

Do not permit any electric appliance (such as a light, telephone, radio, or television) within 5 feet (1.5 m) of a spa or hot tub.

The use of alcohol, drugs or medication can greatly increase the risk of fatal hyperthermia in hot tubs and spas.

Water temperature in excess of 100°F/38°C may be hazardous to your health.

**⚠ AVERTISSEMENT**

Les personnes atteintes de maladies infectieuses ne devraient pas utiliser une cuve de relaxation.

Pour éviter des blessures, user de prudence en entrant dans une cuve de relaxation et en sortant.

Pour éviter l'évanouissement et la noyade éventuelle, ne prendre ni drogue ni alcool avant d'utiliser une cuve de relaxation ni quand on s'y trouve.

Les femmes enceintes, que leur grossesse soit confirmée ou non, devraient consulter un médecin avant d'utiliser une cuve de relaxation.

Il peut être dangereux pour la santé de se plonger dans de l'eau à plus de 38°C/100°F.

Avant d'utiliser une cuve de relaxation mesurer la température de l'eau à l'aide d'un thermomètre précis.

Ne pas utiliser une cuve de relaxation immédiatement après un exercice fatigant.

L'utilisation prolongée d'une cuve de relaxation peut être dangereuse pour la santé.

Ne pas placer d'appareil électrique (luminaire, téléphone, radio, téléviseur, etc) à moins de 1.5m de cette cuve de relaxation.

La consommation d'alcool ou de drogue augmente considérablement les risques d'hyperthermie mortelle dans une cuve de relaxation.

Il peut être dangereux pour la santé de se plonger dans de l'eau à plus de 38°C/100°F.

**⚠ WARNING**

To avoid injury ensure that you use this control system to control only packaged pool/spa heaters which have built-in operating and high limit controls to limit water temperature for pool/spa applications. This device should not be relied upon as a safety limit control.

**⚠ CAUTION**

A terminal bar marked "GROUND" is provided within the power center. To reduce the risk of electrical shock, connect this terminal bar to the grounding terminal of your electric service or supply panel with a continuous copper conductor having green insulation and one that is equivalent in size to the circuit conductors supplying this equipment, but no smaller than no. 12 AWG (3.3mm). In addition, a second wire connector should be bonded with a no. 8 AWG (4.115mm) copper wire to any metal ladders, water pipes, or other metal within five (5) feet (1.52m) of the tub.

**⚠ CAUTION**

A ground-fault circuit-interrupter must be provided if this device is used to control underwater lighting fixtures. The conductors on the load side of the ground-fault circuit-interrupter shall not occupy conduit, boxes, or enclosures containing other conductors unless the additional conductors are also protected by a ground-fault circuit-interrupter. Refer to local codes for complete details.











**Attention installer:** Install to provide drainage of compartment for electrical components.

**SAVE THESE INSTRUCTIONS**

## Section 2. System Overview

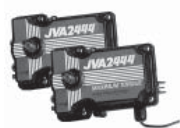
### 2.1 Package Contents

All Jandy AquaLink RS Systems come complete with the appropriate number of 3HP relays needed.

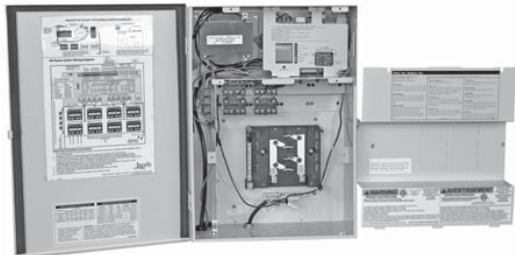
Pool Digital Assistant (PDA) System Sub-Assembly		
		
PDA Handheld Remote	Outdoor Transceiver J-box	Power Center PCB
		
Two (2) Temp Sensors, Additional Relays (Model Dependent)	Two (2) JVAs (With Pool/Spa Combination Only)	
Power Centers (Sold Separately)		
		
Standard Power Center (with mounting brackets)	Sub-Panel Power Center (with mounting brackets and circuit breaker mounting plate)	
		
PureLink Standard Power Center (with mounting brackets)	PureLink Sub-Panel Power Center (with mounting brackets and circuit breaker mounting plate)	

## 2.2 System Component Specifications and Dimensions

Table 1

<b>Specifications (USA and Canada)</b>	
<b>Power Supply</b>	120 VAC; 60 Hz; 3 A
<b>Contact Rating (Relays)</b>	High voltage - 25 A; 3HP @ 240 VAC 1½ HP @120 VAC 1500 Watts Incandescent
	Low Voltage - Class Two, 1 A @ 24 VAC
<b>Service Switch</b>	All Circuits (located at Power Center in Service Mode)
<b>Dimensions</b>	

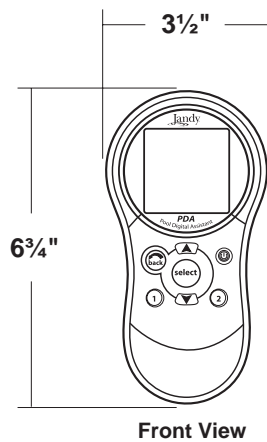

Front View



Side View

PDA Handheld Remote

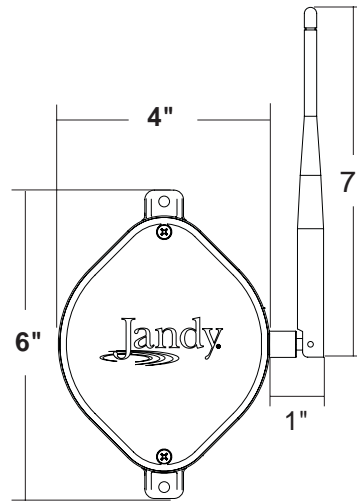

Front View

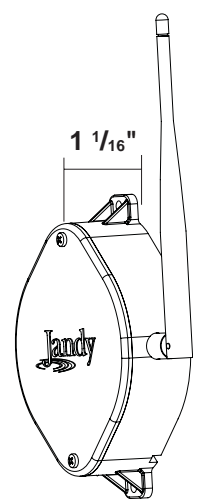

Side View (at Angle)

J-Box Transceiver

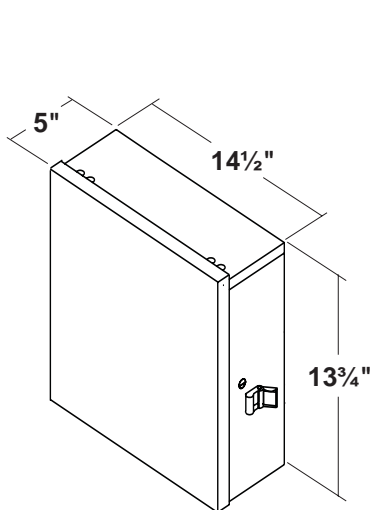

Standard Power Center

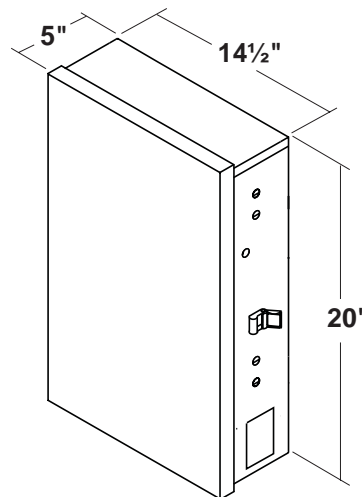

Sub-Panel Power Center

Suitable Listed Breakers (Available Locally)						
Manufacturer	CIRCUIT BREAKER					Filler Plate
	Single	Double	Twin	Quad	GFCB	
Cutler-Hammer	BR	BR	BRD	BRD	GFCB	BRFP
Murray	MP-T	MP-T	MH-T	MH-T	MP-GT	LX100FP
Siemens	QP	QP	QT	QT	QPF	QF3
Square D	HOM	HOM	HOMT	HOMT	HOM	HOMFP
Thomas & Betts	TB	TB	TBBD	TBBQ	GFB	FP-1C-TB

Note Breakers for Sub-Panel Power Center only.

## 2.3 Basic Plumbing

### 2.3.1 Plumbing for Pool and Spa Combination

The following plumbing diagrams illustrate simplified versions of standard plumbing setups for a pool and spa that share the same filter pump, filter, and heater. The intake and return Jandy Valve Actuators (JVAs) turn simultaneously so when the Spa mode is selected on the AquaLink RS PDA, water circulation switches between pool and spa (consult the *Jandy Valve Actuator Installation and Operation Manual* to ensure that the JVAs are synchronized and rotate properly). Please consult the Jandy Valve Plumbing Manual for further examples of pool/spa plumbing.

Please note that if you have a pool only or a spa only, the diagram does not apply.

**NOTE** When the filter system is shared (a Pool/Spa Combo), the spa water must be able to overflow into the pool.

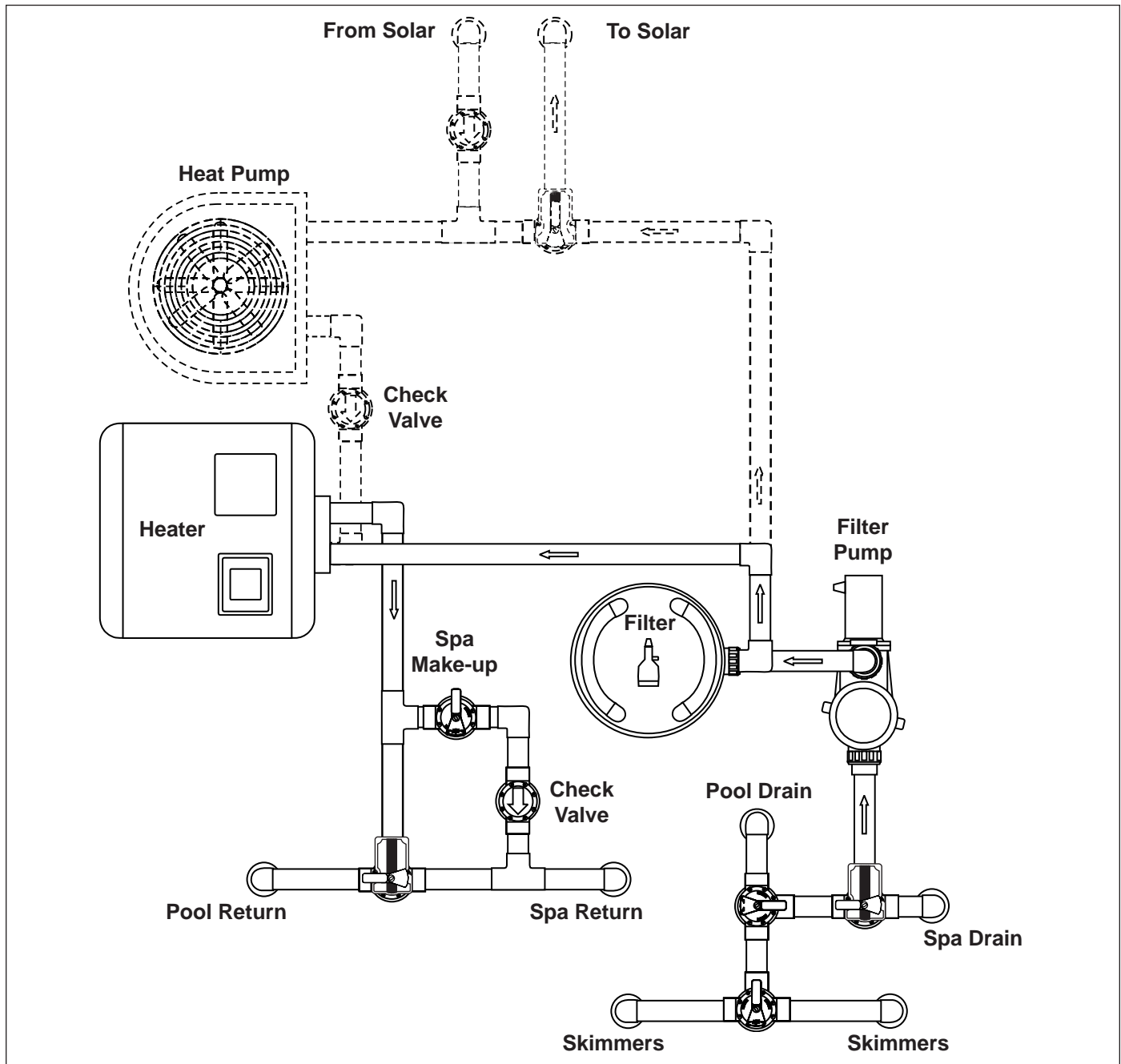



### 2.3.2 Booster Pump Pool Cleaner Plumbing

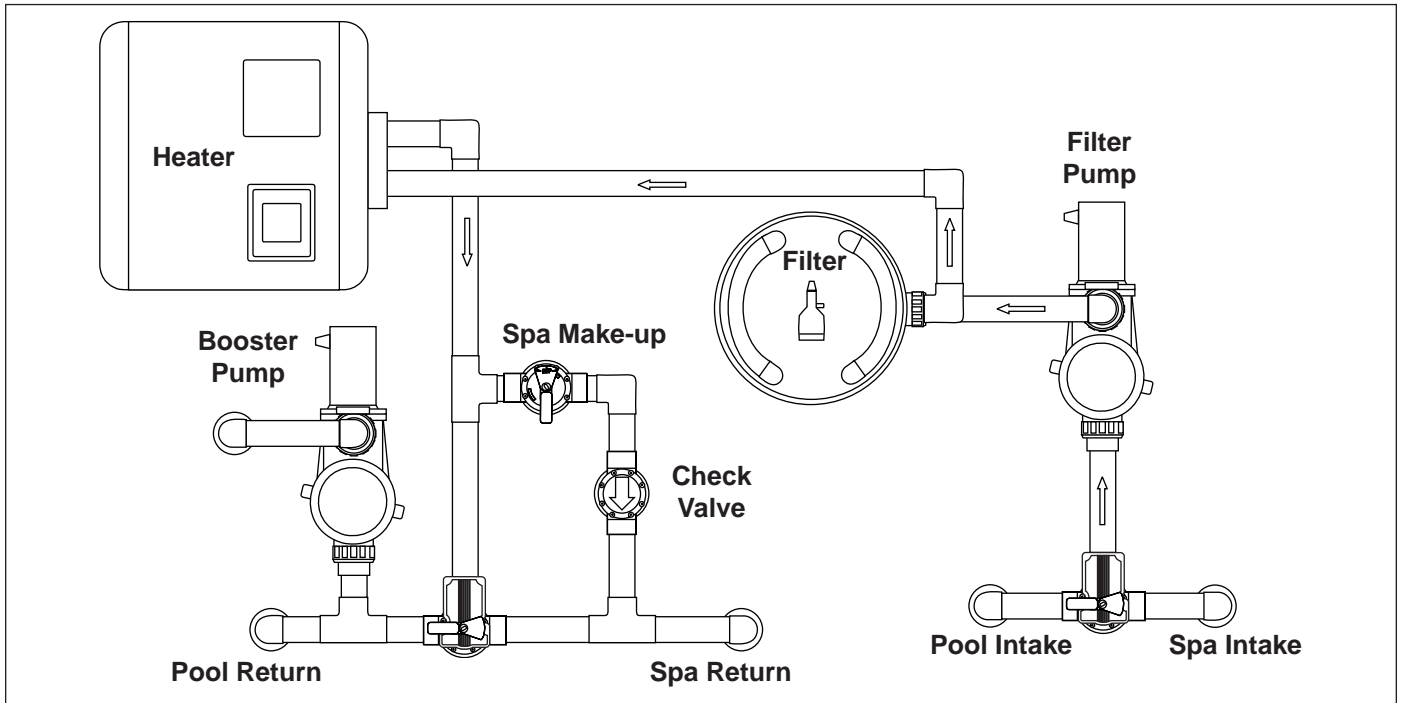

### 2.3.3 Non-Booster Pump Pool Cleaner Plumbing

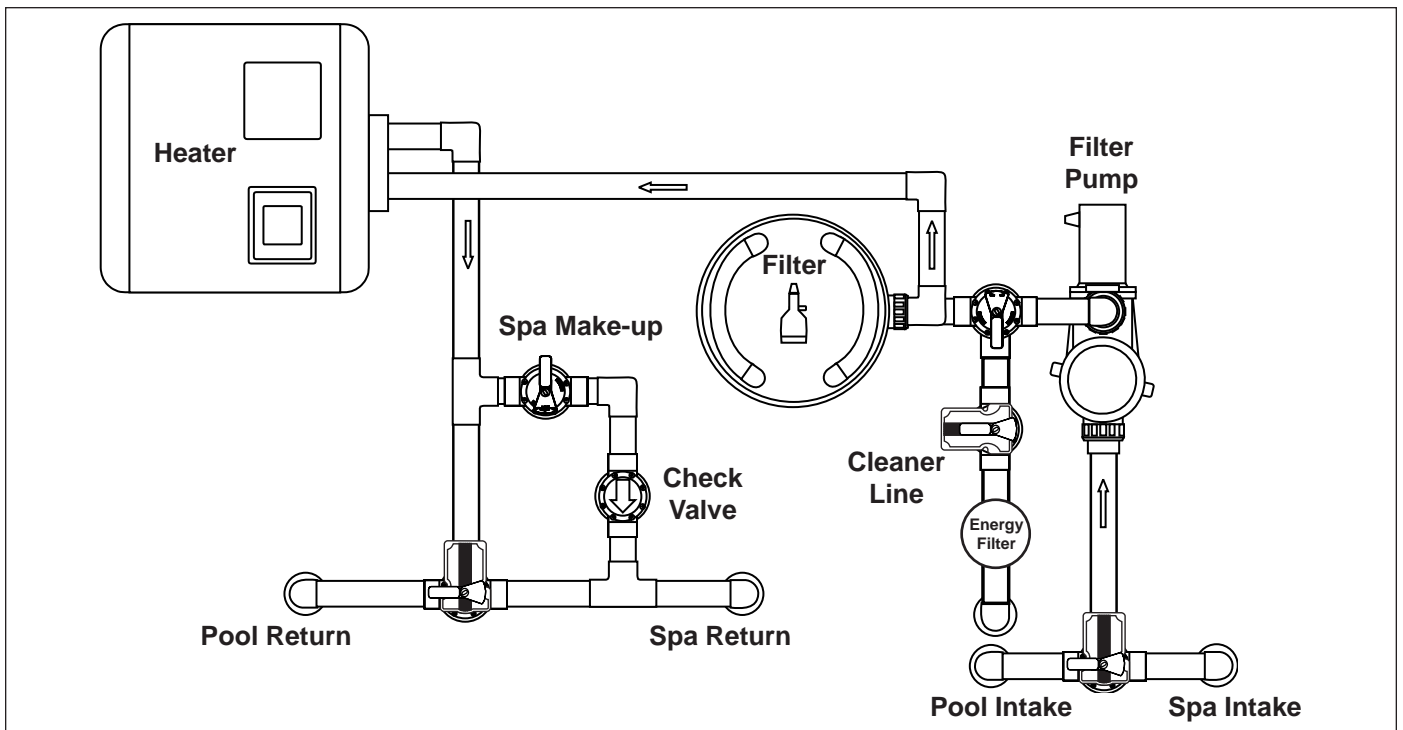

## Section 3. Installation

### 3.1 Power Center Mounting

1. The Power Center should be located at or near the equipment pad. Locate the Power Center at least five (5) feet or more away from pool/spa and five (5) feet off the ground. All national, state, and local codes are applicable.

**NOTE** For Canadian installations, the Power Center must be at least three (3) meters (9.8 feet) away from the pool/spa and 1.5 meters (5 feet) above the ground.

2. Use the mounting brackets and instructions provided with the Standard Power Center and/or Sub-Panel Power Center.
3. Sub-Panel Power Centers have special code requirements. Be sure to follow all applicable local and state codes to insure safe installation.

**NOTE** The Power Center is not to be considered as suitable for use as Service Equipment. Therefore, it is required to have the appropriate means of disconnection, circuit isolation, and/or branch circuit protection installed *upstream* of the Power Center.

### 3.2 High Voltage Wiring

#### 3.2.1 System Power

#### **⚠ WARNING**

Potentially high voltages in the AquaLink RS Power Center can create dangerous electrical hazards, possibly causing death, serious injury or property damage. Turn off power at the main circuit feeding the AquaLink RS Power Center to disconnect the Power Center from the system.

Depending on the amount of equipment being controlled, run ½" or larger conduit from the power supply panel to the bottom of the Power Center. If you are using the Sub-Panel Power Center, wire power to the appropriate breakers. Pull in appropriate wire for equipment. Each piece of equipment requires its own high voltage relay. Connect 120 volts to the Power Center terminals. Connect equipment ground(s). See Figures 1 and 2.

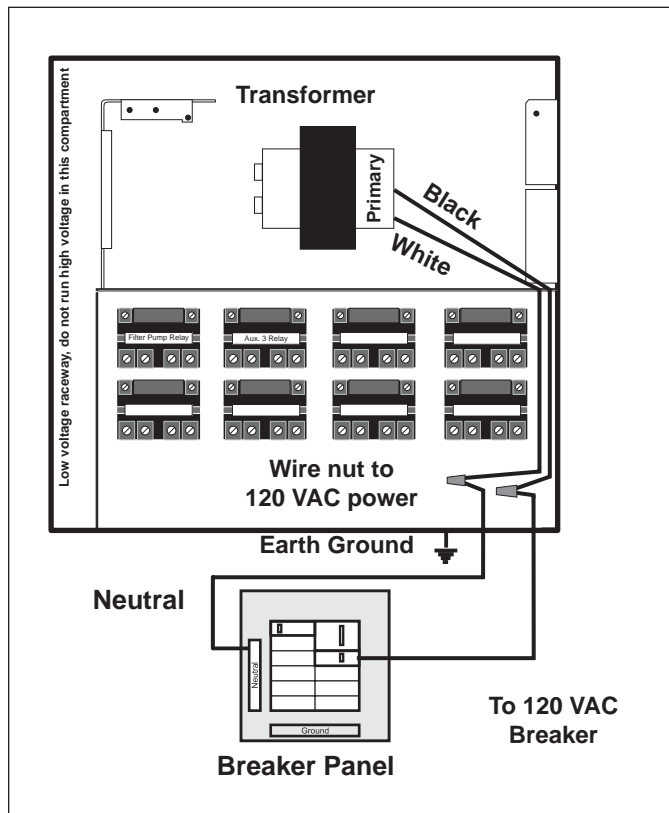

Figure 1. Standard Power Center

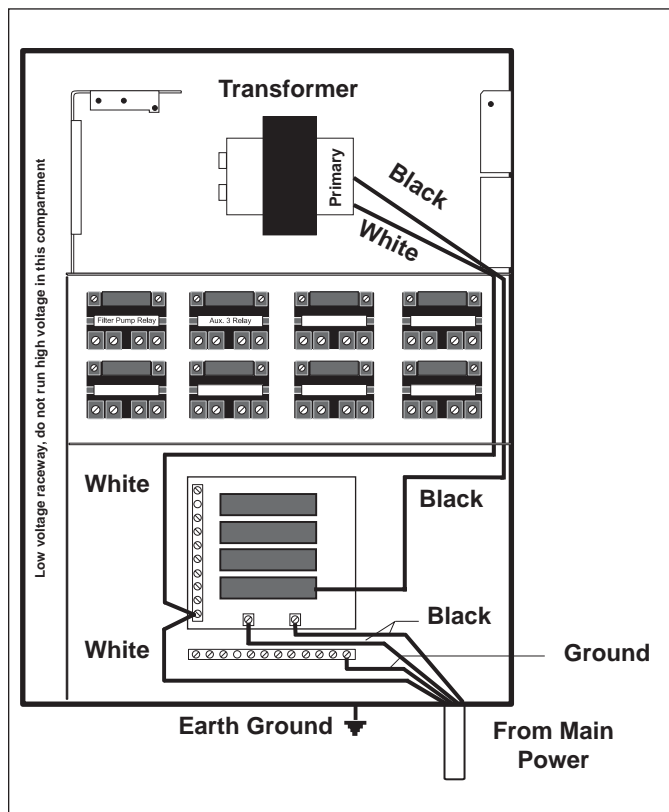

Figure 2. Sub-Panel Power Center

### 3.2.2 3HP (Standard) Relays

For each piece of **240 volt** equipment to be controlled, **connect line power to the two (2) line terminals** and **connect equipment power to the two (2) load terminals** on the same relay.

For each piece of **120 volt** equipment, **connect power to a line terminal** and **connect equipment to a load terminal** on the same relay.

**NOTE** The following are the contact ratings for 3HP (Standard) Relay. DO NOT exceed any ratings.  
 3 HP @ 240 VAC; 1½ HP @ 120 VAC; 25 Amps; 1500 Watts.

### 3.2.3 Bonding the Power Center

Install a bonding lug to the Power Center enclosure. Connect the bond lug, using a #8 solid copper core wire, to an approved earth ground (an approved ground stake, grid, or conducting metal water pipe buried to a sufficient depth). See Figure 3.

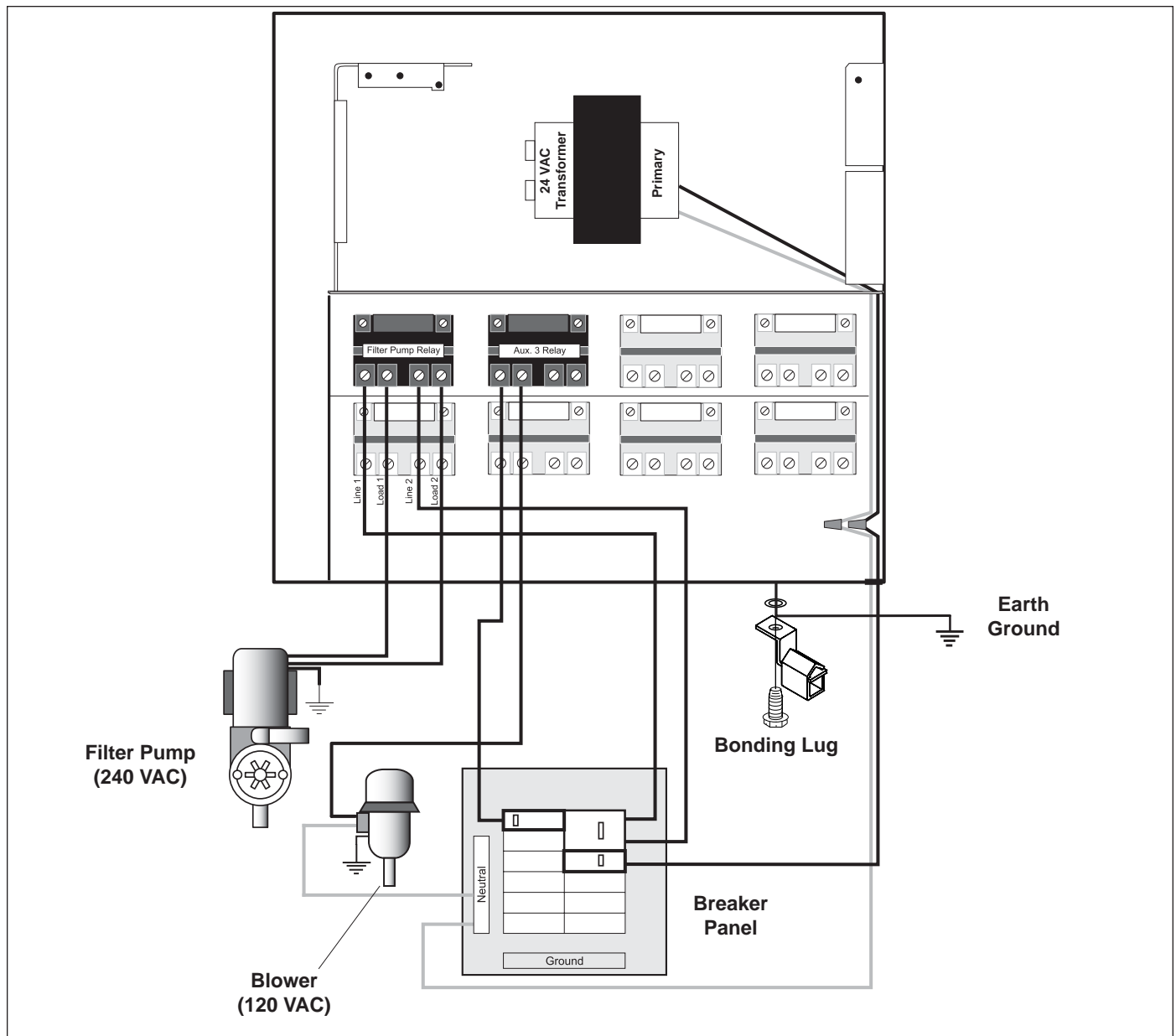

Figure 3. Standard Power Center - Bonding

### 3.2.4 Underwater Lighting GFCI Wiring

#### **⚠ CAUTION**

A Ground Fault Circuit Interrupter (GFCI) *must* be provided in high voltage pool/spa lights. **Do not use a GFCI circuit breaker.** The conductors on the load side of the GFCI circuit shall not occupy conduit, boxes, or enclosures containing other conductors unless the other conductors are also on the load side of a GFCI. Refer to local codes for complete details.

1. For a Standard Power Center, install an appropriately rated GFCI receptacle next to the breaker panel. For a Sub-Panel Power Center install an appropriately rated GFCI receptacle in the Power Center (use the knockout provided on the right side of the Sub-Panel Power Center). See Figure 4.
2. Connect neutral and hot wire (from circuit breaker) to the LINE side of the GFCI.
3. Connect neutral (white wire) and the hot (black wire) from the light to the LOAD side of the GFCI.
4. Connect ground from the light to the grounding bar inside the Power Center.

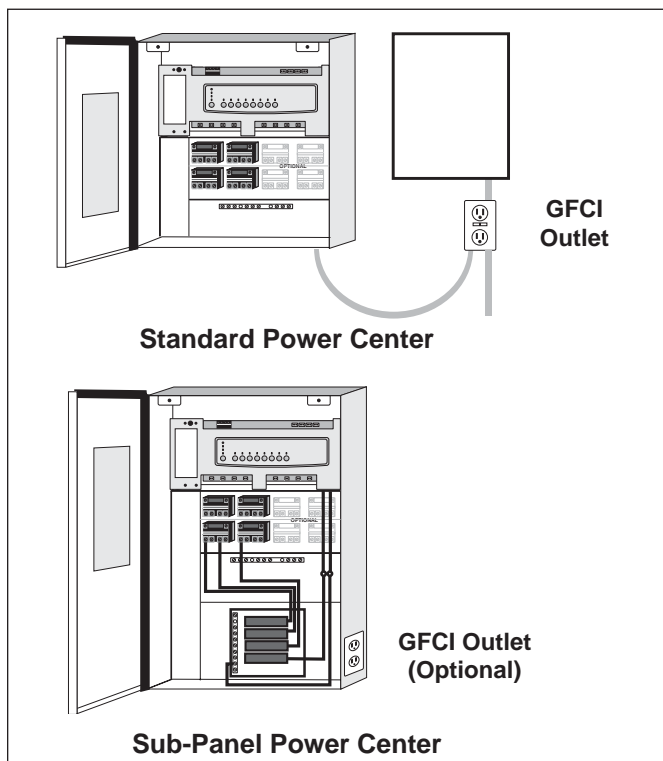

**Figure 4. GFCI Installation for Underwater Lighting**

### 3.2.5 Jandy Pool and Spa Lights Wiring

The **Jandy Pool and Spa Lights** can be wired into the Jandy AquaLink RS control system to ensure simplified operation of the lights, as well as a means to synchronize the color change function. Connect the lights to one of the auxiliary relays in the Power Center.

**NOTE** It is recommended to connect one light per relay so each light can be controlled separately. However, up to four lights can be connected on a single relay. If there are more than four lights installed on one AquaLink RS system, ensure there is more than one auxiliary relay available in the Power Center.

Refer to Figures 5 and 6 to connect the Jandy Pool and Spa Lights to the Power Center.

**NOTE** The Jandy Pool and Spa Lights are available in 120-volt and 12-volt versions. If installing a 12-volt light, a 120-volt/12-volt step-down (AC) transformer, listed/certified for the application must be used. For more information about 12-volt installations, refer to the *Jandy Digital, Color Changing, Underwater Pool and Spa Lights Installation and Operation Manual*.

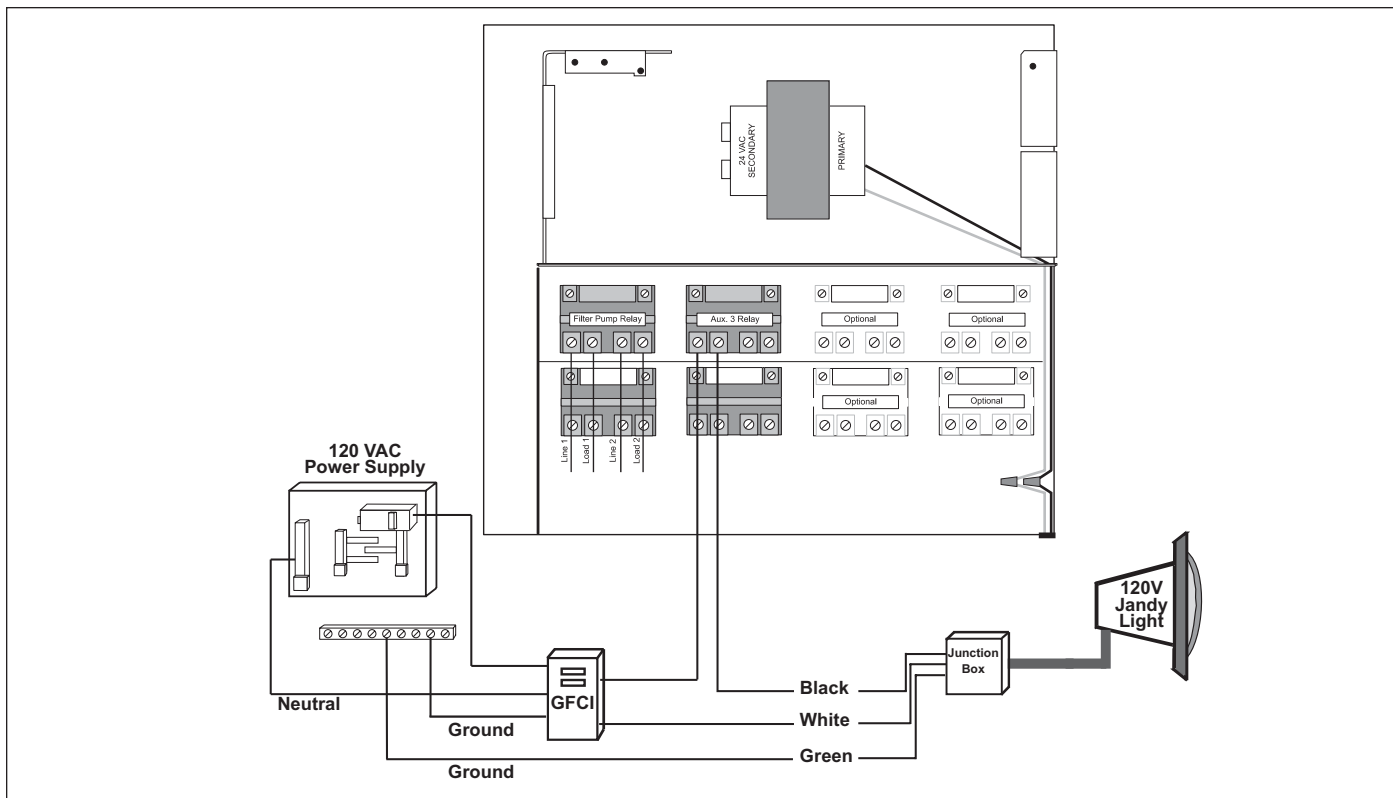

Figure 5. 120-Volt Jandy Pool and Spa Light Wiring Diagram

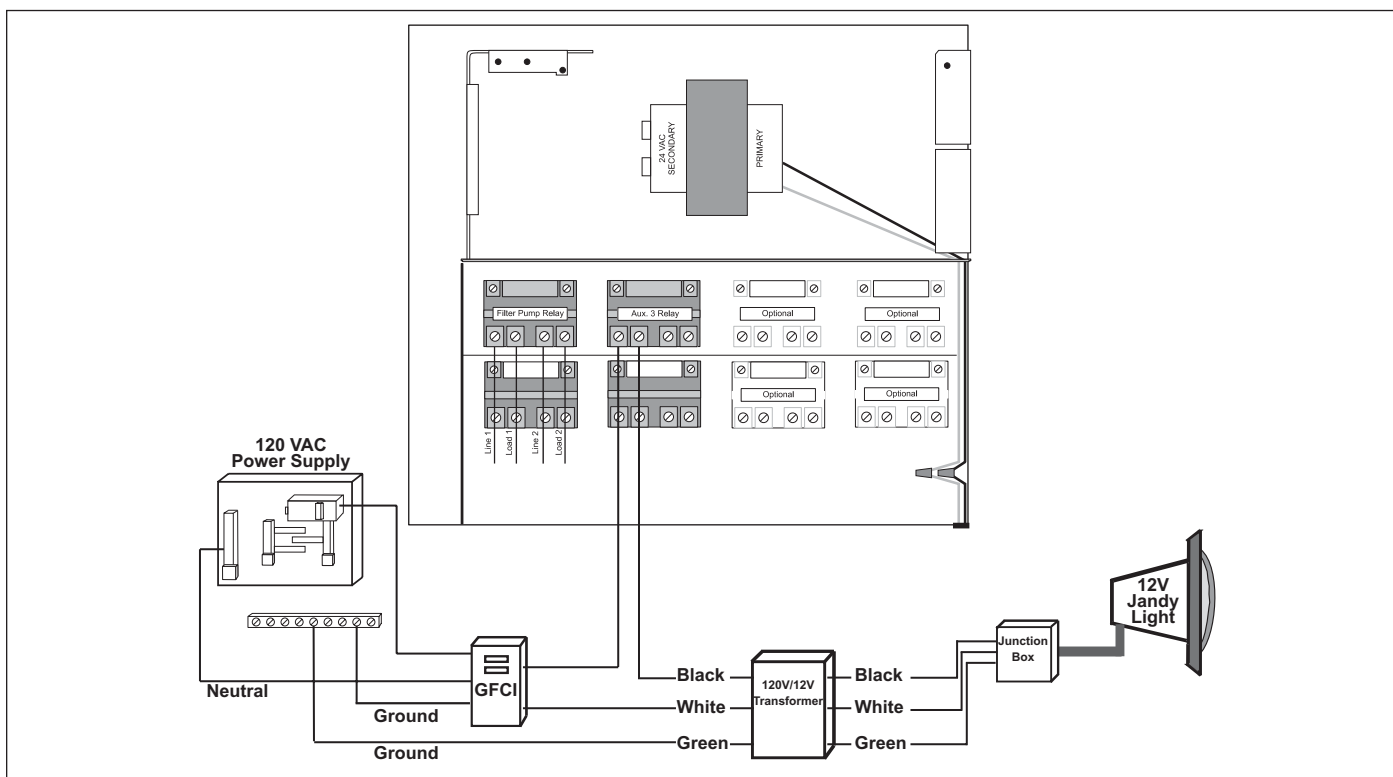

Figure 6. 12-Volt Jandy Pool and Spa Light Wiring Diagram

### 3.3 Low Voltage Wiring

#### 3.3.1 Bezel Connection

Plug the 24 VAC power plug from the transformer into its 3-pin terminal on the back of the Power Center PCB (see Figure 7). Mount the Bezel to the Power Center using the screws provided. Ensure that battery wires are kept from being pinched or damaged.

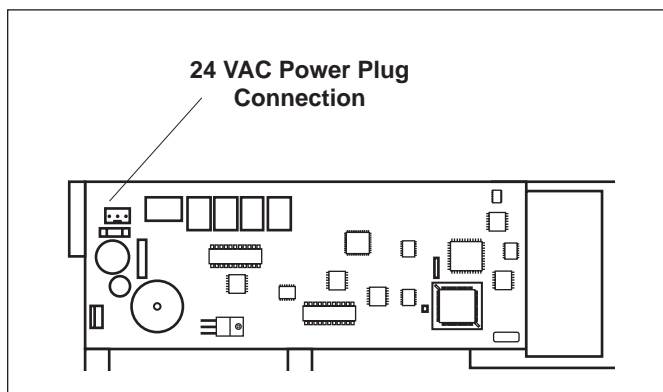
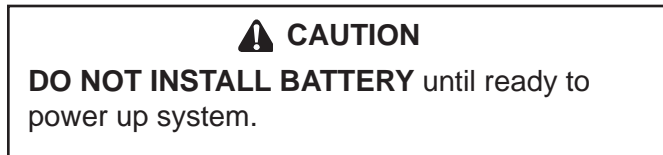

Figure 7. Power Center PCB (back view)

#### 3.3.2 PDA J-Box Cable Connection to Power Center PCB

Make provision for the cable to be run between the PDA J-box and the Power Center. **Never run high voltage and low voltage in the same conduit.** Pull cable through the knockout with the Heyco fitting and into the low voltage compartment. Strip back jacket 6". Strip each wire a 1/4" and connect to the red, 4-pin connector on the Power Center PCB. A multiplex kit may be required if there are more than two cables running to a red, 4-pin connector (see Figure 8).

**NOTE** For detailed transceiver installation, see Section 3.7.1.

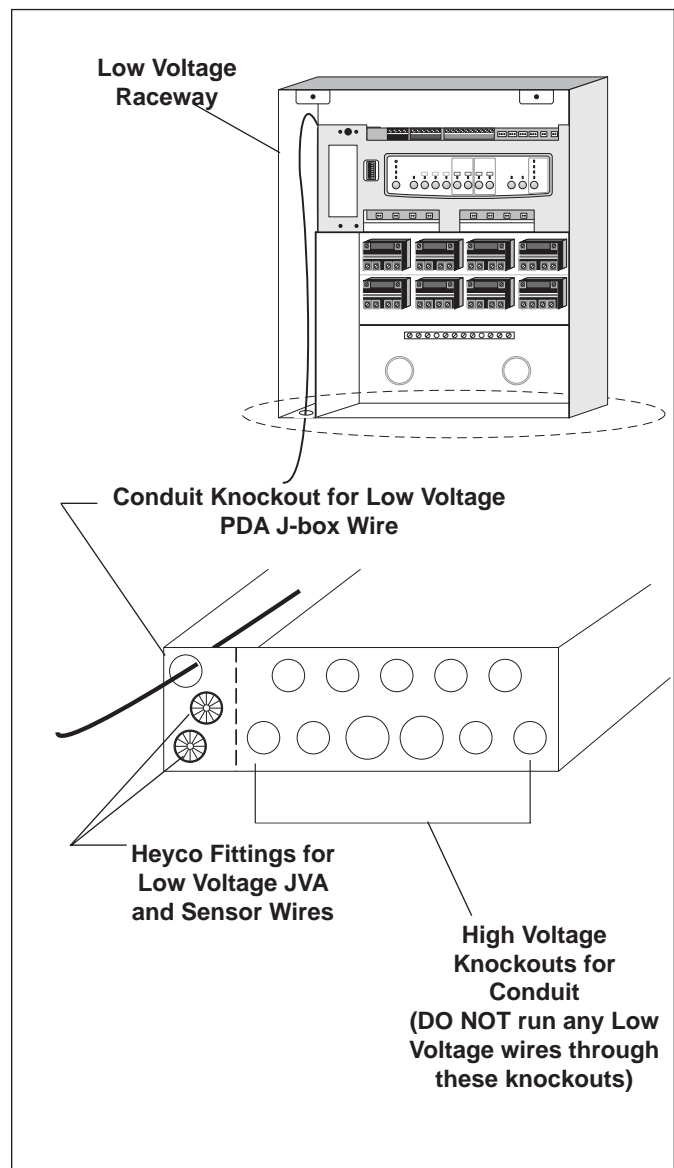

Figure 8. PDA J-Box Cable Connection to Power Center PCB

### 3.4 Heater Connection

The heater connection section applies to all heaters or heat pumps with thermostatic circuitry of 24 VAC or less (see pages 15 thru 17 for brand specific installation).

**NOTE** If you are connecting a heater with thermostatic circuitry of 120 VAC or greater, do not connect to the green, 10-pin Terminal Bar. Instead, connect the heater to a high voltage relay in the Power Center and plug the spare relay into the Electric Heater relay socket located on the upper right hand corner of the Power Center PCB.

#### 3.4.1 Jandy Brand Heater Connections

1. Connect two #14 gauge wires, designed for use in hot environments, to the #1 and #2 terminals on the green, 10-pin Terminal Bar.
2. Connect the other ends of the #14 gauge wires from Step 1 to the Fireman's Switch terminal bar in place of the factory installed wire loop.
3. Do not disconnect high limit or pressure switches.
4. Turn the heater thermostat(s) to maximum setting.
5. Turn the heater switch to the ON position. For dual thermostat heaters turn switch to Spa position.

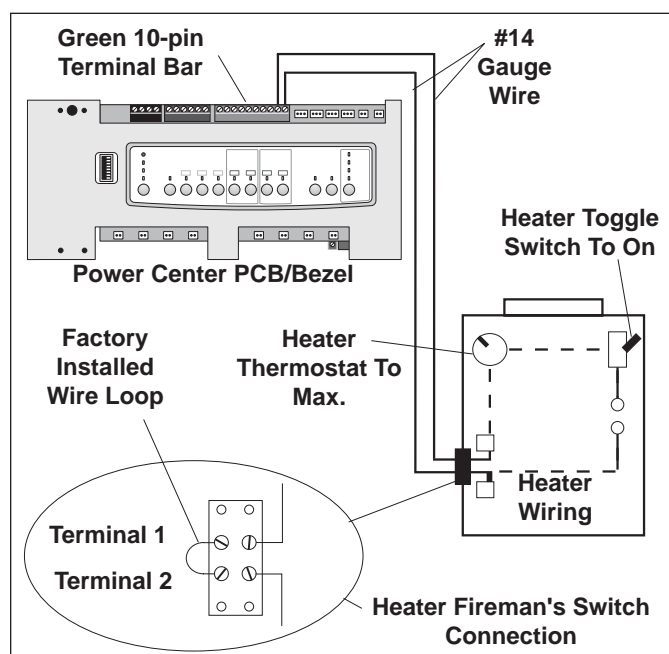

Figure 9. Lite2 Heater Connection

#### 3.4.2 Guidelines for Sophisticated Diagnostic Communication to LX Heaters

1. Remove the LX GUI from the heater.
2. Confirm the LX and AquaLink RS software revisions are compatible (see table).
3. Run a 4-conductor cable from the LX GUI red, 4-pin connector to the RS power Center red, 4-pin connector (see Figure 10).

LX Software Revision	AquaLink RS Software Revision
C10, C11 or later	PDA 1.0 or later

**NOTE** If connecting more than two (2) items to the RS Power Center red, 4-pin connector, a Multiplex PCB is required.

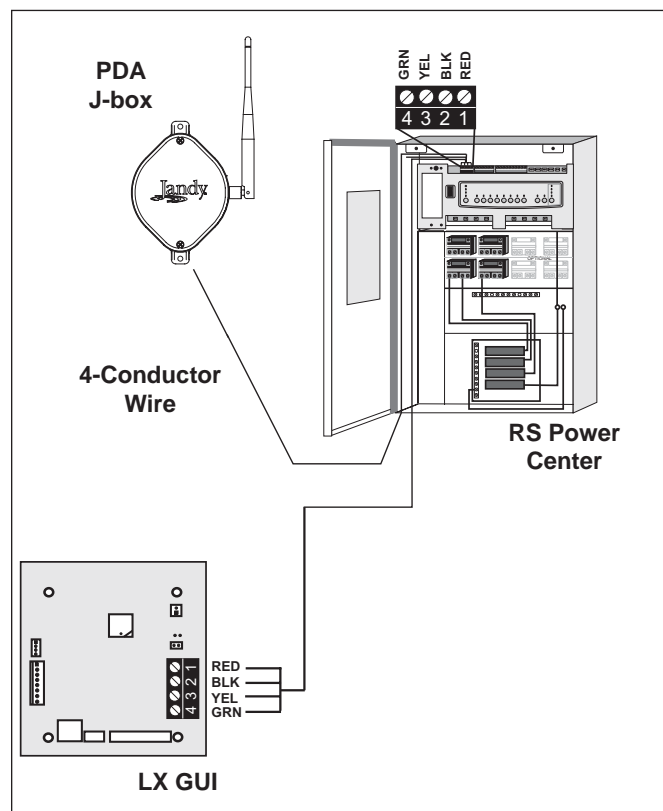

Figure 10. LX Heater Connection to Power Center

#### 3.4.3 Other Brands Heater Connections

To set up heater connections on heaters manufactured by Hayward, Pentair, and Raypak, please refer to the Installation Manual provided with these heaters.

### 3.4.4 Guidelines for a Gas Heater and a Jandy AE Series Heat Pump/Chiller Installation

**NOTE** The following steps provide the procedure for installing a Jandy AE Series Heat Pump.

1. Install a fixed resistor, with a value of 2.2K Ohms, in the solar sensor terminals #3 and #4 of the green, 10-pin terminal bar of the AquaLink RS Power Center (see Figure 16).
2. To run the wires from the Heat Pump, remove the 5 screws that attach the service/wiring cover panel to the heat pump (see Figure 16).

**NOTE** One end of the wiring reserved to run into the conduit connection labeled "Low Voltage Connection", located on the lower right hand side of the heat pump (see Figure 16).

3. Run the wires from the Heat Pump control panel through the wiring conduit located on the outer right hand side of the Heat Pump.

4. Connect the Heat Pump to a standard relay, then connect the relay to the solar pump output on the PCB. Set the time to 11:59 PM; at 12:00 AM, the AquaLink RS will auto-relabel Solar as Heat Pump. Otherwise, the AquaLink RS will auto-relabel Solar as Heat Pump within 24 hours.
5. The Solar Button will activate the heat pump/chiller and the Pool and/or Spa Heater Buttons will activate the gas heater. In this manner the pool or spa can be heated or chilled by the heat pump, the gas heater or both.

**NOTE** To program the Heat Pump control panel, refer to the *Jandy AE Series Heat Pump Manual*.

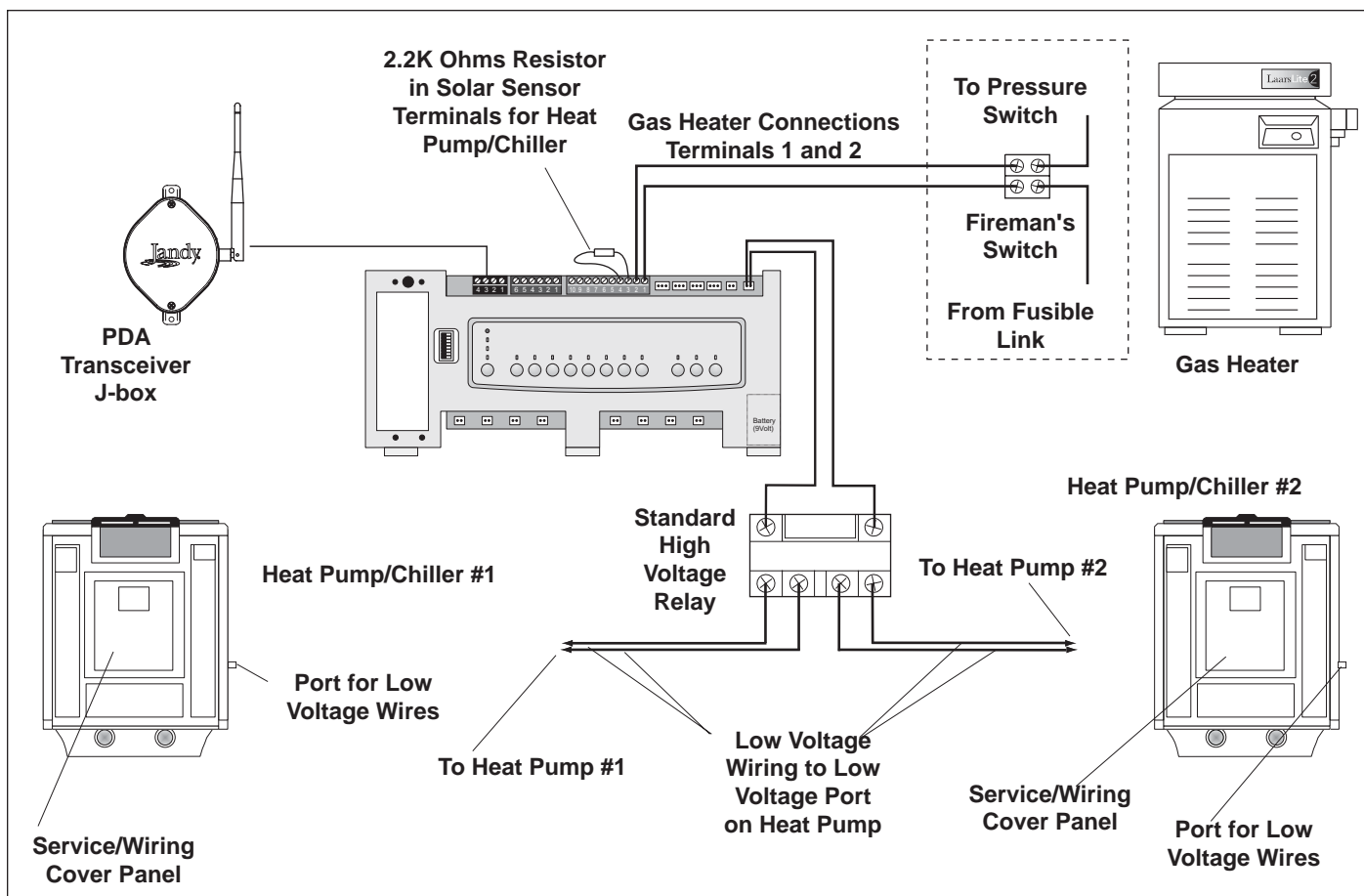

Figure 16. Heater and Heat Pump/Chiller Wiring



### 3.5 Temperature Sensors

1. Drill 3/8" hole in pipe between filter pump and filter and install the **Water Temperature Sensor** per instructions (make certain the o-ring is in place).
2. Install **Air Temperature Sensor** outside the Power Center can, not in direct sunlight and away from motors and other heat sources.
3. Install **Solar Temperature Sensor** (optional) adjacent to solar panels.
4. Run the wire to the Power Center, through the low voltage raceway. Cut off excess wire. Strip the wire jacket back 6", then strip each wire 1/4". Connect sensor wires to the green, 10-pin terminal bar (see Figure 17).

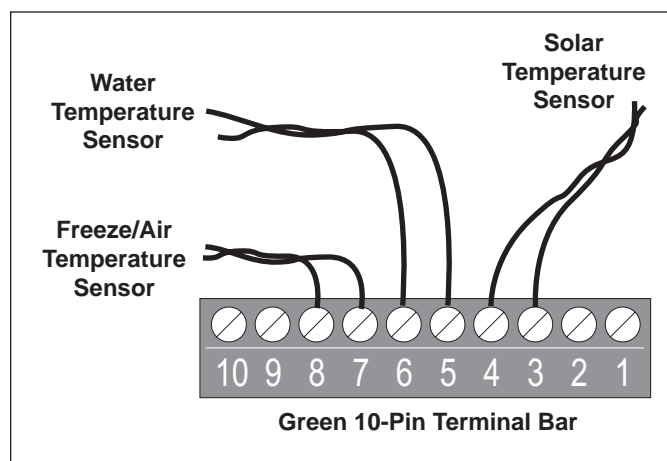

Figure 17. Temperature Sensor Wiring for a Pool/Spa Combination

### 3.6 Jandy Valve Actuators

**NOTE** Mount the JVAs according to the *Jandy Valve Actuator Installation and Operation Manual*.

JVA cable is type SJW-A marked water resistant class 3 cable and does not require conduit. Knockouts and Heyco fittings are provided in the Low Voltage Raceway.

1. Route the JVA wire to the Power Center.
2. Run the wire through the low voltage raceway and plug the JVA connectors into their proper sockets (see *Section 6. Power Center Wiring Diagram*). Verify that the JVA on the suction plumbing is connected to the Intake JVA Socket, and the discharge plumbing is connected to the Return JVA Socket.

**NOTE** Do not coil the JVA wires inside Power Center. To shorten the wire, remove the JVA cover and disconnect the wire. Shorten, strip, and reconnect.

3. For alternate plumbing configurations the JVA cam settings can be adjusted as needed. See the *Jandy Valve Actuator Installation and Operation Manual, Cam Setting Chart* for proper settings.

### 3.7 PDA Transceiver J-box Installation

**Installation Considerations.** The transceivers will transmit through walls and around corners. Steel framing, aluminum siding, wrought iron, cyclone fences, leaded glass, and other 900 MHz frequency items may inhibit/prevent communication between the AquaLink RS PDA Handheld Remote and the Power Center. *The transceivers do not require line of sight to communicate.* To optimize communication, install transceivers in a location that minimizes interference.

#### 3.7.1 Outdoor Transceiver J-box Installation

1. Turn off all power to the Power Center.
2. Mount the Outdoor Transceiver J-box at least 6' above the ground and at least 8' from an air blower (see Figure 18).

**NOTE** To improve performance of the transceiver, mount the J-box more than 6' above the ground.

3. Open the door to the Power Center and remove the dead panel.
4. Feed the four conductor wire into the Power Center through the low voltage raceway.
5. Cut off the excess wire. Strip the jacket back 6" and strip the individual wires approximately 1/4". Connect the four conductor wire to the red terminal bar on the Power Center PCB.
6. Install the dead panel to the Power Center and restore all power.

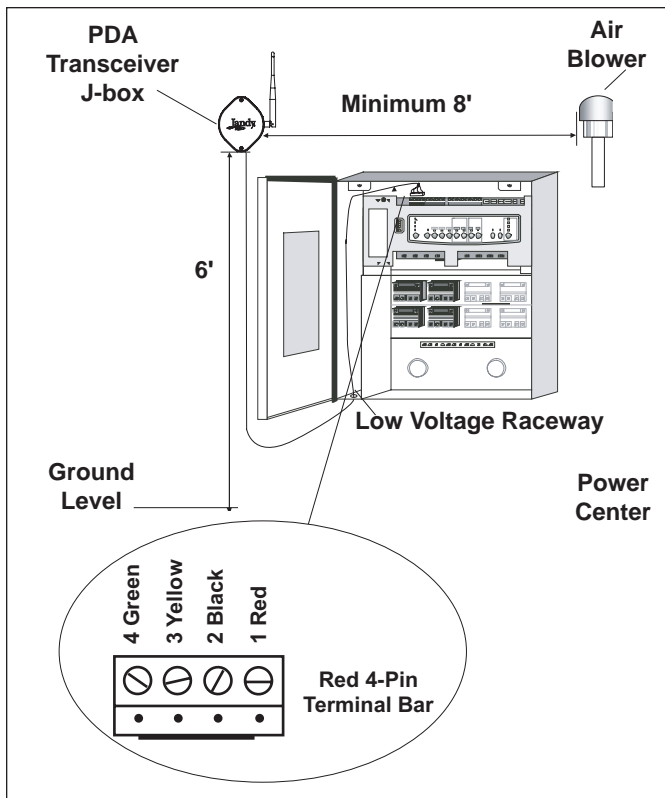

Figure 18. Outdoor Transceiver J-box Installation

### 3.7.2 PDA Handheld Remote Installation

1. Remove the Handheld Remote from the packaging.
2. On the back of the Handheld Remote, loosen and remove the two (2) screws that secure the cover for the battery chamber (see Figure 19).

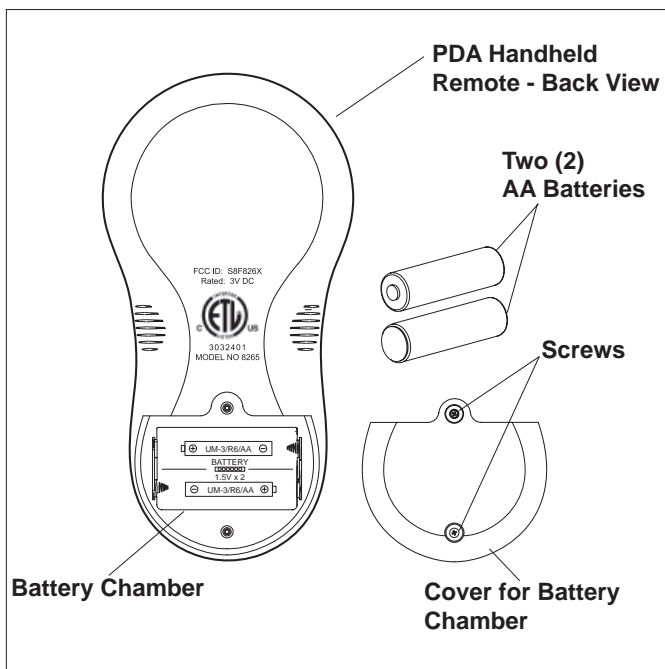

Figure 19. Battery Installation on Handheld Remote

3. Install two (2) AA batteries. Ensure that the polarity is correct.
4. Re-install the cover for the battery chamber and secure with the two (2) screws removed in Step 2.

### 3.7.3 Changing the Frequency Channel

If your AquaLink RS PDA system is turning items on or off at undesigned times, another AquaLink RS PDA system may be in close proximity using the same or similar frequency channel. To prevent unwanted operation the channel for your AquaLink RS PDA system can be changed. The Power Center Transceiver and the PDA Transceiver J-box **must be set to the same RF channel**.

1. At the Transceiver J-box, remove the cover to expose the PCB (see Figure 20).

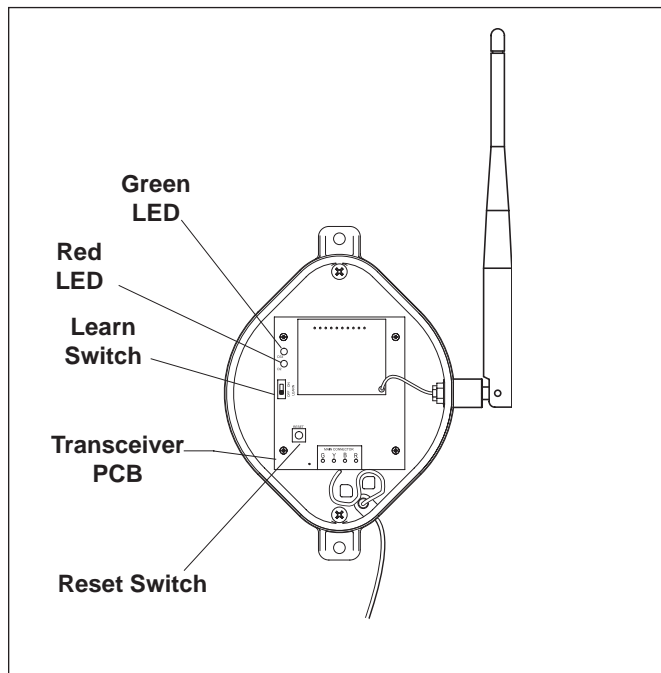

Figure 20. PDA Transceiver J-Box - Internal View

2. On the PDA Handheld Remote, press and hold both the UP and DOWN arrows simultaneously for three (3) seconds. After 3 seconds, the CHANNEL SETUP screen appears (see Figure 21). Select a channel.

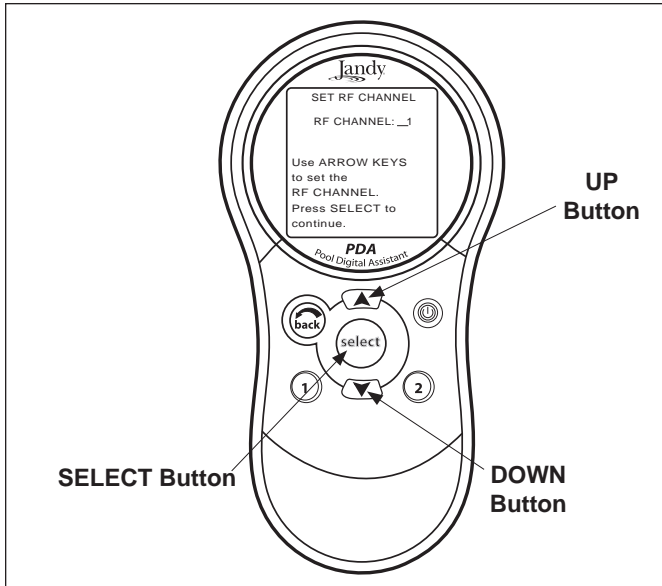

Figure 21. PDA Handheld Remote Channel Setup and Buttons

3. Use the UP and DOWN buttons to highlight the desired RF channel. Then press SELECT.
4. When the RF channel is selected, the following message appears on the PDA display screen:  
**Set slide switch on J-Box PCB to the LEARN MODE.**
5. At the PCB in the Transceiver J-box, slide the Learn Switch to LEARN (ON). See Figure 22.

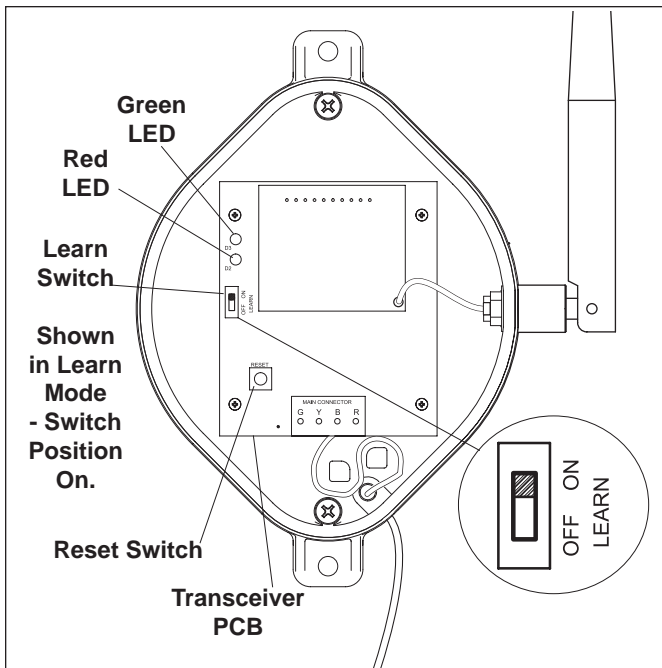

Figure 22. Transceiver J-box PCB Learn Switch

6. On the PDA Handheld Remote display screen, a prompt will appear with instructions to slide the J-box Learn Switch out of LEARN (OFF) and to press the J-box Reset Switch.
7. At the PCB in the Transceiver J-box, slide the Learn Switch out of LEARN and press the Reset Switch. The Red and Green LEDs on the J-box will blink simultaneously (see Figure 22).

## Section 4. System Startup

### 4.1 Handheld Remote Programming

#### 4.1.1. Basic Programming Menu

To set a particular piece of equipment to turn on and off at predetermined times, highlight MENU and press SELECT (see Figure 23). Highlight PROGRAM and press SELECT. Use the UP or DOWN buttons to highlight the equipment (for example, Filter Pump) then press SELECT. Follow the on-screen prompts. Use the UP or DOWN buttons to pick each number, starting with ON hours, press SELECT to enter and move on to the next item to change, including picking what day(s) the program will run. If you make a mistake, use the BACK button to return to a number. If the program is already entered, highlight CHANGE PROGRAM and step through to the entry that should be corrected.

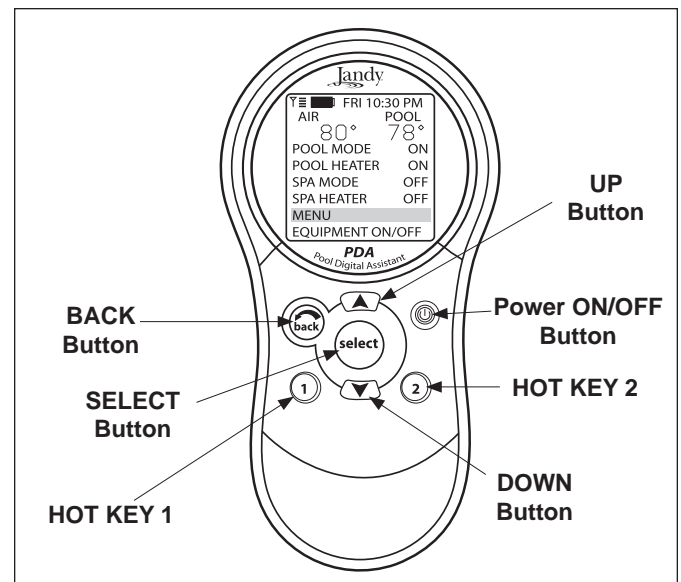

Figure 23. PDA Handheld Remote Buttons

### 4.1.2 Set the Time Menu

To set the time, highlight the MENU and press SELECT. Highlight SET TIME and press SELECT (see Figure 24). Use the UP or DOWN button to set the values. Press SELECT to continue.

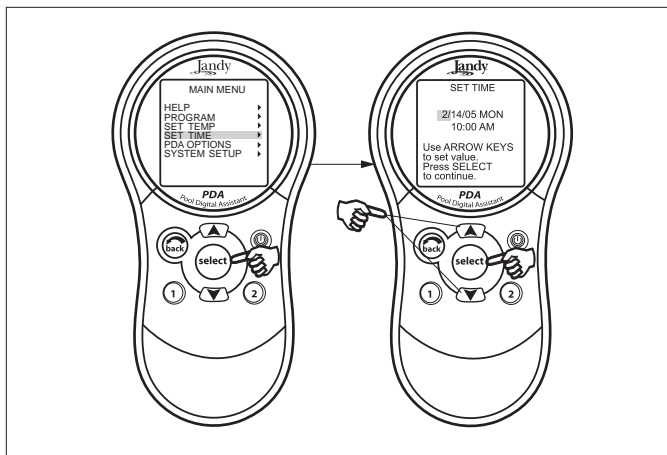

Figure 24. Set Time Menu

### 4.1.3 Set the Temperature Menu

**Pool/Spa Combination** - Highlight MENU and press SELECT. Highlight SET TEMP and press SELECT (see Figure 25). Use the UP or DOWN button to highlight either POOL or SPA and press SELECT. Use the UP or DOWN button to increase or decrease the temperature and press SELECT. Use the BACK button to return to the main screen.

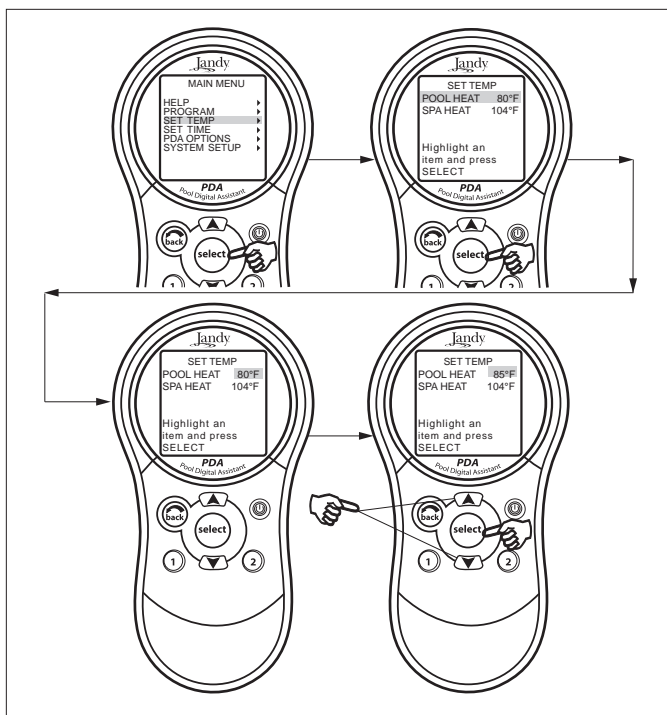

Figure 25. Set Temperature Menu - Pool/Spa Combination

**Pool/Spa Only** - Highlight MENU and press SELECT. Highlight SET TEMP and press SELECT (see Figure 26). The message *TEMP1 must be higher than TEMP2* is displayed. Highlight TEMP1 and press SELECT. Use the UP or DOWN button to increase or decrease the temperature and press SELECT. Highlight TEMP2 and press SELECT. Use the UP or DOWN button to increase or decrease the temperature and press SELECT. Use the BACK button to return to the main screen.

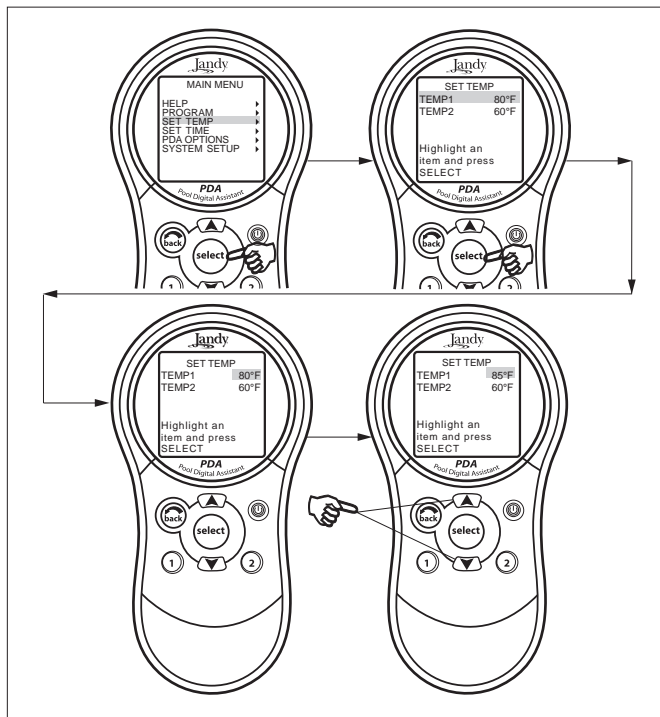

Figure 26. Set Temperature Menu - Pool/Spa Only

### 4.1.4 Label Auxiliary Functions Menu

Highlight MENU and press SELECT. Highlight SYSTEM SETUP and press SELECT (see Figure 27). Highlight LABEL AUX and press SELECT. Highlight the AUX you want to label and press SELECT. Highlight GENERAL, LIGHT, WATERFALL or CUSTOM LABEL and press SELECT. Choose a name within these categories by using the UP or DOWN button. Press SELECT when you find the correct label. Choose CUSTOM to type in your own labels.

**NOTE** The Auxiliary labels AIR BLOWER and FILL LINE have an automatic 30 minute runtime. If DIP switch 1,2 or 3 are on, auxiliaries 1, 2 and 3 are labeled CLEANER, LOW SPEED and SPILLOVER respectively and cannot be relabeled.

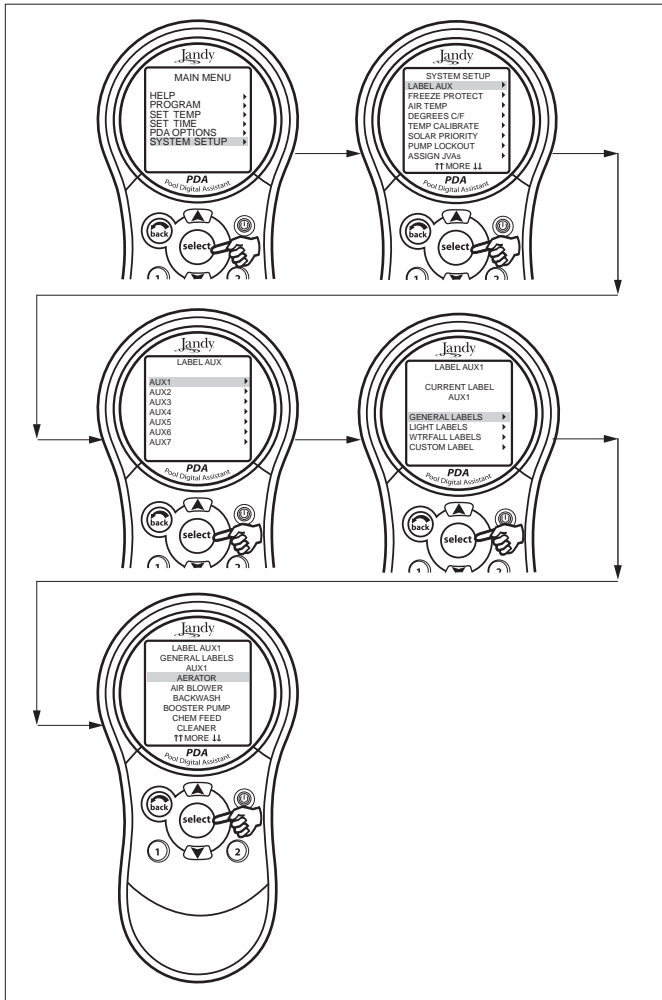

Figure 27. Label Aux Menu

### 4.1.5 Set Freeze Protection Menu

Highlight MENU and press SELECT. Highlight SYSTEM SETUP and press SELECT (see Figure 28). Highlight FREEZE PROTECT and press SELECT. Use the UP or DOWN button to change the temperature. Once the temperature is set press the SELECT button to move to the next screen to assign freeze protection to a selected piece of equipment. Highlight a device and press SELECT. "X" means the device has been assigned.

**NOTE** The filter pump is always assigned to freeze protection.

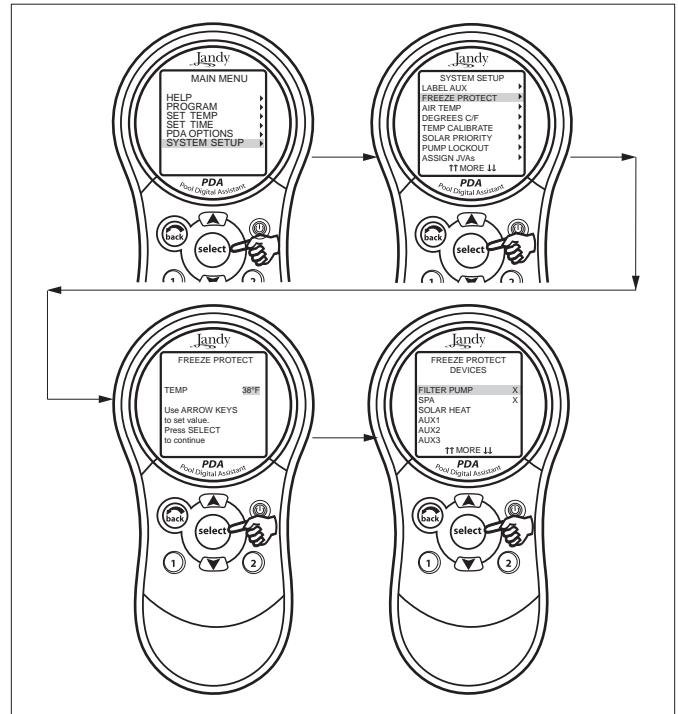

Figure 28. Freeze Protection Menu

### 4.1.6 Assign JVAs Menu

Highlight MENU and press SELECT. Highlight SYSTEM SETUP and press SELECT (see Figure 29). Highlight ASSIGN JVA and press SELECT. Highlight the JVA you wish to assign and press SELECT.

**NOTE** If a solar sensor is installed, the Solar JVA will automatically be assigned and will be marked as USED.

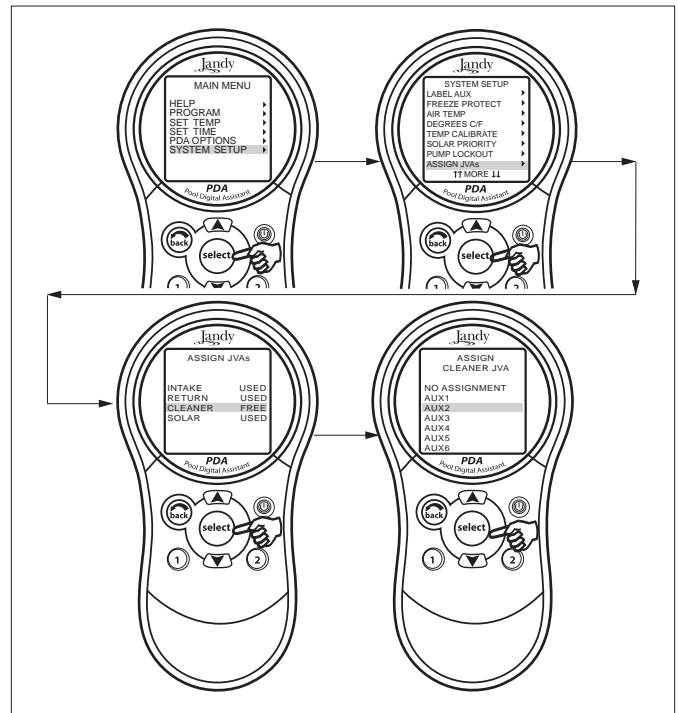

Figure 29. Assign JVA Menu

## 4.2 Restarting the System (Clear Memory) Menu

To remove all labeling, programming, assignments and temperature settings, highlight MENU and press SELECT. Highlight SYSTEM SETUP and press SELECT (see Figure 30). Highlight CLEAR MEMORY and press SELECT. Highlight CONTINUE and press SELECT. Use the UP or DOWN button to highlight YES or NO and press SELECT. There will be about a 15 second delay before you see the FINISHED screen. Highlight CONTINUE and press SELECT to return to the SYSTEM SETUP.

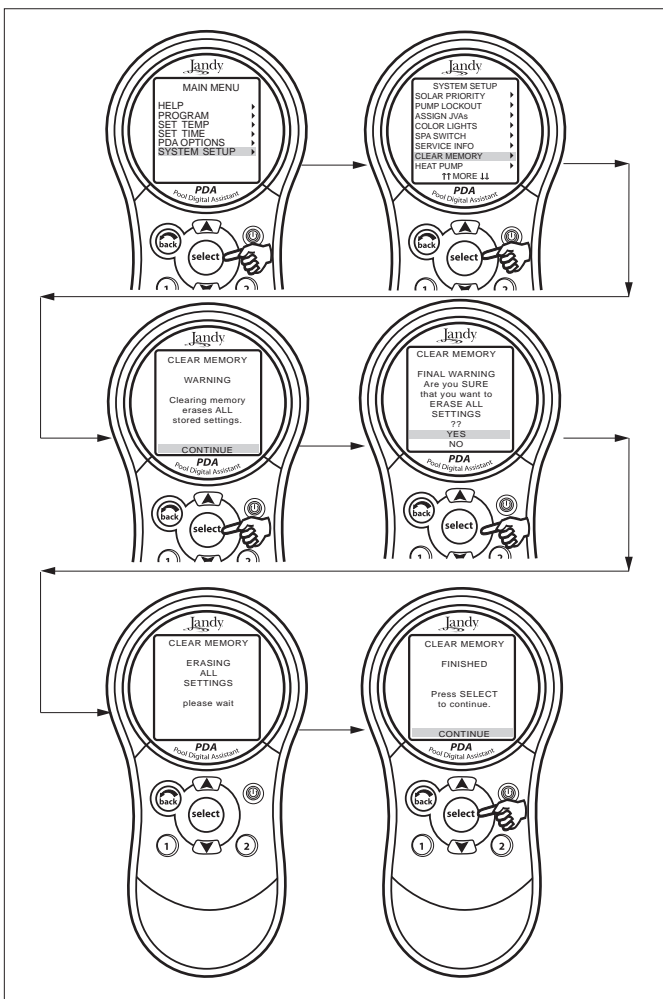

Figure 30. Clear Memory Menu

## 4.3 PDA System Defaults and General Modes

### Default Temperature (Pool/Spa Combination)

Default Pool Temp = 80° F

Default Spa Temp = 102° F

### Default Temperature (Pool/Spa Only)

Default TEMP1 = 80° F

Default TEMP2 = 60° F

### Default Spa Side Switch Settings

Button 1 = Spa (Filter Pump for pool/spa only models)

Button 2 = Spa Heater (Temp1 pool/spa only models)

Button 3 = AUX1

Button 4 = AUX2

### Default Freeze Protection Settings

Filter Pump: Freeze Protection ON.

All Other Equipment: Freeze Protection OFF

Default Activation Temperature: 38° F

**NOTE** If you select SPA to be freeze protected, water circulation will switch between pool and spa every 30 minutes during freezing conditions once freeze mode is active.

### 4.3.1 Power Center Service Switch

#### AUTO Mode (automatic)

1. The PDA Handheld Remote has complete control of all functions.
2. All programmed settings will operate.
3. All safety delays and equipment protection interlocks are operational.

#### SERVICE Mode

1. The power center has complete control of all functions.
2. Service mode must be turned on/off at the power center.
3. No programmed settings will work.

### CAUTION

In service mode, equipment protection safety interlocks are overridden.

#### TIMEOUT Mode

1. The power center has complete control for three (3) hours.
2. After three (3) hours the system will return to AUTO mode.
3. Programmed on/off times will be overridden during the three (3) hours.
4. After the three (3) hour "time out", the system will resume any programmed items that were overridden.

## Battery Backup

A nine-volt battery is located at the power center. The battery keeps the clock running during a power outage so the time and date will be correct when power is restored. Programming will not be lost even if the battery is dead. **Do not** install the battery in the power center until the system is ready to operate. Battery will drain if power is left off. Review **DIAGNOSTICS** in the **SYSTEM SETUP** section of the menu. The **DIAGNOSTICS** will indicate when the battery needs replacement.

### ATTENTION

**Special Note to Startup Person:** The AquaLink RS PDA allows two (2) options for operating the pool equipment on the first day of operation:

*Option #1* - Once all programming of equipment is completed, the AquaLink RS PDA will automatically review all programs and turn on any equipment which is programmed to be on.

*Option #2* - To operate the filter pump or cleaner continually for the first day, leave the power center service button in AUTO mode. Using the PDA Handheld Remote, turn on the filter pump or the equipment you want to run.

**NOTE** If the equipment has already been turned on by a program time, turn the equipment off and then back on.

The equipment that is activated will run continuously, ignoring the first programmed off time, and will turn off at the programmed off time for the next day (only if a program has been entered).

### 4.4 PDA Handheld Remote Menu Flow Chart

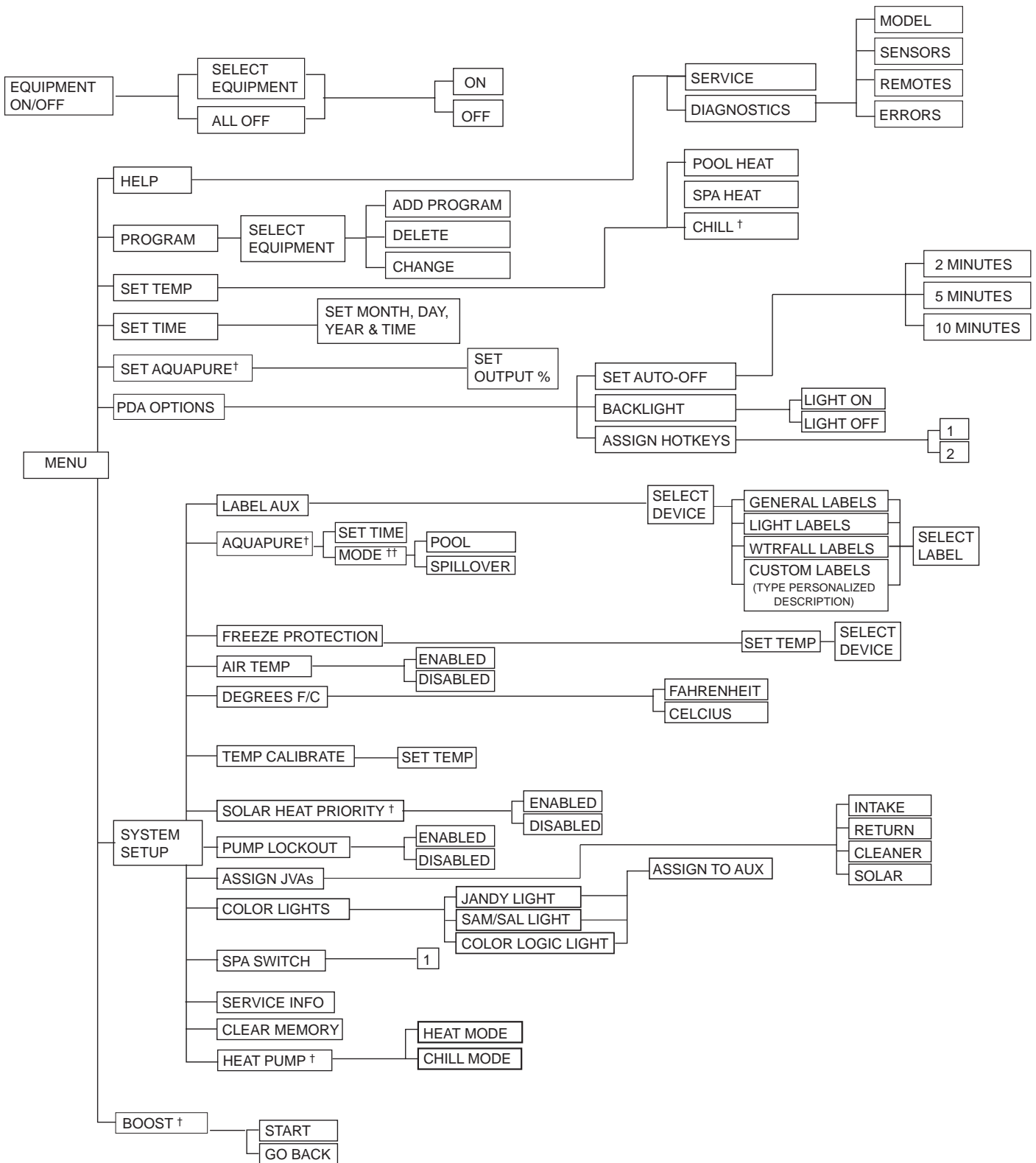

† Items Seen Only With Optional Equipment  
 †† Mode Only Displayed When DIP Switch #3 is Set to ON



## Section 5. Troubleshooting

### 5.1 PDA Quick Troubleshooting Guide

The AquaLink RS PDA will stop communicating anytime interference (such as a 900 MHz device) prevents a valid signal transmission. When communication is lost the PDA Handheld Remote will lock on the startup screen until a good link is again achieved, usually within a few seconds. If communication is not reestablished within a few seconds or this happens often, use the troubleshooting information in the following table for suggestions.

Symptom	Problem	Possible Solution
Power Center override switches operate when in Service or Time Out Mode, but the PDA Handheld Remote is completely dead (no backlight on or display).	Dead batteries in the PDA Handheld Remote.	Replace batteries.
PDA Handheld Remote backlight is on and the startup screen is displayed. The override switches at the power center operate as they should.	PDA is not communicating with the power center PCB.	Check the two center wires (black & yellow) of the four conductor cable to the transceiver J-box. Also check the installation of the PPD on the power center PCB. If the PPD is not seated correctly the system will not communicate.
PDA Handheld Remote backlight is on and the startup screen is displayed, but override switches at the power center do not operate at all.	<ol style="list-style-type: none"> <li>1. Damaged or improperly installed PPD.</li> <li>2. Wrong PPD.</li> <li>3. Damaged power center PCB.</li> </ol>	<ol style="list-style-type: none"> <li>1. Check alignment of the PPD.</li> <li>2. Make sure that the PPD is for a PDA.</li> <li>3. If PPD is installed correctly, replace the power center PCB.</li> </ol>
Some buttons do not operate from the PDA Handheld Remote, nor from the power center override switches.	Wrong PPD chip installed at the power center PCB.	Ensure that the PPD revision number is the correct revision required for the application.
System locked up.	Microprocessor locked.	Turn off power to the system. Disconnect battery at the Power Center and turn on power. Reconnect the battery and reset time and date.
Programs do not run at the correct time.	AquaLink RS does not display correct time and date.	At the PDA Handheld Remote, set correct time and date. In Diagnostics, check battery level. If LOW BATTERY is displayed, replace battery at the Power Center to ensure correct time and date are maintained.

Symptom	Problem	Possible Solution
One button on the Four Function Remote does not operate.	<p>Check programming first. If the Four Function Remote is programmed correctly, the button may be shorted.</p> <p><b>NOTE</b> If dip switch 1 (CLEANER) is on, button # 3 on the Four Function Remote will not operate when in spa mode <i>unless</i> this button is programmed to a circuit other than Aux 1.</p>	Replace the Four Function Remote. Use MENU, REVIEW, SPA SWITCH to check programming.
Pool cleaner booster pump turns on without the filter pump being on, and can run with the spa on.	<p>System is not recognizing DIP switch #1 is on.</p> <p><b>NOTE</b> Before turning on any DIP switches, first turn off all equipment. Do not program any auxiliaries until all DIP switches are set.</p>	Turn off all equipment buttons, then turn off power to the system, finally turn off, then on, DIP switch #1. Turn on power and test system.
System comes on at times that are not programmed.	Phantom programs.	At the PDA press MENU, then select PROGRAM. Make note of all programs (the Four Function Remote setting, labels, and temperature settings) then turn off all DIP switches and go to the PDA. CLEAR MEMORY, reprogram and try system again.
Heater will not fire. Heater LED will not light in "Service Mode".	Water temperature sensor not installed or defective.	Check water temperature sensor.
LCD screen display stays on startup screen.	No communication between PDA Handheld Remote and Power Center J-box.	Change the Frequency Channel. See Section 3.7.3.

# Section 6. Power Center Wiring Diagram

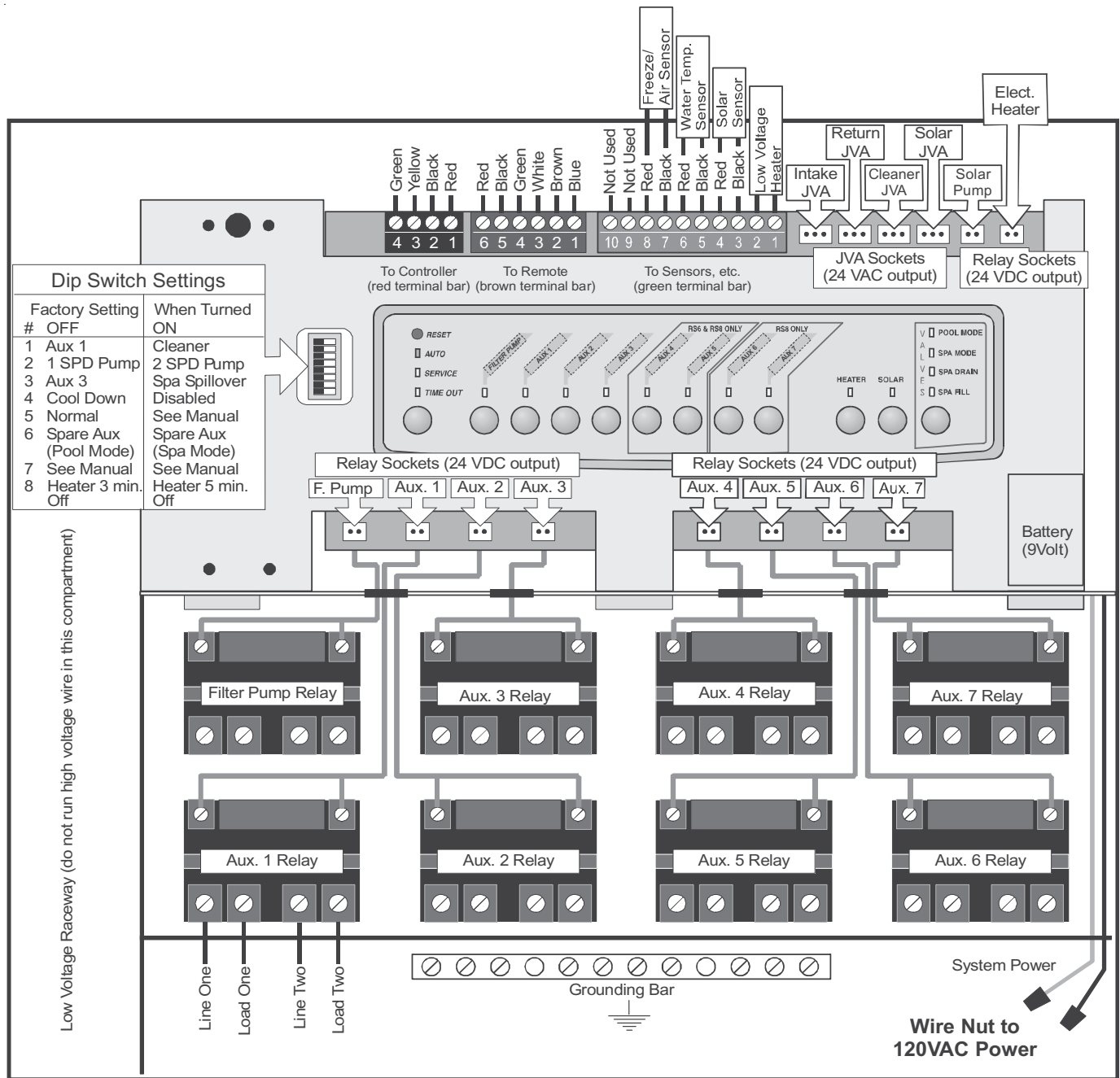

Dip Switch Settings	
Factory Setting # OFF	When Turned ON
1 Aux 1	Cleaner
2 1 SPD Pump	2 SPD Pump
3 Aux 3	Spa Spillover
4 Cool Down	Disabled
5 Normal	See Manual
6 Spare Aux (Pool Mode)	Spare Aux (Spa Mode)
7 See Manual	See Manual
8 Heater 3 min. Off	Heater 5 min. Off

## Section 7. Power Center PCB DIP Switch Settings

**IMPORTANT** Do not program equipment ON/OFF times until all DIP switches are set.

### 7.1 DIP Switch Functions

#### *DIP #1 ON- AUX 1 Controls Pool Cleaner*

If you installed a booster pump for a pool cleaner, the relay coil for the booster pump must be plugged into the AUX 1 relay socket. If a non-booster pump cleaner is installed, plug the JVA into the cleaner JVA socket. Turn ON DIP Switch #1.

- Main filter pump turns on whenever cleaner turns on.
- Cleaner will not turn on until filter pump has been on for three (3) minutes (to ensure priming of system).
- Cleaner turns off when water circulation is to spa.
- Cleaner turns off when spa spillover feature is activated.
- Cleaner turns off for three (3) minutes when solar is activated (to ensure air is purged from the system).
- AquaLink RS PDA Handheld Remote display reads "CLEANER" rather than "AUX 1".

#### *DIP #2 ON- AUX 2 Controls Low Speed of Filter Pump*

Turn this switch ON if you want to control both speeds of a two-speed filter pump. With this switch on, the filter pump button on the AquaLink RS PDA will control high speed and the HOT KEY 2 (default) button will control low speed.

**IMPORTANT** You must also install a Jandy Two-Speed Relay.

#### *DIP #3 ON- AUX 3 Controls Spa Spillover (Operates with Pool/Spa Combination)*

Turn this switch ON, and when the AUX 3 button on the AquaLink RS PDA (or Spa Side Switch) is pressed, the Return Valve Actuator will rotate to spa circulation. Because the Intake Valve Actuator does not rotate, the spa will fill with water and overflow into the pool.

**NOTE** Leave AUX 3 relay socket empty.

#### *DIP #4 ON- Heater Cool Down Disabled*

Turn this switch ON to disable the heater cool down safety feature on the AquaLink RS.

#### **CAUTION**

Turn this DIP Switch ON only if you are using an electric heater or a heat pump that does not retain residual heat. If you are turning this switch ON for service purposes, be sure to turn it back off.

#### *DIP #5 ON- Factory Use Only*

This switch is used for calibration by Jandy certified technicians only. Please leave this switch in the OFF position.

#### *DIP #6 ON - Pool/Spa Combination Systems Only*

Change Spare AUX to activate when Filter Pump is on and system is in spa mode. Spare AUX socket is on the back side of the Power Center PCB.

#### *DIP #7 ON- Not Used*

#### *Dip #8 ON- Heat Pump Instead of Gas Heater*

Turn this switch ON if you have installed a heat pump instead of a gas heater. After thermostat setting has been reached, heater will remain OFF for 5 minutes.

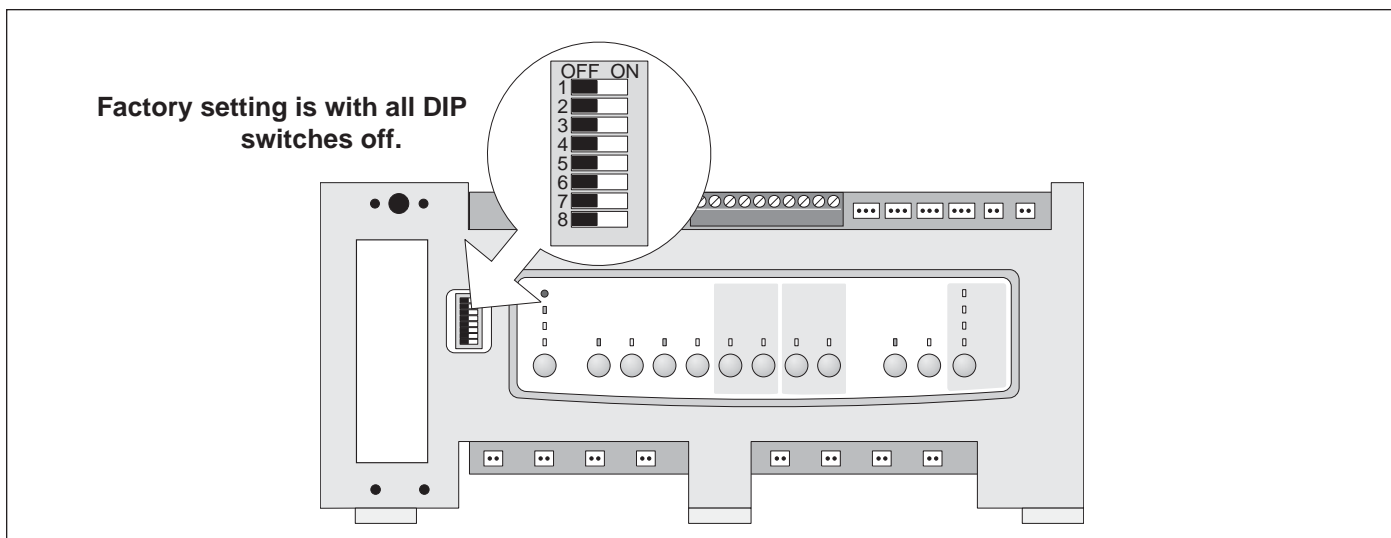

### 7.2 DIP Switch Settings for Pool and Spa Combination

DIP Switch #	OFF	ON
1	AUX1= any equipment	AUX1= Pool Cleaner
2	AUX2= any equipment	AUX2= Low Speed for a two-speed filter pump. Filter pump circuit becomes High Speed.
3	AUX3= any equipment	AUX3= Spa Spillover effect- Combination controls only.
4	Heater cool down operates.	Heater cool down disabled.
5	Normal operation	Factory adjustment- when this switch is on, temperature delays are eliminated. <b>Do not leave this switch in the ON position.</b>
6	Spare Aux activates with Filter Pump when Spa OFF.	Spare Aux activates with Filter pump with Spa on.
7	Spare	No change on Combination or Only Controls.
8	After thermostat setting has been reached, heater will remain OFF for 3 minutes.	After thermostat setting has been reached, heater will remain OFF for 5 minutes.

### 7.3 DIP Switch Settings for Pool or Spa Only

DIP Switch #	OFF	ON
1	AUX1= any equipment	AUX1= Pool Cleaner
2	AUX2= any equipment	AUX2= Low Speed for a two-speed filter pump. Filter pump circuit becomes High Speed.
3	AUX3= any equipment	No change
4	Heater cool down operates.	Heater cool down disabled.
5	Normal operation	Factory adjustment- when this switch is on, temperature delays are eliminated. <b><i>Do not leave this switch in the ON position.</i></b>
6	Spare	No change
7	Spare	No change
8	After thermostat setting has been reached, heater will remain OFF for 3 minutes.	After thermostat setting has been reached, heater will remain OFF for 5 minutes.

## Section 8. General, Water Feature and Light Aux Labels

General Labels	Light Labels	Waterfall Labels
Aerator	#1	Waterfall
Air Blower	#2	Waterfall 1
Backwash	#3	Waterfall 2
Booster Pump	Back	Waterfall 3
Chem Feed	Basement	Sheer Dscnt
Cleaner	Beach	Rockfall
Color Wheel	Bedroom	Laminar Jet
Drain Line	Bug	
Fan	Cabana	
Fiber Optic	Color Wheel	
Fill Line	Deck	
Filter Pump	Dock	
Floor System	Drive	
Fogger	East	
Fountain	Entry	
Heat Pump	Equipment	
Heater	Fan	
Hi-E2	Fence	
High Speed	Flood	
Home A/C	Founth	
Home Heat	Front	
Jet Pump	Garage	
Lite	Garden	
Lamp	Gazebo	
Low Speed	Hall	
Mist	House	
Music	Kitchen	
Not Used (see note)	Laminar Plsr	
Ozonator	Left	
Pond	North	
Ray-Vac	Path	
Slide	Patio	
Solar Pump	Perimeter	
Spa	Pond	
Spillway	Pool	
Sprinkler 1	Porch	
Sprinkler 2	Right	
Sprinkler 3	Room	
Stereo	Sauna	
Stream	Security	
Swim Jet	Shower	
Timed Aux	Shrub	
Valve(s)	South	
Wtr Feature	Spa	
Whirlpool	Statue	
	Steps	
	Table	
	Tier	
	Tree	
	Walk	
	Water Ftr	
	Wtrfll	
	West	
	Yard	

**NOTE** Please be aware that if the label NOT USED from the GENERAL LABEL menu is used on an AUX relay, the relay will not engage.

## LIMITED WARRANTY

Thank you for purchasing Jandy® pool and spa products. Jandy Pool Products, Inc. warrants all parts to be free from manufacturing defects in materials and workmanship for a period of one year from the date of retail purchase, with the following exceptions:

- AquaLink® RS units installed with Jandy® Surge Protection Kits will be covered for two years.
- NeverLube® valves are warranted for the life of pool and/or spa on which they were originally installed.
- AquaPure™ Electronic Chlorine Generator Electrolytic Cells carry a 5 year limited warranty on a prorated basis.

This warranty is limited to the first retail purchaser, is not transferable, and does not apply to products that have been moved from their original installation sites. The liability of Jandy Pool Products, Inc. shall not exceed the repair or replacement of defective parts and does not include any costs for labor to remove and reinstall the defective part, transportation to or from the factory, and any other materials required to make the repair. This warranty does not cover failures or malfunctions resulting from the following:

1. Failure to properly install, operate or maintain the product(s) in accordance with our published Installation, Operation and Maintenance Manuals provided with the product(s).
2. The workmanship of any installer of the product(s).
3. Not maintaining a proper chemical balance in your pool and/or spa [pH level between 7.2 and 7.8, Total Alkalinity (TA) between 80 to 120 ppm, Total Dissolved Solids (TDS) less than 2000 not including salt ppm].
4. Abuse, alteration, accident, fire, flood, lightning, rodents, insects, negligence or acts of God.
5. Scaling, freezing, or other conditions causing inadequate water circulation.
6. Operating the product(s) at water flow rates outside the published minimum and maximum specifications.
7. Use of non-factory authorized parts or accessories in conjunction with the product(s).
8. Chemical contamination of combustion air or improper use of sanitizing chemicals, such as introducing sanitizing chemicals upstream of the heater and cleaner hose or through the skimmer.
9. Overheating; incorrect wire runs; improper electrical supply; collateral damage caused by failure of O-Rings, DE grids, or cartridge elements; or damage caused by running the pump with insufficient quantities of water.

### LIMITATION OF LIABILITY:

This is the only warranty given by Jandy Pool Products, Inc. No one is authorized to make any other warranties on behalf of Jandy Pool Products, Inc. **THIS WARRANTY IS IN LIEU OF ALL OTHER WARRANTIES, EXPRESSED OR IMPLIED, INCLUDING BUT NOT LIMITED TO ANY IMPLIED WARRANTIES OF FITNESS FOR A PARTICULAR PURPOSE AND MERCHANTABILITY. JANDY POOL PRODUCTS, INC. EXPRESSLY DISCLAIMS AND EXCLUDES ANY LIABILITY FOR CONSEQUENTIAL, INCIDENTAL, INDIRECT OR PUNITIVE DAMAGES FOR BREACH OF ANY EXPRESSED OR IMPLIED WARRANTY.** This warranty gives you specific legal rights. You may also have other rights which vary by state or province.

### WARRANTY CLAIMS:

For prompt warranty consideration, contact your dealer and provide the following information: proof of purchase, model number, serial number and date of installation. The installer will contact the factory for instructions regarding the claim and to determine the location of the nearest designated service center. If the dealer is not available, you can locate a service center in your area by visiting [www.jandy.com](http://www.jandy.com) or by calling our technical support department at (707) 776-8200 extension 260. All returned parts must have a Returned Material Authorization number to be evaluated under the terms of this warranty.



ETL LISTED  
CONFORMS TO  
UL STD 1563

CERTIFIED TO  
CAN/CSA C22.2 NO. 218.1

PDA HANDHELD REMOTE  
FCC ID: S8F826X

PDA TRANSCEIVER  
FCC ID: S8F8252

H0572200B

Jandy Pool Products, Inc.  
6000 Condor Drive • Moorpark, CA USA 93021 • 707.776.8200 • Fax 707.763.7785  
Litho in U.S.A. © Jandy Pool Products, Inc. 0610



## Free Manuals Download Website

<http://myh66.com>

<http://usermanuals.us>

<http://www.somanuals.com>

<http://www.4manuals.cc>

<http://www.manual-lib.com>

<http://www.404manual.com>

<http://www.luxmanual.com>

<http://aubethermostatmanual.com>

Golf course search by state

<http://golfingnear.com>

Email search by domain

<http://emailbydomain.com>

Auto manuals search

<http://auto.somanuals.com>

TV manuals search

<http://tv.somanuals.com>