

LIMITED WARRANTY

Compool Corporation warrants to the purchaser of this control system, for the period of one year from the date of original purchase for use, that any defective product proved to be caused by faulty workmanship or faulty material, will be repaired or replaced at Compool's option for no charge, providing the product is returned to Compool with all transportation charges prepaid.

First Ninety Days: During the first ninety days after installation, if any Compool control shall be found to be defective due solely to faulty material and workmanship, Compool Corporation will additionally cover the reasonable replacement cost charged by an authorized service company.

After Ninety Days: Between the ninety-first day and the end of the first year after installation, no allowances will be made for labor for the removal or reinstallation of any so-claimed defective products.

This warranty covers the **Time Master Controller, LX-10 Service Center, VOR-24 Valve Operators**, and optional **Remote Controls**, including all components and parts. It does not include Valves or Sensors. It extends to the first retail purchaser and any subsequent owners of the system.

This limited warranty applies only to controls which have been installed and maintained in strict accordance with installation and operating instructions provided by Compool Corporation, using installation hardware supplied and/or recommended in writing by Compool, and to controls which have been connected to the correct supply voltage. This limited warranty does not apply to any controls which have been repaired or altered by anyone other than Compool or a person authorized by it; or which have been subject to misuse, neglect or accident; or which have been damaged by wind, freezing or other cause, thing, person or act of God; or which have been subject to damage in transit, during installation, or by someone other than Compool Corporation; or which have been damaged because of a defect in a component or part which is not part of the Compool Control System; or upon which the serial number has been altered, effaced or removed.

This warranty gives you specific legal rights and you may also have other rights which vary from state to state. Compool Corporation does not authorize any person to create any other obligation or liability in connection with Compool controls. Compool Corporation makes no warranty of merchantability or fitness for any use. Any implied warranty applicable to Compool controls is limited in duration to the duration of this written warranty.

Compool Corporation shall not be liable for consequential or incidental damages resulting from breach of this written warranty or any implied warranty. Some states do not allow the exclusion or limitation of incidental or consequential damages, so the above limitation of incidental or consequential damages may not apply to you.

To exercise this warranty, send defective unit, with copy of dated receipt, postage prepaid, to:

COMPOOL CORPORATION
599 Fairchild Drive, Mountain View, California 94043-2217



599 Fairchild Drive
Mountain View
California 94043-2217
(415) 964-2201

INSTALLATION INSTRUCTIONS

TIME MASTER POOL-SPA CONTROL SYSTEM

IMPORTANT SAFETY PRECAUTIONS:

All wiring must be performed by a qualified electrician.

Basic safety precautions and local codes should be observed when installing and using this electrical equipment.

READ AND FOLLOW ALL INSTRUCTIONS.

EQUIPMENT LOCATION:

All electrical equipment must be located five feet or more from pool or spa with the exception of the optional Spa-side Remote Control

1. **LX-10 Service Center** at the equipment pad area.
2. **Time Master** inside house or other weather-protected area.
3. **VOR-24 Valve Operators** at three-port valves.
4. **WTS-5L Water Sensor** at filter pump.
5. **SS-100 Spa-side Remote Control** (optional) at spa site.

LOW VOLTAGE CABLES:

Determine lengths of 22AWG low voltage cable needed between equipment

1. 6pair cable from Time Master to LX-10 Service Center.
2. 2 conductor cable from gas heater to LX-10 Service Center.
3. Water Sensor is provided with 10 feet of 2 conductor cable.
4. Valve Operators are provided with 15 feet of 3 conductor cable.
5. Spa-side Remote Control is provided with 100 feet of 4 conductor cable. Remote Control is also available with 50, 150 or 200 feet of cable.

Install cable. Place cable in plastic or metallic conduit where it runs underground, through concrete, etc.

NOTE: Never install low voltage cable and high voltage wires in the same conduit. A minimum distance of 12" must be maintained between parallel runs of low voltage cable and AC current-carrying wires.

22AWG cable is available from Compool Corporation.

PLUMBING:

Follow recommended schematic (see next page) for location of three-port valves. 2" dia. plumbing is advised to ensure optimum filter pump efficiency.

1. A 1/2" spa makeup line, (incorporating a 1/2" manual gate or ball valve and, for elevated spas, a 1/2" check valve) should be provided around the return valve (see schematic). This enables clean water to be circulated to the spa while the system is in POOL mode.
2. Spa should be at or above the level of the pool. If spa is attached to pool, provide a dam between the two bodies of water to allow spa overflow into pool. If spa is not attached to pool, an overflow, sufficient in size to carry full pump-flow, must be installed at water level in the spa.

HYDRAULIC AND ELECTRICAL SCHEMATIC

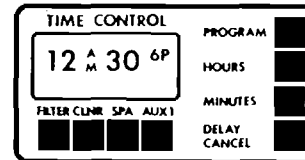
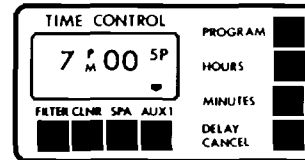
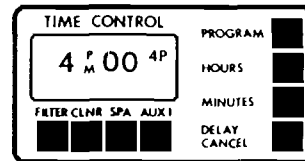
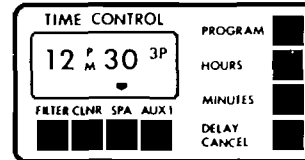
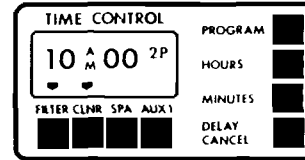
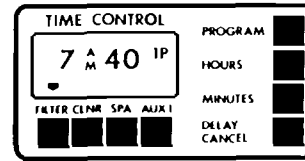
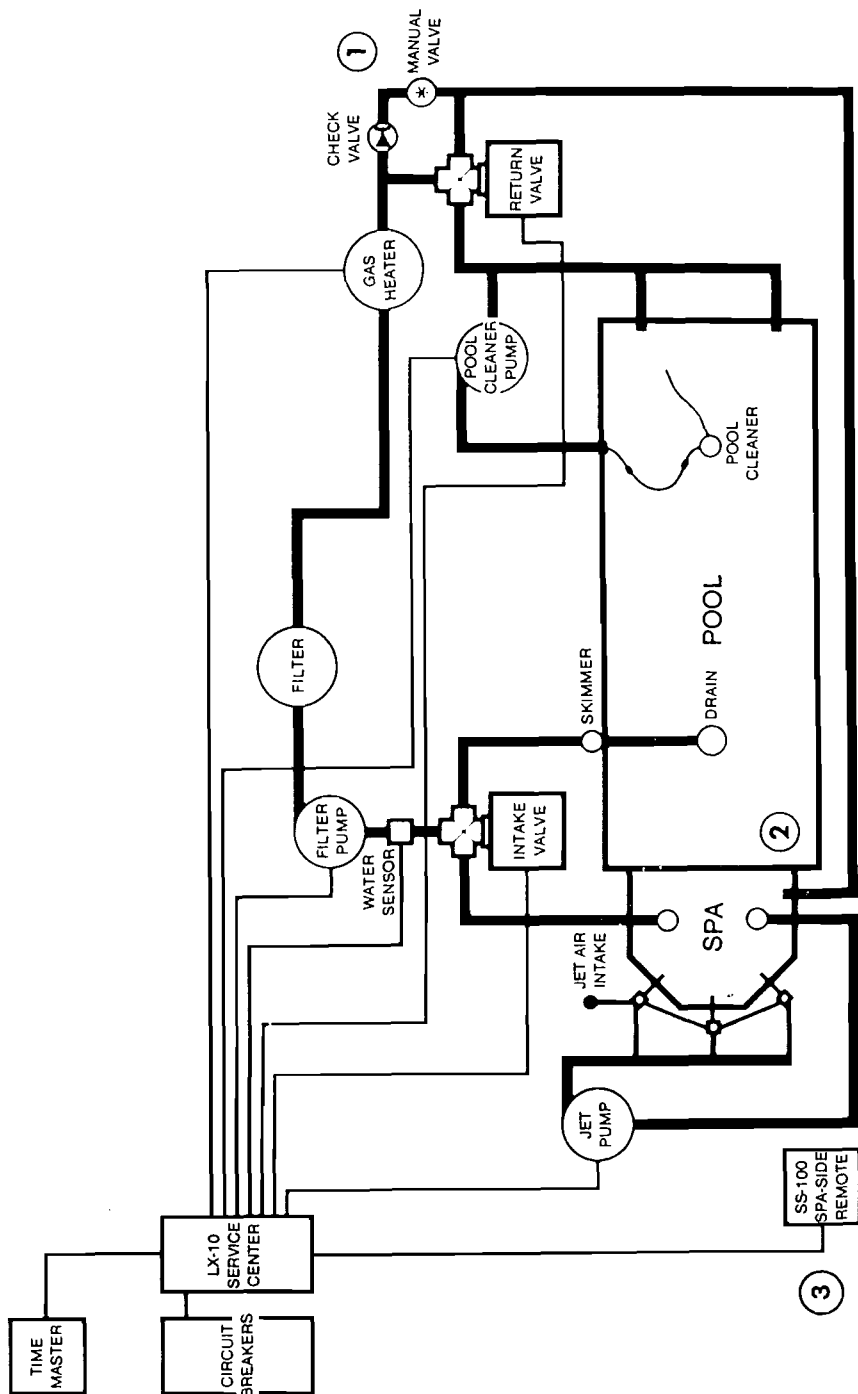

SAMPLE PROGRAM:

In the adjacent examples:

- 1P: The first program will turn on the filter at 7:40 am.
- 2P: At 10:00 am, the filter pump will continue to run, and the pool cleaner will turn on.
- 3P: The pool cleaner will turn off at 12:30 pm, and valves will rotate so that filter pump circulates water through the spa.
- 4P: At 4:00 pm, valves will rotate back to pool circulation, and filter pump will turn off (after 4 minute delay).
- 5P: The fifth program will turn on AUX 1 (pool light) at 7:00 pm.
- 6P: AUX 1 (pool light) will be turned off at 12:30 am.

UNUSED PROGRAMS:

If your personal program does not use all six programs, unused programs must be turned off:

1. Push PROGRAM button until unused program is displayed.
2. Push and hold down MINUTES and HOURS buttons simultaneously.
3. First release HOURS, and then MINUTES button. "OFF" will now be displayed along with flashing program number.
4. To eliminate "OFF", push HOURS button once.

NOTE: Equipment can be manually turned ON or OFF by pushing appropriate buttons while clock is in "time mode".

LOW VOLTAGE WIRING DIAGRAM

OPERATING INSTRUCTIONS

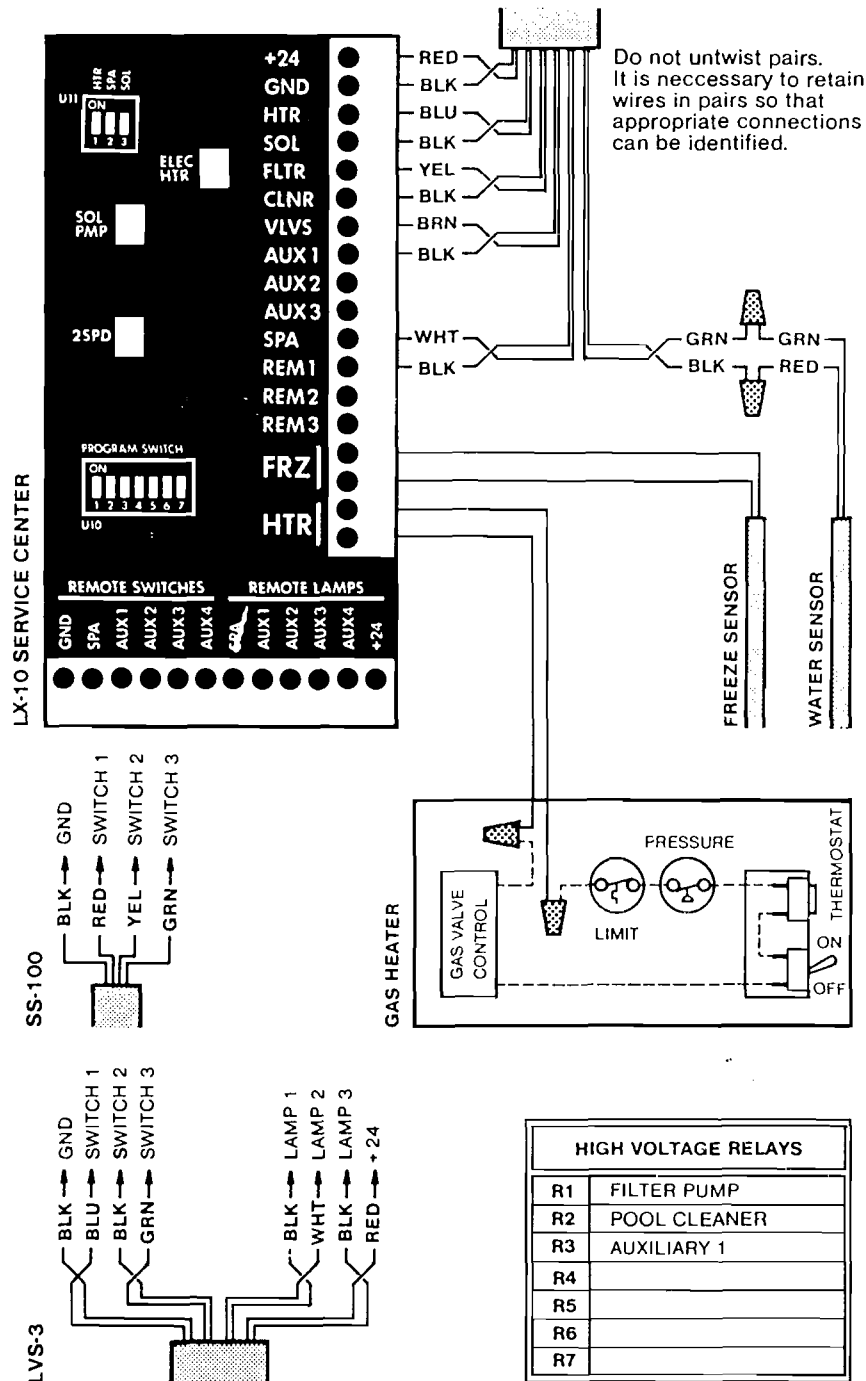

GENERAL CONTROL FEATURES

FILTER PUMP OFF DELAY. This causes the filter pump to run an additional 4 minutes every time it is turned off. The purpose of this is to protect the gas heater and plumbing from possible scale build-up and thermal stress. These occur when residual heat in the gas heater is not allowed to dissipate after heater is turned off.

POOL CLEANER ON DELAY. Every time the pool cleaner pump is turned on, this circuit prevents it from running until 4 minutes have passed. This protects the pump from damage caused by air in the water lines that may have entered into the plumbing since it was last used.

TIME CONTROL

EQUIPMENT BUTTON FUNCTIONS:

- FILTER:** Turns filter pump ON and circulates POOL water.
- CLNR:** Turns filter and cleaner pumps ON. (Cleaner delayed 4 minutes)
- SPA:** Turns filter pump ON and circulates SPA water. Allows heater to operate. Overrides CLNR key and turns pool cleaner pump OFF, even if CLNR "flag" is present.
- AUX1:** Turns electrically controlled function ON. (lights, jets, etc.)

TEMPERATURE CONTROL

WATER TEMPERATURE Display:

Pool temperature is displayed when the pool is operating, spa temperature when the spa is operating. If filter pump is off, display may be meaningless.

THERMOSTAT:

Desired pool or spa temperature is set here.

HEATER CONTROL

SWITCH POSITIONS:

- POOL:** Allows heating of pool to the preset temperature level.
- SPA:** Allows heating of spa to the preset temperature level.
- OFF:** Allows no heating.

HEATER ON Light:

When lit, indicates that heater is on.

STATUS DISPLAY

The presence of a light next to an equipment label indicates that it is ON. The absence of a light indicates OFF.

DELAY CANCEL BUTTON FUNCTIONS:

- FILTER:** To override the Filter Delay Circuit, press **CANCEL OFF DELAY** button. Provided that there is no "flag" present at either **FILTER**, **CLNR** or **SPA** buttons, the filter pump will shut off immediately.
- CLNR:** To override the Cleaner Delay Circuit, press **CANCEL ON DELAY** button. Provided that there is a "flag" present at the **CLNR** button, the pool cleaner pump will start immediately. If **SPA** is on, **CLNR** is inoperative.

SETTING THE CLOCK

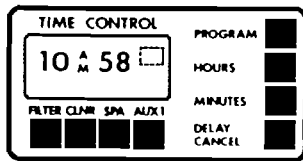

1. Push **PROGRAM** button until no flashing number appears on the right of the display. The clock is now in "time mode".
2. Push **HOURS** and **MINUTES** buttons until correct time of day is displayed. **NOTE:** Pay attention to the AM/PM indicator.

PROGRAMMING

There are six possible programs during a 24 hour period for turning the pool equipment ON or OFF. More than one piece of equipment may be programmed ON or OFF at the same time.

1. Push **PROGRAM** button once. A 1P (1st Program) will flash on the right of the display. The clock is now in "program mode".
2. Enter desired program time by pushing the **HOURS** and **MINUTES** buttons. In "program mode", minutes are advanced in ten minute increments. Pay attention to the AM/PM indicator.
3. Push **FILTER**, **CLNR**, **SPA**, or **AUX1** button to program equipment ON or OFF. The presence of a "flag" above each button indicates that the equipment is programmed ON. The absence of a "flag" indicates OFF.
4. Repeat the preceding sequence for the remaining five programs (2P-6P).
NOTE: Each time change requires a new program.
5. After programming, push **PROGRAM** button to return clock to "time mode". If this is forgotten, after four minutes the clock will automatically return to "time mode".

3. If the spa is constructed in concrete and optional Spa-side Remote Control (model SS-100) is to be used, select a convenient location in the deck or above water level in the spa wall. **SS-100 should not be submerged by the spa water.** Install a 6" to 12" length of 1/2" pvc pipe at this location to provide a receptacle for SS-100. This pipe should be level and protrude beyond the finished surface of spa. It can be cut back at a later date. Connect 1/2" coupling and reducing bushing for either 1/2" or 3/4" conduit, and provide conduit as necessary to location of LX-10 Service Center.
Do not install Outdoor Remote Control until spa construction is completed.

LX-10 SERVICE CENTER:

Select a convenient location (at the equipment pad area) to mount LX-10 Service Center. Ensure that the location is greater than 5 feet from the water's edge and no further than 15 feet from the three-port valves. Mount the LX-10 on a flat surface, using appropriate screws through the three external mounting points located on the side of the enclosure. **Do not drill and mount from inside the enclosure.** Install to provide drainage of compartment for electrical components.

All low voltage connections are made to printed circuit board, located behind hinged faceplate in left side compartment.

Strip jacket of 6pair cable 6" to identify the twisted pairs and assure correct connections. Strip insulation of each wire 1/4", and connect to screw terminal in accordance with wiring diagram located on inside of enclosure cover.

NOTE: For the convenience of the serviceman, the screw terminal can be unplugged from printed circuit board without disconnecting wires.

VALVE OPERATORS:

Mount Valve Operators (model VOR-24) to three-port valves in accordance with instructions printed on box.

Plug cables into side of each Valve Operator, and run cables to low voltage compartment of LX-10 Service Center. Plug other end of cables into appropriate valve socket on printed circuit board: intake (suction) valve to **INT valve socket**, and return valve to **RET valve socket**.

WATER SENSOR:

Select a convenient location to mount Water Sensor (model WTS-5L) in the plumbing system at the filter pump. Ensure that this location is no greater than 10 feet from LX-10 Service Center, otherwise cable will need to be extended. Disconnect Water Sensor from **WTS-** and **WTS+** terminals on printed circuit board of Time Master. Remove clamp kit from behind service panel in right side compartment of LX-10, and install Sensor in accordance with instructions.

Caution: Overtightening of clamp can cause deformation of O-ring seal.

Run cable from Sensor location to low voltage compartment of LX-10. Cut off excess cable if necessary. Strip insulation 1/4" and connect to black-green pair of 6pair cable in accordance with wiring diagram located inside LX-10 cover. Pay special attention to polarity of Sensor as indicated by color-coding.

GAS HEATER:

Inside the heater, interrupt wire between thermostat and gas valve, and connect 2 conductor cable with wire nuts, in accordance with wiring diagram which is located inside LX-10 cover. **Do not disconnect high limit and pressure switches.**

Run cable to LX-10 low voltage compartment. Strip insulation 1/4", and connect to **HTR terminals** on printed circuit board.

AUXILIARY EQUIPMENT CONTROL (OPTIONAL):

The standard Time Master system is provided with 3 power relays for controlling filter pump, pool cleaner, and auxiliary 1 (pool light).

It is possible to control additional equipment (such as a jet pump, air blower, spa light, etc.) by installing extra relay kits (model RLY-LX). The LX-10 Service Center will accommodate a total of 7 relays. **Note: Further relays may be controlled by an additional Power Center (model LX-36).**

Install RLY-LX Relay Kit at the LX-10 in accordance with instructions provided.

SPA-SIDE REMOTE CONTROL (OPTIONAL):

When the spa construction is completed, install optional Spa-side Remote Control (model SS-100) in accordance with instructions provided:

1. Cut back the 1½" dia. pvc receptacle flush with spa wall finish or surface of deck.
2. Making sure that screw threads are facing out, glue adapter into receptacle using pvc cement.
3. Thread cable through gasket, and run through conduit to LX-10 low voltage compartment.
4. Before installing SS-100, rotate 7 turns counterclockwise to avoid undue twisting of cable.
5. Screw SS-100 into adapter and finger-tighten. Caution: Do not use wrench.
6. At the LX-10, cut off excess cable if necessary. Strip insulation ¼", and make connections to **REMOTE SWITCHES** screw terminals in accordance with wiring diagram located inside enclosure cover.

Connect black wire (switch common) to **GND** terminal, and connect red, yellow, and green wires to desired terminal for **SPA, AUX 1, AUX 2, AUX 3** and **AUX 4**.

Note: for the convenience of the serviceman, the screw terminal can be unplugged from printed circuit board without disconnecting wires.

INDOOR REMOTE CONTROL (OPTIONAL):

Select a convenient location inside the house or other weather-protected area to mount the LVS-3(3 button indoor remote) or LVS-3TR(3 button indoor remote w/ digital temperature display).

Install in accordance with instructions provided. At the LX-10 low voltage compartment, strip jacket of cable 6" to identify the twisted pairs and assure correct connections. Strip insulation of each wire ¼", and connect to appropriate screw terminals at **REMOTE SWITCHES** and **REMOTE LAMPS** terminal:

1. Select any three circuits from **SPA, AUX 1, AUX 2, AUX 3,** and **AUX 4**.
2. Number the circuits 1, 2, and 3.
3. Make sure that the corresponding **SW** and **LMP** wires from the Indoor Remote are connected to the appropriate circuit at the LX-10 **REMOTE SWITCHES** and **REMOTE LAMPS** terminal.

NOTE: If the LVS-3TR is being used, install the second Water Sensor (included) in accordance with previous instructions, and run cable to LX-10 low voltage compartment. Wire nut to yellow-black pair of wires from LVS-3TR cable (red connects to yellow, green connects to black), in accordance with wiring diagram located inside LVS-3TR.

A **Label Set** for indoor remote controls (model LBL-100) is available from Compool Corporation. This set of 100 different labels provides custom equipment identification at each remote control button.

SYSTEM START-UP

Apply power to the system.

At the Time Master, pull out battery shield to activate back-up battery, and push **HOURS** button until digital readout is displayed.

At the LX-10 Service center, turn **SYSTEM CONTROL** Switch to "SERVICE" position and **FLOW CONTROL** Switch to "POOL" position.

Check that Valve Operators have rotated to correct positions. To adjust position of any valve, simply reverse the cable plug on the side of Valve Operator.

At the LX-10 Service Center, turn **MANUAL CONTROL** Switches to "ON" positions and check that all equipment is operating.

Turn **OUTDOOR REMOTES** Switch to "ON" position and check that optional Spa-side Remote Control is functioning correctly.

Turn **MANUAL CONTROL** Switches to "OFF" positions.

The system is now ready to be operated as desired.

SYSTEM OPTIONS

TWO SPEED PUMP CONTROL:

If the system is equipped with a two speed filter pump, a Dual Speed Relay Kit (model RLY-LXD) should be added at the LX-10 in accordance with installation instructions provided.

The system will automatically run the filter pump in high speed under any of the following conditions:

1. Whenever the heater is on.
2. Whenever pool cleaner is running.
3. Whenever spa is running.

It is possible to eliminate one or more of these conditions by adjusting **U11 Program Switch**, which is located at the top of the printed circuit board. See RLY-LXD installation instructions for details.

PROGRAMMABLE TWO SPEED PUMP CONTROL:

If the system is equipped with a two speed filter pump, it is additionally possible to program the pump to run in high speed by using **AUX 1 Program Button** on the Time Master Controller. However, this feature will only operate when the filter pump is running. Install RLY-LXD as above.

Adjust **U10 Program Switch** (located at the bottom of the printed circuit board) so that Switches #1, #3 and #6 are programmed ON, and Switches #2, #4, #5, and #7 are programmed OFF.

ADDITIONAL VALVE CONTROL:

It is possible to add valve operators (model VOR-24) to the system to actuate additional three-port valves for pool cleaning or for a custom hydraulic feature (such as a fountain, waterfall, second spa, etc.). A total of three valve operators may be added. Install Valve Module (model MOD-VLV1) at LX-10 low voltage compartment in accordance with instructions provided, and connect valve operators accordingly.

ADDITIONAL REMOTE CONTROL IN LIEU OF CLEANER:

If the system does not utilize a separate pool cleaner pump, it is possible to use the pool cleaner relay to activate an additional remote circuit. This circuit is controlled by the Spa-side Remote Control.

NOTE: CLNR Program Button on the Time Master Controller will be redundant. Flag and Status Light may still be turned ON, but display is meaningless.

Adjust **U10 Program Switch** (located at the bottom of the printed circuit board) so that Switches #4, #5 and #6 are programmed ON, and Switches #1, #2, #3 and #7 are programmed OFF.

Modify low voltage wiring as follows:

Disconnect black wire of blk/yel pair from **CLNR screw terminal** on LX-10 printed circuit board, and substitute with yellow wire from SS-100 Spa-side Remote.

SPA WATERFALL CONTROL:

For systems where spa water level is higher than that of the pool, a Spa Waterfall Control (model RLY-WTRFL) may be added.

AUX1 Button at the Time Master or an optional Remote Control switch can be used to rotate the return valve operator to SPA position while system is in POOL mode, thus creating an overflow (waterfall effect) from spa to pool. This effect will cease whenever the system is in SPA mode.

Install RLY-WTRFL in accordance with instructions provided.

ELECTRIC HEATER CONTROL:

For systems which utilize a heat pump or electric heater in lieu of a gas heater, a Relay Kit (model RLY-LX) should be added at the LX-10. Install RLY-LX in accordance with instructions provided, and plug into **ELEC HTR relay socket** on printed circuit board. The power relay is capable of controlling a heat pump, an electric heater rated up to 3KVA, or the magnetic contactor of a larger electric heater.

FREEZE SENSOR:

A Recirculating Freeze Sensor (model FPS-C) may be added to the system. It protects the plumbing and equipment from possible freeze damage by running the filter pump whenever the temperature falls to approx. 41°F. Install FPS-C in accordance with instructions provided.

An Auxiliary Pump Freeze Sensor (model FPS-AUX) may also be added to the system to activate auxiliary equipment (such as jet pump) during potential freezing conditions. Install FPS-AUX in accordance with instructions provided.

CUSTOM OPTIONS:

Additional custom options are also available. These options, however, require custom adjustments at the factory.

Consult Compool Corporation for details.

SAVE THESE INSTRUCTIONS

HIGH VOLTAGE WIRING:

All high voltage connections are made to terminal blocks, which are located behind service panel in right side compartment of LX-10 Service Center.

A high voltage wiring label is located adjacent to terminal blocks.

Knock out holes are provided on bottom of enclosure for conduit mounting.

Provide a separate circuit breaker (if possible) to power the system. Either 115VAC or 230VAC can be used. System draws less than 1 amp. Run wires from circuit breaker to high voltage compartment of LX-10, and connect to top terminal block which is marked "**SYSTEM POWER**". Install 2 jumpers for 115V, or 1 jumper for 230V wiring, according to wiring label.

Provide independent circuit breakers (if possible) for FLTR, CLNR, and AUX 1.

Note: AUX 2, AUX 3, and AUX 4 are optional and require additional relay kits (model RLY-LX).

Run wires from breakers to high voltage compartment of LX-10, and connect to LINE 1 and LINE 2 of relevant terminal blocks.

Connect pumps and other high voltage equipment to LOAD 1 and LOAD 2 terminals at relevant terminal blocks. Each individual terminal block can be wired for either 115 or 230V AC. A relay allocation chart is provided inside enclosure cover for the serviceman's convenience.

To reduce the risk of electric shock, provide a continuous green insulated copper wire, no smaller than #12 AWG, between grounding bus of LX-10 and grounding terminal of electrical supply panel.

A wire connector is provided for bonding to local ground points. To further reduce the risk of electric shock, this connector should be bonded with a #8 AWG copper wire to any metal ladders, water pipes, or other metal within 5 feet of pool or spa.

TIME MASTER:

Select a convenient location inside the house or other weather-protected area to mount Time Master Controller.

Unscrew faceplate from enclosure, and use enclosure as a template to mark and cut hole (8½" wide by 4½" high) in sheetrock or wall paneling. Using the mounting clips

provided, install enclosure into wall.

Strip jacket of 6pair cable 6" to identify the twisted pairs and assure correct connections.

Strip insulation of each wire ¼" and connect to screw terminal in accordance with wiring diagram located inside enclosure.

Caution: Do not untwist pairs. It is necessary to retain wires in pairs so that appropriate connections can be identified.

Note: For the convenience of the serviceman, screw terminal can be unplugged from printed circuit board without disconnecting wires. Mount faceplate to enclosure.

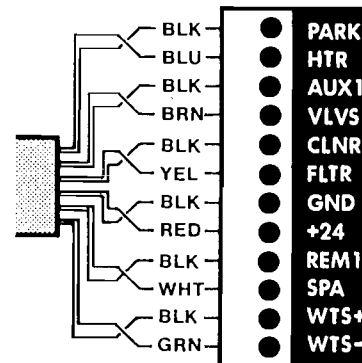

Free Manuals Download Website

<http://myh66.com>

<http://usermanuals.us>

<http://www.somanuals.com>

<http://www.4manuals.cc>

<http://www.manual-lib.com>

<http://www.404manual.com>

<http://www.luxmanual.com>

<http://aubethermostatmanual.com>

Golf course search by state

<http://golfingnear.com>

Email search by domain

<http://emailbydomain.com>

Auto manuals search

<http://auto.somanuals.com>

TV manuals search

<http://tv.somanuals.com>