

**ASAHI
PENTAX**

K2

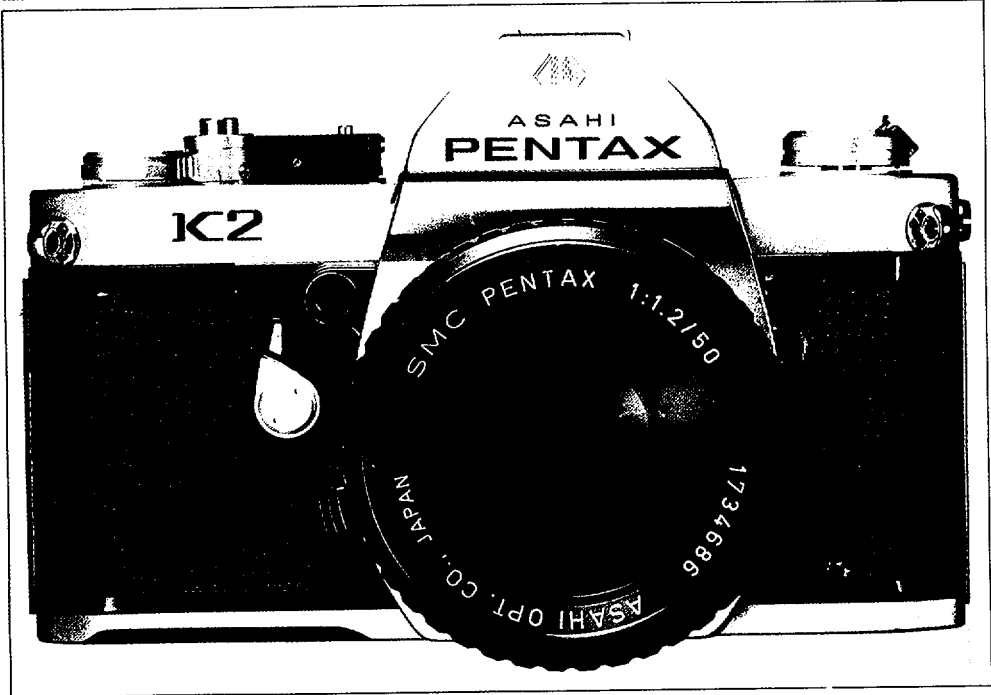

INDEX

Nomenclature	1
Specifications	4
●	
Lens mounting	6
Battery	7
Basic operating instructions	8
Film loading and winding	10
Setting ASA film speed	11
Exposure factor control dial	12
Diaphragm setting	13
Automatic shutter and light metering	14
Manual shutter and light metering	16
●	
Compose and focus	17
Camera holding	18
Film unloading	19
Depth-of-field preview button and guide	21
Depth-of-field table: SMC PENTAX 50mm lens	21
Mirror lock-up	22
Self-timer	23
Flash synchronization	24
Infra-red photography	26
Multiple exposure	27
Using conventional screw-mount TAKUMAR lenses	28
How to use Mount Adaptor K	29
Open-aperture or stop-down metering	30
Resistance to temperature extremes and changes	31
Camera maintenance	32
●	
Warranty policy	34
Memo	36

SMC Pentax lenses and Pentax accessories are engineered and produced meticulously to precise Asahi Pentax specifications. Lenses and accessories from other manufacturers are not produced to these precise specifications and, therefore, may cause difficulties with — or actual damage to — a Pentax camera. Asahi Pentax cannot assume any responsibility or liability for difficulties resulting from the use of any other brand of lenses or accessories with an Asahi Pentax camera.

NOMENCLATURE

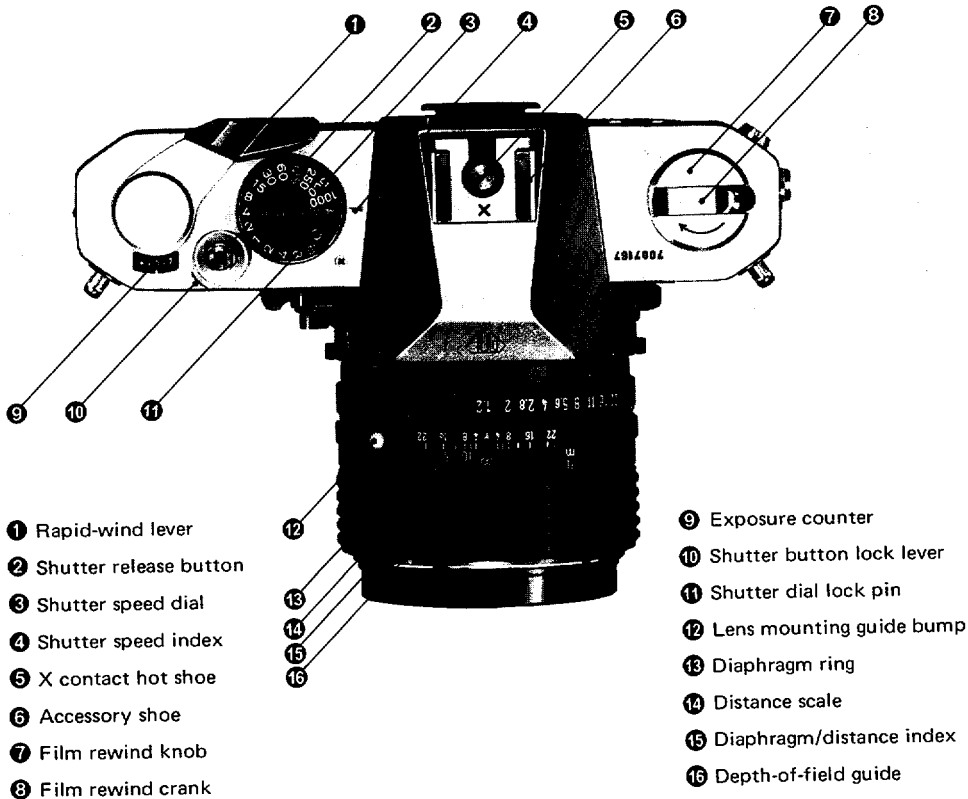

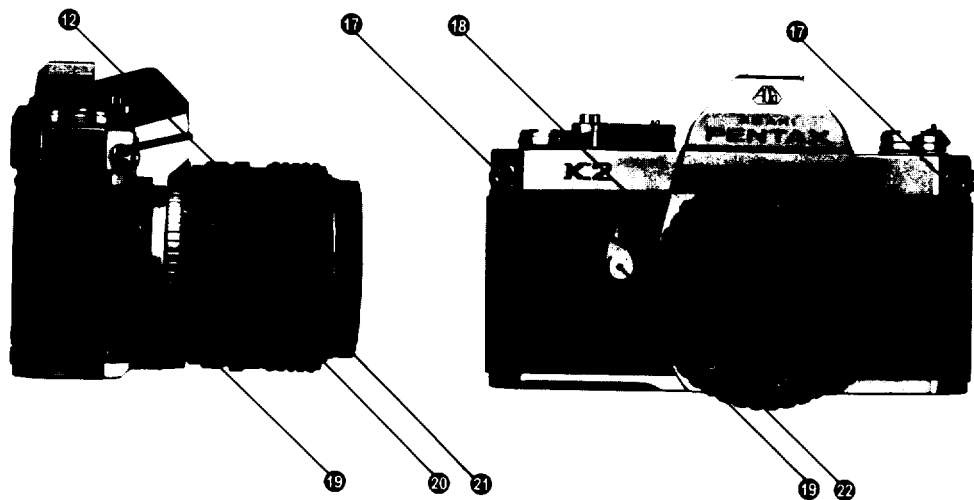

- | | | |
|----------------------------------|-----------------------------|------------------------|
| 17 Strap ring lug | 26 FP flash terminal | 35 Battery chamber |
| 18 Depth-of-field preview button | 27 X flash terminal | 36 Film chamber |
| 19 Lens release lever | 28 Accessory fitting groove | 37 Tripod receptacle |
| 20 Exposure factor dial | 29 Battery check button | 38 Shutter leaves |
| 21 Focusing ring | 30 Battery check lamp | 39 Film rail |
| 22 Self-timer lever | 31 Film guide rail | 40 Film rewind button |
| 23 ASA ring | 32 Viewfinder eyepiece | 41 Film roller |
| 24 ASA ring lever | 33 Sprocket | 42 Back cover |
| 25 Mirror lock-up lever | 34 Film take-up spool | 43 Film pressure plate |

ASAHI
PENTAX K2

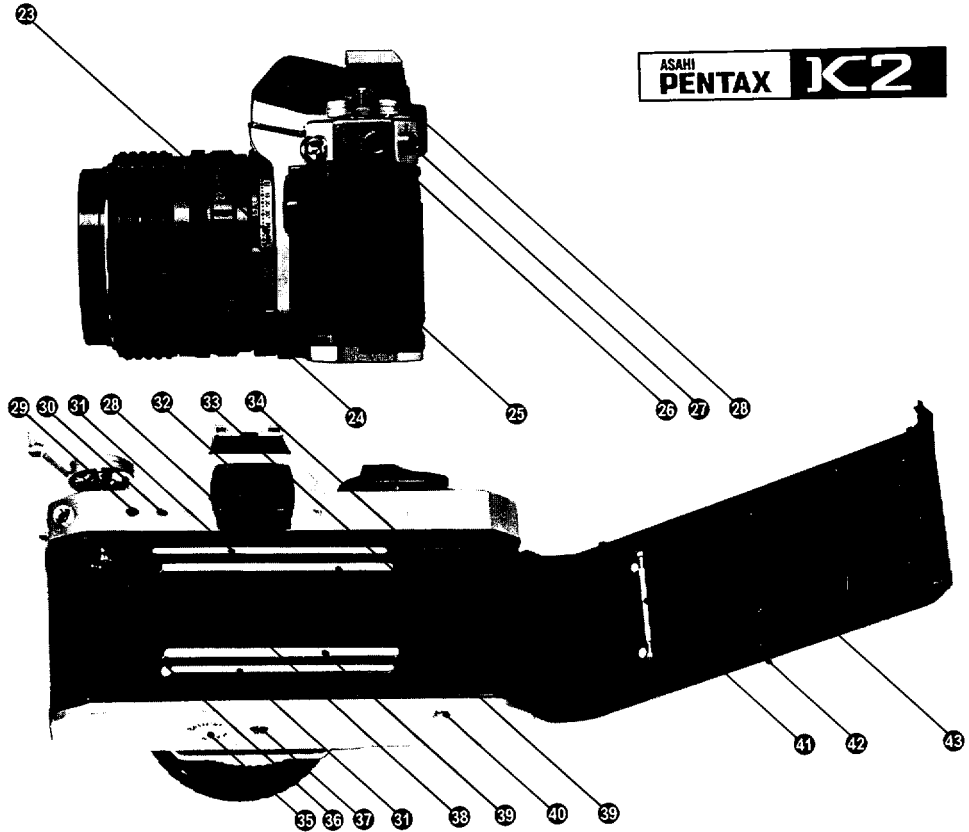

Type	35mm SLR with through-the-lens light meter and vertical electronic focal-plane shutter.
Film and Picture Size	Exposure control fully automatic or manual. 35mm film. 24mm x 36mm.
Standard Lenses	SMC Pentax 50mm f/1.2, 50mm f/1.4 and 55mm f/1.8 with fully-automatic diaphragm. Minimum aperture: f/22. Filter size: 52mm.
Shutter	Focusing: 0.45m (1.5 ft.) to infinity. Vertical run, metal focal-plane shutter. Shutter button lock provided. Automatic electronic shutter: stepless between 8 and 1/1000 sec. Manual electronic shutter: 8, 4, 2, 1, 1/2, 1/4, 1/8, 1/15, 1/30, 1/60, 1/125, 1/250, 1/500, 1/1000 sec. Manual mechanical shutter: B, 1/125 sec. (when battery is dead.)
Flash Synchronization	X contact hot shoe for cordless flash connection. FP + X contacts for conventional flash cord connection. X synchronization at 1/125 sec.
Self-timer	Built-in self-timer with interrupt function. 5 – 9 sec. delay after tripping shutter release.
Viewfinder	Pentaprism finder with cross-microprism or split-image focusing screen. 0.88x magnification with 50mm lenses (life-size with 55mm lens). 95% field of view. Dioptry -0.8. "Incorrect exposure range" indicator.
Focusing	Turn focusing ring until viewfinder image comes into focus.

Reflex Mirror	Swing-up-and-back, instant-return type, with mirror lock-up lever, and special shock absorbers for minimum vibration
Film Advance	Single-stroke wind lever. 25° pre-advance and 130° advance angles.
Exposure Counter	Automatic re-set.
Film Rewind	Rapid-rewind crank lifts clear of body.
Lens Mount	Pentax bayonet mount. Rotation: 65°.
Exposure Meter	Silicon Photo Diode-activated, aperture-preferred, through-the-lens meter measures central portion of ground glass at full lens aperture. Match needles for correct exposure on manual. Couples directly to shutter, aperture and film speed settings. Shutter speed and auto/manual setting visible in viewfinder for exposure doublecheck.
Exposure Control	Exposure factor control dial: 4x, 2x, 1x, 1/2x, 1/4x for specific exposure control.
Power Source	Two 1.5V silver oxide batteries (Eveready S76E or Mallory MS76H).
Meter Switch	Meter is ON when shutter button is depressed halfway. Also, when film wind lever is at its pre-advance angle and shutter button is depressed halfway, meter stays ON. Battery check button and lamp provided.
Dimensions	With 50mm f/1.4 lens: width 144mm (5.7") x height 92mm(3.6") x depth 94mm (3.7").
Weight	946g (33.7 ozs.) with 50mm f/1.4 lens. 680g (24.2 ozs.) with no lens.

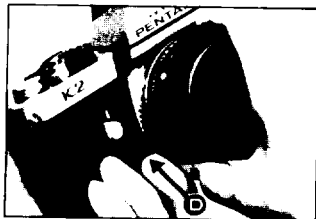
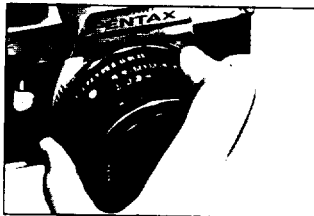
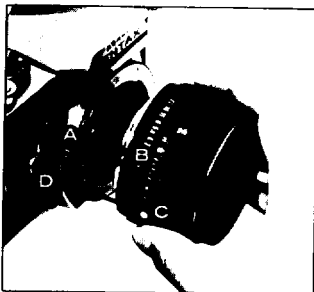

1. Remove the rear lens and body caps.

2. Match the red dot **A** on the camera body with the red dot **B** on the lens. Insert the lens into the body and turn it clockwise until the lens locks with a click.

3. In the dark, when the red dots are difficult to see, align the white plastic bump **C** on the lens barrel with the lens release lever **D** by touch. Then turn and lock as above.

4. To detach, hold the camera with your left hand. Depress the lens release lever **D** while turning the lens counter-clockwise with your right hand.

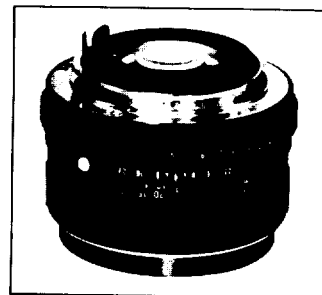

If you have to put the lens down without the rear lens cap, place it only on its front end, never on the rear.

When changing lenses outdoors with film in the camera, avoid direct sunlight.

Two silver oxide batteries are packed separately. Be sure to insert them into the battery chamber before operating the camera.

*Handle only edge
of batteries. Never
touch center as it
carries them to
lose life.*

Do not push the check button too often, as it will exhaust the batteries. The battery is like a phonograph record. It can be damaged by skin acids. Handle by the edges with a dry cloth before insertion into the camera. The battery is not rechargeable. Do not throw a dead battery into fire, as it may explode. Also, keep it beyond the reach of small children.

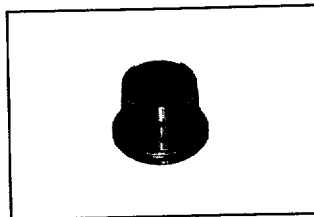
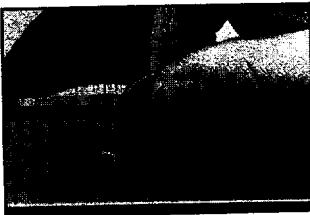

INSERTION

Open the battery chamber cover with a coin. Insert the two batteries into the battery holder of the cover as shown above, each with (+) side facing up. For replacement, use Eveready S76E or Mallory MS76H or equivalent.

CHECK

One set of batteries will last about one year or permit about 10,000 electronic shutter releases. To check the life, push the battery check button. If the lamp next to the button lights the batteries have sufficient capacity. If not, replace the batteries.

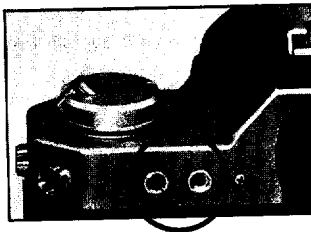

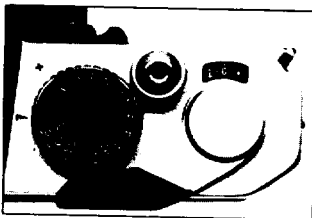
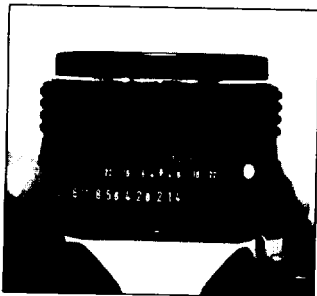

1. Load the film into your camera.
2. Set the exposure factor control dial at "1x" for normal exposure.
3. Set the ASA film speed.
4. Pre-select the aperture.
5. Set the shutter speed dial at AUTOMATIC.
6. Cock the rapid-wind lever all the way until it stops.

7.
Compose and focus by turning the focusing ring.



8.
Slightly depress the shutter button. The electric circuit is now switched on. The meter needle indicates the correct shutter speed. If you want a faster or slower speed, turn the diaphragm ring.



9.
When you depress the shutter button completely, the electronic shutter is released according to the length of time determined by the built-in electronic memory device.

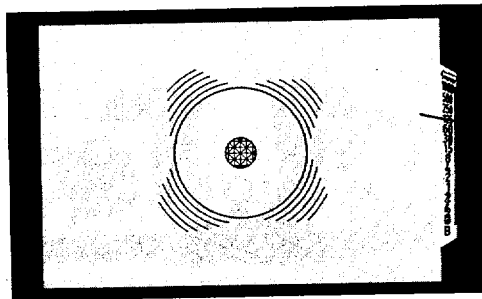

FILM LOADING AND WINDING

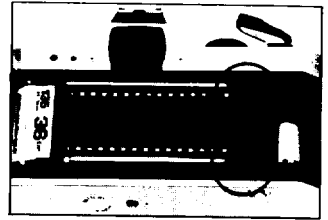
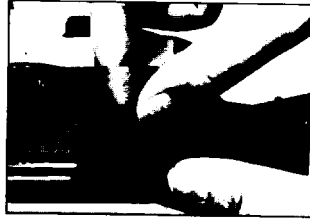
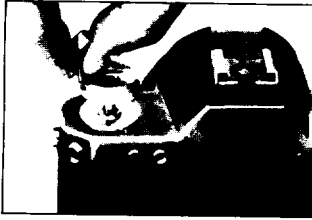

Avoid direct light when loading your film.

1. Open the camera back by pulling up the rewind knob until the back opens.
2. Place the film cassette in the cassette chamber, and push down the rewind knob. Insert the film leader into the slot of the take-up spool.
3. Advance the film by alternately turning the rapid-wind lever and depressing the shutter button until both sprockets engage the film perforations, top and bottom. Close the back by pressing it firmly.
4. Cock the rapid-wind lever, and confirm that the film rewind knob turns counter-clockwise, indicating that the film is properly loaded and is moving from cassette to take-up spool. Trip the shutter. Advance the film until the exposure counter turns to "1", indicating that the first picture is ready to be taken.

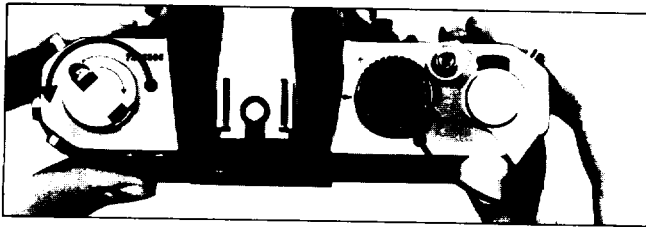

FILM SPEED

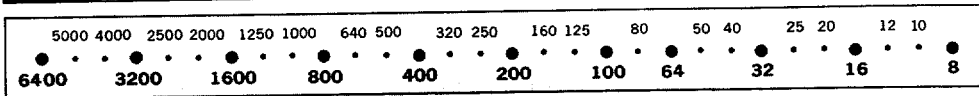
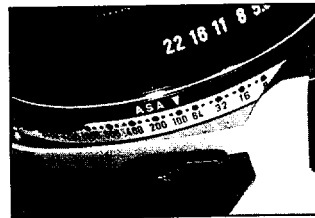
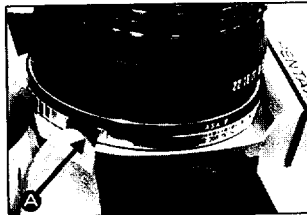
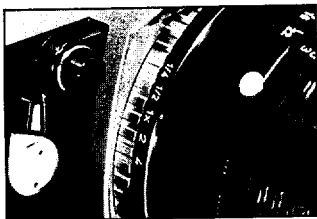

The ASA film speed rating of all 35mm films is given in the data sheet packed with each roll of film. The higher the ASA number, the more sensitive the film is to light.

To set the index, first make sure that the exposure factor dial is set at "1x". While depressing the ASA ring lever , turn the ring until the ASA number of your film is opposite the orange index mark.

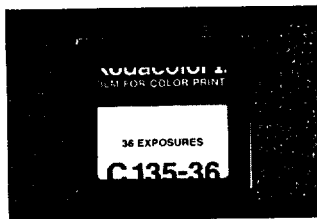

As a reminder of what type of film is in your camera, tear off the top of film box and insert it into the Memo Holder on the back cover of the camera.

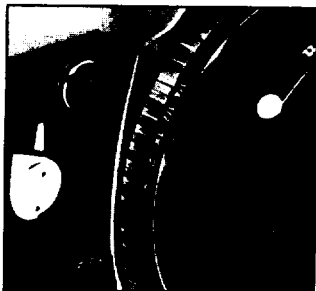

REMEMBER to set the dial at "1x" for normal exposure.

The scale (4x, 2x, 1x, 1/2x, 1/4x) indicates exposure factor. You get "normal" exposure at 1x, while 1/2x and 1/4x automatically program the camera to deliver one half and one fourth the amount of light to the film. The 2x and 4x settings automatically double and quadruple the light reaching the film.



Use this control only when necessary to give intentional over- or under-exposures while operating on "AUTOMATIC." For example, set the dial at 4x or 2x when shooting against the light, and at 1/4x or 1/2x when shooting against dark backgrounds. In addition, the dial can be set between the indicated positions to achieve more specific exposure control.

DIAPHRAGM SETTING

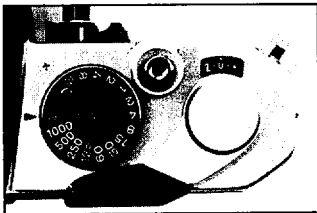

Set the shutter speed dial at the arrow symbol for **AUTOMATIC**. Rotate the diaphragm ring to pre-select the desired aperture such as follows:

Fine weather	f/8 – f/11
Cloudy weather	f/4 – f/5.6
Indoor	f/2 – f/2.8

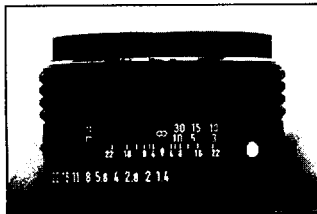

This is a rough guide to acquaint you with the automatic shutter operation. As you get used to it, you will develop your own yardsticks for aperture pre-selection depending on your subject and the lighting conditions.

The shutter speed is automatically determined, within the range of 8 to 1/1000 sec., depending on the amount of light passing through the aperture and the speed of your film.

Set the shutter speed dial at "AUTOMATIC" for automatic electronic shutter operation. (When set on "AUTOMATIC", the exposure system is an aperture-preferred system. For a shutter-speed-preferred system, see MANUAL SHUTTER AND LIGHT METERING, p. 16.)

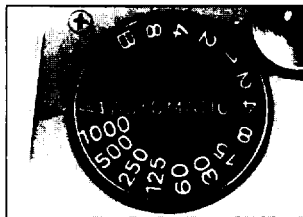

The electronic shutter of the K2 works automatically between 1/1000 and 8 sec. The black numbers seen in the viewfinder refer to fractions of seconds — 1/60, 1/125, etc. The white numbers — 2, 4 and 8 — refer to 2 sec., 4 sec., and 8 sec.

After cocking the rapid-wind lever, press the shutter button slightly to switch on the electric circuit. The meter needle in the viewfinder will indicate the shutter speed which the camera has selected. If the needle does not drop from 1000, close down the lens diaphragm one or more stops. If the needle still does not move, push the battery check button. When the batteries are worn out, the electronic shutter will not function. Moving the shutter speed dial to 1/125 sec. will allow you to continue photographing. (You will have to determine aperture settings without the light meter. Packed in with most types of 35mm film is a data sheet of suggestions for determining the correct exposure in a variety of situations.) But you should carry spare batteries, and replace worn-out batteries immediately.

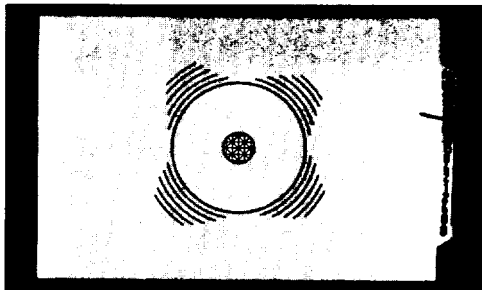

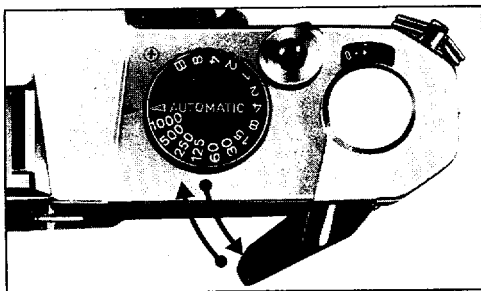

Depress the shutter button completely to shoot. As long as the rapid-wind lever is not closed completely — that is, as long as it is returned to its slightly open, pre-advance position — the meter will stay on and the needle will automatically indicate the speed for the next shot. Once the rapid-wind lever has been completely closed, the meter will be activated only as long as you are depressing the shutter button.

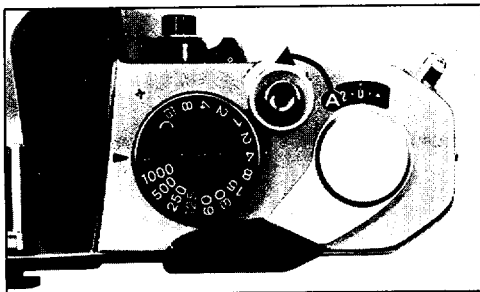

To prevent accidental shutter release, lock the shutter button by moving the lock lever **A** so that the "L" becomes visible.

NOTE: If you should happen to depress the shutter button, while the shutter dial is set at "AUTOMATIC" and the lens cap is on, the reflex mirror may fail to drop back down into place. To bring the mirror down, simply move the shutter dial off "AUTOMATIC."

MANUAL SHUTTER AND LIGHT METERING

Your K2 camera is unique: it also offers manual electronic shutter operation over the full 1/1000 ~ 8 sec. range. This operation is useful for shutter-speed-preferred shooting situation — when you need full control over the shutter speed. To use any of these speeds, depress the shutter dial lock pin **A**, and turn the shutter dial from AUTOMATIC to the desired speed setting.



When you are operating the shutter manually, the blue needle in the viewfinder will indicate the shutter speed you have selected. Depress the shutter button slightly and turn the diaphragm ring until the black meter needle matches the blue needle.

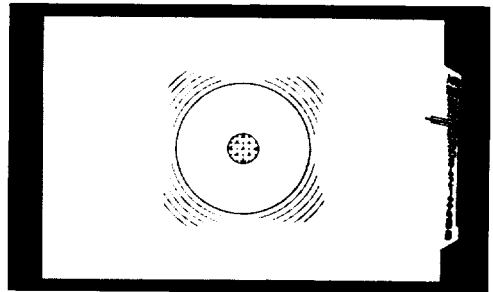

While viewing through the viewfinder, turn the focusing ring until your subject comes into sharp focus. Depending on the type of focusing screen your camera has, there are two ways of doing this.

Cross-microprism focusing system



A cross-microprism focusing system consists of a Fresnel lens, made up of many concentric rings, with a microprism center underneath the ground glass. With this system, when your subject is in focus, the image in the microprism center will be sharp. If your subject is not in focus, the microprism will break the image up into many small dots.

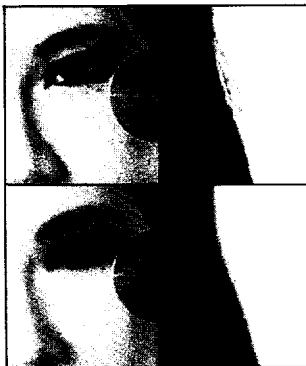

Split-image focusing system

A split-image focusing system consists of a Fresnel lens with a horizontally divided screen under the ground glass. With this system, when your camera is held horizontally and the image is not in sharp focus, all vertical lines seen through the viewfinder will appear to be divided into upper and lower portions. To focus, simply adjust the focusing ring until the upper and lower portions are in perfect alignment.



As a general rule, your camera should be held more firmly in the left hand, which does not release the shutter. If you hold your camera with the right hand — the hand that releases the shutter — this may cause camera movement. Often, blurred pictures are due to camera movement.

Horizontal position A.

Hold the camera firmly with your left hand, and draw your arms close to your body.



Vertical position B.

Hold your camera tightly to your forehead with your left hand, and draw your right arm close to your body.



Vertical position C.

Hold your camera tightly to your forehead with your left hand, raise your right arm and draw your left arm to your body.



UNLOADING

After the final picture on the roll has been taken, the rapid-wind lever will not turn, indicating that the film must be rewound. Lift up the rewind crank. Depress the film rewind release button and turn the rewind crank as indicated to rewind the film into its cassette. Rewind until the tension on the crank lessens, indicating that the leader end of the film has been released from the take-up spool. Pull out the film rewind knob (the back will open automatically), and remove the film cassette.

AVOID DIRECT LIGHT WHEN LOADING OR UNLOADING THE FILM.

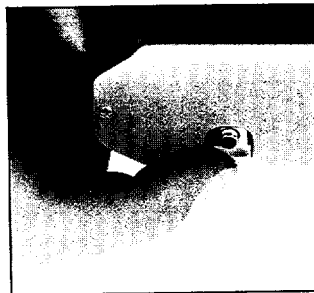
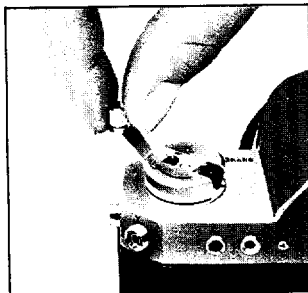

DEPTH-OF-FIELD PREVIEW BUTTON

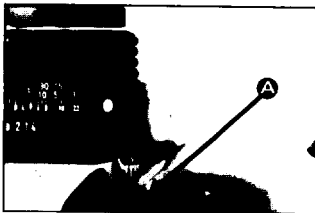

Depth of field is the range between the nearest and farthest distances which are in focus at a given lens aperture.

If you want to know how great the depth of field is at a certain aperture, focus on a subject and look through the viewfinder while depressing the depth-of-field preview button **A**. Or, after focusing, look at the depth-of-field guide on the lens. In the photograph below, the distance scale is set at 5 meters . . . the lens is focused on a subject 5 meters away. The calibrations on each side of the distance index correspond to the diaphragm setting and indicate the range of in-focus distance for different lens apertures. For example, if a lens opening of $f/4$ is to be used, the range on the distance scale covered within the figure 4 on the depth-of-field guide indicates the area in focus at that lens opening. Your will note from the depth-of-field guide in the photograph that the range from approximately 4.5 to 6.5m is in focus. Note that as the lens apertures change, the effective depth of field also changes. For depths of field at different apertures and distance, refer to the next page.

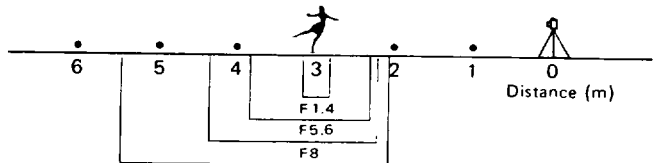

DEPTH-OF-FIELD TABLE: SMC PENTAX 50mm LENS

Distance scale	0.45m	0.6m	1m	1.5m	2m	5m	10m	∞
F1.4	0.45 ~ 0.453	0.59 ~ 0.61	0.98 ~ 1.02	1.46 ~ 1.54	1.93 ~ 2.07	4.57 ~ 5.52	8.40 ~ 12.36	∞
F2	0.45 ~ 0.454	0.59 ~ 0.61	0.98 ~ 1.02	1.45 ~ 1.56	1.90 ~ 2.11	4.41 ~ 5.78	7.86 ~ 13.75	∞
F2.8	0.44 ~ 0.46	0.59 ~ 0.61	0.97 ~ 1.03	1.43 ~ 1.58	1.87 ~ 2.16	4.21 ~ 6.16	7.24 ~ 16.19	25.90 ∞
F4	0.44 ~ 0.46	0.59 ~ 0.62	0.95 ~ 1.05	1.40 ~ 1.62	1.81 ~ 2.23	3.94 ~ 6.84	6.48 ~ 22.05	18.14 ∞
F5.6	0.44 ~ 0.46	0.58 ~ 0.62	0.94 ~ 1.07	1.36 ~ 1.68	1.75 ~ 2.34	3.64 ~ 8.03	5.68 ~ 42.68	12.97 ∞
F8	0.44 ~ 0.47	0.57 ~ 0.63	0.91 ~ 1.11	1.24 ~ 1.89	1.66 ~ 2.52	3.26 ~ 10.87	4.80 ∞	9.10 ∞
F11	0.43 ~ 0.47	0.56 ~ 0.65	0.88 ~ 1.15	1.30 ~ 1.77	1.56 ~ 2.80	2.88 ~ 19.53	4.02 ∞	6.63 ∞
F16	0.42 ~ 0.48	0.54 ~ 0.67	0.84 ~ 1.24	1.16 ~ 2.16	1.42 ~ 3.42	2.42 ∞	3.16 ∞	4.57 ∞

Distance scale	1'6"	2'	3'	5'	10'	15'	30'	∞
F1.4	1'6.12" 1'6.13"	1'11.8" 2' 0.2"	2'11.5" 3' 0.6"	4'10.4" 5' 1.7"	9' 5.6" 10' 7.2"	13' 9.7" 16' 4.9"	25' 6.6" 36' 4.2"	169' 9.2" ∞
F2	1' 5.9" 1' 6.1"	1'11.6" 2' 0.4"	2'11.3" 3' 0.8"	4' 9.8" 5' 2.4"	9' 3.1" 10'10.6"	13' 4.3" 17' 1.2"	24' 0.2" 39'11.8"	118' 3.5" ∞
F2.8	1' 5.8" 1' 6.2"	1'11.5" 2' 0.5"	2'10.9" 3' 1.1"	4' 9" 5' 3.4"	8'11.9" 11' 3.2"	12' 9.6" 18' 1.4"	22' 3" 46' 1.4"	84'11.6" ∞
F4	1' 5.6" 1' 6.4"	1'11.4" 2' 0.6"	2'10.6" 3' 1.7"	4' 7.7" 5' 7"	8' 7.4" 11'11.2"	12' 0.6" 19' 11"	20' 0.4" 59'11.6"	59' 6.4" ∞
F5.6	1' 5.5" 1' 6.5"	1'11.2" 2' 1"	2' 10" 3' 2.3"	4' 6.2" 5' 7.2"	8' 1.9" 12'11.2"	11' 2" 22'10.7"	17' 8.3" 100'1.3"	42' 6.8" ∞
F8	1' 5.4" 1' 6.6"	1'10.8" 2' 1.3"	2' 9.1" 3' 3.4"	4' 4.1" 5'10.9"	7' 6.8" 14' 9.5"	10' 1" 29' 7.2"	15' 0.7" ∞	29'10.2" ∞
F11	1' 5.2" 1' 7"	1'10.4" 2' 1.9"	2' 8.2" 3' 4.8"	4' 1.6" 6' 4.2"	6'11.3" 18' 0.6"	8'11.8" 46' 9.7"	12' 8.4" ∞	21' 9" ∞
F16	1' 4.8" 1' 7.3"	1' 9.7" 2' 2.9"	2' 6.7" 3' 7.6"	3' 10" 7' 3"	6' 1.2" 28' 7.6"	7' 7.2" ∞	10' 1" ∞	15' ∞

MIRROR LOCK-UP

In normal picture-taking situations, when you trip the shutter, the reflex mirror swings up out of the way. It then automatically drops back down into place. Inevitably, this causes a small amount of vibration – and the longer the lens you use, the more noticeable the vibration will be.

To avoid this vibration, it is possible to lock the mirror up. (Note: Moving the mirror keeps light from the viewfinder and exposure system, so focusing and setting of the aperture must be done before lock-up. Use manual exposure setting, which, unlike AUTOMATIC, will not be affected by mirror movement. Also, you should use a tripod for this kind of shooting.)

Once everything is set, simply push up the lock-up lever **A**. The mirror will now stay up even after you trip the shutter. To release the mirror, return the lock-up lever to its original position.

The reflex mirror can be locked up either before or after you advance the film.

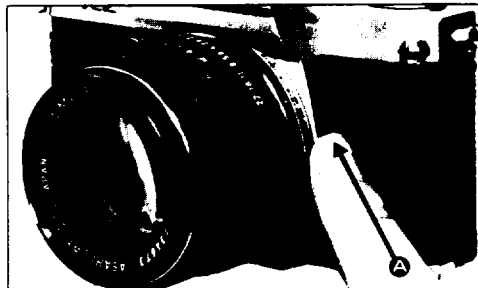

SELF-TIMER

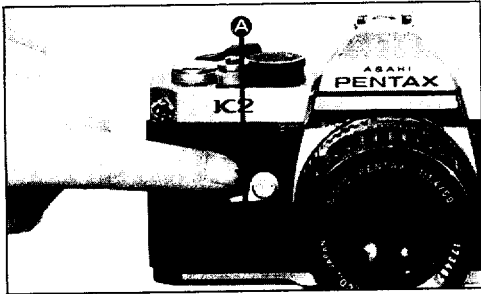

The self-timer delays shutter release between 5 and 9 seconds, depending on how far counter-clockwise you have turned the self-timer **A**. (This can be done on either "AUTOMATIC" or manual shutter speed settings. However, when the camera is set on "AUTOMATIC", some stray light may enter through the viewfinder. To prevent this, we recommend using the inexpensive optional accessory, Viewfinder Cap.)

To operate, turn the self-timer lever down until it stops. Depress the shutter button and the self-timer will start.

The K2 self-timer also has an interrupt function. Even after the self-timer has started to run, you can stop it by moving the self-timer lever back to its normal position. The remaining time will tick away, but the shutter will never be tripped. To re-start the self-timer, push the lever down again, and again depress the shutter button.

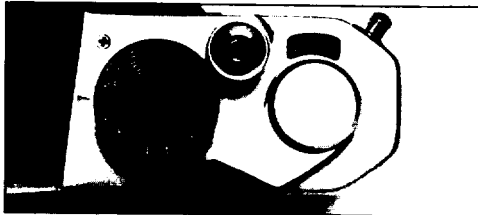
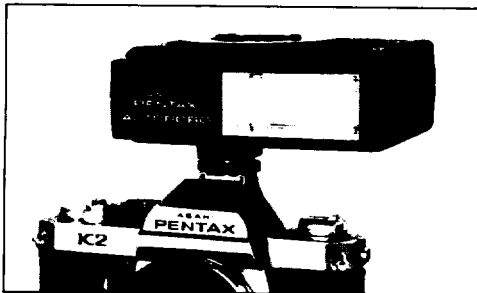

The K2 has FP and X terminals near the film rewind knob, and a separate X contact on the built-in hot shoe. The table on the next page shows which flash contact, which shutter speed and which flash bulb may be combined for maximum lamp efficiency. Unless these combinations are rigidly followed, there will be a failure in flash synchronization. Note the "X" setting is exactly at the 1/25 mark on the speed dial. This indicates the highest shutter speed at which electronic flash units may be used. Use the hot shoe flash contact when using a shoe-mount electronic flash like the Pentax Autorobo which also has a flash contact on the shoe bracket. When using the hot shoe, there is no need to plug the flash cord into the X terminal on the body front. The hot shoe flash contact turns to "hot" (switched on) only when you insert a shoe-mount electronic flash. It remains "cold" (disconnected) even when using an electronic flash with its cord plugged into the X terminal on the body front. This eliminates the danger of electric shocks.

INFRA-RED

If you intend to take infra-red photographs, remember to use the infra-red index marked with an orange line on the depth-of-field guide.

First, bring your subject into clear focus.

Then determine the lens-to-subject distance from the distance scale on the lens. Then match your lens-to-subject distance to the infrared index by turning the distance scale accordingly. For instance, if your subject is in focus at infinity, turn the distance ring and move the infinity (∞) mark to the index.

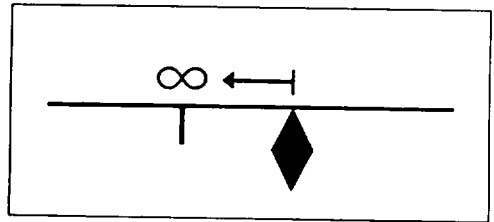
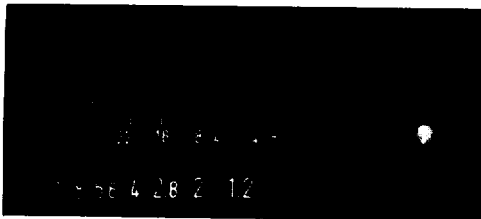

MULTIPLE EXPOSURE

For deliberate multiple exposures, make the first exposure in the normal way. Then tighten the film by turning the rewind knob **A**, and keep hold of the rewind knob. Depress the film rewind release button **B** and cock the rapid-wind lever.

This cocks the shutter without advancing the film. Finally, release the shutter to make the second exposure. Then make one blank exposure, before taking the next picture, to avoid overlapping. Exposure counter registration may not be exact.

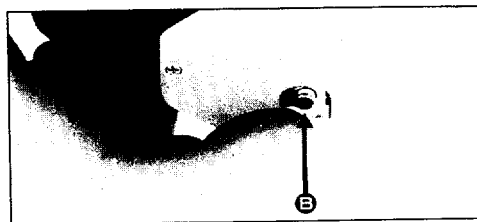
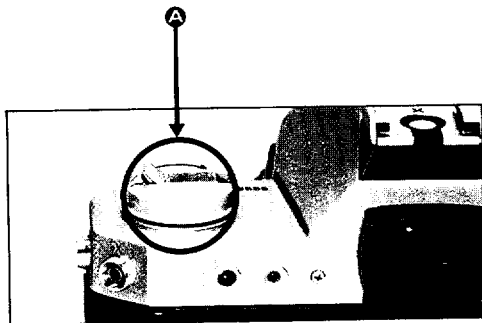

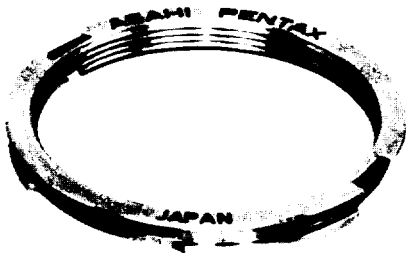

Conventional screw-mount Takumar lenses (both Super-Takumar and SMC Takumar) can be easily mounted onto your camera by attaching them first to a Mount Adaptor K. Use of the Mount Adaptor K does not affect any aspect of normal lens function except as regards the following two points:

1.

Due to the difference in coupling systems, the automatic diaphragm will not function.

2.

Full-aperture metering lenses will function as stop-down metering lenses.

HOW TO USE MOUNT ADAPTOR K

1. Screw the conventional Takumar lens into the Mount Adaptor K.
2. Attach the Adapter/lens unit to the camera body by aligning the red dots **A** and **B**, and turning the lens clockwise until it locks with a click. (This takes slightly less than a quarter of a revolution.)
3. To remove only the lens, leaving the Mount Adapter K attached to the camera body, simply unscrew the lens counter-clockwise. Other screw-mount Takumar lenses can then be attached in the normal way.

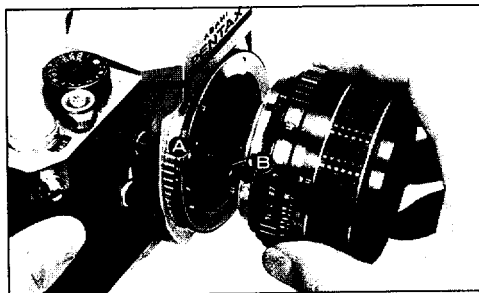

1. To remove the Mount Adaptor K from the camera body, first remove the screw-mount lens. Then press, with your thumbnail or a pointed object such as a ballpoint pen, against the spring pin **C**.
2. Turn the Mount Adaptor K counter-clockwise until you feel it release, and take it out.

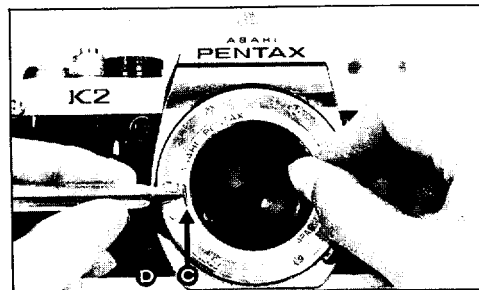

3. Since the mechanism for locking in the Mount Adapter K is totally different from that which locks in an SMC Pentax bayonet-mount lens, the lens release lever **D** on the camera body plays no part at all.

Open-aperture SMC Pentax lenses have a diaphragm coupling lever **A** on the back of the lens which locks into the camera body to permit open-aperture metering. The super telephotos do not have a diaphragm coupler, so they must be used with the stop-down metering system. Use of the Auto-Extension Tube Set K permits open-aperture metering. It can also be set to stop down the diaphragm automatically. Use of other K Series accessories — standard Extension Tube Set K, Helicoid Extension Tube K, Auto-Bellows K and Bellows Unit K — requires stop-down metering. Whenever any one of these is used between the camera body and an SMC Pentax lens, the stop-down metering system must be used.

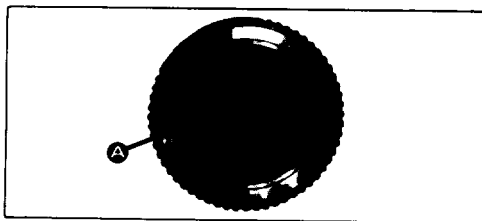

OPEN-APERTURE METERING LENSES

SMC Pentax Fish-eye	17mm	f/4
SMC Pentax	15mm	f/3.5
SMC Pentax	20mm	f/4
SMC Pentax	24mm	f/3.5
SMC Pentax	28mm	f/3.5
SMC Pentax	35mm	f/2
SMC Pentax	35mm	f/3.5
SMC Pentax	50mm	f/1.2
SMC Pentax	50mm	f/1.4
SMC Pentax	55mm	f/1.8
SMC Pentax	85mm	f/1.8
SMC Pentax	105mm	f/2.8
SMC Pentax	120mm	f/2.8
SMC Pentax	135mm	f/2.5
SMC Pentax	135mm	f/3.5
SMC Pentax	150mm	f/4
SMC Pentax	200mm	f/4
SMC Pentax	300mm	f/4
SMC Pentax Zoom	45 – 125mm	f/4
SMC Pentax Zoom	85 – 210mm	f/4.5
SMC Pentax Macro	50mm	f/4
SMC Pentax Macro	100mm	f/4

STOP-DOWN METERING LENSES

SMC Pentax	400mm	f/5.6
SMC Pentax	500mm	f/4.5
SMC Pentax	1000mm	f/8
SMC Pentax Zoom	135 – 600mm	f/6.7

RESISTANCE TO TEMPERATURE EXTREMES AND CHANGES

The temperature range at which your camera will continue to function properly stretches from 50°C to -20°C. However, resistance to cold could be hampered by oil which has become dirty. Therefore, if the camera is to operate at full efficiency in very cold conditions, it must be overhauled and all oil must be replaced.

Sudden changes in temperature will often cause moisture to condense inside or outside your camera. This is a possible source of rust, which may be extremely damaging to the mechanism. Furthermore, if the camera goes from a warm temperature to a sub-freezing one, and if tiny drops of moisture freeze, further damage may be done by their expansion.

Thus, sudden temperature changes should be avoided as much as possible. As a guide, a temperature change of 10°C should be allowed to take place gradually over a period of at least 30 minutes. If this is not possible, keeping the camera in its case or bag will help somewhat in minimizing the effects of a rapid temperature change.

Extremely low temperature reduces the efficiency of the battery. Therefore, the camera should be protected against low temperature. Put the batteries into the camera right before shooting. For extremely low temperature, use new batteries.

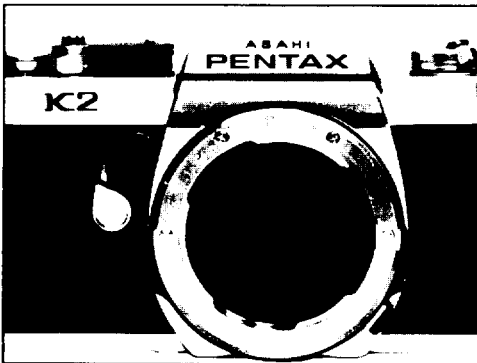

1. Always keep the viewfinder eyepiece, lens and filters as clean as possible. To remove loose dust and dirt, first use the blower and then the brush of a lens brush. Do not try to wipe off granular dirt or dust — it's an excellent way of scratching the glass.

Smudges, such as fingerprints, should be carefully wiped away with either a lens tissue or a clean, soft cloth. Clean, plain cotton handkerchiefs that have already been washed a few times are particularly good for this. Breathing on the lens before wiping is effective; but be sure to wipe away all moisture completely. Commercial lens cleaners are also effective.

2. Never touch the mirror or the shutter leaves with your hands. (The natural acids on your skin are very damaging.— Minor dirt or spots on the mirror will not affect the clarity of your pictures.

3. Take care not to drop the camera or knock it against anything solid. Accidents or rough handling can easily damage the internal mechanism, even though externally nothing seems to have been hurt.

4.
Your camera is *not* waterproof. There are several places where water can get inside and do a great deal of damage. Take care to protect both body and lens from rain or splashing water. If your camera should get wet, dry it off immediately with a clean, soft cloth.

Once a camera has become completely soaked, there is often nothing that can be done to make it right again. However, in such a case, take your camera as soon as possible to an authorized Asahi Pentax Service Center.

5.
Where to keep your camera while you are not using it is an important point. The best storage place is cool, dry, clean and well-ventilated. Because of the possible build-up of humidity, it is risky to store your camera in a cabinet or closet. It's also a good idea to keep your camera in its bag or case while you are not using it.

6.
When mounting your camera on a tripod, be sure the tripod screw is no longer than 5.5mm. This is the depth of the tripod screw hole on your camera. If you use a longer screw, you will probably puncture the bottom of the hole, after which the camera will not function properly.

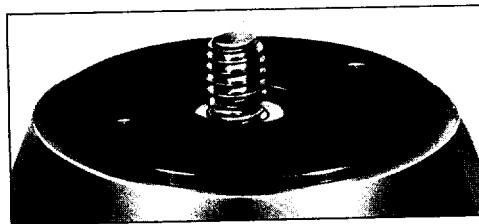

All Asahi Pentax cameras purchased through authorized bona fide photographic distribution channels are guaranteed against defects of material or workmanship for a period of twelve months from date of purchase. Service will be rendered and defective parts will be replaced without cost to you within that period, provided the equipment has not been abused, altered, or operated contrary to instruction. Because the tolerances, quality, and design compatibility of lenses other than Pentax lenses are beyond our control, damage caused by use of such lenses will not be covered by this warranty policy. The manufacturer or its authorized representatives shall not be liable for any repair or alternations except those made with its written consent and shall not be liable for damages from delay or loss of use or from other indirect or consequential damages of any kind, whether caused by defective material or workmanship or otherwise; and it is expressly agreed that the liability of the manufacturer or its representatives under all guarantees or warranties, whether expressed or implied, is strictly limited to the replacement of parts as hereinbefore provided.

PROCEDURE DURING 12-MONTH WARRANTY PERIOD

Any Asahi Pentax which proves defective during the 12-month warranty period should be returned to the dealer from whom you purchased the

equipment or to the manufacturer. If there is no representative of the manufacturer in your country, send the equipment to the manufacturer, with postage prepaid. In this case, it will take a considerable length of time before the equipment can be returned to you owing to the complicated customs procedures required in Japan in importing and re-exporting photographic equipment. If the equipment is covered by warranty, repairs will be made and parts replaced free of charge, and the equipment will be returned to you upon completion of servicing. If the equipment is not covered by warranty, regular charges of the manufacturer or of its representatives will apply. Shipping charges are to be borne by the owner. If your Asahi Pentax was purchased outside of the country where you wish to have serviced during the warranty period, regular handling and servicing fees may be charged by the manufacturer's representatives in that country. Notwithstanding this, your Asahi Pentax returned to the manufacturer will be serviced free of charge according to this procedure and warranty policy. In any case, however, shipping charges and customs clearance fees are to be borne by the sender. To prove the date of your purchase when required, please keep the receipts or bills covering the purchase of your equipment for at least a year. Before sending your equipment for servicing, please make sure that you are sending it to the manufacturer's authorized representatives or their

accredited repair shops, unless you are sending it directly to the manufacturer. Always obtain a quotation of the service charge, and only after you accept the quoted service charge, instruct the service station to proceed with the servicing.

This warranty policy does not apply to Asahi Pentax cameras purchased in the U.S.A. For these cameras, please refer to the separate Warranty Policy card enclosed here.



ASAHI OPTICAL CO., LTD. C.P.O. 895, Tokyo 100-91, JAPAN
ASAHI OPTICAL EUROPE N.V., Weiveldaan 3-5, 1930 Zaventem, BELGIUM
ASAHI OPTICAL EUROPE S.A. (Hamburg Office) 2000 Hamburg 54 (Lokstedt), Grandweg 64, WEST GERMANY
ASAHI OPTICAL (AMERICA) INC. 15 East 26th Street, Suite 1710, New York, New York 10010, U.S.A.
ASAHI OPTICAL BRASILEIRA IND. E COM. LTDA. Rua Estados Unidos, 1053, São Paulo, BRASIL

Free Manuals Download Website

<http://myh66.com>

<http://usermanuals.us>

<http://www.somanuals.com>

<http://www.4manuals.cc>

<http://www.manual-lib.com>

<http://www.404manual.com>

<http://www.luxmanual.com>

<http://aubethermostatmanual.com>

Golf course search by state

<http://golfingnear.com>

Email search by domain

<http://emailbydomain.com>

Auto manuals search

<http://auto.somanuals.com>

TV manuals search

<http://tv.somanuals.com>