

PENTAX[®]

PZ-10

OPERATING MANUAL

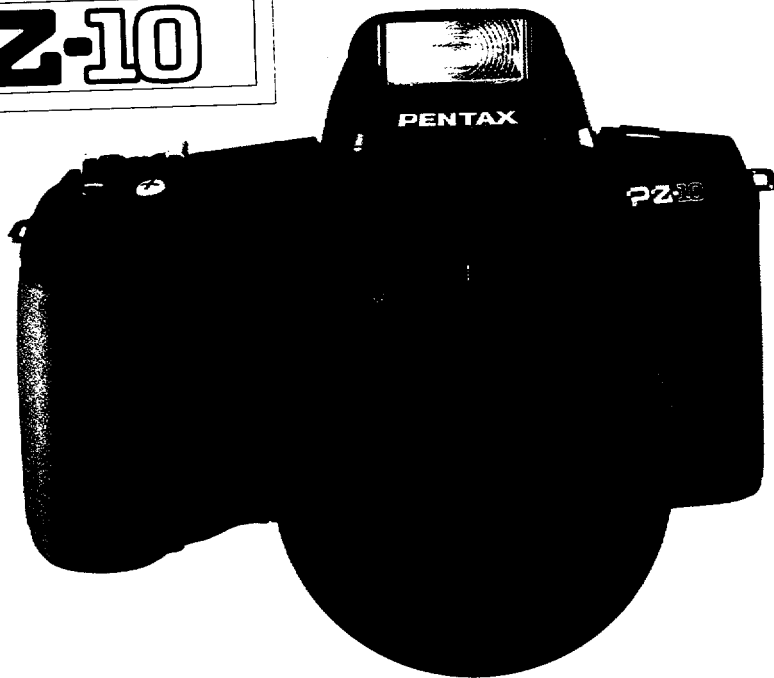

Welcome to the exciting world of Pentax autofocus SLR photography!

This camera is a high-precision, fully automated, autofocus 35mm SLR camera that can be enjoyed mutually by first time users and serious photographer. With state-of-the-art features like Predictive AF Modes and a new dedicated power zoom lens, this camera features a high performance, intelligent, power zoom system that makes it easier for the photographer to create a composition, set the focal length (Zoom Clip Mode), and adjust the magnification (Image Size Tracking Mode). Read this instruction guide carefully for a full explanation of the camera's functions and operations before use.

Commercially available lenses and accessories produced by other manufacturers are not made to our precise specifications and therefore, may cause difficulties with or actual damage to your Pentax camera. We do not assume any responsibility or liability for difficulties resulting from the use of lenses and accessories made by other manufacturers.

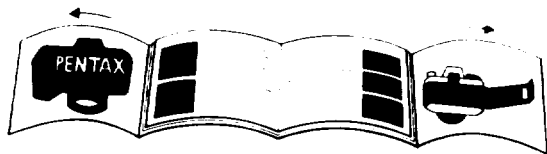

The names of the camera's working parts are listed on the front and back flaps of this manual, so keep the flaps unfolded for quick reference while reading this guide.

We sincerely hope you will enjoy taking memorable, high-quality pictures with this remarkable camera for many years to come.

ABOUT CAMERA / LENS MOUNT

Mount type	Lens type	Camera models
(1) K _{AF2} -mount	Pentax FA lens	Z-10/PZ-10
(2) K _{AF} -mount	Pentax F lens	SFX _N /SF1 _N , SF7/SF10
(3) K _A -mount	Pentax A lens	Super A/Super Program, P30 _N /P3 _N , P30 _r
(4) K-mount	Pentax M lens / Pentax lens	LX, K1000
(5) Screw mount	SMC TAKUMAR lens	ESII, SP

Lenses (1) to (4) are K-mount (bayonet type).

Lenses (1) to (2) are autofocus dedicated lens.

Lenses (3) to (5) are manual focus lens.

Lens (5) is an older screw type lens that is used with K-mount adapter.

Lenses (1) to (3) have an A setting on the aperture ring.

The K-mounts of Pentax FA lenses have the following attachments. They are also compatible with all other K-mount cameras.

K_{AF2}-mount lens <ul style="list-style-type: none"> ⊙ Power contacts for power zoom ⊙ AF coupler ⊙ Lens information contacts 	K_{AF}-mount lens <ul style="list-style-type: none"> ⊙ AF coupler ⊙ Lens information contacts 	K_A-mount lens <ul style="list-style-type: none"> ⊙ Lens information contacts 	K-mount lens
---	---	--	---------------------

TABLE OF CONTENTS

● Names of working parts	Flaps
● Introduction	Front foldout
● About camera/lens mount	Inside cover
● LCD indication	2
● Viewfinder indication	3
● How to use this Guide	4

PREPARATIONS

Fastening camera strap	5
Installing the battery	6
Main switch	7
Mounting the lens	8
Loading the film	10
Soft case	13
Holding the camera & preventing camera shake	14

BASIC FUNCTIONS



Setting autofocus mode	15
Using the autofocus	16
Setting Programmed AE mode	18
Using the Built-in flash	20
Using zoom lenses	23
Unloading the film	26



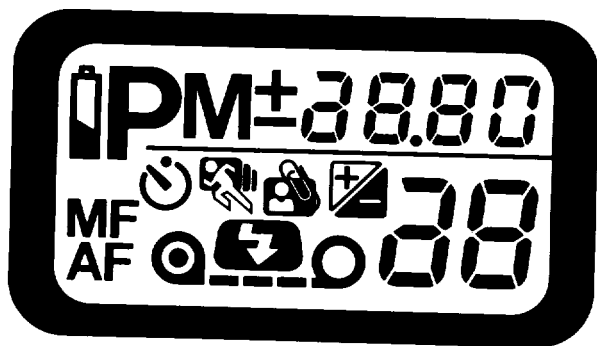

ADDITIONAL FUNCTIONS

Using the self-timer	28
Using focus lock	30
Using FA Zoom Lenses	31
Zoom Clip Mode	32
Image Size Tracking Mode	34
Using Metered Manual Mode	38
Using Bulb Mode	41
Exposure compensation	42
Viewfinder warnings	43
Advanced use of the Built-in flash	44
Using Pentax dedicated flash units	46
Camera functions with various lenses	50
Hard-to-autofocus subjects	51
Manual focusing	52
Focusing in matte area	53
Depth of field	54
Using the infrared Index	55
Precautions on battery	56
Accessories	57
Troubleshooting	58
Taking care of your camera	60
Specifications	62
Warranty policy	64

LCD INDICATION



-  Battery exhaustion warning
- P** Programmed AE mode
- M** Metered manual mode
- MF** Manual focus indicator
- AF** Autofocus indicator
-  Self-timer shooting mode
-  Film transport condition

-  Indicates RTF condition
-  Image size tracking mode
-  Zoom-clip mode
- 36** Exposure counter
- ± 10 Exposure compensation value
- 2000** Shutter speed indicator
-  Exposure Compensation mode
- Hyper-manual mode

1

PREPARATIONS

FASTENING CAMERA STRAP

1

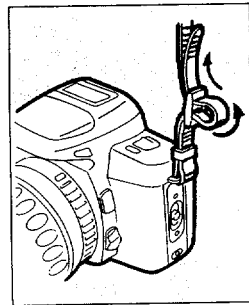
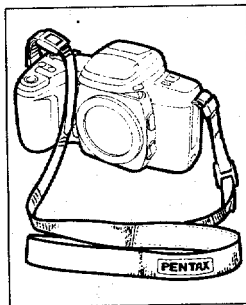

PREPARATIONS

Fasten the strap to the camera body, as shown in the figure.

- * To prevent the camera from swaying excessively while walking, adjust the strap to a length above your waist.

2

INSTALLING THE BATTERY

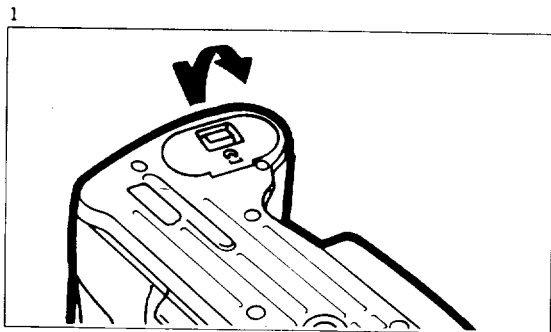

1. Open the cover of the battery chamber by pulling the cover release lever in the direction of the arrow [▶].

Note:

This camera accepts only one lithium battery, type 2CR5.

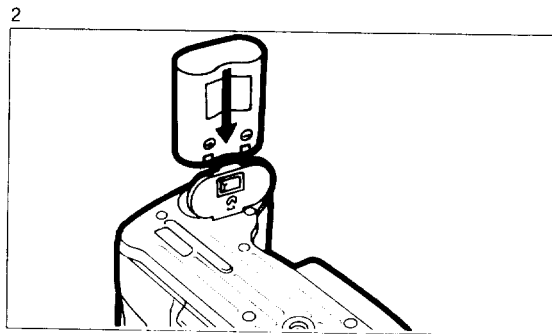

2. Make sure that the polarities of the battery match and then close the battery cover.

MAIN SWITCH

3

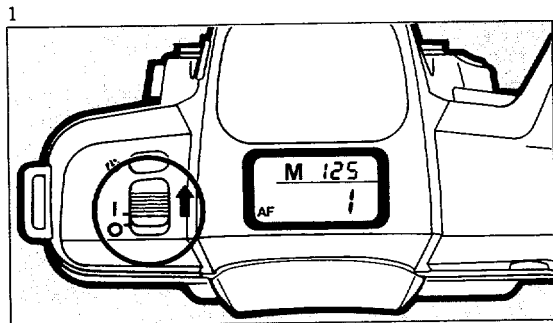

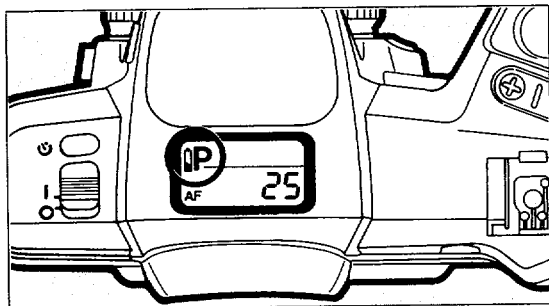

1. To turn on the power, set the Main Switch to [I]. If the LCD panel displays [I], it means that the battery has been inserted correctly.
2. To turn off the power, set the power switch to [O].



PREPARATIONS

Note:

Warning of low battery level

When the battery is low, the [] indicator lights up. Change the battery immediately. When the [] indicator starts blinking, the shutter cannot be released.

- * When the [] indicator lights up, all the LEDs being displayed in the viewfinder also start blinking.

MOUNTING THE LENS

PREPARATIONS

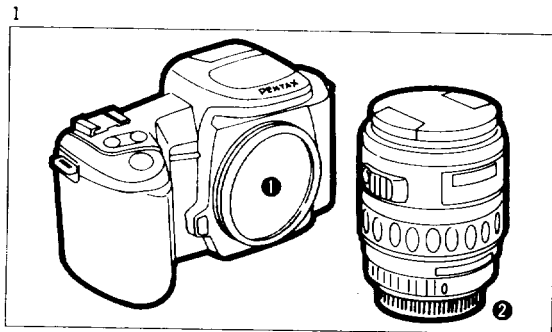

1. Remove the body mount cap ❶ and rear lens cap ❷, as shown in the figure.
- * The body mount cap is designed to prevent scratching and to keep dust out of the camera body. For storage, an optional accessory called "Body Mount Cap K" is available.
 - * To prevent the zoom lens from functioning unexpectedly while mounting FA zoom lenses, turn off the Main switch first.

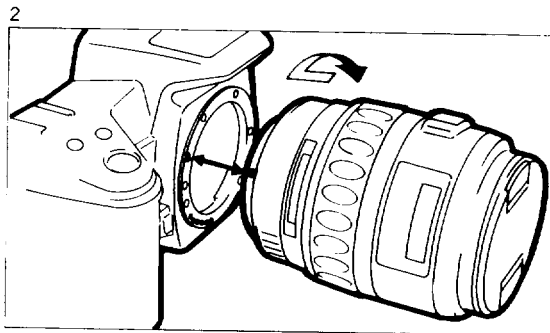

2. Align the red dots on the camera body and the lens. Mount the lens onto the body, and turn the lens to the right. You will hear a clicking sound as the lens mounts into place.

VIEWFINDER INDICATION

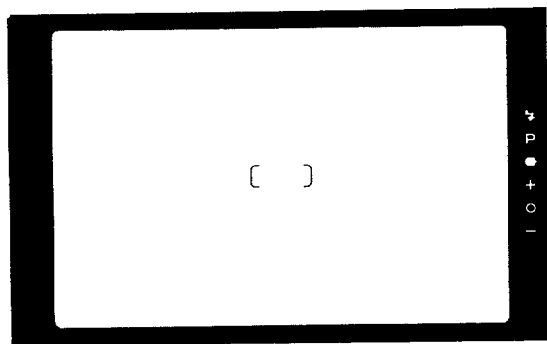

- [] Autofocus frame
- ⚡ Indicates flash condition
- P Programmed AE mode
- In-focus indicator
- + Overexposure warning in manual mode/
Increased exposure compensation in programmed AE mode
- Proper exposure indication in manual mode
- Underexposure warning in manual mode/
Decreased exposure compensation in programmed AE mode

In this Operating Manual, autofocus frame is abbreviated to AF frame.

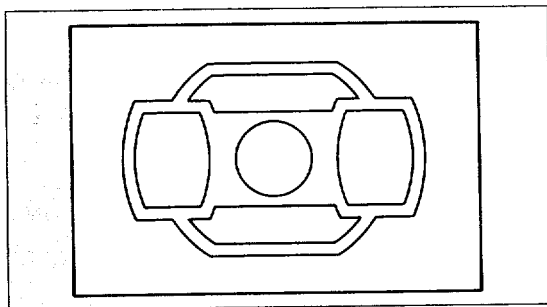

ABOUT THE MULTI(6)-SEGMENT METERING FEATURE...

Multi(6)-segment metering is a method for obtaining optimal exposure of an image by dividing the image into partitions. With averaging metering methods, backlight can cause a subject to be underexposed because the backlight is also read into the overall metering.

In contrast, Multi(6)-segment metering enables the camera to measure and compare light readings in segmented areas of the scene, thereby eliminating underexposure of subjects. Multi(6)-segment metering is a convenient automatic exposure feature that can also be used under high-contrast, and difficult lighting conditions.

HOW TO USE THIS GUIDE

This guide has been divided into the following sections for your convenience.

PREPARATIONS (p. 5)

BASIC FUNCTIONS (p. 15)

ADDITIONAL FUNCTIONS (p. 28)

PRECAUTIONS ON BATTERY (p. 56)

TAKING CARE OF YOUR CAMERA (p. 60)

WARRANTY POLICY (p. 64)

- For first-time users of the SLR camera, start with the "PREPARATIONS" and "BASIC FUNCTIONS" sections. These sections require you to be familiar with general functions of the camera without getting into too much detail.
- Be sure that you read the "PRECAUTION ON BATTERY", "TAKING CARE OF YOUR CAMERA" and "WARRANTY POLICY" sections before using your camera.

3

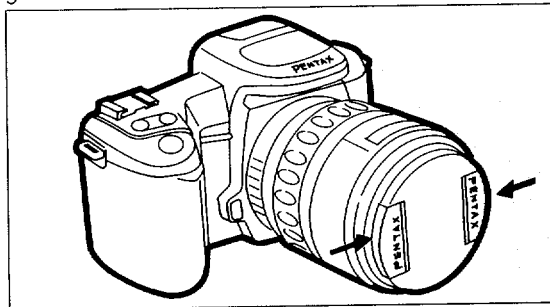

3. To remove the front cap of the lens, press in the tabs on both sides in the direction of the arrow.

Warning:

We do not assume any responsibilities or liabilities for difficulties resulting from the use of lenses from other manufacturers.

*

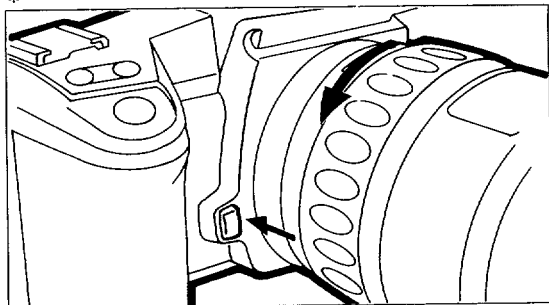

- * To remove the lens, press down on the lens-lock-release button and turn the lens to the left.

Notes:

The lens mounting flange and AF coupler are located on the mounting side of the camera body and lens. Dirt, dust, or mold may cause damage to the electrical system. If your lens should get dirty or smudged, wipe gently with a soft, dry cloth.

To avoid damage to a lens that has been removed from the camera body, place the lens with the mounting flange and coupler facing upward.

LOADING THE FILM

PREPARATIONS

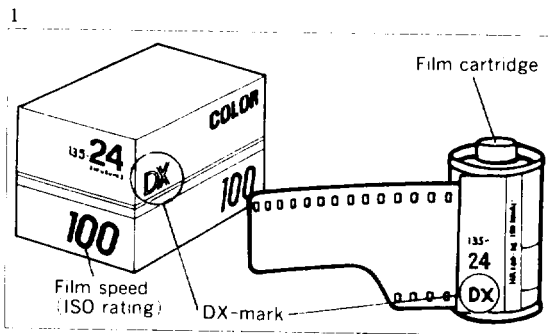

- As shown in the figure, use DX-coded films. The film speed is automatically set. This camera uses ISO25 to ISO5000 film.
 - * Before loading film, make sure the Main Switch is in the off [] position.
 - * Non DX-coded films are set to ISO100.
 - * Always load or unload film in a shade or shield it from direct sunlight with your body.

Warning:

The shutter curtain is a fine-precision mechanism that is very delicate and should never be touched. Accidentally touching with any object may damage the shutter curtain.

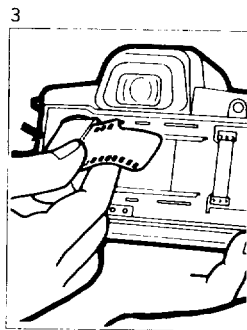
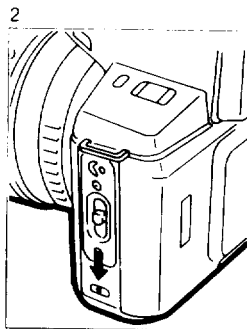

- To open the back cover, push the back-cover-release lever in the direction indicated by the arrow.
- Hold the film cartridge with its protruding side down and slide the upper end in first.

Warning:

When loading film for the first time after purchase of the camera, open the back cover and remove the protection paper shown in the photo. Do not touch the shutter curtain.

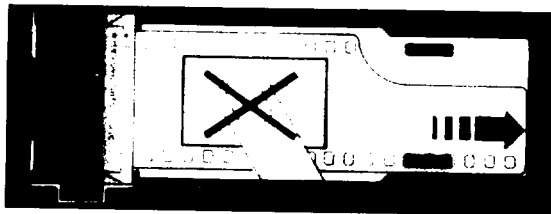

4

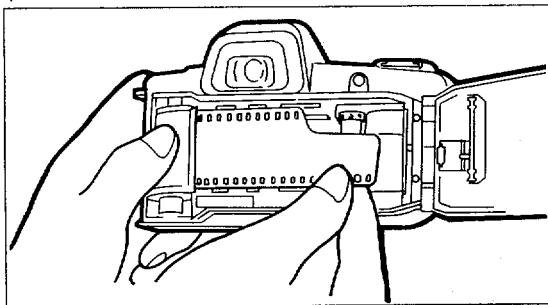

4. While holding the cartridge with your finger, pull out the film leader, as shown in the figure. Make sure that you avoid touching the shutter curtain. If you have pulled out too much film, push it back into the cartridge to reduce the slack.

Warning:

The DX information pins in the film chamber are used as contacts to read film speed, so keep them free of dirt, dust and scratches. To remove smudges, wipe gently with a soft, dry cloth.

5

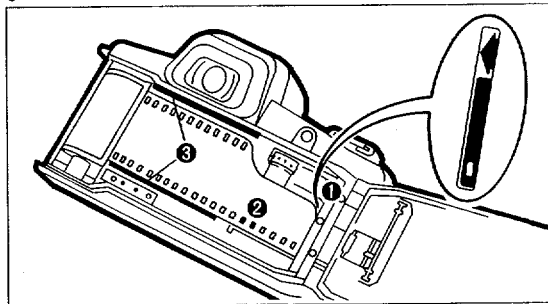

5. Align the film leader with the red mark **1**, as shown in the figure.

Make sure that the film perforations engage the sprocket teeth **2** properly and that the film is inserted between the guide rails **3** (red lines).

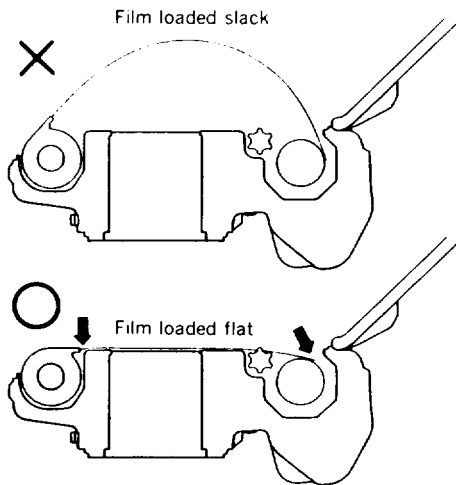

- * If you have pulled out too much film, push it back into the cartridge to reduce the slack.
- * If the film leader is excessively bent, flatten it or cut off the bent portion.

6

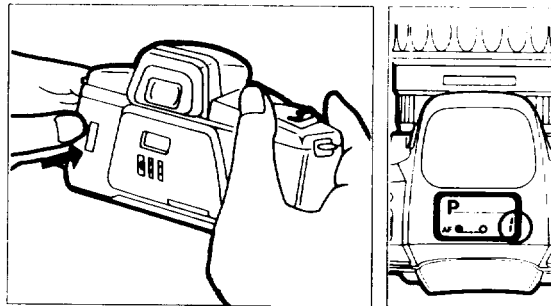

6. Close the back cover and turn on the Main Switch. The camera automatically advances the film to the first frame. Make sure that the LCD panel displays the [/] and [] indications.

Warning:

If the LCD panel displays [Er] and the [] indicator is blinking, the film has been loaded incorrectly. Open the back cover and re-load the film.

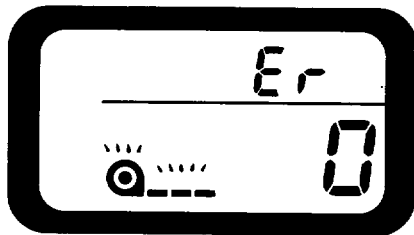

SOFT CASE

6

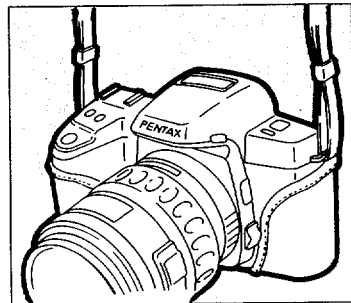
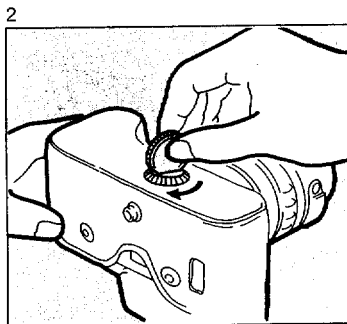
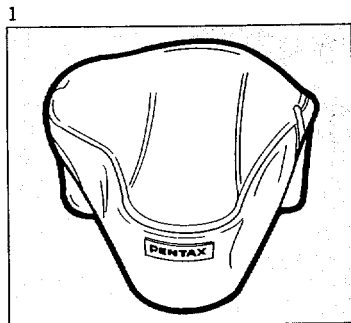

The soft case is available as an option, and consists of a front and back cover piece.

1. Open the front cover and place the camera inside the back cover.
2. Secure the cover to the camera by tightening the fitting screw with a flat circular object, such as a coin.

* The front cover is available in three sizes : S, M and L. Refer to the table for lens and front cover combinations.

Front cover	Applicable F, FA lenses
S	50mmf/1.4, f/1.7, zoom 35-70 mm or any other similar-sized lens
M	Zoom 28-80 mm, zoom 35-105 mm or any other similar-sized lens
L	Macro 100 mm, zoom 70-210 mm or any other similar-sized lens

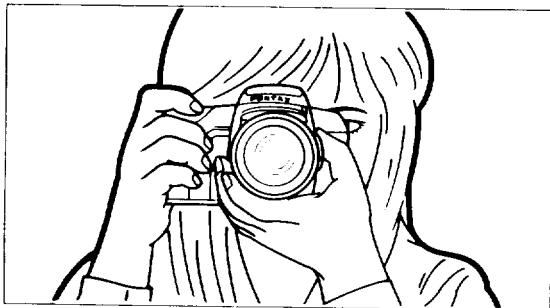

To ensure good results, proper camera handling is important.

- * When taking a picture, hold your breath and gently press down the shutter release button. (Pressing down the shutter release button forcefully can cause camera shake.)
- * For increased balance and support while shooting, place the camera on a flat surface, such as a table.

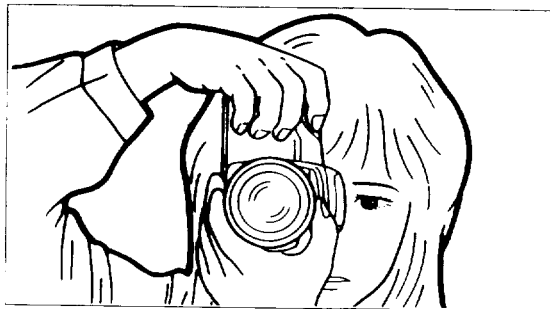

- * When using a slow shutter speed or a telephoto lens, use a tripod and the optional Cable Switch F.
- * When using a tripod with a telephoto lens, use a tripod that is heavier than the camera and lens for better balance and to prevent camera shake.

2

BASIC FUNCTIONS

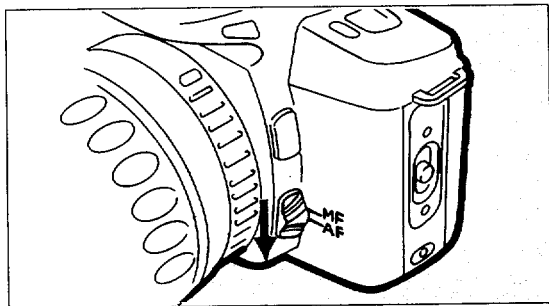

BASIC FUNCTIONS

Adjust the focus lever to the [AF] (autofocus) setting, as shown in the figure.

Press the shutter release button halfway down to focus the lens. The shutter will not be released until the image is focused. For normal use, keep the focus lever at this setting.

* For instructions on manual focus, refer to p.52.

USING THE AUTOFOCUS

1

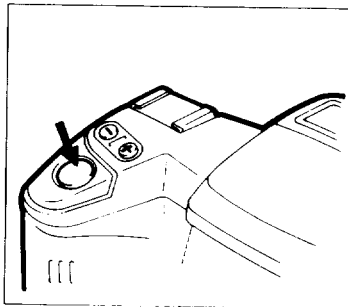

2



*



1. Aim the AF frame at the subject you wish to shoot and press the shutter release button lightly.

2. When the subject comes into focus, a green indicator [] inside the viewfinder lights up, and a beeping tone will be heard.

* If the [] indicator blinks, the camera is unable to focus for the following reasons.

- (1) The subject is too close.
- (2) The subject is not suitable for autofocus (Refer to p.51).

3

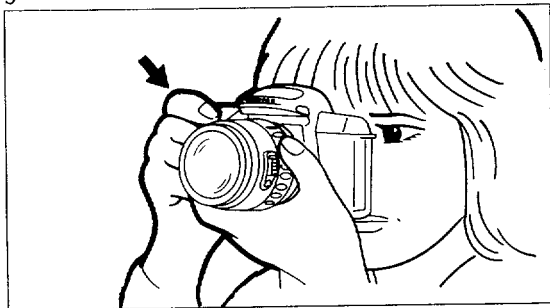

3. Press the shutter release button all the way down to take a picture.

- * The shutter will not release if the subject is not focused.
- * Focusing is fixed as long as you press the shutter release button halfway down with the green in-focus indicator [] on. To focus on another subject, you must lift your finger off the shutter release button and focus again.
- * During autofocus, do not touch the focusing ring of your lens or you will interfere with proper lens movement.
- * When using the SMC Pentax F Soft 85mm f/2.8 lens, set the aperture to f/2.8 to f/4.5. (see page 51.)

4

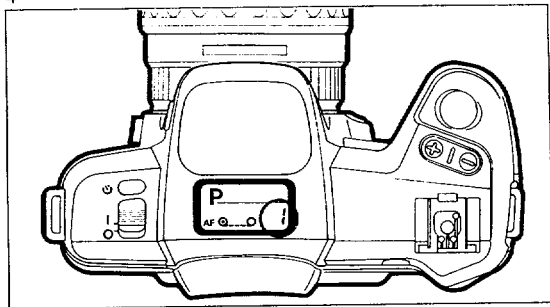

4. The exposure counter increases by one each time the shutter is released.

Predictive Autofocus Mode

- When the camera senses subject movement while pressing the shutter release button lightly, the mode will automatically switch to the Predictive Autofocus mode; the camera drives the lens continuously to maintain focus on the subject.
- If the subject is moving too fast, the shutter may not fire.

3

SETTING PROGRAMMED AE MODE

BASIC FUNCTIONS

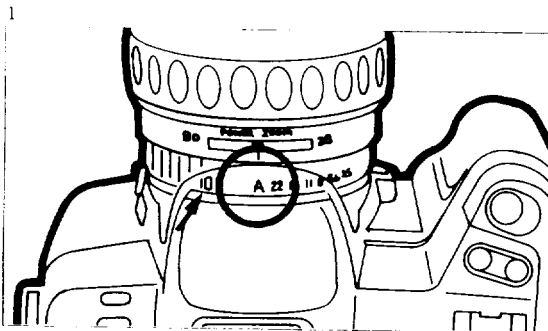

In the Programmed AE mode, the camera selects the shutter speed and aperture automatically. With this convenient function, taking pictures is just a matter of pressing the shutter release button.

1. While pressing the aperture-A lock button, adjust the aperture ring to [A].
- * At the [A] setting, the aperture ring is locked.

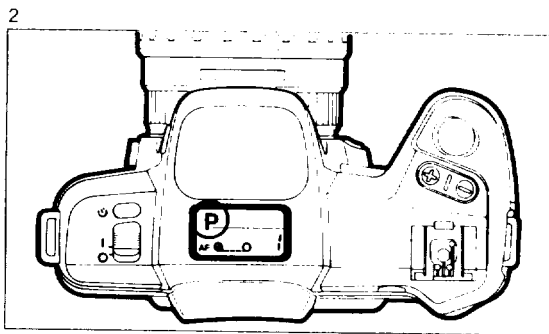

2. Be sure that the [P] setting appears on the LCD panel.

3

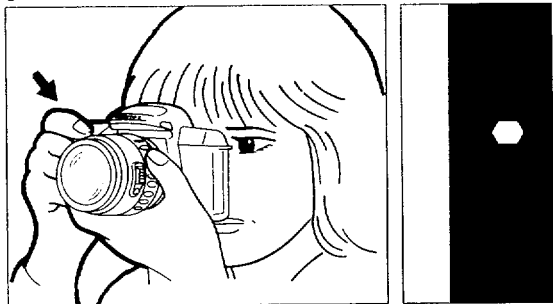

3. Press the shutter release button halfway down while looking through the viewfinder and be sure that the [P] setting appears at the top right corner of the viewfinder.

In the Programmed AE mode, the camera reads the brightness of the subject and selects the aperture and shutter speed automatically for the optimum exposure.

- * For instructions on Metered Manual mode, refer to p.38.

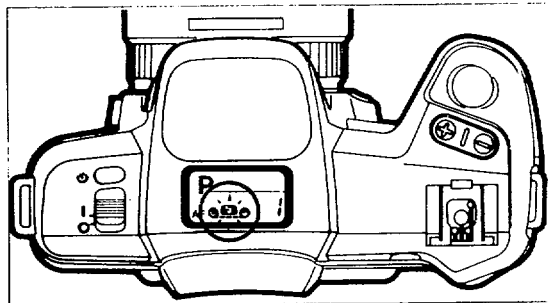

- * When the [P] indicator in the viewfinder and [P] indicator in the LCD panel start blinking, use the built-in flash unit, as explained on pp.20 and 21.

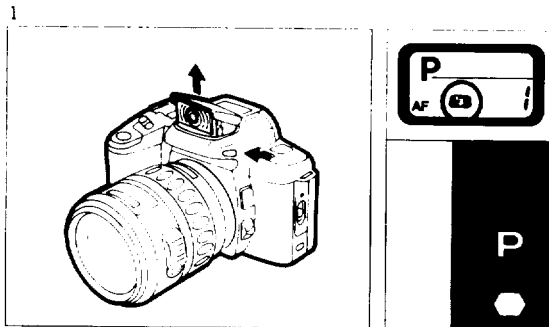
**Note:**

When using the built-in flash, use only lenses with a focal length of 35 mm to 210 mm for proper flash coverage. Do not use the macro lens.

1. Press the [] button to pop-up the flash from the camera body.
- * The flash begins to charge. After charging, the [] indicator appears on the LCD panel. The [] indicator also appears in the viewfinder when you press the shutter release button halfway down.

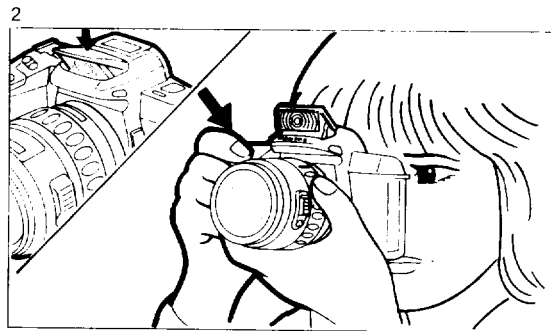

2. Press the shutter release button all the way down to trip the shutter and activate the flash.

Autofocus function cannot be used while the built-in flash is being charged.

- * For instructions on using flash when the aperture is not set to [A], refer to p. 45.
- * In the Programmed AE mode, the built-in flash functions as a programmed TTL auto flash (p. 49).

Effective range for the programmed TTL auto flash

With ISO100 film :

Maximum lens aperture	Distance
f/1.4-2.8	0.9-4.3m
f/3.5	0.7-3.4m
f/4.5	0.7-2.6m
f/5.6	0.7-2.1m



Note:

The range of distance depends on the maximum lens aperture (f-stop).

If the aperture is f/1.4, it is displayed as 1 : 1.4 on the lens.

Tip: on using flash

Using inappropriate lenses

Using flash with the following F or FA lenses will cause a warning indicator [] in the LCD panel and [] in the viewfinder to blink when the shutter button is pressed lightly after the flash has been charged.

Lens focal length shorter than 35mm

Lens focal length longer than 210mm

Macro Lens

Taking pictures while the warning indicators are on causes vignetting in the four corners of the picture due to lack of illumination or semicircular vignetting at the bottom of the picture due to the lens blocking the illumination path of the RTF. The warning indicators will not appear with lenses other than FA or F lenses.

- * Do not use a lens hood as it may obstruct the path of the flash.
- * When shooting at a focal length of 35mm, do not take pictures at a distance less than 1m because light may be distributed unevenly.

Minimizing the Red-Eye Effect

Commonly known as the "red-eye" effect, this phenomenon occurs when taking pictures in a dark environment with a flash, and results in the subject's eyes to turn out reddish. The reason for this phenomenon is that the flash reflects off the retinas of the eyes. This effect cannot be prevented, but certain measures, such as taking pictures in a brighter environment or, when using a zoom lens, shooting wide angle at a closer distance, may help reduce the red-eye phenomenon. When using a Pentax-dedicated flash off the camera, it may also help to position the flash as far away from the camera as possible.



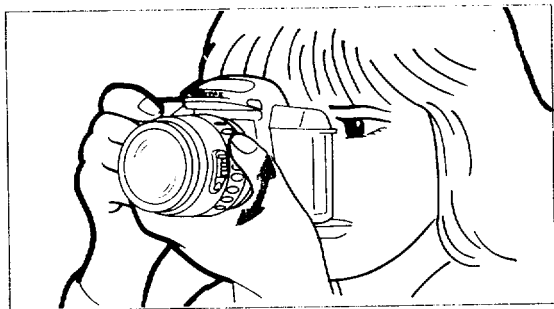

Using the zoom function makes the subject appear larger (telephoto) or smaller (wide angle) in the viewfinder.

- * The smaller the number on the zoom ring, the wider the angle.
Conversely, the bigger the number, the more magnified the image appears.

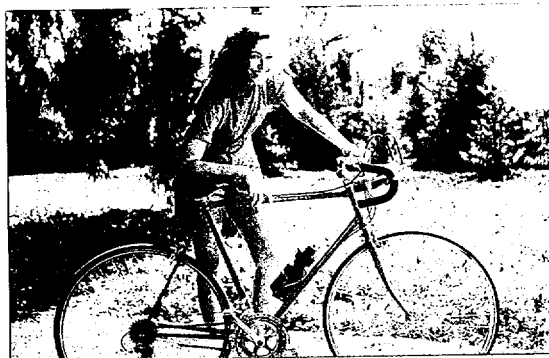

Using FA Zoom Lenses (Power Zoom)

BASIC FUNCTIONS

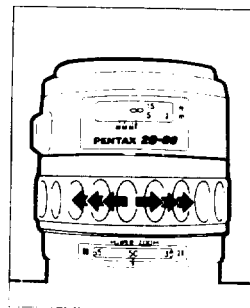
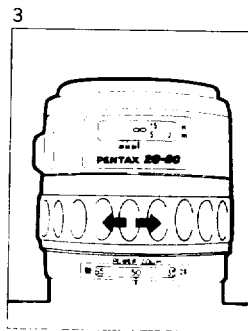
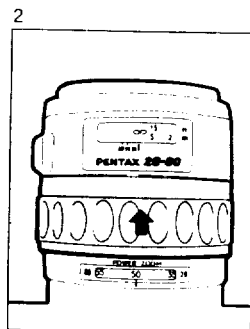
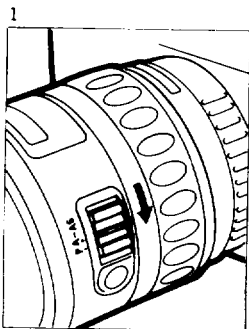

1. Pentax FA lenses are provided with an auto zoom switch. Set this switch at [P] for power zoom.
 2. Push the power zoom ring until [POWER ZOOM] appears on the top of the lens.
 3. Turn the power zoom ring to the right for the telephoto (TELE) mode. Turn to left for the wide angle (WIDE) mode. To stop, release the power zoom ring. You can select one of the three zooming speeds by turning the power zoom ring.
- * The power zoom function can not be used while the built-in flash is charging.
 - * If the power is turned off when a FA zoom lens is mounted on the camera, the lens will automatically withdraw to its smallest length. The focusing ring is moved to the ∞ position and the focal length is set at the minimum lens length position.

Using FA Zoom Lenses (Manual Zoom)

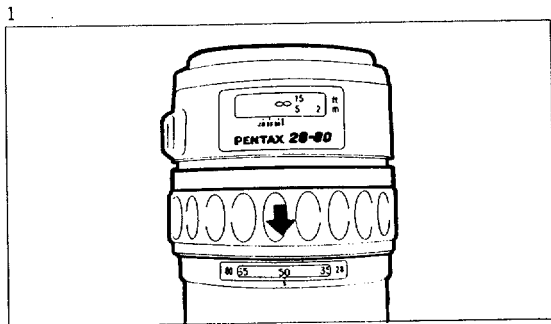

1. Pull the power zoom ring to get out of the [POWER ZOOM] position.

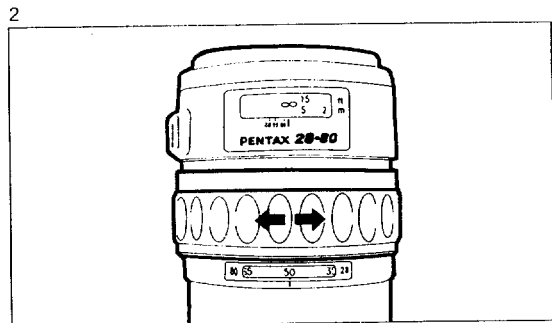

2. Turn the power zoom ring to the left or right to adjust to the desired focal length.

Using the F Zoom lenses

Turn the zoom ring to the left or right to adjust to the desired focal length.

6

UNLOADING THE FILM

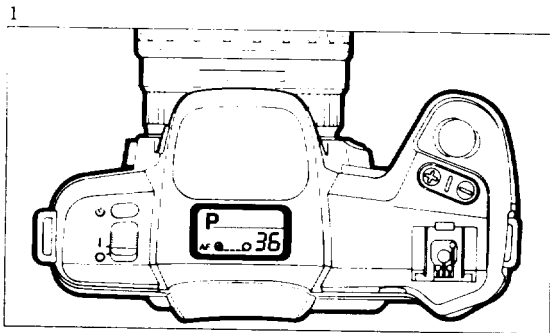

1. The camera automatically rewinds the film when it reaches the end of the roll.
 - * A blinking [] on the LCD panel indicates that the film is being rewind.
 - * The film counter on the LCD panel counts down when the film is rewinding.

Warning

When removing the film, make sure that it is not exposed to direct sunlight.

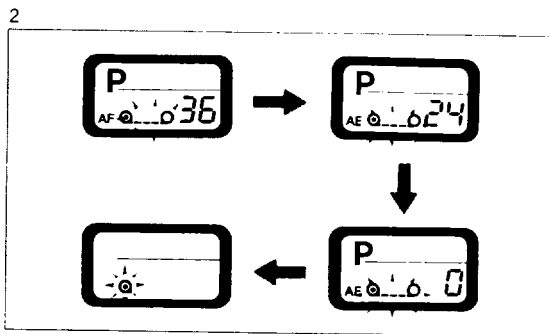

2. After the film is rewind, the [] indicator blinks on the LCD panel, and the film counter clears.
 - * The film counter on the LCD panel counts down when the film is rewinding.

3

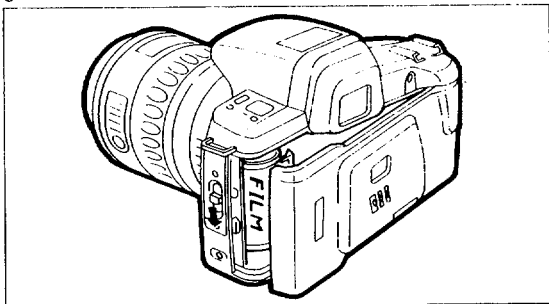

3. Open the back cover and remove the film.

- * It takes approximately 15 seconds to rewind a 24-exposure film.
- * When the camera is not in use, always have the Main Switch off.

Warning:

If the camera stops during rewinding due to battery failure, exchange the battery without opening the back cover.

Note:

You may be able to take more pictures than the specified number of pictures on the film cassette, but those pictures may be cut off in the development process.

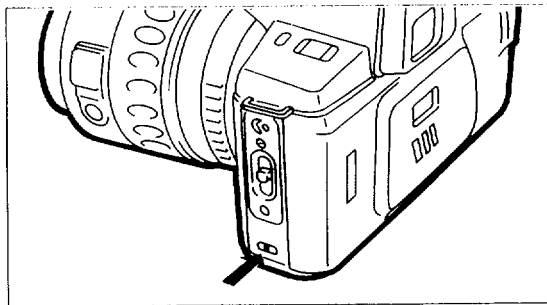

Rewinding the film in mid-roll

This function allows you to remove the film before reaching the end of the roll.

Turn on the Main Switch. Press down on the auxiliary rewind button [] with a blunt object, such as a pen tip, as shown in the figure.

The camera will start rewinding. Before removing the film, make sure that the [] indicator on the LCD panel is blinking.

Now you have mastered the camera's basic operations.

3

ADDITIONAL FUNCTIONS

1 USING THE SELF-TIMER

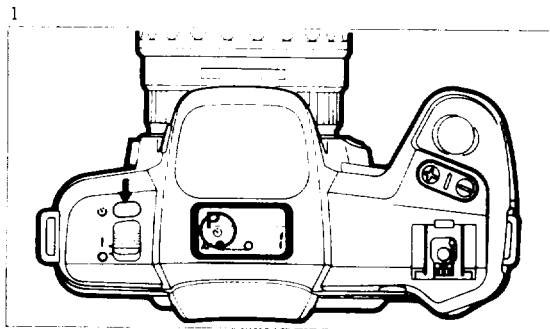

The self timer function delays the firing of the shutter release button. This function is convenient for taking group shots that include the photographer.

1. Press the self-timer button. The [] indication appears in the LCD panel.

2

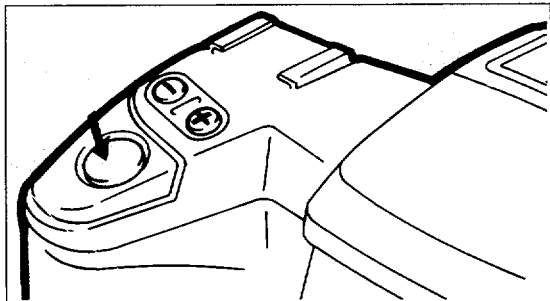

2. Press the shutter release button halfway to focus on your subject, and then press the shutter release button all the way down.

The shutter will be released in about 12 seconds.

- * Focusing on your subject automatically activates the focus-lock function. If your subject is not placed in the center of the viewfinder, refer to the Focus-Lock section in this Operating Manual.
- * An electronic beep sound indicates that the timer has started. The interval of the tone becomes shorter two seconds before the shutter releases.

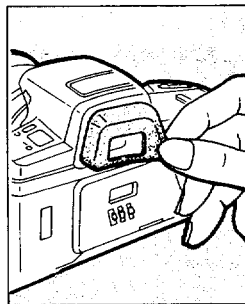

- * To abort the self-timer once it is activated, press the self-timer button again.

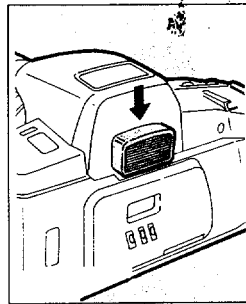



Withdrawing your eye from the viewfinder when the self-timer is activated causes light to enter the viewfinder window, thereby underexposing the film. To avoid light entry, use the viewfinder cap that comes with the camera.

- * When using such accessories as "Diopter Correction Lenses M", "Viewfinder Cap, "etc., remove the Eyecup Fc from the camera.



This camera focuses on the subject that is within the AF frame in the center of the viewfinder.

However, if the composition does not allow the subject to fit inside the AF frame, use focus lock for the camera to "memorize" the focus distance of the subject before arranging your composition.

1. If you take a picture while the [] is not placed on the subject, the focus will be on the background.
2. Place the AF frame on the subject. Press the shutter release button halfway. The [] will light up. If you keep your finger on the release button, the camera will "memorize" the focus.

3. Keeping your finger on the shutter release button lightly, move the camera back to the original composition of the image. Then, without lifting your finger, press the shutter release button all the way down. Moving the camera back to the original composition immediately after the viewfinder indicator [] turns on may cause the camera to enter the Predictive Autofocus mode instead of achieving the focus lock.
- * Lifting your finger from the shutter release button clears the focus lock.
 - * When changing the camera-to-subject distance, take your finger off the shutter release button and re-set focus lock.

CONVENIENT FEATURES USING FA ZOOM LENSES

3

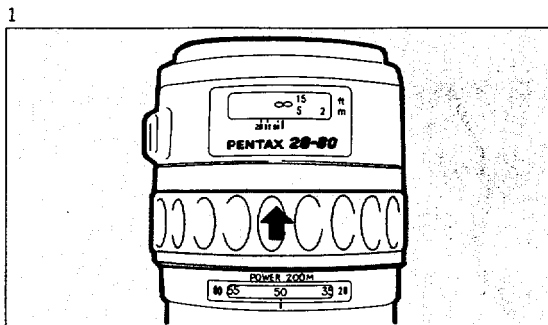

Use of an FA zoom lens will provide you with the two following convenient applications.

- 1) Zoom Clip Mode
- 2) Image Size Tracking Mode

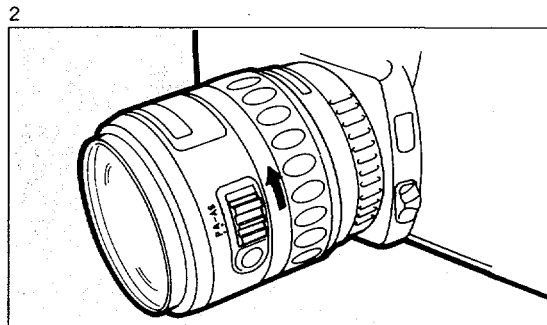

1. Push the power zoom ring until [POWER ZOOM] appears on the top of the lens.

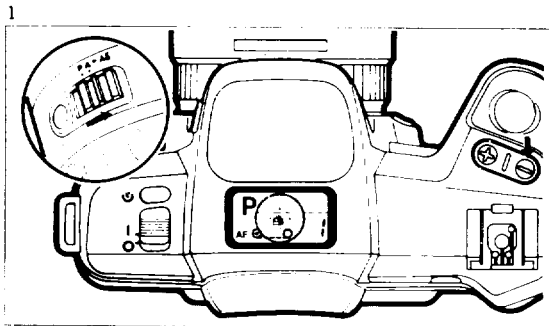

2. Set the auto zoom switch on the lens to [A].



Zoom Clip mode allows you to switch to a given focal length with a single push of a button by presetting the focal length beforehand; you can use this feature when taking a fast-moving sports photo by storing the expected picture area (focal length).

1. Holding the auto zoom switch on the lens in the [AS] position, press the black  button until  blinks in the LCD panel.

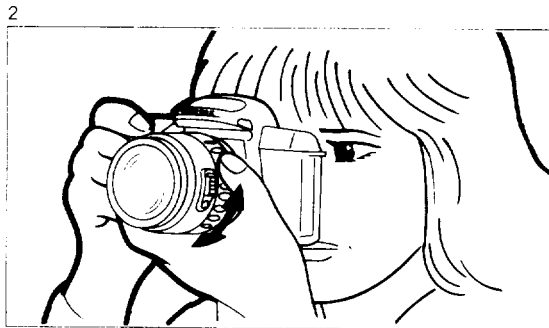

2. Looking through the viewfinder, determine your desired zoom position by rotating the power zoom ring.

3

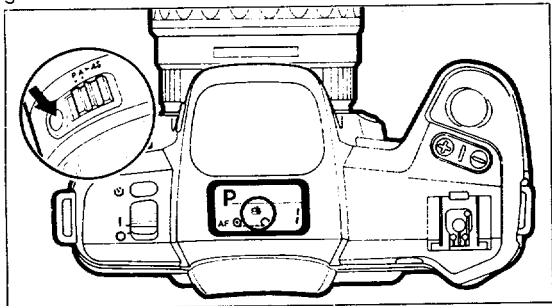

3. Press the Set button on the lens.

- * This stores the zoom position into memory. This also stops the [] from blinking.
- 4. Simply pressing the Set button immediately moves the lens to the memorized zoom position.

4

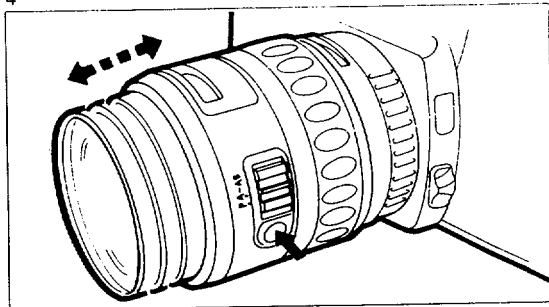

- * The contents stored in memory will not be lost even if the Main Switch is turned off.
- * Removing a lens with the Main Switch turned on will cause the loss of memory ; if you want to keep the contents of memory, turn off the Main Switch first.
- * If you use the same zoom position next time, make sure the [] is displayed in the LCD panel before you press the Set button.
- * If you store another zoom position into memory, the previous position will be erased.

Note:

Removal of the battery will cause the loss of memory

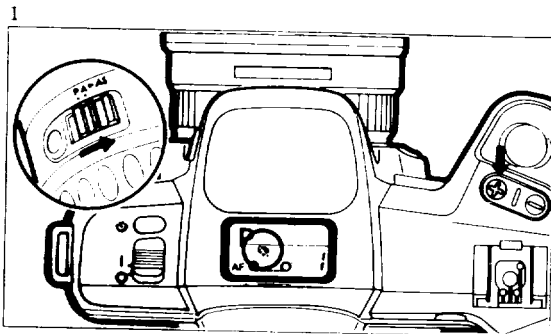

You can define the composition of a picture through the viewfinder and store the image size (**MAGNIFICATION**) so that the camera automatically zooms to always obtain the stored image size (**MAGNIFICATION**) irrespective of the variation of camera-to-subject distance.

You can, for example, take a picture of a child approaching or going farther away, keeping the composition the same image size.

1. Holding the auto zoom switch on the lens in the [AS] position, press the white + button until the [] is displayed in the LCD panel.

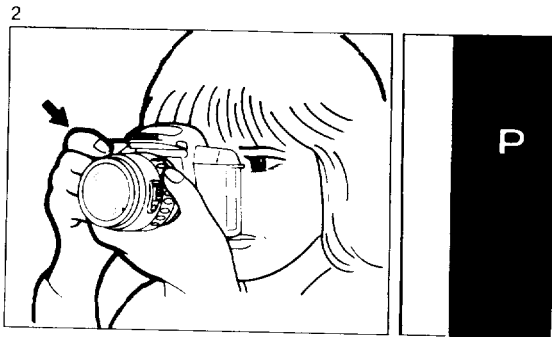

2. Press the shutter release button halfway down to focus on the subject, then maintain this position for a few moment.
- * At this time, the lens will automatically zoom to the memorized image size (**MAGNIFICATION**).

3

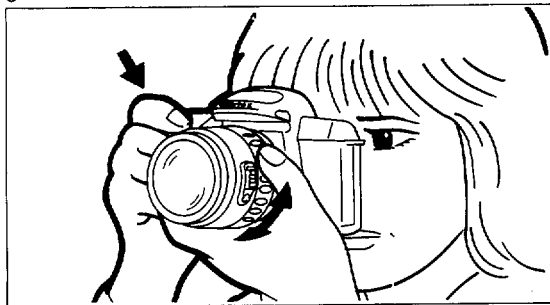

3. If you would like to override the memorized image size (MAGNIFICATION), press the shutter release button halfway down, and turn the power zoom ring to obtain the desired image size (MAGNIFICATION).

- * If you adjust the zoom after focusing, the focus may shift. Should this happen, simply raise your finger off the release button completely and press it down halfway again.
- * In defining the image size, setting the focal length to the middle of its range will provide the most versatility. For example, with the 28-80mm lens, set the focal length to around 50mm.

4

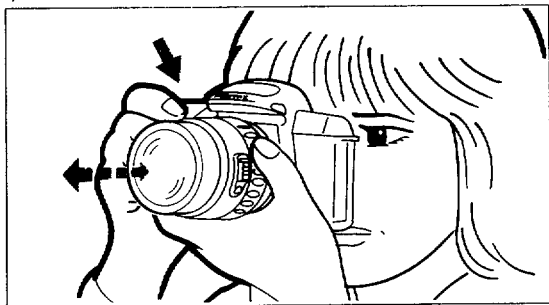

4. Pressing the shutter release button halfway down enables zooming so that the size of a subject stays constant with different camera-to-subject distances.

- * Predictive autofocus function (page 17) cannot be used in the Image Size Tracking mode. So, this function is not recommended for fast moving objects.
- * Pressing the shutter release button while zooming may not successfully achieve the specified image size; be sure to press the shutter release button only after the zooming is completed.
- * If the camera-to-subject distance is too close or too far, you cannot obtain the specified image size because it is out of the range of focal length of the zoom lens. In addition, since the image size stored in memory works on the lens currently in use, you may not obtain the specified image size if the lens is replaced with another.
- * Changing the focus-mode switch from [AF] to [MF] in the Image Size Tracking mode sets the camera to the Zoom Clip mode.
- * The contents of memory will not be lost even if the main switch is turned off.
- * Removing or exchanging a lens with the main switch turned on will cause the loss of memory; if you want to keep the contents of memory, turn off the switch first.
- * If you store another image size value into memory, the previous value will be lost.

Note:

Removal of the battery will cause the loss of memory.



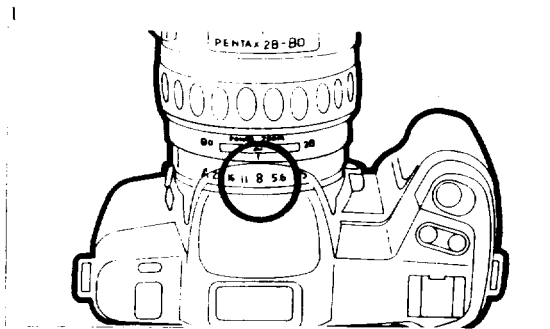

This function allows you to adjust the shutter speed and aperture.

Use this function if you wish to set one exposure setting regardless of the lighting conditions or if you wish to manually select your exposure settings.

With Metered Manual mode, only spot metering can be used. All light information is excluded from anywhere but the center portion of the frame. When adjusting the exposure setting, be sure that the subject falls within the center of the viewfinder.

1. Turn the aperture ring from the "A" position and set the lens at the desired f stop.

* To release the "A" lock, turn the aperture ring while pressing the aperture A lock button.

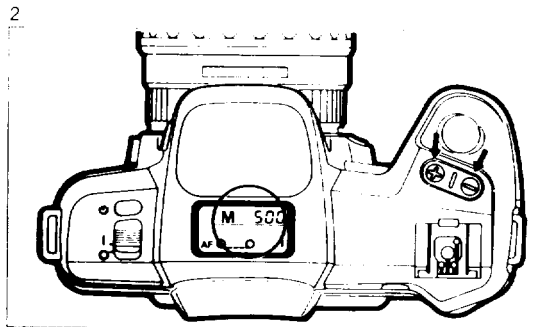

* The [M] indicator and shutter speed appear on the LCD panel.

2. Select the shutter speed.

For a fast shutter speed, press the white + button. For a slow shutter speed, press the Black - button.

* Each time you press the button, the speed goes up or down incrementally. Holding either button down continuously changes the shutter speed in fast motion.

3

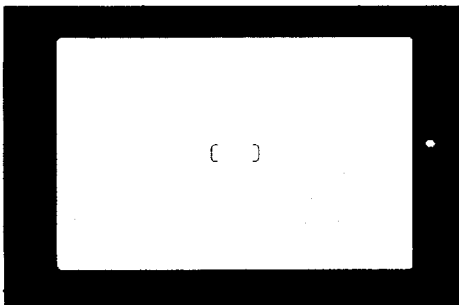

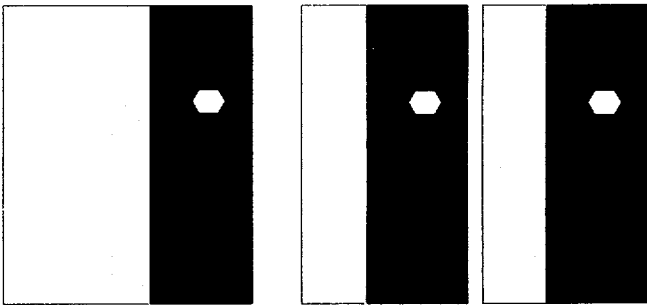

4



3. Position the subject in the center of the viewfinder.

- * Spot metering measures the light readings only in the central section of the viewfinder. This reading may result in a significant discrepancy between the exposure in the center and exposure in the rest of the image unless you determine the exposure considering the brightness in the whole viewfinder.

4. Press the shutter release button lightly, and [+], [-], or [] exposure indication appears in the viewfinder. [+] means overexposure, [] means correct exposure, and [-] means underexposure. By setting the aperture with the aperture ring and adjusting the shutter speed with the White [+] button or Black [-] button, you can determine the setting for your camera.

Exposure Warning:

The exposure indicators in the viewfinder blinks as a warning when a subject is too bright or too dark, or when the proper combination of the shutter speed and aperture is not selected. As long as the indicators are blinking, proper exposure cannot be obtained. If [+] is blinking, set the aperture ring to a smaller sized f-stop. If [-] is blinking, set the aperture ring to a larger sized f-stop. To set the proper exposure, adjust the aperture and shutter speed until the display stops blinking and you get the [] indication in the viewfinder. Use an ND filter if the [+] indicator does not stop blinking or a flash if the [-] indicator does not stop blinking even after the aperture has been adjusted.

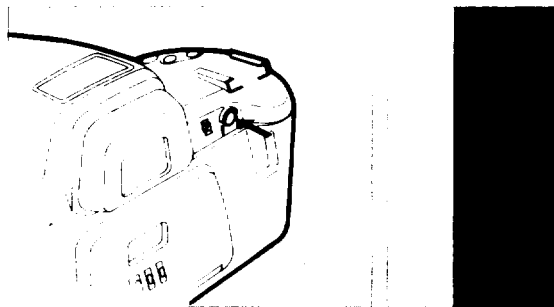

Hyper Manual Mode

Hyper Manual is a convenient manual exposure mode that enables you to obtain the correct exposure level with a press of a button.

The Hyper-Manual mode allows you to work in the full manual mode, setting both aperture and shutter speed, then with the press of the Hyper button you are switched from the full manual mode to an automatic mode which is similar to the aperture priority exposure mode.

When you press the Hyper button, the shutter speed is automatically selected by the camera based on the aperture you manually selected.

Proper speed and exposure is selected, you will see the [] exposure indicator in the viewfinder.

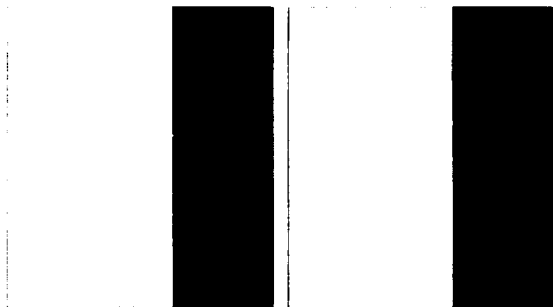

If you adjust the picture framing, the exposure indicator may change to [+] or [-]. To set the exposure for the new scene, singly press the Hyper button again.

If the [+] or [-] exposure indicator blinks after pushing the Hyper button, the camera can not set the proper exposure because the lighting conditions are out of the meter coupling range.

- * The [] indication appears in the LCD panel while the Hyper button is being pressed.

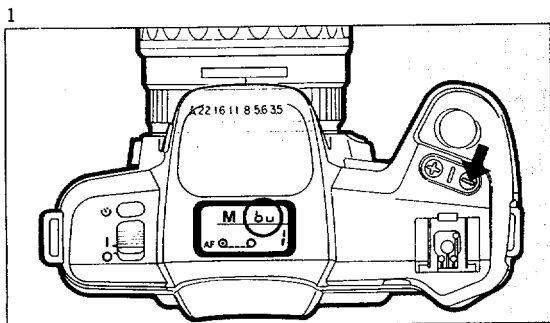

Use the bulb function for long-time exposure, such as fireworks and night scenes.

The shutter stays open as long as the shutter release button is held down.

1. Press the Black \ominus button in the Metered Manual mode until the [bL] indication appears in the LCD panel.

* In the bulb mode, no exposure indications appear in the viewfinder.

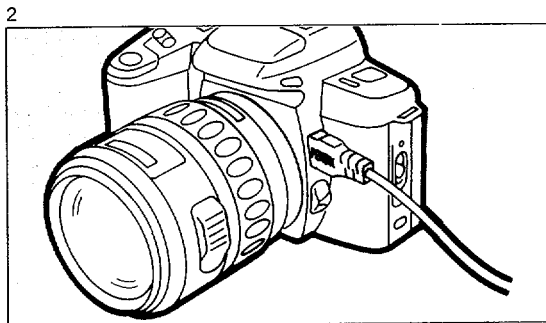

2. Use a solid tripod and connect the optional Cable Switch F for firing the shutter without vibrating the camera.

* With one fresh 6 V lithium battery, a long-time exposure of approximately 12 hours is possible under normal temperature.

8



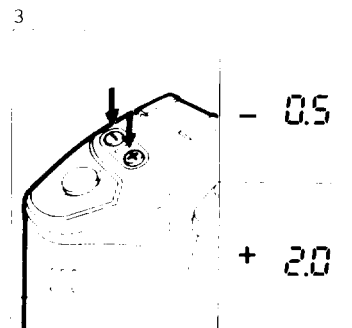
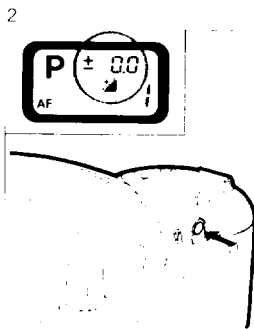
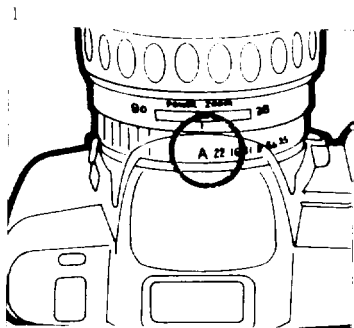

EXPOSURE COMPENSATION IN PROGRAMMED AE MODE



The exposure compensation system is used to change the basic exposure value or to intentionally under- or overexpose the subject in the AE mode.

1. Set the camera to the Programmed AE mode. (Set aperture to the A position).
2. Press the Hyper button. The [± 0.0] and [] indicators appear in the LCD panel.
3. Press the White + button or Black - button to select the desired exposure compensation. The selected exposure compensation value appears in the LCD panel.

- * Lightly pressing the shutter release button shows the [+] or [-] indication in the viewfinder.
- * The exposure compensation range is from -3.0 to 3.0 EV with 0.5 step increments.
- * To return to the normal Programmed AE mode, press the Hyper button again. The override setting disappears.
- * When shooting with the Pentax dedicated TTL flash unit, the exposure compensation system functions.
- * You can also clear the exposure compensation by turning off the Main Switch.

Viewfinder	Remarks
 **1	In the Metered Manual mode, the aperture is set to a brighter aperture or the subject is too bright.
 **2	In the Metered Manual mode, the aperture is set to a darker aperture or the subject is too dark.
 **3	In the Programmed AE mode, the subject is too bright or too dark.
	In the Programmed AE mode, a flash is necessary, or the lens in use is not appropriate for adequate flash coverage.
	Battery warning.

† All the LEDs being displayed blink.

- * The warnings are indicated by a blinking light.
- * The (.....) means a blinking indicator.

Correction to stop the blinking displays

**1 Decrease the aperture by setting it to higher numbers or adjust the shutter to a faster speed to stop the display from blinking.

If the display does not stop blinking, use an ND (Neutral Density) filter (a filter that reduces the amount of light).

**2 Increase the aperture by setting it to lower numbers or adjust the shutter to a slower speed to stop the display from blinking.

If the display does not stop blinking, use a flash or other lighting equipment.

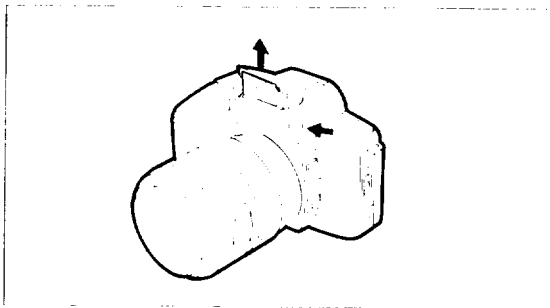
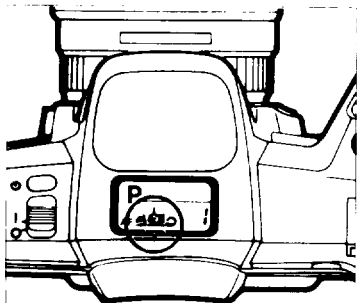

**3 If the subject is too bright, use an ND filter. If the subject is too dark, use a flash.



1 Daylight Synchronization function



ADDITIONAL FUNCTIONS

This function is useful in backlit scenes in which exposure compensation is required to brighten a subject. The Multi6-segment metering function automatically reads the lighting conditions for overall exposure balance.

The [] indication on the LCD panel and the [] indication in the viewfinder will start blinking if the metering system recommends daylight synchronization for a more balanced exposure. [Applicable only in the Programmed AE mode.]

Push the [] button to pop-up the flash unit from the camera body.

It is possible to take pictures with overall well balanced exposure because the built-in flash works as a Programmed TTL Auto flash.

- * The [] indicator on the LCD panel and the [] indication in the viewfinder may not blink even in the backlight condition when the subject is not centered. Use the built in flash to cope with this situation.
- * A subject may be shadowy even in normal lighting situations. Use the built in flash to compensate for the under exposure.

(2) Using the Flash in the Metered Manual mode

To determine the flash range for the subject you are photographing, set the lens to the manual lens apertures and apply the following formulas.

** GN = Guide Number

Maximum flash distance = $GN \div \text{Aperture you selected}$

Minimum flash distance = $\text{Maximum flash distance} \div 5$

If you already know the focus distance, use the following formula to determine the aperture.

$GN/\text{Focus distance} = \text{aperture}$

If the calculated aperture number doesn't exist on your lens aperture ring, use the next smallest aperture number.

The table below shows the equivalent guide number for various film speed.

ISO film speed	Guide number
ISO 25	GN 6
ISO 50	GN 8.5
ISO 100	GN 12
ISO 200	GN 17
ISO 400	GN 24

The following is an example using ISO100 film and a f/3.5 aperture setting.

1. Calculate the distance of the flash.
 $GN12 \div f/3.5 = 3.4\text{m}$
 $3.4 \div 5 = 0.68\text{m}$
2. In this example, you can take a picture using the flash at a distance ranging from 0.7m to 3.4m.

Note:

When shooting an object that is close and another that is further away in the same picture, setting the aperture for the object that is further away causes the closer object to be overexposed.

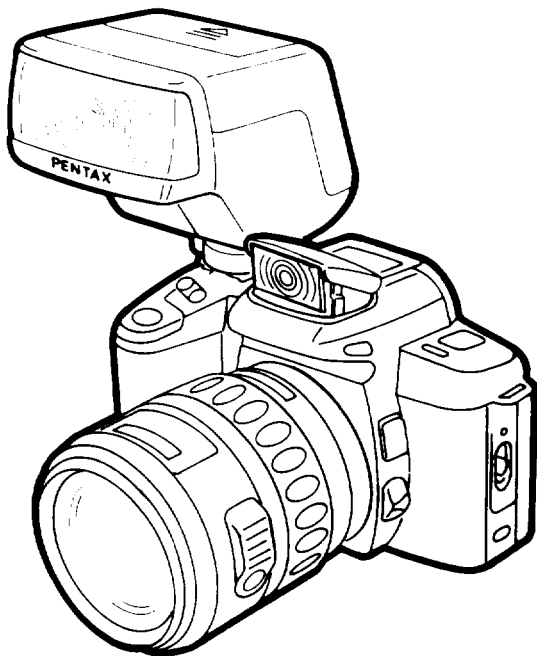

In situations where the built-in flash is not sufficient, such as large gatherings, use a Pentax dedicated flash.

1 Using the TTL Auto mode flash function

1. Remove the hot shoe cover and attach the Pentax dedicated flash unit.
2. Set the flash mode to the TTL Auto position. Set the camera to the Programmed AE mode.
3. Turn on the flash power switch.
4. To confirm that the flash has been charged, lightly press the shutter release button. When the flash ready lamp lights up, the [] indicator in the viewfinder turns on.
- * After charging, the shutter speed changes to 1/100 automatically.
5. Focus and shoot.
- * Slow speed sync flash is possible if the camera is set to the Metered Manual mode.

2: Overview of flash functions

Camera functions	TYPE A	TYPE B	TYPE C	TYPE D	TYPE E
After charging, the camera changes automatically to the flash's sync speed.	○	○	○	○	○
The aperture is adjusted automatically in the Programmed AE mode.	○	○	○	○	Note 1
Flash confirmation in the viewfinder.		○	○	Note 2	
TTL Auto flash mode.	○	○	○	○	
Slow speed synchronization in the Metered Manual mode	○	○	○	○	○
AF spotbeam		○	○		
Trailing curtain sync flash		○	○		
Contrast control mode		○			

Note 1:

With AF260S_A, AF240Z, AF200S_A and AF160S_A, the aperture is automatically set.

Note 2:

With only AF140C, the auto flash confirmation signal appears in the viewfinder.

When using older flash types "AF140", "AF160", and "AF200S", adjust the aperture as displayed on the flash calculation panel on the rear of the flash unit. The aperture and shutter speed are adjusted automatically in the Programmed AE mode when using the AF260S_A, AF240Z, AF200S_A or AF160S_A.

Warning:

Use of flash units made by other manufacturers may damage the circuitry of your camera.

- TYPE A : Built-in flash
- TYPE B : AF330FTZ
- TYPE C : AF400FTZ, AF240FT
- TYPE D : AF400T, AF280T, AF200T, AF140C, AF080C
- TYPE E : AF260S_A, AF240Z, AF200S_A, AF200S, AF160S_A, AF160, AF140

AF330FTZ

- * The flash mode switches to the Programmed TTL Auto mode when used with this camera (Refer to p.49). Daylight sync flash is possible because the aperture adjusts automatically according to subject brightness.
- * The flash unit automatically projects an AF spotbeam for dark and hard-to-autofocus subjects to assist the camera's autofocus system.
- * Incorporating a coupled auto zoom mechanism, this flash automatically changes the illumination angle according to the focal length of the lens.
- * You can use the Contrast Control mode [Refer to the instruction manual for your flash.]
- * Even when using the flash unit in manual mode, its mode switches automatically to the Programmed TTL Auto mode if the camera is in the Programmed AE mode.
- * The flash power automatically turns off if it is left unused about three minutes after charging. To charge again, press the shutter release button halfway down.

AF240FT, AF400FTZ

- * The flash mode switches to the Programmed TTL Auto mode when used with this camera (Refer to p.49). Daylight sync flash is possible because the aperture adjusts automatically according to the subject brightness.
- * Even when using the flash unit in manual mode, its mode switches automatically to the Programmed TTL Auto mode if the camera is set to the Programmed AE mode.
- * The flash power automatically turns off if it is left unused about five minutes after charging. To charge again, press the shutter release button halfway down.
- * The flash unit automatically projects an AF spotbeam for dark and hard-to-autofocus subjects to assist the camera's autofocus system.

AF200T, AF280T, AF400T

- * The flash mode switches to the TTL Auto mode when used with this camera. It is not recommended to use the daylight sync mode because the aperture is automatically set at f/4 [At ISO 100].
- * When using Two-Level Auto or Three-Level Auto (red, green, or yellow settings), the aperture changes as shown in the table. After charging, the shutter speed changes to 1/100.

(at ISO 100)

	AF400T	AF280T	AF200T
Red	f/4	f/4	f/2.8
Green	f/8	f/8	f/5.6
Yellow	f/11	—	—

(AF200S_A: f/4 at ISO 100)

TTL Auto Flash :

TTL auto flash is an exposure control function that calculates and controls the output of the flash according to the amount of light that comes to the film plane back through the lens. It is an accurate exposure control that measures only reflected light from the subject.

[You can use TTL Auto flash with AF330FTZ, AF400FTZ, AF400T, AF280T, AF240FT, AF200T]

Programmed TTL Auto Flash:

Calculates the amount of light reaching the film and controls flash output based on a program which automatically selects aperture and shutter speed. Programmed TTL Auto Flash also allows daylight synchronization.

[You can use Programmed TTL Auto Flash with the built-in flash or the AF400FTZ, AF330FTZ, AF240FT]

Slow-speed synchronization:

Ordinary flash synchronization does not allow for the proper exposure of the low light background, as the shutter speed is too fast. Slow speed sync allows the flash to properly expose the subject. The shutter stays open to properly expose the low light background.

(3) Precaution for Using Pentax Dedicated Flash Units

1) When using type D flash in the MS [Manual Synchro] or M [Manual] mode, adjust the aperture as determined by the flash calculation panel on the rear of flash unit. (TYPE D flash).

You cannot obtain proper exposure if the camera is set to the Programmed AE mode.

2) When using a Pentax dedicated flash in addition to the built-in flash, the dedicated external flash has priority function control over the built-in flash. Be sure that all flashes have been charged.

3) Using the optional "Hot Shoe Adapter F" makes it easier to mount the "AF080C Ring Light Control Pack" onto the hot shoe.

Functions	Lens(Mount) *1				
	FA Lens	F Lens	A Lens	M Lens	S Lens
Auto Focus : Lens alone			×	×	×
With AF Adapter 1.7x	—	—	*3	*3	×
Manual Focus : FI System *2	*4	*4	*4	*4	×
Matte Screen					
Power Zoom	*5	×	×	×	×
Zoom Clip Mode	*5	×	×	×	×
Image Size Tracking Mode	*5	×	×	×	×
Programmed AE Mode				×	×
Metered Manual Mode					
Programmed TTL Auto Flash Mode				×	×
TTL Auto Flash Mode					
Manual Flash Mode					

Note 1:

For more details about lens mounts, refer to inside cover.

Note 2:

Manual focusing based on the [\square] indicators in the viewfinder [FI=Focus Indicator]

Note 3:

For lenses with maximum aperture of 2.8 or brighter.
[See Instruction manual for AF Adapter for details]

Note 4:

For lenses with maximum aperture of 5.6 or brighter.

Note 5:

For Pentax FA zoom lenses only.

The "Snap-in-Focus" can be used in combination with a Pentax K_a or K-mount lens. Set the focus mode switch to [AF]. Adjust the focus manually at the point you expect to capture the subject and hold the shutter release button all the way down. The shutter will release automatically as soon as the subject moves into the prefocused area.
(Cable Switch F can be used.)

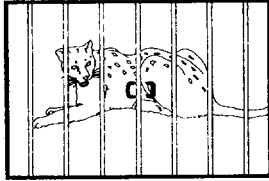
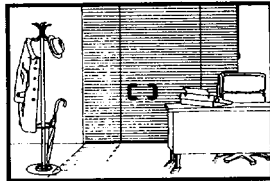
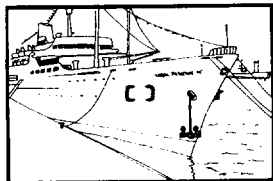

Autofocus is an exceptionally high-performance mechanism, but it is not perfect. Depending on the subject brightness, contrast, shape, and size, the focus may not work as in the case of focusing using the [\square] of the viewfinder. Use the focus-lock technique on a subject which is both near the actual one and at an equal distance from the camera or use the matte area in the viewfinder for focusing.

Factors that Make Autofocusing Difficult

- 1) Extremely low contrast subjects such as white walls in the AF frame.
- 2) Subjects which don't reflect much light in the AF frame.
- 3) Subjects which are moving too fast.
- 4) Subjects with horizontal lines or with finely detailed patterns in the AF frame.
- 5) Multiple subjects in the foreground and background of the AF frame.
- 6) Subjects positioned against reflected light, strong backlight or on extremely bright background.

Note:

For the situations mentioned above, set focus mode lever to [MF] and focus manually using the matte focusing area surrounding the AF frame.

Warnings About Accessories...

The following conditions do not allow autofocusing or manual focusing using the FI (Focus Indication) system in the viewfinder. Focus manually using the matte focusing area surrounding the AF frame. (See page 53.)

- 1) When using special effects filters or "Magic Image Attachment" or "Stereo Adapters."
- 2) A half mirror incorporated into the autofocus system reduces the effectiveness of the autofocus when used with an ordinary polarizing filter. Use a circular polarizing filter with autofocus.
- 3) When using Extension Tubes or an Auto Bellows.

Note on using the SMC Pentax F Soft 85mm f/2.8

When shooting at a distance less than approx. 1.5m, set the lens to f/2.8 to f/4.5. If you set the aperture to f/5.6 ~ f/32, camera's autofocus function as well as the focus-indication in the viewfinder may not operate properly. When you want to set the aperture to an f/5.6 or darker, first set the lens to an f/4.5, focus the lens on the subject, lock focus, and then set the aperture as desired to take a picture.

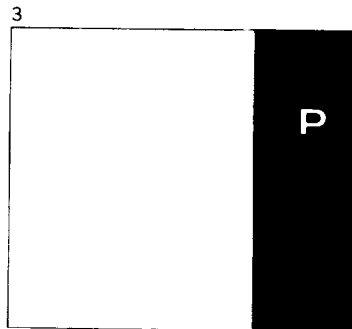
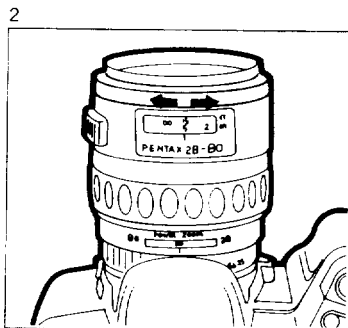
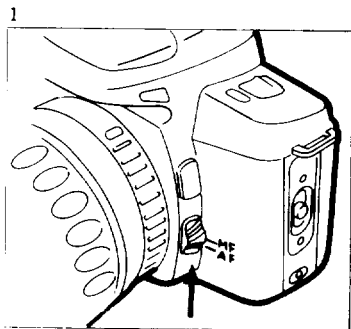

When using older K_A- or K-mount lenses with a maximum aperture of f/5.6 or brighter, you can manually adjust the focus based on the FI (Focus Indication) system in the viewfinder. An electronic beep signals that the subject is in focus.

- * K_{AF}- and K_{AF2}-mount lenses set at [MF] operate the same way.
- * Screw mount lenses mounted on the camera with the optional "Mount Adapter K" cannot be focused utilizing the FI (Focus Indication) system in the viewfinder.

1. Set the focus mode lever to the [MF] position.
 2. While looking through the viewfinder, lightly press the shutter release button and turn the focusing ring of the lens to the left or right.
 3. When you obtain proper focus, the [○] indicator in the viewfinder turns on. To take a picture, press the shutter release button.
- * A short beeping sound will be heard when proper focus is obtained.

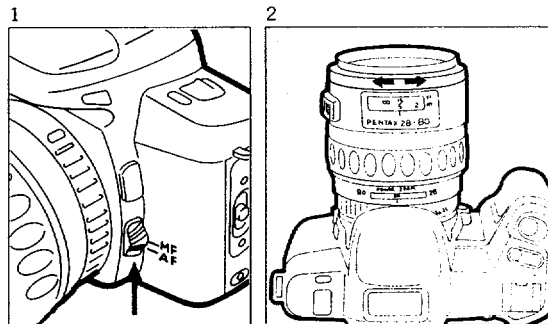
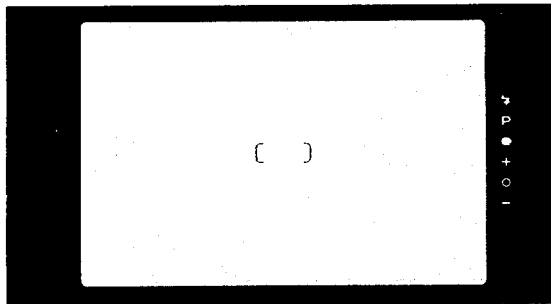

The following situations do not allow manual focus adjustment using the FI (Focus Indication) system in the viewfinder. Manually adjust the focus using the matte area of the viewfinder.

- 1) When the [] indicator does not confirm focus for hard-to-autofocus subjects.
- 2) When a lens with maximum aperture smaller than f/5.6 is used.
- 3) Bellows 100mm f/4, shift 28mm f/3.5 (shift position), reflex lens.
- 4) Screw mount lens with "Mount Adapter K" attachment.

1. Set the focus mode lever to [MF].
2. While looking through the viewfinder, turn the focusing ring of the lens to the right or left. Adjust the focus until the image comes clear on the screen.

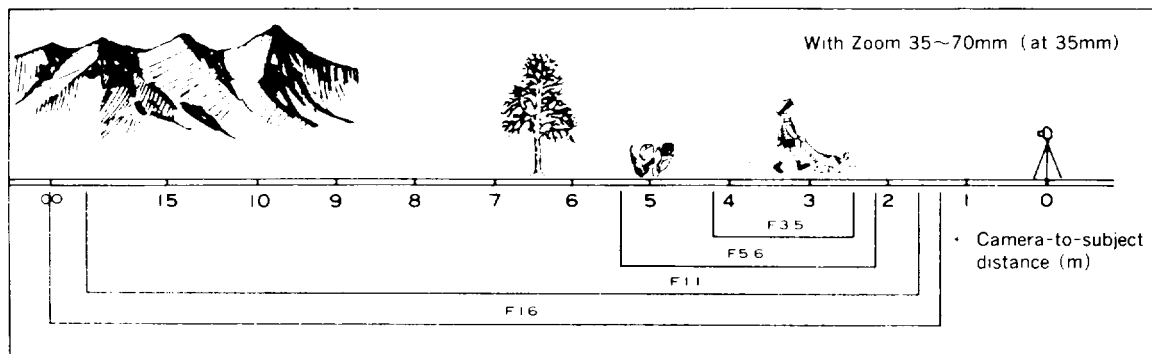

Depth of field refers to the range around the optimum focusing point of the subject in which the elements at different distances are in focus.

The range allowed for focusing

The depth of field increases as the aperture becomes smaller, as the focal length of the lens becomes shorter, and as the subject is positioned farther away. By changing apertures, you can control the depth of field and create different visual effects.

* Some zoom lenses do not have a depth-of-field scale due to mechanical reasons.



Aperture set at $f/4$



Aperture set at $f/22$

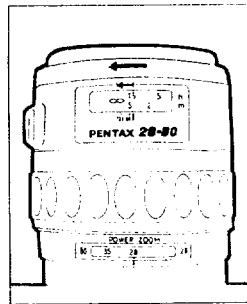
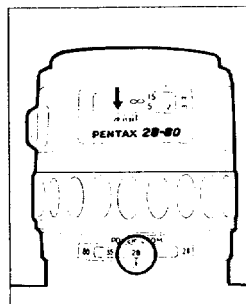

When taking pictures with infrared film and an "R2" or "O2" filter, it is necessary to adjust the focus because the point of focus is not the same with infrared light as it is with visible light. Autofocus cannot adjust the focus for infrared pictures. Once the camera adjusts the focus, set the focus mode lever to [MF]. Next, memorize the focus point on the lens distance scale and turn the focusing ring so the point you memorized aligns with the infrared index.

As shown in the figure, if the focal length scale is set at 28, adjust the distance scale to 28 on the infrared index.

- * Refer to your film guide for setting the exposure for infrared pictures. The optimum exposure cannot be achieved in the Programmed AE mode. Instead, set the exposure in the Metered Manual mode.

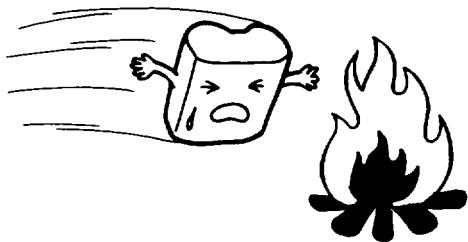

- * Use one lithium "2CR5" battery.
- * Use battery properly. Improper use may cause the battery to overheat which may result in rupture and chemical seepage. Be sure to check the polarities before inserting the battery.
- * Disassembling, damaging, charging, or heating battery may cause battery to rupture.
- * Low temperatures may decrease battery performance but the battery will return to normal performance at normal temperature.
- * When traveling or shooting outdoors, carry an extra supply of batteries.

- * When storing the camera in a bag or a case, make sure the main switch is turned off, to avoid accidental shutter release and unnecessary battery consumption.
- * When the built-in flash is used continuously, the battery may become warm, but it does not mean the battery is faulty; it is one of the battery's characteristics.

Battery life

General Photography		Approx. 120 rolls
Flash Photography	50% flash usage time	Approx. 40 rolls
	100% flash usage time	Approx. 20 rolls
Bulb exposure time		Approx. 12 hours

According to Pentax testing conditions
 Applicable to the use of a fresh lithium battery [2CR5],
 24 - frame film, room temperature.

Special accessories (optional)

● Cable switch F

Shutter release cord for this camera and SFX_N/SF1_N and SF7/SF10 models.

● Magnifier F_B

An accessory for close-up. It magnifies the viewfinder image.

● Flash AF330FTZ

Built-in auto zoom flash with AF spotbeam, guide number 33. Contrast Control Flash mode, leading and trailing curtain flash synchronization.

● Flash AF240FT, AF400FTZ

Auto flash with AF spotbeam, guide number 24 for AF240FT and guide number 40 for AF400FTZ.

AF400FTZ also incorporates a zoom flash head.

Leading and trailing curtain flash synchronization.

● Hot shoe adapter F, 5P sync cord F

Adapter and cord which allow separation of the AF240FT, AF330FTZ, and AF400FTZ from the camera.

● AF adapter 1.7X

Adapter for autofocus photography with a K_A- or K-mount lens with a maximum aperture of f/2.8 or brighter.

Warning About Accessories :

● With Auto Bellows A, you can not use the double cable release. Also place the grip side of the camera up when shooting in a vertical position.



● When vertically positioning a camera using the tripod connector of a PENTAX F300mm F4.5ED (IF) lens, and the grip side is facing upward, the lock screw of the lens hits against the camera. To avoid hitting the camera, face the grip side down.

● When attaching a 645 lens adapter K, the fixing screw may hit against the camera body. To avoid this, change the position of the screw.

● When attaching a PENTAX M reflex 2000mm F13.5 lens to the camera, the vertical-horizontal converter lock screw of the lens may hit against the camera body. To avoid accidents, change the position of the lock screw.

● When attaching an AF280T, AF200T, AF240Z, or AF200S_A flash to the hot shoe of the camera, you may not be able to access the black  button.

Refer to the problems and solutions listed below before calling customer support.

Symptoms	Causes	Remedies	Reference
Shutter does not release.	The Main Switch is not on.	Turn on the Main Switch.	p.7
	The battery warning [] indication appears.	Replace the battery.	p.7
	The battery is not inserted properly.	Re-insert the battery properly.	p.6
	The camera is in the self-timer mode.	Clear the self timer mode.	p.29
	Built-in flash is charging.	Wait until charging is complete.	p.20
Indicators do not appear on the LCD panel.	The Main Switch is not on.	Turn on the Main Switch.	p.7
	The battery has not been inserted.	Insert battery.	p.6
	The battery is not inserted properly.	Re-insert the battery properly.	p.6
	The battery is dead.	Replace the battery.	p.7
The camera cannot focus the subject.	AF frame is not placed on the subject.	Place the subject into the AF frame before taking a picture.	p.16
	Camera is too close to the subject.	Move the camera farther away from the subject.	p.16
	The zoom lens is in the macro setting.	Get out of the macro setting or adjust the position of the camera by moving closer or farther from the subject.	
	The camera is in the [MF] manual focus mode.	Set the camera to the [AF] autofocus setting.	p.15
	The subject is difficult to autofocus.	Use the focus-lock technique on a subject which is both near the actual one and at an equal distance from the camera, or use the matte area in the viewfinder for focusing.	p.30 p.53
The LED indicator in the viewfinder blinks.	Battery is low.	Replace the battery.	p.7
The [] indicator in the viewfinder is blinking.	The camera is too close to the subject or a subject that is difficult to autofocus cannot be focused.	Use the focus-lock technique or focus using the matte area.	p.30 p.53

Symptoms	Causes	Remedies	Reference
Built-in flash does not charge.	The battery is dead.	Replace the battery.	p.7
The [] indicator in the viewfinder is blinking in the Programmed AE mode.	The subject is too dark or when shooting a backlit subject.	Use of flash is recommended.	p.19
The [+], [-], or [P] indicator in the viewfinder is blinking.	The subject is too bright or too dark during Programmed AE or Metered Manual mode. The aperture is not set correctly in the Metered Manual mode.	If the subject is too bright or too dark, use an ND filter or flash. If the aperture is set incorrectly in the Metered Manual mode, adjust the aperture.	p.43
Zoom Clip mode can not be set.	The lens is set at manual zoom. The auto zoom switch of the lens is set at [P].	Push the power zoom ring of the lens out forward until [POWER ZOOM] appears. Set the auto zoom switch of the lens to [A].	p.31 p.32
The Image Size Tracking mode can not be set.	The focus-mode switch of the camera is in the [MF] manual focus setting. The lens is set at manual zoom. The auto zoom switch of the lens is set at [P].	Set the focus-mode switch of the camera at [AF] autofocus setting. Push the power zoom ring of the lens out forward until [POWER ZOOM] appears. Set the auto zoom switch of the lens to [A].	p.31 p.37
The power zoom does not work.	The lens is set at manual zoom.	Push the power zoom ring of the lens out forward until [POWER ZOOM] appears.	p.24
	The built-in flash is being charged.	Wait until charging is completed.	p.24
While shooting, the zooming automatically operates.	The camera is in the Image Size Tracking mode.	Clear the Image Size Tracking mode.	

TAKING CARE OF YOUR CAMERA

Your Pentax camera is a sophisticated, precision instrument built to give long lasting, reliable service. It will serve you well if you treat it right, with proper handling and reasonable care. The major causes of damage are:

1. Dropping or banging the camera against immovable objects, which can damage the camera in many ways.
2. Water damage, particularly if the camera is submerged in salt water. Your camera is not water-proof! It must be protected from salt breeze, salt spray at the beach, splashing liquid of any kind, and shielded from the rain. If your camera does get soaked, wipe it dry immediately and rush it to a Pentax service center.

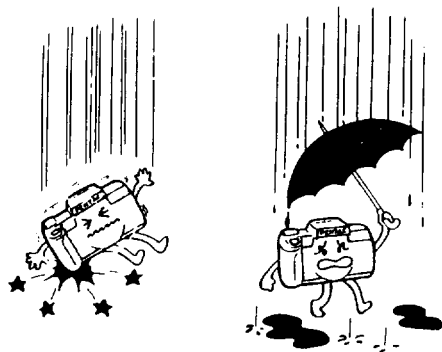

3. Dirt and sand can cause serious damage to the shutter and other moving parts of the camera. Your camera needs periodic cleaning to keep it operating properly. To remove dirt and dust, you need lens-cleaning fluid, lens-cleaning tissues, bulb-type ear syringe, camel's hair-brush, etc. Never use a solvent such as paint thinner or alcohol.
4. Humidity and temperature extremes should be avoided. Keep your camera out of direct sunlight, car trunks, and glove compartments. Shooting outdoors in winter presents a problem since batteries won't function if they get too cold. In cold weather carry your camera under your coat or jacket to keep the batteries warm. The temperatures at which this camera should function properly are approx. 50 ~ -10 C.



Sudden changes in temperature will often cause moisture to condense inside, or outside your camera. This is a possible source of rust, which may be extremely harmful to the mechanism.

Furthermore, if the camera is taken from a warm temperature to a sub-freezing one, further damage may result from the formation of icelets.

Thus, sudden temperature changes should be avoided as much as possible. As a guide, a temperature change of 10° C should be allowed to take place gradually over a period of at least 30 minutes.

If this is not possible, keeping the camera in its case or bag will help somewhat in minimizing the effects of a rapid temperature change.

5. Vibration experienced when you are traveling in a car, plane, or ship, can cause screws to loosen.
To minimize this problem use foam-rubber padding about one inch thick to line the bottom of your camera bag.
6. When mounting your camera on a tripod, make sure the tripod screw is no longer than 5.5mm, which is the depth of your camera's tripod socket. If you use a longer screw, you will possibly puncture the tripod socket, after which the camera will not function properly.

Precautions on LCD Display

- In temperatures over approximately 60°C, the LCD display may darken.
It will return to its normal condition under normal temperature.
- In low temperatures, the LCD display may respond more slowly. This is due to the characteristics of the liquid used and is not a malfunction.

Backup Circuit for LCD Display

Even when the battery is removed for replacement during shooting, the built-in backup circuit retain data such as the frame number and the ISO film speed in memory until a new battery is inserted.

SPECIFICATIONS

Type:	TTL AE/AF35mm SLR with built-in TTL auto flash.
Format:	24 × 36mm.
Film:	35mm cartridge film. DX-coded film with ISO 25-5000; non-DX coded films are set to ISO 100.
Exposure modes:	Programmed AE and Metered Manual.
Shutter:	Electronically controlled vertical-run focal-plane shutter. Programmed AE from 1/2000 to 30 sec. (stepless) and Metered Manual from 1/2000 to 1 sec., bulb. Electromagnetic release, shutter lock with Main Switch off.
Lens mount:	Pentax Bayonet K _{AF} -Mount (K-mount with AF coupler, lens information contacts and power contacts)
Lens:	K _{AF} - and K _{AF} -mount lens, K _A - and K-mount lens (autofocus is possible with AF adapter)
Focusing System:	Pentax TTL phase matching autofocus system. Usable illumination range: EV1 to EV18 (with f/1.4 lens at ISO100)
Power zoom:	3-speed power zoom, Zoom Clip Mode, Image Size Tracking Mode.
Viewfinder:	Penta-mirror finder, Aspheric-micro matte focusing screen. Field of view: 91%, magnification: 0.77 × (50mm, ∞), -1 diopter eyepiece.
Viewfinder LED indication:	Focus information: in-focus (green lamp is lit), front focus and back focus signals and unable-to-focus indicator (green lamp blinks). Exposure information: programmed AE: [P] display, out-of-metering range: [P] blinking, Exposure compensation: [+], [-] display, Metered Manual mode: [+], [-] display, [+] is overexposure, [-] is correct exposure, [-] is under-exposure, out-of-metering range: [+], [-] blinking, Flash charge completion, flash-recommended display or inappropriate lens warning: blinking.
External LCD indication:	Focus mode, exposure mode, shutter speed, flash recommendation, low-light warning, charge completion, inappropriate lens warning, exposure counter, film loading/winding/rewinding, film loading error, self timer, low battery warning, exposure compensation indication, Zoom Clip and Image Size Tracking Mode.
Self-timer:	Electronically controlled type with delay time of approx. 12 sec. Start by shutter release button. Cancellation after activation is possible. Operation confirmation by beeping sound.
Mirror:	Swing-up-type instant-return with AF secondary mirror.
Film loading:	Auto loading, Closing the back cover will automatically wind film to first frame.

Film advance/rewind:	Automatic winding/rewinding, auto rewinding starts at end of roll. Auto stop upon completion of rewinding. Rewinding time : approx. 15 sec. with 24-exposure film. Film rewinding/completion of rewinding displayed by LCD. Auxiliary rewind button will rewind film in mid-roll.
Exposure control:	TTL multi(6)-segment metering by SPD cell. Metering range from EV1 to EV21 at ISO100 with 50mm f/1.4 lens. Spot metering in Metered Manual Mode.
Built-in flash:	Retractable TTL Auto Flash (RTF), Guide number : 12 (ISO 100 in meters). Covers angle of view for 35mm wide-angle lens. Sync speed : automatically switches to 1/100 sec., Daylight sync flash, slow speed sync flash in Metered Manual Mode.
Flash sync:	Via hot shoe with X-contact which couples with Pentax dedicated auto flash units.
Power source:	One 6V lithium battery (2CR5)
Back cover:	Interchangeable for accepting Data Back Fc
Dimensions:	146.0 (W) ×92.5 (H)×66.5(D) (5.7"×3.6"×2.6")
Weight:	490 grams (17.3 oz.) without battery

SPECIFICATIONS ARE SUBJECT TO CHANGE AT ANY TIME WITHOUT NOTIFICATION OR ANY OBLIGATION ON THE PART OF THE MANUFACTURER.

WARRANTY POLICY

All Pentax cameras purchased through authorized bona fide photographic distribution channels are guaranteed against defects in material or workmanship for a period of twelve months from date of purchase. Service will be rendered and defective parts will be replaced without cost to you within that period, provided the equipment has not shown evidence of impact, sand or liquid damage, mishandling, tampering, battery or chemical corrosion, operation contrary to operating instructions, or modification by an unauthorized repair shop. Because the tolerances, quality, and design compatibility of lenses other than Pentax lenses are beyond our control, damage caused by use of such lenses will not be covered by this warranty policy. The manufacturer or its authorized representatives shall not be liable for any repair or alterations except those made with its written consent and shall not be liable for damages from delay or loss of use or from other indirect or consequential damages of any kind, whether caused by defective material or workmanship or otherwise; and it is expressly agreed that the liability of the manufacturer or its representatives under all guarantees or warranties, whether expressed or implied, is strictly limited to the replacement of parts as herein before provided. No refunds will be made on repairs performed by non authorized Pentax service facilities.

Procedure During 12-month Warranty Period

Any Pentax which proves defective during the 12-month warranty period should be returned to the dealer from whom you purchased the equipment or to the manufacturer. If there is no representative of the manufacturer in your country, send the equipment to the manufacturer, with postage prepaid. In this case, it will take considerable length of time before the equipment can be returned to you owing to the complicated customs procedures required. If the equipment is covered by warranty repairs will be made and parts replaced free of charge, and the equipment will be returned to you upon completion of servicing. If the equipment is not covered by warranty, regular charges of the manufacturer or of its representatives will apply. Shipping charges are to be borne by the owner. If your Pentax was purchased outside of the country where you wish to have it serviced during the warranty period, regular handling and servicing fees may be charged by the manufacturer's representatives of that country. Notwithstanding this, your Pentax returned to the manufacturer will be

serviced free of charge according to this procedure and warranty policy. In any case, however, shipping charges and customs clearance fees are to be borne by the sender. To prove the date of your purchase when required, please keep the receipts or bills covering the purchase of your equipment for at least a year. Before sending your equipment for servicing, please make sure that you are sending it to the manufacturer's authorized representatives or their approved repair shops, unless you are sending directly to the manufacturer. Always obtain a quotation for the service charge, and only after you accept the quoted service charge, instruct the service station to proceed with the servicing.

This warranty policy does not apply to Pentax products purchased in the U.S.A., U.K., or Canada. The local warranty policies available from Pentax distributors in those countries supersede this warranty policy.

- Film chamber
- Rewind shaft
- Shutter curtain
- Eyecup Fc

- Viewfinder eyepiece
- Viewfinder-accessory groove
- Hyper button
- Film-information window
- Pressure plate
- Back cover

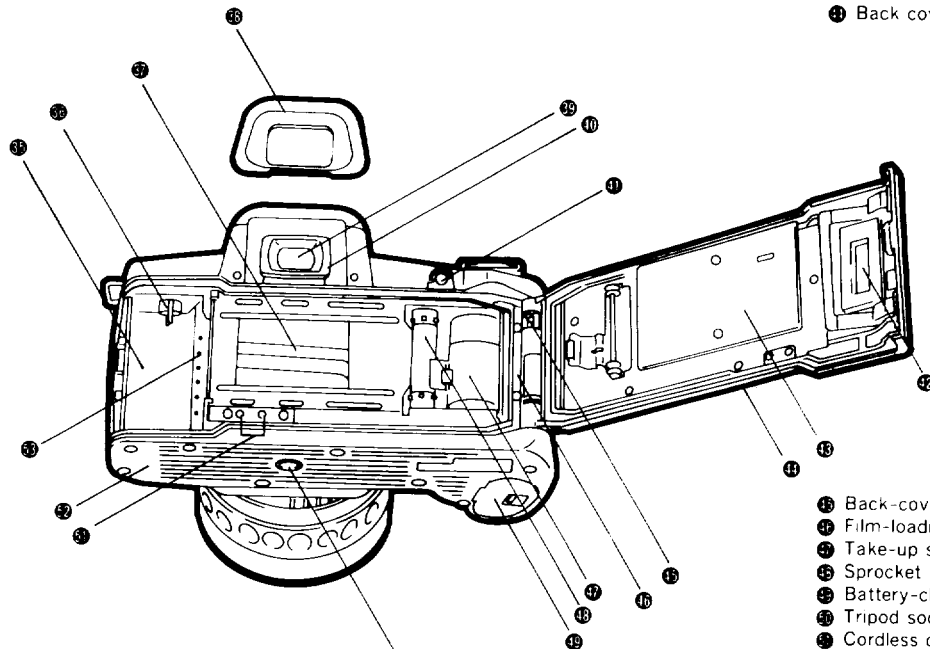

- Back-cover-release pin
- Film-loading mark
- Take-up spool
- Sprocket
- Battery-chamber cover
- Tripod socket
- Cordless contacts
- Bottom cover
- DX-information pins





Asahi Optical Co., Ltd. C.P.O. 895 Tokyo 100-91, JAPAN

Pentax Europe n.v. Weveldlaan 3-5, 1930 Zaventem, BELGIUM

Pentax Handelsgesellschaft mbH. Julius-Vosseler-Strasse, 104 2000 Hamburg 54 GERMANY

Pentax U.K. Limited. Pentax House, South Hill Avenue, South Harrow, Middlesex HA2 0LT U.K.

Pentax France Z I Argenteuil, 12, rue Ambroise Croizat, 95100 Argenteuil FRANCE

Pentax Nederland Spinveld 25, 4815 HR Breda, NETHERLANDS

Pentax (Schweiz) AG Industriestrasse 2, 8305 Dietlikon, SWITZERLAND

Pentax Scandinavia AB Falhgsgleden 57, 75127 Uppsala, SWEDEN

Pentax Corporation 35 Inverness Drive East, Englewood, Colorado 80112, U.S.A.

Pentax Canada Inc. 3131 Universal Drive, Mississauga, Ontario L4X 2E5, CANADA

Asahi Optical Brasileira Ind. e Com. Ltda. Rua Estados Unidos, 1053 São Paulo, BRASIL

Free Manuals Download Website

<http://myh66.com>

<http://usermanuals.us>

<http://www.somanuals.com>

<http://www.4manuals.cc>

<http://www.manual-lib.com>

<http://www.404manual.com>

<http://www.luxmanual.com>

<http://aubethermostatmanual.com>

Golf course search by state

<http://golfingnear.com>

Email search by domain

<http://emailbydomain.com>

Auto manuals search

<http://auto.somanuals.com>

TV manuals search

<http://tv.somanuals.com>