

PENTAX

**BINOCULARS
FERNGLÄSER
JUMELLES
BINOCOLI
PRISMÁTICOS
VERREKIJKERS**

**双筒望远镜
双筒望远镜**

**OWNER'S MANUAL
BEDIENUNGSANLEITUNG
MANUEL D'UTILISATION
ISTRUZIONI
MANUAL DE INSTRUCCIONES
HANDLEIDING**

使用説明書
使用説明書

FB-7
Lite

FB-9
Lite

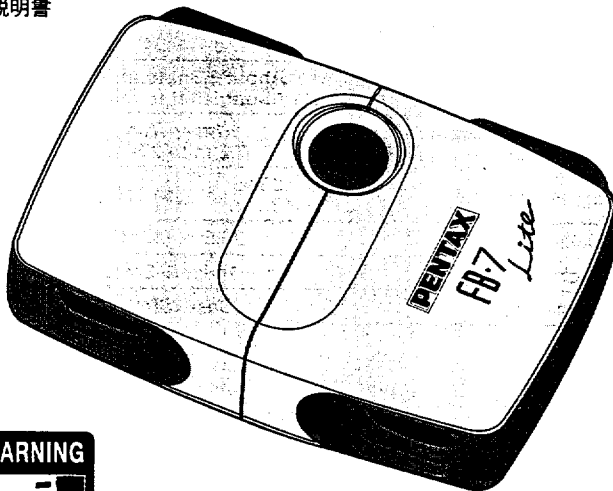

⚠ WARNINGS
Never attempt to look into the sun with binoculars.

English

Specifications

Models	FB-7 Lite	FB-9 Lite
Features		
Type	Roof prism, Center focusing, Linked operating lens barrels, Retractive eyepiece	
Magnification	7×	9×
Effective diameter of objective lens	17mm × 11mm	
Real field of view	7.1° (Diagonal direction)	5.6° (Diagonal direction)
Field of view at 1000m	124m	98m
Field of view at 1000yards	372ft. (Diagonal direction)	294ft. (Diagonal direction)
Exit pupil aperture	2.4mm × 1.6mm	1.9mm × 1.2mm
Relative brightness	4.5	2.7
Eye relief	11mm	8.5mm
Focusing range	About 1.8m to infinity About 5.9 ft to infinity	
Eye width (ocular distance) adjustable range	57mm to 70mm 2.2 in to 2.8 in	
Height & width	64mm × 95mm 2.5 in × 3.7 in	64mm × 95mm 2.5 in × 3.7 in
Thickness	26.5mm, (1.0in)	
Weight	148g, (5.2oz)	
Accessories	Case, Strap	

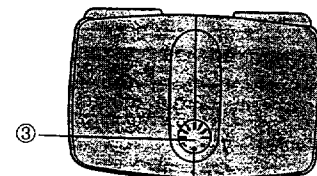
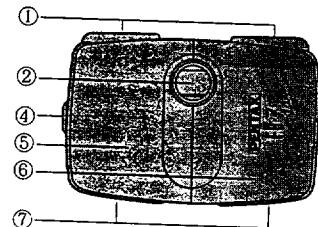

English Names of Parts

- ① Eyepiece Lenses
- ② Central Focusing Wheel
- ③ Diopter Adjusting Ring
- ④ Neck Strap Hook
- ⑤ Right Cover
- ⑥ Left Cover
- ⑦ Objective lenses

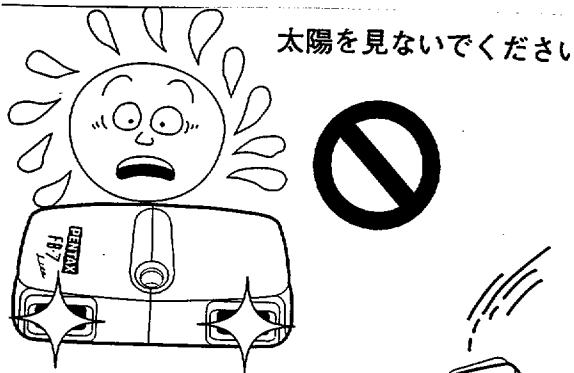

太陽を見ないでください

衝撃を与えないで
ください

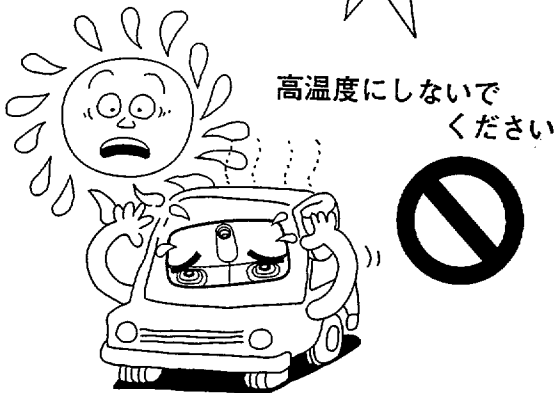
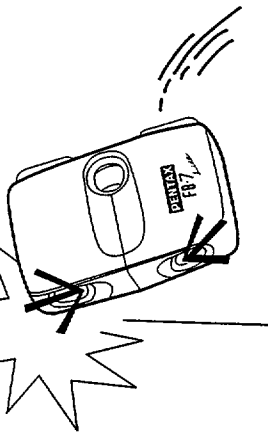

高温にしないで
ください



温度差のある場所では
注意してください



English

Features

Pentax FB Lite Series binoculars are high-performance binoculars that have been perfected making the best use of high optical technology and abundant experience. Their bodies are designed to be slim and compact, and, together with the new, easy-to-hold design, this makes them very convenient to carry. Adopting a focussing ring eyepiece housing mechanism and housing the eyepieces within the binocular barrels when not in use has reduced projections. Good focussing operation can easily be achieved with either hand because a left and right interlocked sliding system has been adopted for inter-ocular distance adjustment and the binocular barrels operate uniformly about the centre of the body. The field of view configuration is television screen size (4:3) and guarantees a stable and natural view.

▲ WARNINGS

1. To avoid serious eye damage, NEVER look at the sun using the binoculars. Serious damage to the retina, or total loss of eyesight may occur.
2. Do not leave the binoculars in direct sunlight. Sun rays passing through the binoculars will be intensified, and should they focus on flammable materials, fire may occur.

▲ Safety Precautions

1. Do not use the binoculars while walking as depth perception and peripheral vision are dramatically altered.
2. Caution should be taken when adjusting the binocular barrels to avoid fingers being pinched.
3. Using the binoculars continuously for a long time may cause inflammation of the skin around the eye where the eyepiece come in contact with the skin. Consult a physician if any symptoms are noticed.
4. Do not swing the binoculars by the neck strap.
5. Be careful with the vinyl bag. Keep the vinyl bag in which the binoculars are packed for delivery, and all other vinyl bags, out of the reach of children and infants, as there is a risk of suffocation.

Handling Precautions

1. Do not apply excessive force when adjusting the focusing wheel, diopter adjusting ring, or eyepiece width.
2. Do not drop the binoculars or subject them to strong vibration, impact or pressure.
3. Never expose the binoculars to high temperature (Over 60 degrees centigrade or 140 degrees Fahrenheit). Avoid leaving the binoculars for an extended period of time in a hot humid place such as in a car parked in the sun or near a heater, as this could cause the binoculars to become deformed.
4. Care should be taken when the binoculars are taken between two places with widely varying temperatures difference as condensation or, in extreme cases, icelets may form that could cause rust or other damage. In such circumstances the binoculars should be covered so that the temperature change will be as gradual as possible. After the temperatures have stabilized, the binoculars may be uncovered and used again.
5. Reasonable care should be taken to prevent exposure to dirt, mud, sand, moisture, toxic gas, water, salt water, or any other substance which may penetrate the inside of the binoculars, or the mechanisms. These substances may cause internal damage or render the binoculars inoperable.
6. Keep in mind that the binoculars are not water or weather resistant. If water splashes onto the binoculars, allow them to dry naturally, then wipe away any residual dirt with a clean, soft, dry cloth.
7. Binoculars should be stored in a well-ventilated place to prevent fungus growth. Never store them in a closet with mothballs or in an environment where chemicals are handled.

English

How to Use

1. Adjusting the eyepiece width.

Turn the central focusing wheel until it stops. The eyepiece lenses are positioned for operation. (See 1-1)

While looking at a distant object through both the right and left eyepiece lenses, slide the cover outwards or inward to adjust the eyepieces separation so that the eyepieces are comfortably in front of your eyes. (See 1-2)

2. Adjusting the diopter control.

While looking at a distant object through the left eyepiece lens with your left eye, and your right eye closed, turn the central focusing wheel until the object appears sharp. (See 2-1)

Next, while looking at the same object through the right eyepiece lens with your right eye, and your left eye closed, turn the diopter adjusting ring until the object appears sharp. (See 2-2)

Once proper focusing has been set, object at different distances can be viewed by turning only the central focusing wheel.

3. Attaching Neck Strap

To attach the strap to the binoculars, pass the strap ring through the strap hook, then pass the end of the strap through the strap ring and gently pull the strap until it is tight. (See 3)

- ⑧ Strap hook
- ⑨ Strap ring
- ⑩ Strap

1-1

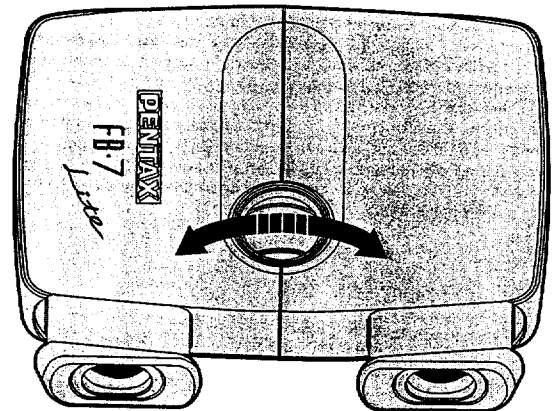

1-2

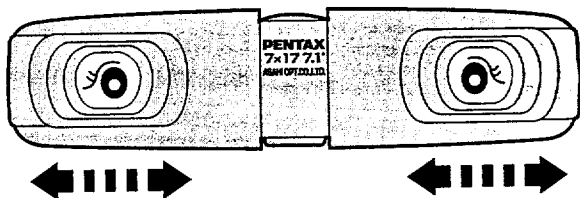

2-1

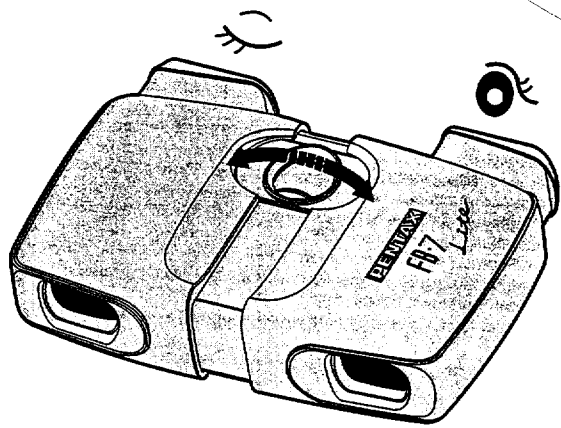

2-2

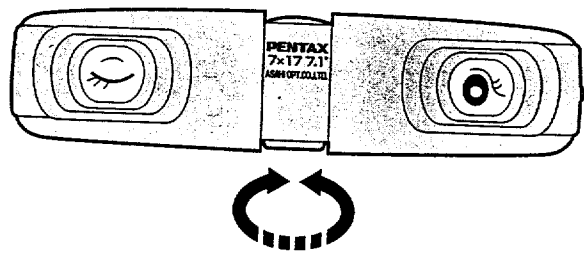

3

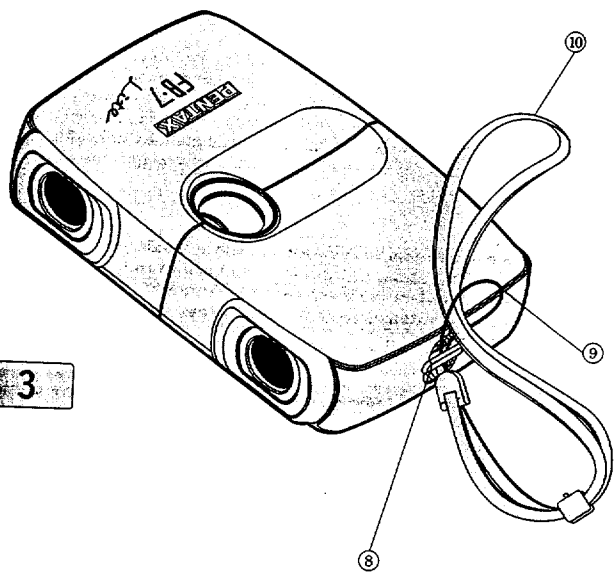

Free Manuals Download Website

<http://myh66.com>

<http://usermanuals.us>

<http://www.somanuals.com>

<http://www.4manuals.cc>

<http://www.manual-lib.com>

<http://www.404manual.com>

<http://www.luxmanual.com>

<http://aubethermostatmanual.com>

Golf course search by state

<http://golfingnear.com>

Email search by domain

<http://emailbydomain.com>

Auto manuals search

<http://auto.somanuals.com>

TV manuals search

<http://tv.somanuals.com>