

# PENTAX®

***IQZoom60-R***

***IQZoom60-R*** DATE

OPERATING MANUAL

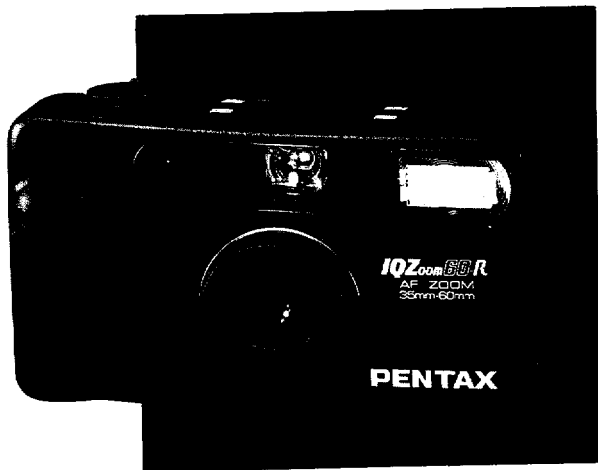

## OUTLINE OF BASIC OPERATIONS

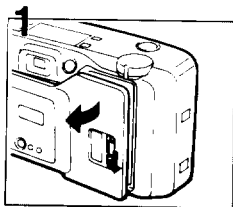

1 Open the back cover (see page 8).

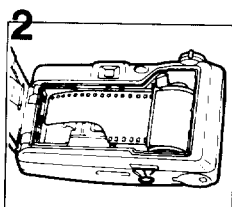

2 Load the film and close the back cover (see page 9).

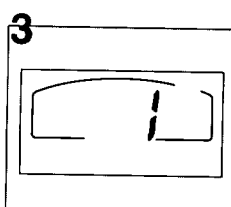

3 The film will automatically advance to the first frame (see page 9.)

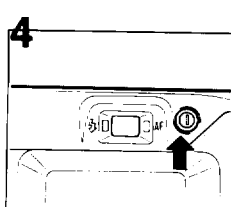

4 Push the main switch to switch on power (see page 4).

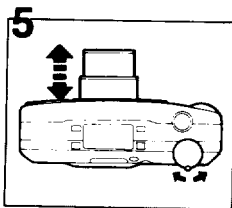

5 Frame your subject and operate the zooming lever to compose the shot (see page 6).

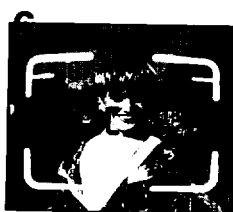

6 Focus on your subject (see page 12).



7 Depress the shutter release button. In dark conditions, the flash will discharge automatically (see page 13).

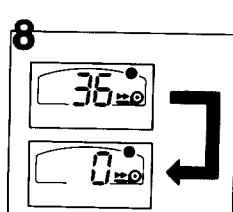

8 When the film reaches its end, the camera will automatically re-wind it (see page 16).

Congratulations on your purchase of Pentax IQ Zoom 60-R and welcome to the world of Pentax zoom compact photography! Your compact, light weight camera is a great companion to preserve your favorite memories. Its built-in 35-60 mm zoom lens gives you the freedom to frame everything from breathtaking landscapes to family portraits, even detailed close-ups. The built-in auto flash helps you to capture subjects in dimly-lit places or to photograph indoor scenes with clarity and brilliance. It functions as a fill-in flash for daylight flash-sync photography. Since most of the operations - including film loading, film speed setting, winding/rewinding, focus and exposure control - are automatic, you can take great pictures with little effort. The DATE model makes it easy to remember the dates when you took pictures.

- Please read this manual carefully before operating the camera to take consistently superior pictures.
- Pay special attention to the cautions and notes in this Operating Manual. Pictures and illustrations shown herein may differ from the camera's actual appearance.

### Icon indicators used in this manual

Operation direction	←
Automatic operation	←-----→
Attention	○ (dashed)
Lamp lighting	☀ (solid)
Lamp blinking	☀ (dotted)
Correct	○ (solid)
Incorrect	✕

The names of the camera's working parts are listed on the front and back flaps of this manual. Keep the flaps unfolded for quick reference while reading the manual.

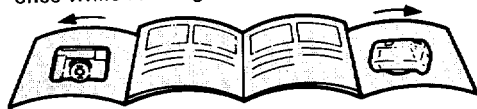

## NAMES OF WORKING PARTS

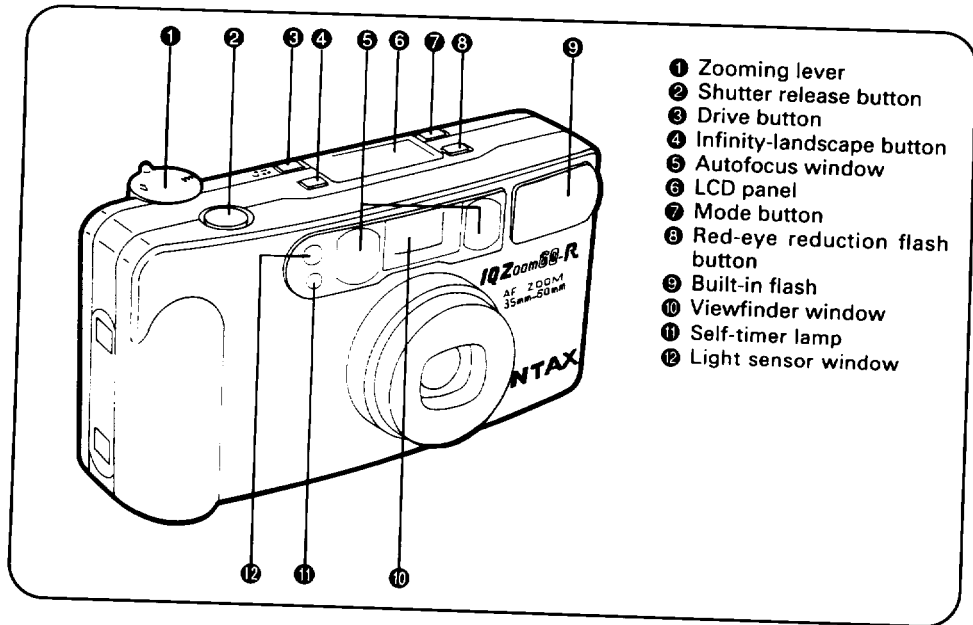

### **CAUTIONS**

- The electric circuitry inside the camera contains high voltage working parts. Never attempt to disassemble the camera.
- Be careful not to drop or subject the camera to strong vibrations, shock or pressure.
- Do not apply force to the zoom lens; do not place the camera with the lens facing down.
- Never attempt to manually open the lens cover: it will automatically open and close as the main switch is turned on and off.
- Make sure not to obstruct the autofocus window, lens, light sensor window, or the built-in flash with your fingers or hair.
- Avoid leaving the camera for extended periods of time where temperature and humidity are high such as in a car.
- Dirt, mud, sand, moisture, toxic gas, water, salt water, etc., penetrating the inside of the camera may cause damage or render it inoperable. Therefore, handle it with great care.
- Never use solvents such as paint thinner, alcohol or benzene to clean the camera.

### **PRECAUTIONS FOR BATTERY**

- The misuse of battery can cause hazards such as leakage, overheating, explosions, etc. Battery should be inserted with the "+" and "-" sides facing correctly.
- Never try to disassemble, short or recharge the battery. Also, do not dispose of the battery in a fire, as the battery may explode.
- Battery performance may be hindered temporarily in low temperatures, but it will recover in normal temperatures.
- Keep a spare battery on hand for convenience when shooting outdoors or while traveling.
- Keep the battery out of reach of children.
- When the camera is in a bag, make sure the main switch is off: otherwise, battery power may be wasted if the shutter release button is pushed accidentally.

# TABLE OF CONTENTS

- Names of working parts ..... Flaps
- Introduction ..... Front foldout
- Outline of basic operations .... Inside cover
- Cautions ..... 1

## PREPARATIONS BEFORE TAKING PHOTOGRAPHS

1. Strap attachment ..... 3
2. Main switch and battery check ..... 4
3. How to hold the camera ..... 5
4. Operating 35 - 60mm zoom lens ..... 6

## TAKING PHOTOGRAPHS

1. Usable film ..... 7
2. Film loading ..... 8
3. Viewfinder displays and shooting ranges ..... 10
4. Green/red lamps ..... 11
5. Ordinary photography ..... 11
6. Taking pictures ..... 12
7. Focus-lock shooting ..... 14
8. Unloading film ..... 16

2

## TAKING BETTER PHOTOGRAPHS

- How to select modes
  - /Red-eye reduction flash mode ..... 18
- Daylight-synchro shooting ..... 19
- Taking pictures at slow shutter speed ..... 20
- Slow-shutter-speed synchro shooting ..... 20
- Backlight compensation ..... 21
- Bulb shooting ..... 22
- Bulb-synchro shooting ..... 22
- Self-timer shooting ..... 23
- Dual-frame self timer shooting ..... 23
- Auto tele-wide self-timer ..... 24
- Consecutive shooting ..... 25
- Multi-exposure shooting ..... 26
- Interval shooting ..... 27
- Infinity-landscape shooting ..... 28
- Date model ..... 30

## MAINTENANCE CONSIDERATIONS

- Battery exhaustion warning ..... 32
- Installing/Replacing the battery ..... 33
- Taking care of your camera ..... 34
- Troubleshooting ..... 36
- Specifications ..... 38
- Warranty policy ..... 40
- LCD panel ..... Back foldout

## PREPARATIONS BEFORE TAKING PHOTOGRAPHS

You should be aware of certain fundamentals to make it easier to use this camera in the best way.

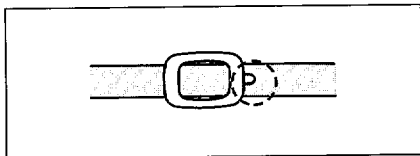

## 1. STRAP ATTACHMENT

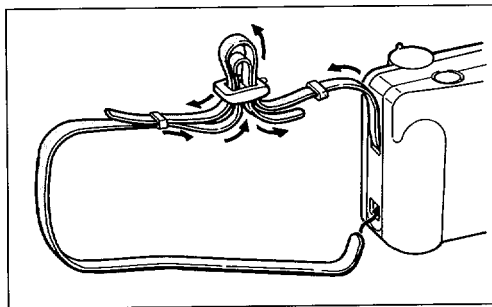

Fit the strap on the camera as illustrated. Use the clamp's protrusion to depress the ADJUST button on the date model, and to open the battery chamber cover.

- To prevent the camera from swaying excessively while walking, adjust the strap so the camera rides above your waist.

## 2. MAIN SWITCH AND BATTERY CHECK

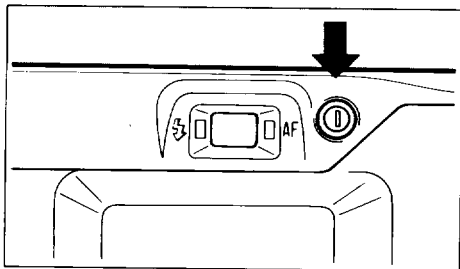

### Main switch

To switch on, push the main switch button. The lens extends slightly to the wide-angle 35mm setting and LCD panel is on. To switch off, push the main switch button again. Make sure the camera is switched off when not in use.

- Use one 3V lithium battery, type DL123A or CR123A. Do not remove the battery before it is exhausted, since it is also used by the date function on the DATE model to keep constant track of time.
- The lens cover automatically opens and closes when the main switch is on and off. Never attempt to open the lens cover manually.

4

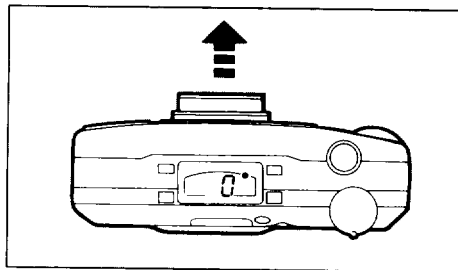

### Battery check

After you turn the main switch ON, the lens slightly extends and the lens cover opens. Then, you are ready to shoot. (See page 32 when the battery exhaustion symbol (⏻) appears on the LCD panel.)

- \* If the camera is on and left unused for over 3 minutes, the lens automatically retracts and the power switches off to save battery power. If the main switch is turned on within 60 minutes of auto-power off, the previous setting will return.
- Refer to page 33 for directions on battery insertion.



### 3. HOW TO HOLD THE CAMERA

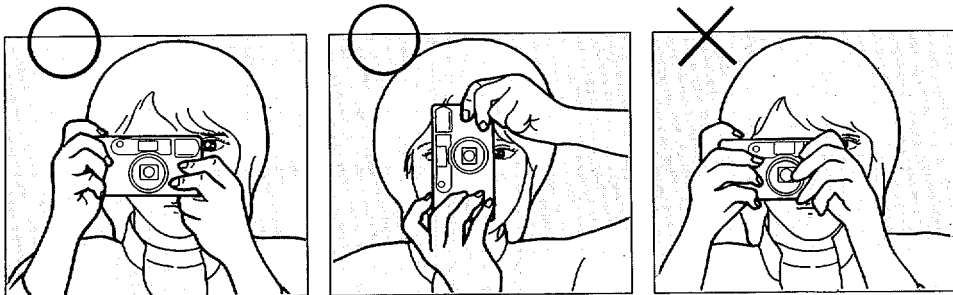

When shooting, hold the camera securely with both hands. Keep the camera as still as possible, and gently depress the shutter release button. (If too much force is applied, the camera is likely to shake, and the picture will be blurred.) Try to brace your elbows against your body, or support yourself and the camera against a stable, stationary object, such as a wall.

When using the flash with the camera positioned vertically, hold the camera so that the flash is above the lens.

**Caution:**

Do not hold the zoom lens because it moves back and forth when zooming.

**Note:**

- Make sure not to obstruct the autofocus window, lens, light sensor window or the built-in flash with your fingers or hair.

#### 4. OPERATING 35–60 mm ZOOM LENS

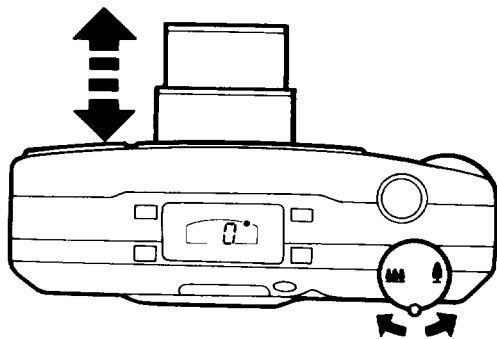

When you move the zooming lever to the right (↗), the lens moves towards the 60 mm telephoto setting and frames the subject more closely. When you move the zooming lever to the left (↖), the lens moves towards the wider-angle 35mm setting. When the lens zooms to the desired setting, release the zooming lever and depress the shutter release button fully to take pictures.

**Note:**

- The shutter cannot be released when zooming.

## TAKING PHOTOGRAPHS

After familiarizing yourself with operations on the camera by reading this instruction manual, you're ready to insert the film.

### Notes:

- When buying DX-coded films, make sure the package bears the "DX" mark.
- Non-DX coded film cannot be used.
- Use high-speed film with an ISO rating of 1000 or higher mainly for shooting indoors or in dimly-lit conditions.

## 1. USABLE FILM

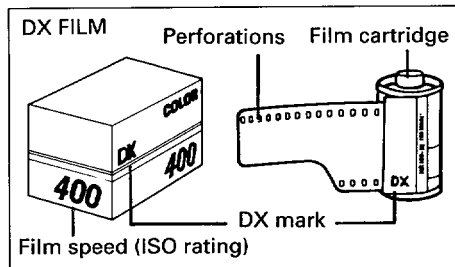

### Automatic film speed setting

This camera is designed to use DX-coded films with ISO ratings from 25 to 3200. When any of these films are loaded, the proper film speed is automatically set for the camera.

## 2. FILM LOADING (Make sure the power is off before inserting the film.)

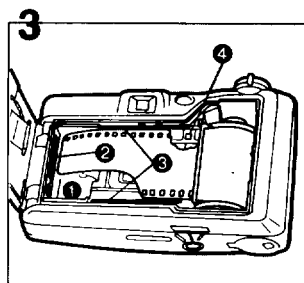
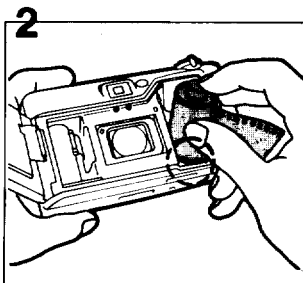
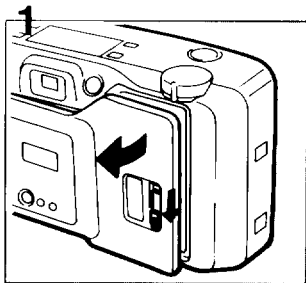

- 1 Slide the back cover release lever down in the direction of the arrow to open the back cover as illustrated.
- 2 Place the film cartridge in the film chamber by fitting its flat side on top of the rewind shaft first and then slide the top end into the camera.
- 3 Pull the film leader out far enough from the cartridge to reach the take-up spool ①. Align the tip with the film leader end mark ②.

### Notes:

- Make sure not to touch the lens with your fingers.
- Make sure the film is placed properly between the guide rails ③.
- If there is dirt on the film detection section ④, film cannot be wound properly.

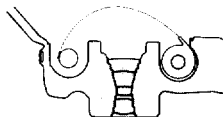

× Slack NO!

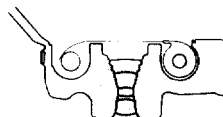

○ Flat YES!

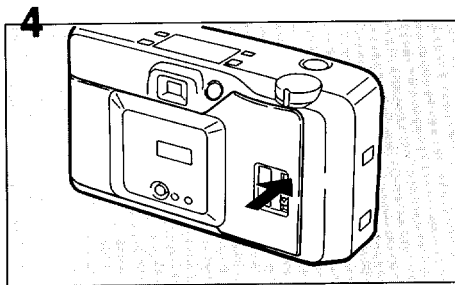

- 4 After the back cover is closed, the film automatically advances to the first frame.
- \* Even if no film is loaded, the motor operates for a second or two after the back cover is closed.

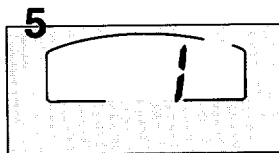

- 5 When ( / ) appears in the exposure counter on the LCD panel, the film automatically stops winding. The indication appears as shown above. If ( / ) does not appear on the LCD panel, it indicates that the film is not properly loaded. If this occurs, reload the film. If ( E ) blinks on the LCD panel, it means the film is not properly loaded.
- \* The exposure counter indication will remain on even if the main switch is turned off.

- Make sure the film is taut as illustrated on previous page. Take up any slack in the film by pushing it back into the cartridge.
- If the end of the film leader is extremely bent, straighten it or cut off the bent portion.

### 3. VIEWFINDER DISPLAYS AND SHOOTING RANGES

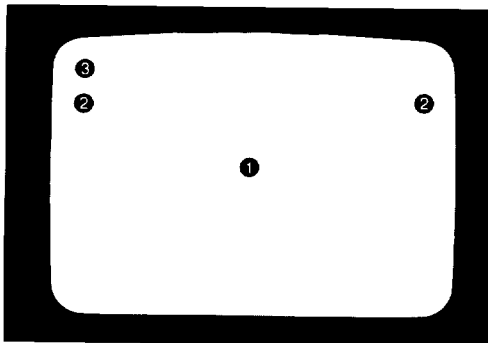

First, switch on power by depressing the main switch button.

- ① Autofocus frame  
Focus on the subject with this frame.
- ② Close distance compensation frame  
When the camera-to-subject distance is between 0.6m (2ft) and 1m (3.3ft), compose the picture within this frame.
- ③ Picture area  
When taking a normal picture, compose the picture within this frame.

Shooting ranges (effective camera-to-subject distance)

- The ordinary setting allows a shooting range from  $\infty$  (infinity) to 0.6 meter (2ft).
- Subjects closer than 0.6 meter (2ft) cannot be focused properly.

## 4. GREEN/RED LAMPS

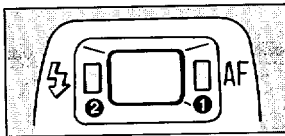

When you depress the shutter release button halfway, the lamps ① and/or ② light up or blink as shown at left.

- ① Green lamp: When the subject is in focus, it will light up to indicate that you can take the picture; when the subject is not in focus, it will blink, indicating that you cannot take the picture because the camera-to-subject distance is too close.
- ② Red lamp: When the flash is ready to discharge, it will light up. When the flash is being charged, it will blink.

### Notes:

- If the subject is too close, the green lamp blinks. Adjust the camera-to-subject distance so that the green lamp lights continuously, then release the shutter.
- If the subject is even closer (approx. 30cm), the green lamp may light continuously.

## 5. ORDINARY PHOTOGRAPHY



When the power is switched on by depressing the main switch button, the camera auto-

matically selects the Auto and Single-Frame Shooting modes and the exposure counter indication remains on even if the main switch is turned off. These modes are used for taking ordinary pictures. The built-in flash will discharge automatically when the subject is poorly illuminated.

- When the LCD panel displayed is different from the one shown above (which indicates the other modes are set), switching power OFF and then ON restores the Auto and Single-Frame Shooting modes.
- \* When the built-in flash automatically discharges, the camera uses the shutter speed approx. 1/40th sec. (when ISO100 film is used).

## 6. TAKING PICTURES Shooting distance: 0.6m(2ft) - ∞ (Infinity)



### 1 Composing the shot

After zooming the lens and composing your shot, focus on the subject with the autofocus frame in the center of the viewfinder.

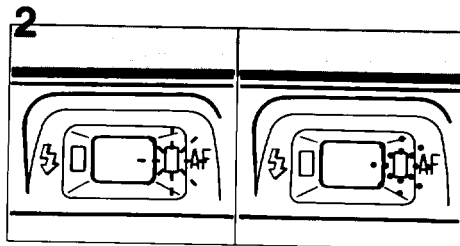

### 2 Checking the lamp indication

Depress the shutter release button halfway. When your subject is in focus, the green lamp will light up. If the subject is closer than 0.6 meter (2ft), the green lamp will blink. In this case, lengthen the camera-to-subject distance.

- When the red lamp lights up, it indicates that the built-in flash will discharge. Make sure that you are within the flash effective range before shooting. (see page 13.)



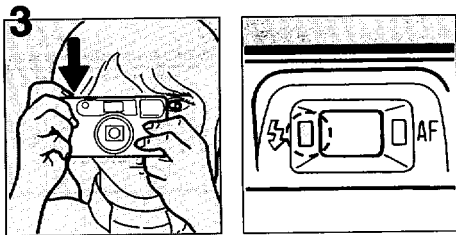

### 3 Shooting

Depress the shutter release button fully, and the shutter will release. Then, the film automatically advances to the next frame.

#### Notes:

- When the shutter is released, the self-timer lamp lights up momentarily to indicate that a picture has been taken.
- If you wish to focus on another subject, lift your finger off the shutter release button and depress the shutter release button halfway again.
- The shutter cannot be released while the lens is zooming.

### Automatic Flash Emission

When taking pictures in low light, the flash will automatically discharge. When the shutter release button is depressed halfway in low light, the red lamp will light up, indicating the flash is ready to discharge. If the red lamp blinks, this indicates that the built-in flash is being charged. Therefore, make sure the red lamp lights continuously before taking pictures.

### Red-eye

Shooting portraits with the flash may result in "red-eye", the red dot in your subject's eye. This camera includes a red-eye reduction flash function, which suppresses the red-eye phenomenon by using preflash. See page 18 for details.

### Flash effective ranges (Nega-color film used)

Lens	ISO	100	200	400
Wide-angle 35mm (▲▲▲)		0.6-4.3m	0.6-6.0m	0.6-8.6m
Telephoto 60mm (▲)		0.6-2.9m	0.6-4.1m	0.6-5.8m

## 7. FOCUS-LOCK SHOOTING



If you shoot without positioning the autofocus frame ( [ ] ) on the main subject of the picture as shown above, only the background will be in focus. When the main subject is off the autofocus frame in the center of the viewfinder, use the focus-lock technique. ( Focus-lock is the function to lock focus.)

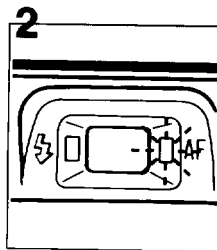

- 1 Focus on the subject with the autofocus frame ( [ ] ).  
When you wish to focus on the face, which appears very small in the viewfinder, focus on the chest instead to fill the focus frame with more of the subject.
- 2 When the shutter release button is depressed halfway down, the green lamp on the right-hand side of the viewfinder lights up and the exposure and focus are temporarily locked.



3 While depressing the shutter release button halfway, re-aim the camera or recompose the picture, then release the shutter.

**Note:**

- You can release focus-lock simply by lifting your finger off the shutter release button.

### **Hard-to-autofocus subjects**

Like many other autofocus cameras, the camera's autofocus system is highly precise, but not perfect. Some subjects may not be focused as you wish. In such a case, use the focus-lock technique on a subject near the actual one and equidistant from the lens. Subjects which may fool the system include:

1. Black objects like hair, which don't reflect much light (and therefore don't reflect infrared autofocus beams).
2. Wire netting, latticework, iron exercise-bars, etc.
3. Flickering light sources such as neon signs, fluorescent lamps, TV images, sunlight coming through trees, etc. and subjects illuminated by these light sources.
4. Glossy and reflective surfaces like glass, mirrors, car bodies, etc.
5. Fast-moving objects, like trains or automobiles in motion.
6. Water jets, water surface, smoke, flame, fireworks, etc., which have no distinct or consistent form, or a subject in mist.

## 8. UNLOADING FILM (Be sure to remove the film from the camera in the shade or by using your body to shade the camera.)

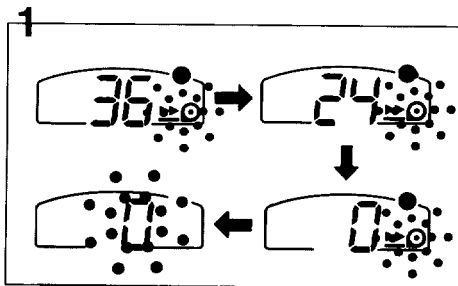

### 1 Rewinding the film

After you have exposed the last frame of the roll, the film rewinds automatically. Then, the motor stops, and ( 0 ) blinks as shown to indicate that the film has been rewound.

- 24-exposure roll of film takes about 20 seconds to be rewound.
- During rewinding, the exposure counter counts frame numbers in reverse.
- The entire roll of film including the film leader is always rewound into the cartridge to prevent any parts of the film being exposed to light.

16

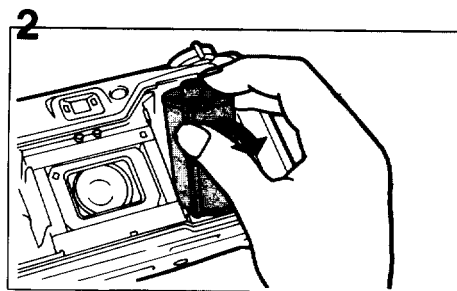

### 2 Unloading the film

Open the back cover, and remove the cartridge from the chamber by pulling the top out first with your finger.

#### Notes:

- The shutter may be released a frame or two even after the specified number of frames have been used up as indicated by the number of shots shown on the film canister. If this occurs, those frames may not be developed.
- Never open the back cover until the whole film roll is rewound.

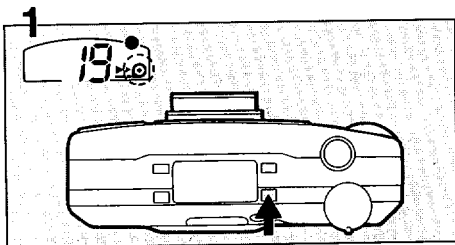

### Rewinding a film in mid-roll

If you wish to unload a film before exposing all the frames, follow the procedures as follows.

- 1 Turn the main switch ON and keep the drive button depressed for more than 3 sec., the rewind mode will be set and the (➤⊙) mark appears on the LCD panel. The (•) mark will also blink on the LCD panel.

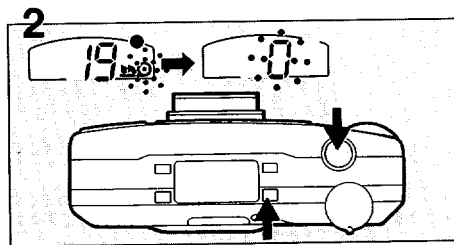

- 2 Depressing the shutter release button while holding the drive button down starts the rewinding. When the roll of film is re-wound to its end, the motor stops and the (0) blinks indicating that the back cover may be opened safely.

# TAKING BETTER PHOTOGRAPHS HOW TO SELECT MODES/RED-EYE REDUCTION FLASH MODE

To select various exposure modes, depress the mode button ①.

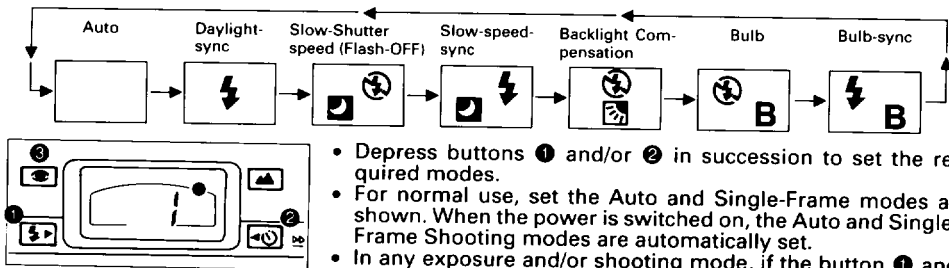

- Depress buttons ① and/or ② in succession to set the required modes.
- For normal use, set the Auto and Single-Frame modes as shown. When the power is switched on, the Auto and Single-Frame Shooting modes are automatically set.
- In any exposure and/or shooting mode, if the button ① and ② is depressed after the shutter is released, the Auto and Single frame modes will return respectively.
- To reduce the red-eye phenomenon in the picture, depress the red-eye reduction flash button (👁) ③. With this mode, the flash discharges two consecutive times, reducing the possibilities of the red-eye effect significantly. To cancel the mode, depress the red-eye reduction button again.

To select the desired shooting modes, depress the drive button ②.

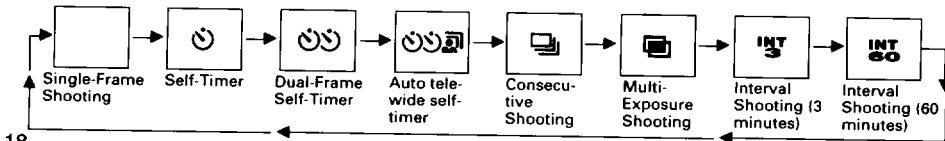

## DAYLIGHT-SYNCHRO SHOOTING

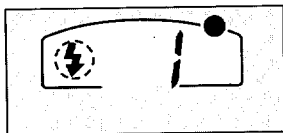

Depress the mode button until the (⚡) appears on the LCD panel. The flash will dis-

charge both in dark and bright conditions. When a portrait is taken with the subject in a backlit situation, the front of your subject may be cast in shadow. In such a case, use the Daylight-Synchro Shooting mode (Flash-ON mode) within the appropriate flash effective range to take pictures. This will ensure that a picture is well exposed without any shadow. The flash will always discharge in this mode.

### Notes:

- Make sure the red lamp on the left-hand side of the viewfinder eye-piece lights up when the shutter release button is depressed halfway down before shooting. A red lamp blinking indicates that the flash is being charged.
- Make sure you're within the flash effective range even when you use the built-in flash as a fill-in flash in daytime. (see page 13.)



Without Daylight-Sync



With Daylight-Sync

## TAKING PICTURES AT SLOW SHUTTER SPEED

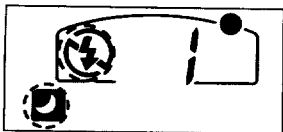

### Slow Shutter Speed (Flash-Off)

Depress the mode button until the (⏏ ⚡)

symbol appears on the LCD panel. In this mode, the flash does not discharge, and a picture is taken at a slow shutter speed up to approx. 1/5 second. Use it in places where using flash is prohibited, such as in theaters, museums, etc. Furthermore, this mode is also useful for soft-lighted pictures with a natural atmosphere.

### Notes:

- When shooting in darkness, the shutter speed gets slower, and camera shake is more likely to blur your picture, so use a tripod.

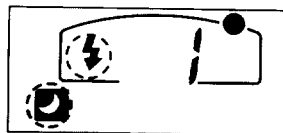

### Slow-Speed-Synchro-Shooting (Flash-On)

Depress the mode button to set a slow-speed-sync mode until the (⏏ ⚡)

symbol appears on the LCD panel. It is possible to take a picture of subjects and background in a balanced way, as shown in the photo, by using the built-in flash to properly expose the foreground subject and a slow-shutter-speed to expose the low light background.





## Backlight Compensation



Portraits with a window, blue sky or other bright background often results in

underexposure because the exposure is automatically set for the background. Backlight Compensation makes good use of natural lighting to improve the balance of light between the subject and the rest of the picture. Also use this mode to shoot scenery. Depress the mode button until the (⚡) (📷) indication appears on the LCD panel.

### Note:

- When using Backlight Compensation in a dimly-lit place, the shutter speed may be so slow that you should use a tripod to prevent camera shake.



Without Backlight Compensation



With Backlight Compensation

## BULB, BULB-SYNCHRO SHOOTING

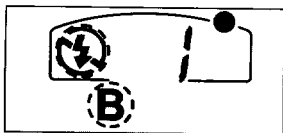

### Bulb mode (B)

Depress the mode button until (⊕ B) appears on the

LCD panel. The shutter remains open as long as the shutter release button is held down. This mode is useful for long exposures required for shooting fireworks and night scenes, for instance. When using this mode, the camera should be mounted on a tripod so that the camera will be steady.



Bulb mode, approx. 3 sec. (ISO100)

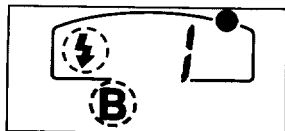

### Bulb-synchro mode (⚡ B)

If the mode button is depressed, (⚡ B) appears on the

LCD panel and Bulb-synchro mode is set. This lets you use the flash in addition to the Bulb mode, so you can take a portrait with a night scene in the background, for example.

## SELF-TIMER PHOTOGRAPHY

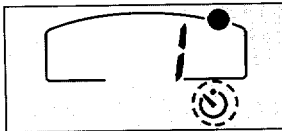

### Self-Timer

Use the self-timer if you wish to get in the picture. Use of a tripod is

recommended. Depress the drive button until the (  ) appears on the LCD panel.





### Dual-Frame Self-Timer

In this mode, you can take two consecutive self-timer

pictures.

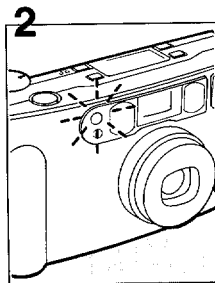
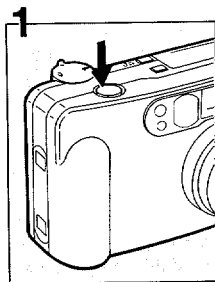
Depress the drive button until the (  ) symbol appears on the LCD panel. Depress the shutter release button. The first frame will be exposed after approx. 10 seconds, then the second frame approx. 5 seconds after the first. Note that focus for both shots is locked at the first frame.



- 1 Focus on the subjects first by depressing the shutter release button halfway, and then depress the shutter release button fully. The shutter will be released in about 10 seconds.
- 2 When the Self-Timer is working, the Self-Timer symbol (  ) blinks on the LCD panel, and the Self-Timer lamp lights up. The lamp starts blinking 3 seconds before the shutter is released, letting you know when to smile.

## Auto Tele-Wide Self-Timer

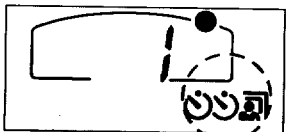

Two consecutive self-timer pictures can be taken: The first at a selected focal length;

the second at the 35mm focal length. Depress the drive button until the ( ) appears on the LCD panel. Move the zooming lever to determine the first shot's focal length, and focus on the subject or the area where the subject will appear, then depress the shutter release button. The first shot will be exposed in about 10 seconds, the lens will move to the wide-angle position, and the second shot will be exposed about 5 seconds after the first. Note that the focus is locked at the first shot.

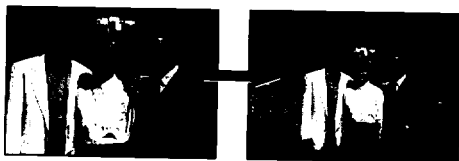

### Notes on the self-timer shooting

- If you start the self-timer while standing in front of the camera's front, the subject may not be in focus.
- To cancel the self-timer at any time after it's been activated, push the main switch. (in such a case, the power will not be turned off.)
- When you want to use the flash with the self-timer, make sure the flash has been charged (the red lamp lights up) before operating the self-timer. If the battery is exhausted, the self-timer operation may not be completed once started. In this case, replace the battery.
- When the Bulb mode is used with the self-timer, the shutter speed is automatically set to approx. 1/2 sec.

## CONSECUTIVE PHOTOGRAPHY

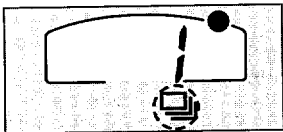

Depress the drive button until the (  ) symbol appears on the LCD panel. While the shutter release button is held down, a frame is shot every 1.3 sec.

- The camera focuses on the subjects frame by frame in this mode, so make sure to keep the autofocus frame on the subject.
- When using flash in this mode, consecutive shooting is possible only after the flash is charged (the red lamp lights up) following each exposure.

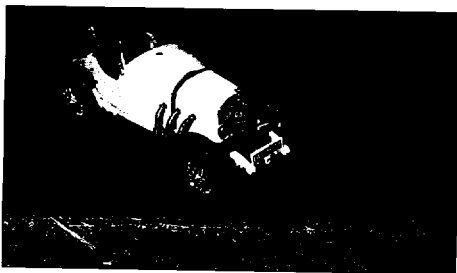

## MULTI-EXPOSURE SHOOTING



Multi-Exposure mode will disengage the film advance, letting you superimpose images on a single frame for fantastic illusions. Your imagination can produce striking creative effects.



### Procedure

1. Depress the drive button until the symbol (  ) appears on the LCD panel.
2. Depress the shutter release button to shoot an initial exposure. The film will not advance, the frame counter indication and (  ) blink on the LCD panel to indicate that you are in the Multi-exposure mode. The normal Single-Frame Exposure mode will be restored after the picture is taken.
3. Recompose the frame, and depress the shutter release button to shoot the second exposure. (After the second shot, the film will be advanced and the Single-Frame shooting mode will be restored.)

### Notes:

- To expose two or more, depress the drive button until the (  ) remains lit after the step 2 above, and then depress the shutter release button.
- The date will be exposed in step 3 above on date model cameras.
- Repeated multiple exposures tend to over-expose a frame, so it is recommended that you expose a frame just twice or 3 times at most.
- When using Multi-Exposure, you can usually get the best results with dimly-lit backgrounds, such as night scenes.

## INTERVAL SHOOTING

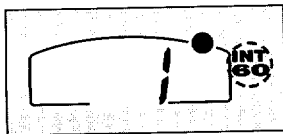
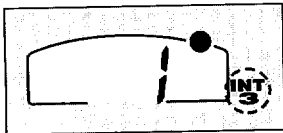

This mode lets you capture the subject at intervals of 3 or 60 minutes, making it ideal to record a sequence of events over a period of time - the blossoming of a flower, for instance. Once you set this mode, it automatically takes pictures for you unattended. It is ideal for observational photography of animals, insects or plants, etc.

1. Depress the drive button until the ( **INT** ) or ( **INT 60** ) symbol appears on the LCD panel.
- This mode allows you to shoot with an interval of 3 minutes ( **INT 3** ) or 60 minutes ( **INT 60** ).
2. Depress the shutter release button fully; the first frame will be exposed 3 seconds later. Then the rest of the film will be automatically exposed according to the interval time selected.

### Notes:

- Use of a tripod is recommended for best results.
- The focus will be locked at the first frame, and the self-timer lamp starts blinking 3 seconds before the shutter is released.
- When in the Interval Shooting mode, the interval shooting symbol mark ( **INT** ) or ( **INT 60** ) blinks on the LCD panel and the remaining time of the interval is also displayed.
- To cancel the Interval Shooting mode after it has been activated, depress the main switch. In this instance, the power is not switched off.
- The exposure counter indication appears on the LCD panel when the shutter release button is depressed halfway.

## INFINITY-LANDSCAPE SHOOTING

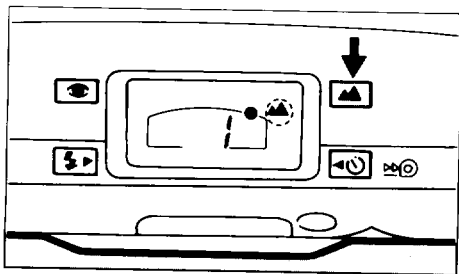

When you wish to take a sharp picture of a distant landscape or a distant subject through a window, the infinity-landscape mode allows you to take distant scenery with clarity. Depress the infinity-landscape button and the (▲) symbol appears on the LCD panel. To cancel it, depress the infinity-landscape button again.

- \* After the picture is taken by depressing the shutter release button fully, this mode is canceled. However, if this mode is used in combination with the consecutive-shooting mode, it is not canceled as long as the shutter release button is depressed.
- \* The built-in flash does not discharge when combined with the Auto and Single frame modes.







## DATE MODEL

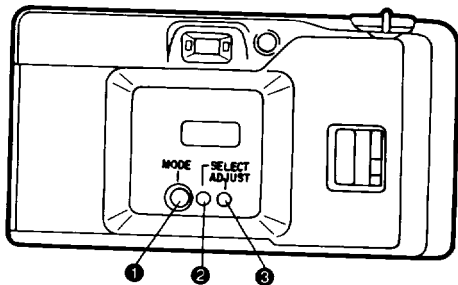

If you purchased the DATE model, read this section. The DATE model records dates up to the year 2019 on pictures.

- ① MODE button
- ② SELECT button
- ③ ADJUST button

### Switching the Mode

At each press of the MODE button ① with your fingernail, the mode in the LCD panel switches as shown in the chart.

#### Notes:

"-----" indicates no data will be imprinted.

- "M" on the LCD panel indicates "Month".
- Use the strap tool's pin-shaped protrusion to depress the SELECT and ADJUST buttons.

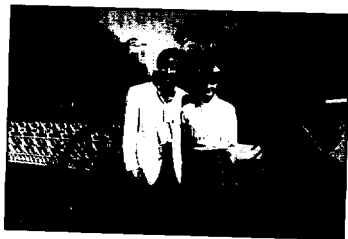
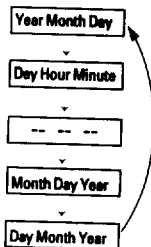

\* The date in the picture above is simulated.

### Correcting the date

1. Depress the SELECT button ② to make a different category of digits in the LCD panel you want to change to blink.
  2. Depress the ADJUST button ③ to change digits of the specified category you chose with the SELECT button ②. Digits increase by one each time you depress the ADJUST button ③. Holding down the button will advance digits continuously.
- \* The blinking ":" allows precise fine-tuning of the internal clock to the beginning of a specified minute. To do so, depress the SELECT button ② to make the ":" blink, and then depress the ADJUST button ③ in sync with a time signal.
3. After the data has been adjusted, depress the SELECT button. The bar mark (-) appears on the LCD panel, indicating that data imprinting choices are possible.
- If you release the shutter while the blinking data is being corrected, the data cannot be imprinted.

- \* Numerical indication  
Year = 87-19 (1987-2019)  
Month = 1-12  
Day = 1-31  
Time = 0-23  
Minute = 00-59



### OPERATIONAL PRECAUTIONS

The data on the LCD panel is imprinted on each frame you expose.

- \* "Year-Month-Day" and "Day-Hour-Minute" cannot both be imprinted at the same time.
- \* As you release the shutter, the bar mark (-) on the display blinks for a few seconds, indicating the data has been imprinted.
- If there is a white or yellow object in the corner of the picture where the data is imprinted, the data may be difficult to read. When composing your photographs, try to avoid brightly-colored subjects in that corner.

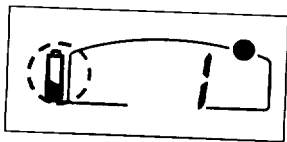
## BATTERY EXHAUSTION WARNING



When the battery is nearly exhausted, the battery symbol (  ) appears on the LCD panel to warn you. Replace the battery as soon as possible. When (  ) starts blinking, no operations can be performed.

### Battery life (using 24-exposure film rolls):

Approx. 15 rolls

Ordinary picture taking mode, 50% of shooting employs flash

(The CR123A battery was used under the Pentax testing conditions. Actual battery life/performance may vary drastically on either usage of Auto-Focus, Power Zoom and Flash and external conditions such as temperature and freshness.)

### Notes on replacing the battery:

- Make sure there is no film loaded. Switch off power before replacing the battery.
- If the battery is replaced with a film already loaded, the camera enters the starting mode. It will assume the film has just been loaded and will advance several frames. The " f " will appear on the LCD panel.
- If the battery is replaced at the end of the film roll, the camera may not detect the film, and the frame counter indication may not appear on the LCD panel. Follow the procedure for rewinding the film in mid-roll to rewind the film, and remove the film.
- The battery is used by both the main body and the date function on the DATE model to keep constant track of time. After the battery is replaced, correct the time and date. (See pages 30-31.)
- When the camera is in a bag, make sure the main switch is off: otherwise, battery power may be wasted if the shutter release button is pushed accidentally.

## INSTALLING/REPLACING BATTERY Use one 3V lithium battery (CR-123A or DL-123A)

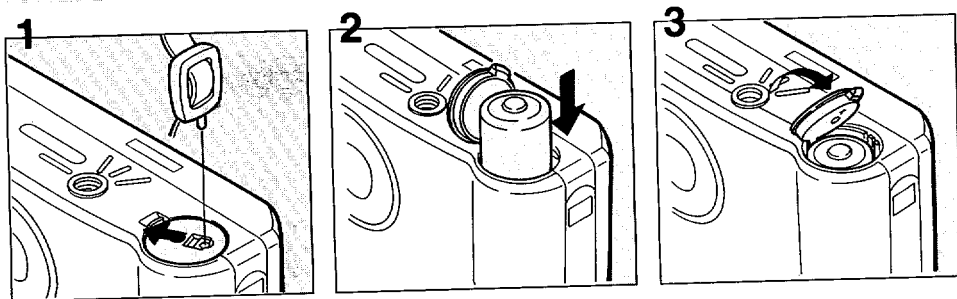

Make sure that the power is off before installing or replacing the battery.

- 1 Open the battery chamber cover by pulling the cover lock in the direction of the arrow with the strap clamp's protrusion.
- 2 Insert one lithium battery as shown.
- 3 Close the battery chamber cover. When closed properly, it locks with a click.

- If the battery is correctly loaded, the zoom lens moves slightly and the motor operates for a few seconds.
- On the DATE MODEL, the date is initialized to 87/1/1 when the battery chamber cover is opened.

## TAKING CARE OF YOUR CAMERA

Your Pentax camera is a sophisticated, precision instrument built to give long-lasting, reliable service. It should serve you well if you handle and take care of it properly.

- Be careful not to subject it to strong vibrations, shock or pressure. Use a cushion to protect the camera when carrying in a motorcycle, car, boat, etc.
- Use a blower and lens brush to remove dust accumulated on the lens or viewfinder.
- Avoid storing the camera in a wardrobe where mothballs are put among clothes or in a laboratory containing chemicals. The camera should always be stored in a cool, dry, well-ventilated place.
- Avoid leaving the camera for extended periods in places where temperature and humidity are high, such as in a car.
- If the camera is brought into a warm room from the cold outdoors, condensation may occur in the inside and on the outside of the camera. In such a case, put the camera into a case or plastic bag so that change in temperature will be as gradual as possible. After the temperature difference is minimized, take it out of the bag.

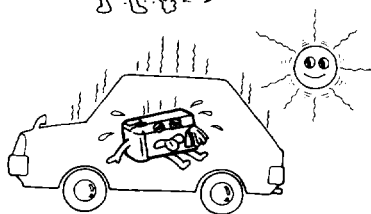

- The temperature range in which the camera functions properly is 50°C to -10°C (122°F to 14°F).
- Electrical problems may often be caused by water, dirt or dust at points of electrical contact. Also check for battery leakage, traces of dirt or grease, or corrosion due to salinity or gas. If you cannot correct the problem, have your camera inspected at a Pentax service center. Repairs of this nature are not covered under the terms of the warranty and charges may be assessed.

- Do not apply force to the zoom lens. Never place the zoom lens with the mount side facing down.
- Regular size color prints may cut off what appears on the extreme edges of the film frame. Compose your picture with a margin of safety at the edges.
- To maintain optimum performance, it is recommended that the camera be inspected every one or two years. If the camera has not been used for extended periods, or is being readied for important photographic events, it is recommended that you inspect the camera or test shoot with it.
- Repairs made necessary due to usage of this product in an industrial application may not be covered under the terms of the Pentax warranty.

### **Red-eye phenomenon in flash shooting**

When a picture is taken using a flash, a subject's eyes may appear red in the print. This phenomenon is caused by the reflection of the electronic flash in the retina. It can be reduced when the surroundings of the subject are brightened, or shooting distance is shortened with the lens set at the wide-angle position or by employing the red-eye reduction flash feature.

## TROUBLESHOOTING

What appears troublesome may be easily remedied. Here are some problems that may occur and their remedies.

<b>Symptoms</b>	<b>Causes and Remedies</b>
1. The shutter cannot be released.	<ul style="list-style-type: none"><li>• Is the main switch turned off ? If so, turn it on. (See page 4.)</li><li>• Is the battery exhausted ? Replace it or insert a new battery if it is exhausted. (See page 33.)</li><li>• Is (  ) blinking on the LCD panel ? If so, the film has been used up. Insert a new roll. (See page 16.)</li><li>• Are you depressing the zooming lever ? If so, release the zooming lever, then shoot. (See page 13.)</li></ul>
2. My printed pictures don't look very clear.	<ul style="list-style-type: none"><li>• Did you position the autofocus frame on your subject ? (See page 12.)</li><li>• Did you obstruct the autofocus window with your fingers or hair when you depressed the shutter release button ? (See page 5.)</li><li>• Was the subject too near ? Shoot in the range of 0.6 meters (2ft) to <math>\infty</math> (infinity). (See page 10.)</li></ul>
3. Zoom lens retracted automatically (the power is turned off automatically).	<ul style="list-style-type: none"><li>• Did you leave the camera unused for over 3 minutes after the main switch was turned on ? The power is automatically switched off if the camera is left unused for over 3 minutes. (See page 4.)</li></ul>



Symptoms	Causes and Remedies
4. The [H] or [U] mark is displayed on the LCD panel.	<ul style="list-style-type: none"> <li>If either mark disappears when the zoom lever is moved, the camera is ready for use. The camera may be defective if either mark appears often.</li> </ul>

The correct camera-to-subject distances when shooting using flash with films other than ISO 100, 200 or 400 are indicated in the table below.

Lens	ISO	25	50	1000	1600	3200
35mm (▲▲▲)		0.6-2.1m	0.6-3.0m	1.1(*)-13m	1.4(*)-16m	2.0(*)-22m
60mm (▲)		0.6-1.5m	0.6-2.1m	0.6-9.2m	1.0(*)-12m	1.4(*)-17m

\* With high speed film overexposure may occur at close range.

## SPECIFICATIONS

- Type:** 35mm fully automatic leaf-shutter camera with built-in zoom lens and auto flash
- Film:** Auto film speed setting with 35mm perforated DX-coded film with ISO rating from 25 to 3200 (1 EV step). Non-DX coded films are automatically set to ISO25. 24x36mm format
- Film loading:** Auto film loading. Closing the back cover will automatically wind the film to first exposure
- Film winding:** Auto film-winding: Two auto film-winding modes; single frame mode and consecutive mode (approx. 1.3 sec./frame).
- Film rewinding:** Auto start at the end of roll. Auto stop upon completion of rewinding. Rewinding time: approx 20 sec. with 24-exposure film. Rewinding in mid-roll provided.
- Frame number:** Automatic readout of successive frame numbers in ascending order when shooting, and descending order when rewinding.
- Lens:** Pentax power zoom 35-60mm f/4.3-6.7 8 elements in 7 groups, Angle of view: 63°-39.5°
- Focusing system:** Pentax infrared active autofocus with focus lock, Range: 0.6m (2ft) - infinity, Infinity-landscape mode (focus is fixed to infinity) Maximum magnification: 1/9X
- Zooming:** Electronic zoom
- Shutter:** Programmed AE electronic shutter with speeds approx. 1/400 sec. 1/5sec. Bulb:1/2sec.or slower ie, for as long as the shutter release button is depressed, Electromagnetic release
- Self-timer:** Electronic red lamp indication. Approx. 10-sec. delay with LED indication. Cancellation after activation is possible. 2 consecutive shots provided in Dual-frame self-timer mode. Auto tele-wide self-timer mode can take two consecutive pictures: the first at the selected focal length; the second at the wide-angle setting.
- Viewfinder:** Actual image zoom viewfinder: 83% field-of-view ratio. Magnification: approx. 0.37X(35mm WIDE)-0.56X(60mm TELE), Diopter:fixed at -1 diopter, AF frame, Picture frame, Close distance compensation frame, Green lamp lighting on the right hand side of the viewfinder: in-focus signal, Green lamp blinking: close-distance warning, Red lamp lighting on the left hand side of the viewfinder: Flash-ready status, Red lamp blinking: Flash being charged

**Exposure control:** Programmed auto-exposure control. Range: EV10-17 at 35mm WIDE, EV11.5-17 at 60mm TELE in Auto or Daylight-Synchro mode (ISO 100), EV6.5-17 in 35mm WIDE, EV8-17 at 60mm TELE in Slow-Shutter-Speed or Interval Shooting mode

**Backlight compensation:** +1.5EV

**Multi-exposure:** Multiple exposure function provided

**Exposure-meter switch:** The exposure meter is turned on by half depression of the shutter release button

**Flash:** Built-in zoom flash with red-eye reduction mode, Automatic low-luminance firing in Auto mode, Flash-ON=Daylight-Synchro/Slow-Shutter-Speed Synchro (up to 1/5 sec.), Flash-OFF=Flash override, Slow-Speed-Shutter/Bulb, Bulb-Synchro=1/2 sec. or more

**Flash effective range:** 0.6-4.3m (35mm WIDE), 0.6-2.9m (60mm TELE), (ISO100 film used)

**Flash recycling time:** Approx. 5 sec. under the Pentax testing conditions

**Interval shooting:** Electronically controlled, started by depressing the shutter release button: 3 and 60 minutes can be selected for interval time

**Power source:** One 3V lithium battery (CR-123A or DL-123A)

**Battery life:** Approx. 15 rolls of 24 exposure film when 50% of shooting employs flash (under the Pentax testing conditions)

**Battery exhaustion warning:** ( ) appears on the LCD panel, Shutter is locked when the ( ) is blinking

**Data mechanism:** Crystal quartz controlled; LCD with digital clock, auto calendar

**Imprinting mode:** "Year, Month and Day", "Day, Hour and Minute" or blank

**Size & weight:** 122(W) × 66(H) × 38.5(D)  
(4.8"x2.6"x1.5")

235 grams, (8.3 oz.) without battery.

**DATE model:**

122(W) × 66(H) × 41(D) mm (4.8" × 2.6" × 1.6")  
240 grams, (8.5 oz.) without battery.)

**SPECIFICATIONS ARE SUBJECT TO CHANGE AT ANY TIME WITHOUT NOTIFICATION OR ANY OBLIGATION ON THE PART OF THE MANUFACTURER.**

## WARRANTY POLICY

All Pentax cameras purchased through authorized bona fide photographic distribution channels are guaranteed against defects of material or workmanship for a period of twelve months from date of purchase. Service will be rendered, and defective parts will be replaced without cost to you within that period, provided the equipment does not show evidence of impact, sand or liquid damage, mishandling, tampering, battery or chemical corrosion, operation contrary to operating instructions, or modification by an unauthorized repair shop. The manufacturer or its authorized representatives shall not be liable for any repair or alterations except those made with its written consent and shall not be liable for damages from delay or loss of use or from other indirect or consequential damages of any kind, whether caused by defective material or workmanship or otherwise; and it is expressly agreed that the liability of the manufacturer or its representatives under all guarantees or warranties, whether expressed or implied, is strictly limited to the replacement of parts as hereinbefore provided. No refunds will be made on repairs performed by non-authorized Pentax service facilities.

40

**Procedure During 12-month Warranty Period**  
Any Pentax which proves defective during the 12-month warranty period should be returned to the dealer from whom you purchased the equipment or to the manufacturer. If there is no representative of the manufacturer in your country, send the equipment to the manufacturer, with postage prepaid. In this case, it will take a considerable length of time before the equipment can be returned to you owing to the complicated customs procedures required. If the equipment is covered by warranty, repairs will be made and parts replaced free of charge, and the equipment will be returned to you upon completion of servicing. If the equipment is not covered by warranty, regular charges of the manufacturer or of its representatives will apply. Shipping charges are to be borne by the owner. If your Pentax was purchased outside of the country where you wish to have it serviced during the warranty period, regular handling and servicing fees may be charged by the manufacturer's representatives in that country. Notwithstanding this, your Pentax returned to the manufacturer will be serviced free of charge according to this procedure and warranty policy.

---

In any case, however, shipping charges and customs clearance fees are to be borne by the sender. To prove the date of your purchase when required, please keep the receipts or bills covering the purchase of your equipment for at least a year. Before sending your equipment for servicing, please make sure that you are sending it to the manufacturer's authorized representatives or their approved repair shops, unless you are sending it directly to the manufacturer. Always obtain a quotation for the service charge, and only after you accept the quoted service charge, instruct the service station to proceed with the servicing.

**The warranty policy does not apply to Pentax products purchased in the U.S.A., UK, or Canada. The local warranty policies available from Pentax distributors in those countries supersede this warranty policy.**

## NAME OF WORKING PARTS

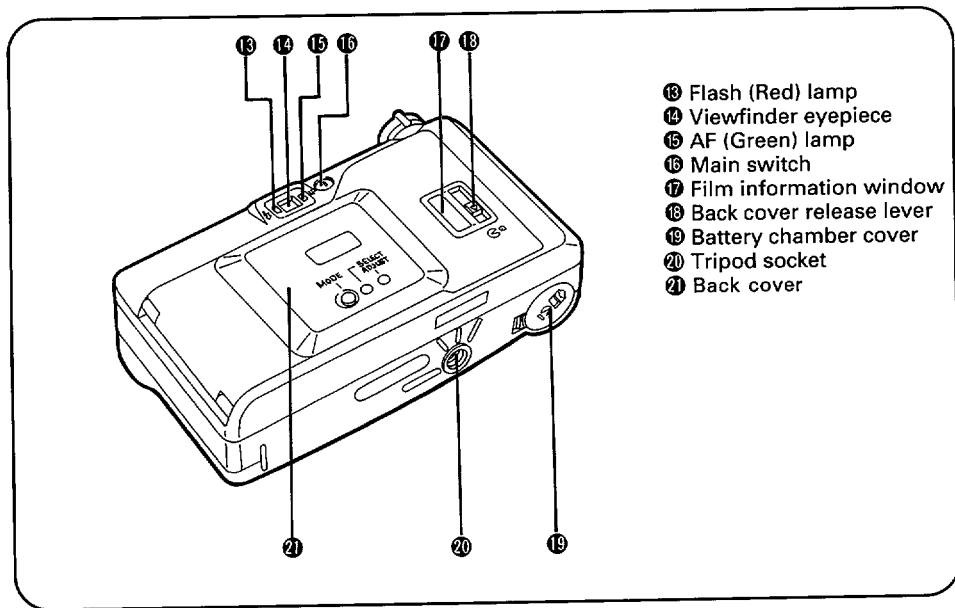

## LCD PANEL

All indications will not actually appear simultaneously as shown.

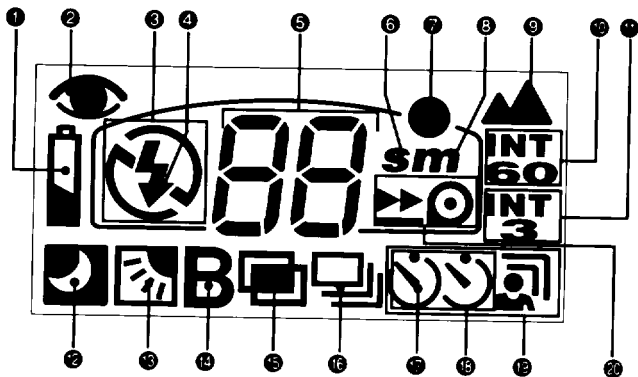

### LCD (Liquid-crystal display)

- When the LCD is exposed to a high temperature of about 60°C, it may blacken, but when the temperature falls, it will return to normal.
- The LCD may also slow down in response to lower temperatures, but this is an LCD characteristic, not a defect.

- 1 Battery Exhaustion Warning
- 2 Red-eye Reduction Flash mode
- 3 Flash-OFF mode
- 4 Flash-ON mode
- 5 Film Counter/Interval Timer
- 6 Second
- 7 Shutter Release button
- 8 Minute
- 9 Infinity-landscape mode
- 10 Interval Shooting mode (60 minutes)
- 11 Interval Shooting mode (3 minutes)
- 12 Slow Shutter Speed
- 13 Backlight Compensation mode
- 14 Bulb mode
- 15 Multi-exposure Shooting mode
- 16 Consecutive Shooting mode
- 17 Self-timer mode
- 18 Dual-Frame Self-Timer mode
- 19 Auto Tele-Wide Self-timer mode
- 20 Film Rewinding



**Asahi Optical Co., Ltd.** 11-1, Nagata-cho 1-chome, Chiyoda-ku, Tokyo 100, JAPAN  
**Pentax Europe n.v.** Weveldlaan 3-5, 1930 Zaventem, BELGIUM  
**Pentax Handelsgesellschaft mbH.** Julius-Vosseler-Strasse, 104, D-22527 Hamburg, GERMANY  
**Pentax U.K. Limited.** Pentax House, South Hill Avenue, South Harrow, Middlesex HA2 0LT, U.K.  
**Pentax France S.A.** Z.I. Argenteuil, 12, rue Ambroise Croizat, 95100 Argenteuil, FRANCE  
**Pentax Benelux** (for Netherlands) Spinveld 25, 4815 HR Breda, NETHERLANDS  
(for Belgium & Luxemburg) Weveldlaan 3-5, 1930 Zaventem, BELGIUM  
**Pentax (Schweiz) AG** Industriestrasse 2, 8305 Dietlikon, SWITZERLAND  
**Pentax Scandinavia AB** Falhagsleden 57, 75127 Uppsala, SWEDEN  
**Pentax Corporation** 35 Inverness Drive East, Englewood, Colorado 80112, U.S.A.  
**Pentax Canada Inc.** 3131 Universal Drive, Mississauga, Ontario L4X 2E5, CANADA  
**Asahi Optical Brasileira Ind. e Com. Ltda.** Rua Dr. Renato Paes de Barros, 714 CJ. 103/104 Itaim Bibi,  
São Paulo CEP 04530-001, BRAZIL



## Free Manuals Download Website

<http://myh66.com>

<http://usermanuals.us>

<http://www.somanuals.com>

<http://www.4manuals.cc>

<http://www.manual-lib.com>

<http://www.404manual.com>

<http://www.luxmanual.com>

<http://aubethermostatmanual.com>

Golf course search by state

<http://golfingnear.com>

Email search by domain

<http://emailbydomain.com>

Auto manuals search

<http://auto.somanuals.com>

TV manuals search

<http://tv.somanuals.com>