

PENTAX

EN

smc PENTAX-DA INTERCHANGEABLE LENS OPERATING MANUAL

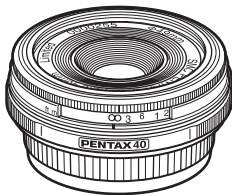
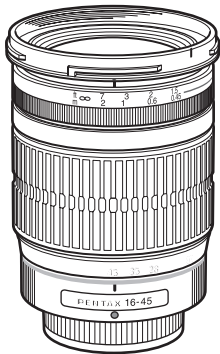

Download from Www.Somanuals.com. All Manuals Search And Download.

FOREWORD

Thank you for purchasing the smc PENTAX-DA lens.

Please read this operating manual carefully before using the lens to ensure that it is used properly. In addition, also refer to your camera operating manual.

The smc PENTAX-DA lens can be used exclusively with PENTAX digital SLR cameras. This lens is not compatible with film SLR cameras.

- In this operating manual, “smc PENTAX-DA lens” is shortened to “DA lens.”
- Illustrations shown herein may differ from the actual appearance.
- PENTAX and smc PENTAX are trademarks of HOYA CORPORATION.
- SDM is a trademark of HOYA CORPORATION.

Although we have carefully designed these lenses for safe operation, please pay special attention to items marked with the following symbols when using this product.



WARNING

This symbol indicates precautions that if not followed, could result in serious injuries to the user.



CAUTION

This symbol indicates precautions that if not followed, could result in minor or medium injuries to the user or damage to the equipment.



WARNING

- **Never look at the sun through the lens or camera for a long time. Serious damage to the retina or total loss of eyesight may occur, particularly when looking directly through the lens.**



CAUTION

- **Do not leave the lens in direct sunlight without the lens cap. Direct sunlight passing through the lens will be intensified, and should it focus on flammable materials, fire may occur.**

1. Storage and mildew prevention
 - Take the lens out of the protective case or camera bag, and store it in a dry, well-ventilated place.
 - Avoid storing the lens in a poorly ventilated location such as a closet, wardrobe, drawer, vehicle, or where insect repellent or medicine is kept.
 - Avoid storing the lens in areas of high temperature and humidity, where there is a risk of mildew growth. Store the lens with a desiccant in a dry cabinet, airtight container, or plastic bag. (Leaving a saturated desiccant in the storage container can cause damage to the lens. Be sure to read the instructions that come with the desiccant before use.)
2. Be careful when handling lenses that are not dust-proof, water-resistant, or do not have simplified weather-resistant construction in the rain, fog or environments in which sand or dust is in the air.
3. When the lens is not attached to the camera body, attach both the supplied lens cap and lens mount cap to protect it from dust, etc.
4. Never use any organic solvent such as thinner, alcohol, or benzine, etc. to remove dust on the lens.
5. The lens is a precise optical instrument. Be careful not to let it fall, or subject it to strong shocks or pressure. Use a cushion or similar pad to protect the lens from the vibrations of motorcycles or other vehicles, boats, etc.
6. Avoid subjecting the lens to rapid changes in temperature, otherwise condensation can occur on both the inside and the outside of the lens. Put the lens in a plastic bag or camera bag, and take it out after the lens has reached ambient temperature.
7. Do not leave the camera with the lens cap off attached to a tripod or other rigid camera support. The inner parts of the camera can be damaged by direct sunlight.
8. Have the lens inspected by a dealer every one or two years to maintain its high performance.

FOREWORD	
USING YOUR LENS SAFELY	1
PRECAUTIONS AND LENS MAINTENANCE	2
FEATURES OF THE smc PENTAX-DA LENS	6
About dustproof, water resistance, and simplified weather resistance	7
smc PENTAX-DA LENS	8
About the DA lens mount	9
About lenses with a supersonic motor	10
Precautions for using lenses equipped with a supersonic motor the <i>K10D</i>	11
MOUNTING AND REMOVING THE LENS	12
LENS CAP	13
Attaching the dedicated lens cap to DA 15mm f/4ED AL Limited	14
Attaching the dedicated lens cap to DA 40mm f/2.8 Limited	14
FOCUSING	15
Changing the Focus Mode	15
For the DA [*] lens	15
Using Autofocus	16
Focusing with the OK Button	16
Using Manual Focus	18
Using the Quick-Shift Focus System	18

How to use the Quick-Shift Focus System	19
DA★ 200mm f/2.8ED [IF] SDM, DA★ 300mm f/4ED [IF] SDM focusing	21
Precautions on close-distance scale	22
ZOOM LENS	23
About the zoom ring	24
MACRO LENS	25
Magnification Scale	25
ATTACHING THE LENS HOOD	26
Screw-on Type (DA 70mm f/2.4 Limited dedicated lens hood)	26
Screw-on Type (DA 40mm f/2.8 Limited dedicated lens hood)	27
Bayonet Type	27
Bayonet Type (DA 21mm f/3.2 AL Limited dedicated lens hood)	28
About the PL filter window	29
Built-in lens hood	31
FILTERS	32
Precaution on filters	32
Attaching the 30.5mm filter to the DA 40mm f/2.8 Limited lens	32
Attaching a filter and the dedicated lens hood to the DA 21mm f/3.2 AL Limited lens	33
Attaching a filter and the dedicated lens hood to the DA 70mm f/2.4 Limited lens	34

Circular polarizing filters and vignetting	35
Compatibility table for PENTAX circular polarizing filters	36
PRECAUTIONS WHEN USING THE LENS WITH A FLASH	40
Built-in Flash	40
External Flash	40
Compatibility of DA Lenses with the Built-in Flash	42
TRIPOD MOUNT	45
Removing the Tripod Mount	46
MAIN SPECIFICATIONS	47

- The smc PENTAX-DA lens is an interchangeable lens specifically designed for digital cameras. Its image circle is specialized for image sensors in PENTAX digital SLR cameras and its optical system is optimized for the characteristics of digital images.
- When autofocusing is finished, it is possible to make fine adjustments by hand using the “Quick-Shift Focus System” (see page 19 for details).
- Lenses that have “SDM” in their name are equipped with a supersonic motor. When mounted on a camera that supports supersonic motors, the autofocus is quiet and smooth.
- The DA[★] 55mm f/1.4 SDM uses a circular aperture. Using it when stopping down from full aperture to about f/2.8 keeps light sources and other fuzzy points perfectly round.

About dustproof, water resistance, and simplified weather resistance

- **Dust-proof and water-resistant lenses**

DA[★] 55mm f/1.4 SDM, DA[★] 300mm f/4ED [IF] SDM, DA[★] 200mm f/2.8ED [IF] SDM, DA[★] 16-50mm f/2.8ED AL [IF] SDM, DA[★] 50-135mm f/2.8ED [IF] SDM, DA[★] 60-250mm f/4ED [IF]SDM

These DA[★] lenses are dust-proof and water-resistant because each part is individually sealed. This makes it difficult for dust and water to enter the lens.

- **Lenses with simplified weather-resistant construction**

DA 18-55mm f/3.5-5.6 AL WR, DA 50-200mm f/4-5.6ED WR

These lenses are made with a simplified weather-resistant construction by using DA[★] lens sealing technology which makes it difficult for water to enter the lens.

smc PENTAX-DA LENS

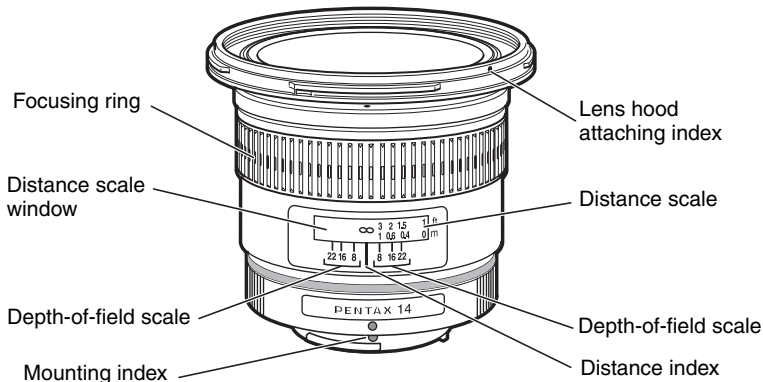
**Note:**

- The DA lens does not have an aperture ring. Aperture settings are controlled automatically as if set to the auto "A" position, so accessories without an auto "A" setting cannot be used with this lens.
- The DA lens is not compatible with film SLR cameras.

About the DA lens mount

The DA lens is an interchangeable lens specifically designed for PENTAX digital SLR cameras. There are three mounts for the DA lens, the K_{AF}, K_{AF2} and K_{AF3}.

K_{AF}-mount

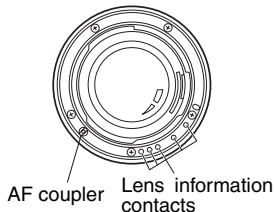

K_{AF2}-mount

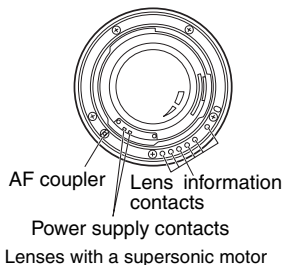

K_{AF3}-mount

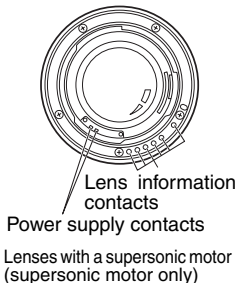

Refer to the next page for more information on lenses with supersonic motors.

CAUTION

Be careful not to damage or dirty the lens mount surfaces as this can result in failure or malfunction.

About lenses with a supersonic motor

The lenses in the table below are equipped with internal supersonic motors. When mounted on a camera body that supports supersonic motors, the autofocus (AF) is quiet and smooth.

- **Supersonic motor compatible camera body**

K-m / K2000, K20D, K200D, K10D*, K100D Super

* If the firmware is version 1.30 or later, refer to page 11.

Lens	Precautions
DA* 55mm f/1.4 SDM DA17-70mm f/4 AL [IF] SDM	<ul style="list-style-type: none"> • The lens uses a supersonic motor. When the lens is mounted on a camera body that does not support supersonic motors (including the <i>K10D</i> with firmware older than version 1.30), the autofocus cannot be operated by either the AF motor in the camera body or the supersonic motor. • If using the lens with the following cameras, and the power is turned on, MF appears in the monitor, but it does not interfere with AF operations. <i>K10D, K100D Super, K20D, K200D</i>
DA* 60-250mm f/4ED [IF] SDM DA* 16-50mm f/2.8ED AL [IF] SDM DA* 50-135mm f/2.8ED [IF] SDM DA* 200mm f/2.8ED [IF] SDM DA* 300mm f/4ED [IF] SDM	When the lens is mounted on a camera body that does not support supersonic motors (including the <i>K10D</i> with firmware older than version 1.30), the autofocus is operated by the AF motor in the camera body.

* In both cases focusing can be done manually.

Precautions for using lenses equipped with a supersonic motor on the *K10D*

When using lenses equipped with a supersonic motor on the *K10D*, use camera firmware version 1.30 or later.

- **How to Check and Update the Firmware**

Holding-down the MENU button while turning ON the *K10D* will display the firmware version in the center of the display.

Download and install the firmware update for the *K10D* using the link below.

- **Firmware Download Page:**

http://www.pentax.jp/english/support/download_digital.html

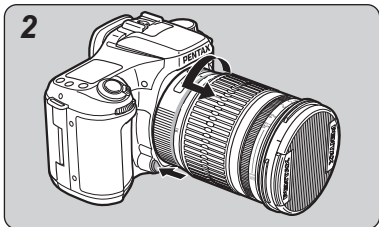
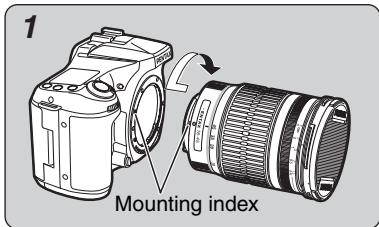

1. To mount the lens on the camera body

Attach the lens while aligning the red dots on the lens and body, then turn the lens clockwise until it clicks in place.

Memo:

- Do not hold down the lens unlock button while mounting the lens, otherwise the lens will not be properly mounted.
- After mounting the lens, gently turn the lens counterclockwise to make sure it is locked in place.

2. To remove the lens

Hold down the lens unlock button on the camera body and turn the lens counterclockwise.

Download from Www.Somanuals.com. All Manuals Search And Download.

Take off the lens cap by pressing the two tabs inward.

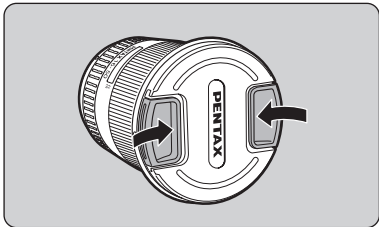
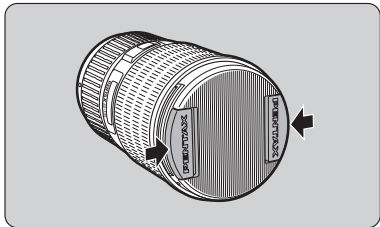

Memo:

- When not using the lens, be sure to attach the lens cap.
- Attach the dedicated lens cap over the lens hood on the DA 21mm f/3.2 AL Limited, DA 35mm f/2.8 Macro Limited, DA FISH-EYE 10-17mm f/3.5-4.5ED [IF], and DA 70mm f/2.4 Limited. Also, with the DA 21mm f/3.2 AL Limited, DA 40mm f/2.8 Limited, and DA 70mm f/2.4 Limited, it is possible to mount the F49mm lens cap (option) by removing the lens hood.

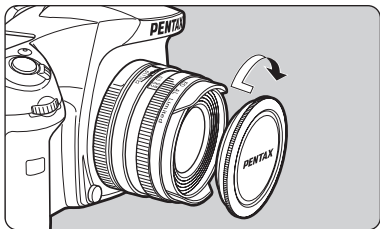

Attaching the dedicated lens cap to DA 15mm f/4ED AL Limited

Screw the lens cap to the front of the lens.

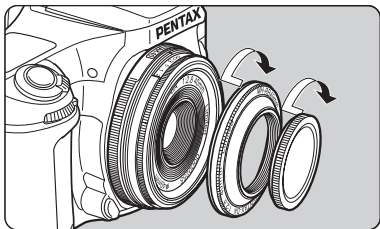

Attaching the dedicated lens cap to DA 40mm f/2.8 Limited

First screw the dedicated hood to the front of the lens, then screw the lens cap to the lens hood.

Changing the Focus Mode

Use the camera's focus mode switch to change between autofocus mode and manual focus mode. For details, refer to your camera operating manual.

For the DA[★] lens

The focus mode switch on the DA[★] lens is used to change between the autofocus and manual focus modes (the focus mode switch on the camera is always set to autofocus).

To use the autofocus, set the switch to the AF position.

To use the manual focus, set the switch to the MF position.

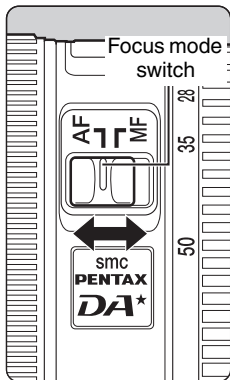

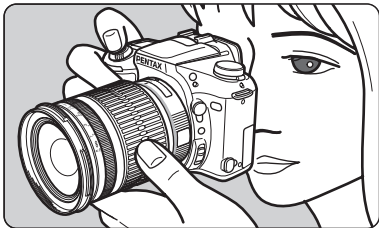

Using Autofocus

Set the focus mode to autofocus. Press the shutter release button halfway to autofocus. With the *K20D*, *K10D*, **istD* or *K-m / K2000* cameras, you can also press the AF button to autofocus.

See page 15 for information about changing the focus mode.

Focusing with the OK Button

With the *K200D*, *K100D Super*, *K110D*, *K100D*, **istDL2*, **istDS2*, **istDL*, and **istDS*, you can configure the camera's custom settings to disable autofocusing when pressing the shutter release button halfway and enable focusing by pressing the OK button.

Memo:

- For details on the setting procedures, refer to *Manuals Separating Download*.

CAUTION

During autofocus, the focusing ring of the following lenses will rotate.

- **To prevent malfunction, do not touch the focusing ring during autofocus. Particularly be careful when the Focus Mode is set to AF.C (AF-continuous). The camera continues adjusting the focus while the AF button is pressed or the shutter release button is pressed halfway.**

- DA FISH-EYE 10-17mm f/3.5-4.5ED [IF]
- DA 12-24mm f/4ED AL [IF]
- DA 16-45mm f/4ED AL
- DA 17-70mm f/4 AL [IF] SDM
- DA 18-55mm f/3.5-5.6 AL WR
- DA L 18-55mm f/3.5-5.6 AL
- DA 50-200mm f/4-5.6ED WR
- DA L 50-200mm f/4-5.6ED
- DA 55-300mm f/4-5.8ED
- DA 15mm f/4ED AL Limited
- DA 21mm f/3.2 AL Limited
- DA 35mm f/2.8 Macro Limited
- DA 40mm f/2.8 Limited
- DA 70mm f/2.4 Limited

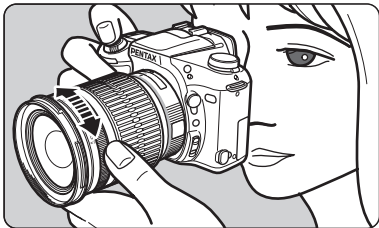

Using Manual Focus

Set the focus mode to MF, and turn the focusing ring to focus manually. See page 15 for information about changing the focus mode.

Using the Quick-Shift Focus System

If the focus mode is set to autofocus, you can focus manually after autofocus is achieved. Manually turn the focusing ring to finely adjust the focus. You can do this without changing the focus mode to MF.

The Quick Shift Focus System is not available with the following lenses.

- DA L 18-55mm f/3.5-5.6 AL

- DA L 50-200mm f/4-5.6ED

How to use the Quick-Shift Focus System

1. Using Autofocus

Set the focus mode switch to autofocus, then press the shutter release button halfway to autofocus.

With the *K20D*, *K10D*, **istD* or *K-m / K2000* cameras, you can also press the AF button to focus.

With the *K200D*, *K100D Super*, *K110D*, *K100D*, **istDL2*, **istDS2*, **istDL* or **istDS* cameras set as explained in “Focusing with the OK Button” on page 16, you can focus by pressing the OK button.

- 2. Hold down the shutter release button halfway (or hold down the AF button or OK button), then turn the focusing ring to finely adjust focus.**
- 3. Finally, press the shutter release button fully to take a picture.**

The focusing ring on some lenses may rotate during autofocus.

- Do not touch the focusing ring while autofocus is operating as it may cause a malfunction. For more information see the “CAUTION” on page 17.

CAUTION

- When using the Quick-Shift Focus System, keep pressing the shutter release button (or AF button) after you achieve focus and before taking a picture. If you let go of the shutter release button before taking the picture, autofocus will operate again when you press the shutter release button again.
However, by configuring the camera's custom settings, you can take pictures without autofocusing after letting go of the shutter release button. See the camera operating manual for details about the setting procedure.
- When focusing with manual focus or the Quick-Shift Focus System, the mechanism allows the focusing ring to rotate freely after it is set to the ∞ (infinity) or the minimum focus distance ends. However do not attempt to rotate it any farther than these ends as this will result in decreased performance.
 - DA 14mm f/2.8ED [IF]
 - DA[★] 200mm f/2.8ED [IF] SDM
 - DA[★] 16-50mm f/2.8ED AL [IF] SDM
 - DA[★] 60-250mm f/4ED [IF] SDM
 - DA[★] 55mm f/1.4 SDM
 - DA[★] 300mm f/4ED [IF] SDM
 - DA[★] 50-135mm f/2.8ED [IF] SDM

DA★ 200mm f/2.8ED [IF] SDM, DA★ 300mm f/4ED [IF] SDM focusing

- The mechanism does not allow the angle of rotation of the focusing ring and the distance scale to align while focusing. Always check the focus using the view finder before taking a picture. This is especially true with manual focus and the Quick-Shift Focus System.

Precautions on close-distance scale

(For DA 16-45mm f/4ED AL, DA 18-55mm f/3.5-5.6 AL WR, DA L 18-55mm f/3.5-5.6 AL)

In the close-distance scale range (minimum focus distance range), when shooting at the maximum aperture, image quality in the corners of the picture may deteriorate because of the optical characteristics of the lens.

When taking a picture in this range, we recommend that you use a smaller aperture, stopping down from full aperture.

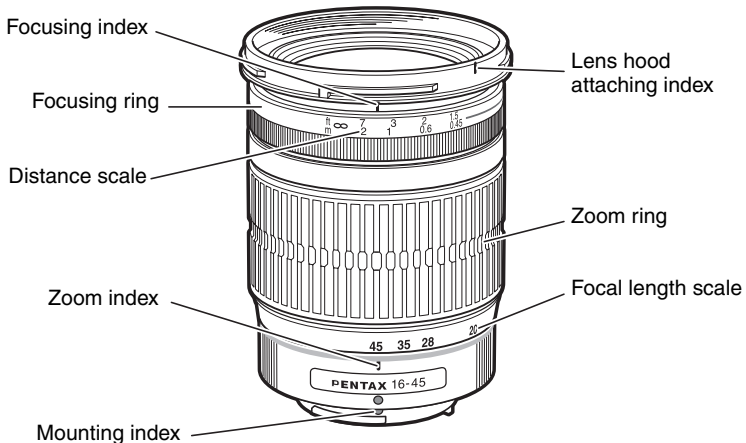

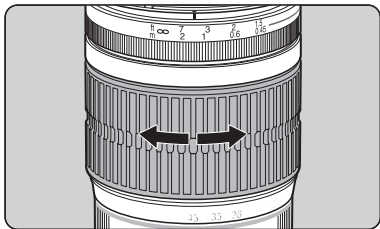

The zoom lens has a focusing ring on the front side and a zoom ring on the rear side. Turn the zoom ring to set the desired angle of view (lens focal length).

Memo:

- The focusing point may shift slightly by changing the focal length. First adjust the zoom and then adjust the focus.
- The focusing index on the zoom lens is set to match the focus point when the focal length is at telephoto. The focusing index may not match the focus point for other focal lengths.

About the zoom ring

Turn the zoom ring clockwise for telephoto and counterclockwise for wide-angle.

Download from Www.Somanuals.com. All Manuals Search And Download.

DA 35mm f/2.8 Macro Limited lens adjust focus from infinity to life-size [1x].

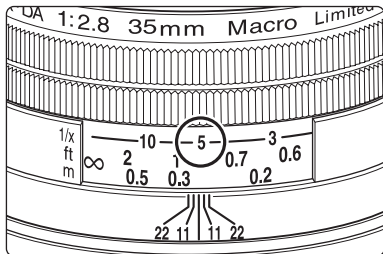

Magnification Scale

The magnification is indicated by denominators on the distance scale. "5" indicates "1/5x". When determining the magnification first, set the magnification in the manual focus mode and adjust focus by moving the camera closer or further from the subject.

ATTACHING THE LENS HOOD

In order to avoid deterioration in image quality from internal reflection, use of a lens hood is recommended.



a. Screw-on Type (DA 70mm f/2.4 Limited dedicated lens hood)

Screw the hood on to the front of the lens to attach it.

The hood is telescopic. Extend it fully to use it.

Memo:

The lens hood cannot be mounted on some circular polarizing filters that are not produced by PENTAX.

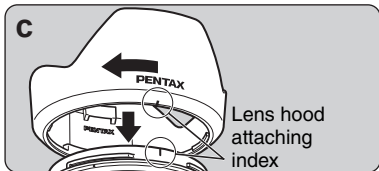
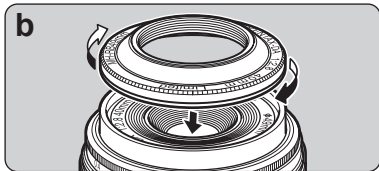

b. Screw-on Type (DA 40mm f/2.8 Limited dedicated lens hood)

Screw the hood on to the front of the lens to attach it.

c. Bayonet Type

When attaching the lens hood, align the index on the lens hood with the attaching index on the lens, and push both parts straight toward each other. Attach the lens hood on the lens by turning the hood in the clockwise direction, as viewed from the front of the lens, to lock it until it clicks into position.

Memo:

- When attaching the lens hood, hold the focusing ring and zoom ring securely to prevent them from turning.
- When the lens hood is not in use, it can also be turned around and attached in the reversed position.

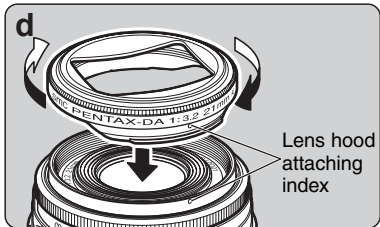

d. Bayonet Type (DA 21mm f/3.2 AL Limited dedicated lens hood)

When attaching the lens hood, align the index on the lens hood with the attaching index on the lens, and push both parts straight toward each other. Attach the lens hood on the lens by turning the hood in a clockwise direction, as seen from the front of the lens, until it stops.

Memo:

- Vignetting occurs if the camera is used while the hood is not completely attached.
- The dedicated lens hood cannot be attached if a filter is attached to the front of the lens. To use a filter and the dedicated lens hood together, attach a 43mm diameter filter to the back of the hood. (Refer to page 33)

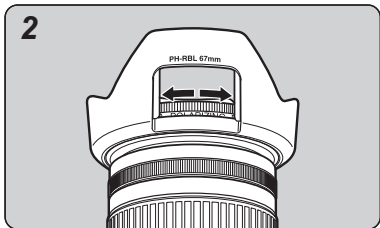
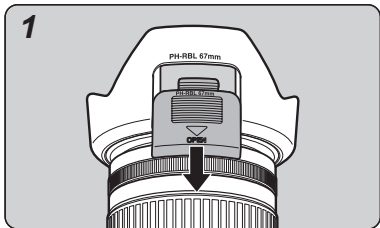

About the PL filter window

A PL filter window is attached to the bayonet-type hood included with the lenses below to make manipulating the polarizing filter easier.

- DA[★] 55mm f/1.4 SDM
- DA[★] 16-50mm f/2.8ED AL [IF] SDM
- DA 18-55mm f/3.5-5.6 AL WR
- DA[★] 60-250mm f/4ED [IF] SDM
- DA 55-300mm f/4-5.8ED
- DA[★] 300mm f/4ED [IF] SDM
- DA 16-45mm f/4ED AL
- DA 17-70mm f/4AL [IF] SDM
- DA[★] 50-135mm f/2.8ED [IF] SDM
- DA 50-200mm f/4-5.6ED WR
- DA[★] 200mm f/2.8ED [IF] SDM

CAUTION

The PL filter window cap of the DA[★] 55mm f/1.4 SDM cannot be attached or removed with the hood attached to the lens. Remove the hood from the lens to attach or remove the window cap.

How to use the lens hood with polarizing filter window

1. Remove the PL filter window cap by sliding it in the direction as shown above.
2. Turn the outer rim of the circular polarizing filter from the PL filter window as shown above.

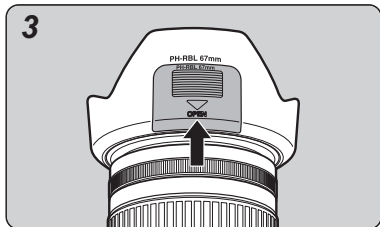

3. Attach the PL filter window cap.

Memo:

- When shooting, be sure the PL filter window cap is in place to use the lens hood to maximum effect.

Built-in lens hood

The following lenses have a lens hood built into the lens body. The hood cannot be removed from the lens.

- DA FISH-EYE 10-17mm f/3.5-4.5ED [IF]
- DA 35mm f/2.8 Macro Limited (*), DA 15mm f/4ED AL Limited (*)

Lenses marked with an * have a built-in sliding hood which should be extended.

Make sure the filter size matches the lens, then screw the filter onto the front of the lens.

 **Memo:**

- The compatible filter size for each lens is listed on pages 47-53.
- Filters cannot be mounted on the DA FISH-EYE 10-17mm f/3.5-4.5ED [IF].

Precaution on filters

- Since a filter becomes a part of the optical system when attached to the lens, handle it in the same way you handle the lens with care to dust, dirt and scratches. Normally, attaching two or more filters on a lens does more harm than good. However, attaching a circular polarizing filter and another filter is not a problem.
- Use a circular polarizing filter with an autofocus camera for proper exposure and autofocusing.

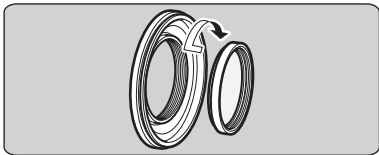

Attaching the 30.5mm filter to the DA 40mm f/2.8 Limited lens

Normally, you attach the 49mm filter to the front of the lens. But you can also screw a 30.5mm filter to the back of the dedicated hood.

Download from Www.Somanuals.com. All Manuals Search And Download.

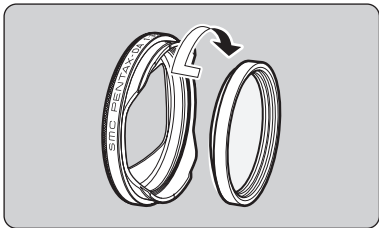

Attaching a filter and the dedicated lens hood to the DA 21mm f/3.2 AL Limited lens

It is possible to attach a 49mm diameter filter to the front of the DA 21mm f/3.2 AL Limited lens, but not when the dedicated lens hood is attached. To use a filter with the dedicated lens hood, screw a 43mm diameter filter to the back of the filter.

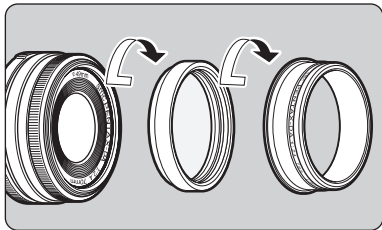

Attaching a filter and the dedicated lens hood to the DA 70mm f/2.4 Limited lens

With the DA 70mm f/2.4 Limited lens, attach the 49mm diameter filter to the front of the lens. To use it together with the dedicated lens hood, screw it on over the filter that is attached.

Memo:

- The lens hood cannot be mounted on some circular polarizing filters that are not produced by PENTAX.

Circular polarizing filters and vignetting

Circular polarizing filters are thicker than regular filters. Depending on the lens that is mounted and the shooting conditions, vignetting may occur in the four corners of the image. Refer to the “Compatibility table for PENTAX circular polarizing filters” on the following page for information on compatibility of PENTAX circular polarizing filters (currently not in production) with various lenses. There are two types of PENTAX circular polarizing filters. The A type (on the left in the diagram below) and the B type (on the right in the diagram below). The B type filter is thinner than the A type filter.

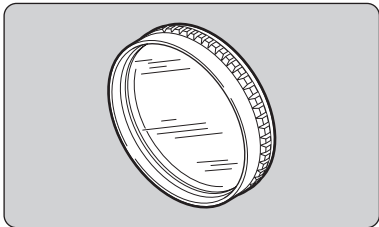

A type

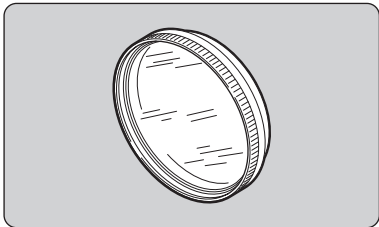

B type

Compatibility table for PENTAX circular polarizing filters

* PENTAX circular polarizing filters are currently not produced.

YES: Compatible *YES: Compatible in some conditions NO: Incompatible

Lens	Circular polarizing filter (A type)		Circular polarizing filter (B type)	
	Compatibility	Notes	Compatibility	Notes
DA 14mm f/2.8ED [IF]	NO	Vignetting occurs.	YES	
DA 15mm f/4ED AL Limited	NO	Vignetting occurs.	YES	
DA 21mm f/3.2 AL Limited* ³	YES	Use a filter with a diameter of 49mm.	YES	Use a filter with a diameter of 49mm.
DA 35mm f/2.8 Macro Limited	*YES	*Can be mounted and used. However, the built-in lens hood cannot be withdrawn while the A type circular polarizing filter is attached.	YES	
DA 40mm f/2.8 Limited* ¹	YES	Use a filter with a diameter of 49mm.	YES	Use a filter with a diameter of 49mm.
DA* 55mm f/1.4 SDM* ¹	YES		YES	
DA 70mm f/2.4 Limited* ¹	YES		YES	

Lens	Circular polarizing filter (A type)		Circular polarizing filter (B type)	
	Compatibility	Notes	Compatibility	Notes
DA★ 200mm f/2.8ED [IF] SDM	*YES	*Can be mounted and used. However, the dedicated bayonet hood cannot be mounted on top of the A type circular polarizing filter.	YES	
DA★ 300mm f/4ED [IF] SDM				
DA 12-24mm f/4ED AL [IF]*2	*YES	*Vignetting occurs at focal lengths below 15mm.	*YES	*Vignetting occurs at focal lengths below 15mm.
DA★ 16-50mm f/2.8ED AL [IF] SDM	NO	Vignetting occurs.	YES	
DA★ 50-135mm f/2.8ED [IF] SDM	YES		YES	
DA 16-45mm f/4ED AL	*YES	*Can be mounted and used. However, the dedicated bayonet hood cannot be mounted on top of the A type circular polarizing filter.	YES	
DA 17-70mm f/4 AL [IF] SDM	NO		*YES	Vignetting occurs when the focal length is 17mm.

Lens	Circular polarizing filter (A type)		Circular polarizing filter (B type)	
	Compatibility	Notes	Compatibility	Notes
DA L 18-55mm f/3.5-5.6 AL	*YES	*Can be mounted and used. However, the dedicated bayonet hood cannot be mounted on top of the A type circular polarizing filter.	YES	
DA 18-55mm f/3.5-5.6 AL WR				
DA L 50-200mm f/4-5.6ED				
DA 50-200mm f/4-5.6ED WR				
DA 55-300mm f/4-5.8ED				
DA [*] 60-250mm f/4ED [IF] SDM	YES		YES	

- *1 The lens hood cannot be mounted on some circular polarizing filters that are not produced by PENTAX.
- *2 Vignetting occurs at focal lengths below 15mm with other PENTAX filters (such as the Skylight) besides circular polarizing filters.
- *3 The dedicated hood cannot be mounted if a filter including a circular polarizing filter is mounted on the front of the lens.

 **Memo:**

- Filters, including circular polarizing filters, cannot be mounted on the DA FISH-EYE 10-17mm f/3.5-4.5ED [IF] lens.

Built-in Flash

The built-in flash can not be used when the distance is less than 0.7m. When the flash is used within 0.7m, it causes incorrect exposure control and vignetting in the picture corners.

- Refer to the “Compatibility of DA Lenses with the Built-in Flash” chart on page 42 for information on the compatibility of the built-in flash with the lens being used.

External Flash

The external flash can be used while the lens hood is attached. However, the following conditions apply to some types of lenses.

●DA 14mm f/2.8ED [IF]

●DA 15mm f/4ED AL Limited

The AF540FGZ and AF360FGZ external flash units can only be used when the wide-angle panel is used (it is also possible to use the lens hood). Other external flash units are not recommended because their coverage angle is not compatible with the angle of view of the lens.

●DA 21mm f/3.2 AL Limited

External flash units can be used while the lens hood is mounted without problems if it is possible to set their zoom [coverage angle] up to 28mm.

●DA FISH-EYE 10-17mm f/3.5-4.5ED [IF]

External flash units cannot be used because their coverage angle is not compatible with the angle of view of the lens.

●DA 12-24mm f/4ED AL [IF]

PENTAX external flash units which cover a 24mm lens on a 35mm SLR, or 16mm lens on a digital SLR, can be used when the lens is set from 16mm to 24mm.

AF540FGZ and AF360FGZ can be used from 13mm to 24mm with the wide angle panel (in both cases, it is possible to use the lens hood). Please note that at focal lengths less than 13mm the corners of the picture will not be fully illuminated.

Other external flash units are not recommended, because their coverage angle is not wide enough to cover the angle of view of the lens.

●DA★ 16-50mm f/2.8ED AL [IF] SDM**●DA 16-45mm f/4ED AL**

PENTAX external flash units which cover a 24mm lens on a 35mm SLR, or 16mm lens on a digital SLR, can be used with the lens hood without problems.

* For more information, refer to the manual for the external flash unit.

Compatibility of DA Lenses with the Built-in Flash

Lens	Compatibility			
	<i>*istD</i>	<i>*istDS</i> , <i>*istDS2</i> <i>*istDL</i> , <i>*istDL2</i>	<i>K-m / K2000</i> , <i>K200D</i> , <i>K100D Super</i> , <i>K110D</i> , <i>K100D</i>	<i>K20D</i> , <i>K10D</i>
DA 14mm f/2.8ED [IF]	NO	NO	NO	NO
DA 15mm f/4ED AL Limited	NO	NO	NO	NO
DA 21mm f/3.2 AL Limited	YES	YES	YES	YES
DA 35mm f/2.8 Macro Limited	YES	YES	YES	YES
DA 40mm f/2.8 Limited	YES	YES	YES	YES
DA* 55mm f/1.4 SDM	YES	YES	YES	YES
DA 70mm f/2.4 Limited	YES	YES	YES	YES
DA* 200mm f/2.8ED [IF] SDM	YES	YES	YES	YES
DA* 300mm f/4ED [IF] SDM	YES	YES	YES	YES
DA FISH-EYE 10-17mm f/3.5-4.5ED [IF]	NO	NO	NO	NO
DA 12-24mm f/4ED AL [IF]	NO	NO	NO	NO
DA* 16-50mm f/2.8ED AL [IF] SDM	YES*1	YES*2	YES*3	YES*3
DA 16-45mm f/4ED AL	YES*4	YES*4	YES*4	YES*4
DA 17-70mm f/4 AL [IF] SDM	YES*5	YES*6	YES*7	YES*7
DA L 18-55mm f/3.5-5.6 AL	YES	YES	YES	YES

Lens	Compatibility			
	<i>*istD</i>	<i>*istDS, *istDS2 *istDL, *istDL2</i>	<i>K-m / K2000, K200D, K100D Super, K110D, K100D</i>	<i>K20D, K10D</i>
DA 18-55mm f/3.5-5.6 AL WR	YES	YES	YES	YES
DA [*] 50-135mm f/2.8ED [IF] SDM	YES	YES	YES	YES
DA L 50-200mm f/4-5.6ED	YES	YES	YES	YES
DA 50-200mm f/4-5.6ED WR	YES	YES	YES	YES
DA 55-300mm f/4-5.8ED	YES	YES	YES	YES
DA [*] 60-250mm f/4ED [IF] SDM	YES	YES	YES	YES

Except for the DA 35mm f/2.8 Macro Limited, DA 70mm f/2.4 Limited, DA 40mm f/2.8 Limited and DA 21mm f/3.2 AL Limited lenses, do not use the lens hood when using the built-in flash. This is to prevent the lens hood from obstructing the flash.

- *1 Vignetting occurs when the focal length is 35mm or less, or when the focal length is 16 to 50mm and the shooting distance is below 1.5 m.
- *2 Vignetting occurs when the focal length is 28mm or less, or when the focal length is 16 to 50mm and the shooting distance is below 1.5 m.
- *3 Vignetting occurs when the focal length is 20mm or less, or when the focal length is 35mm and the shooting distance is below 1.5 m.
- *4 Vignetting occurs when the focal length is below 28mm, or when the focal length is 28mm and the shooting distance is 1 m or less.

- *5 Vignetting occurs when the focal length is below 35mm, or when the focal length is 35mm and the shooting distance is 1 m or less.
- *6 Vignetting occurs when the focal length is below 35mm.
- *7 Vignetting occurs when the focal length is below 24mm, or when the focal length is 24mm and the shooting distance is 1 m or less.

DA* 60-250mm f/4ED [IF] SDM and DA* 300mm f/4ED [IF] SDM are equipped with the tripod mount. To position the camera vertically or horizontally, loosen the camera position shift lock screw, turn the camera 90° to the right or left as desired, and tighten the lock screw firmly.

The tripod mount is detachable.

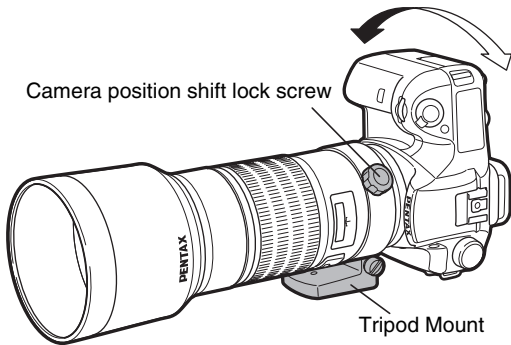

- Attach only to a stable tripod.
- We recommend using a fast shutter speed as large lenses may contribute to camera shake.

Removing the Tripod Mount

To remove the mount, use a coin to loosen the screw by turning it to the left. Be careful not to loosen the screw too much or else it may fall out.

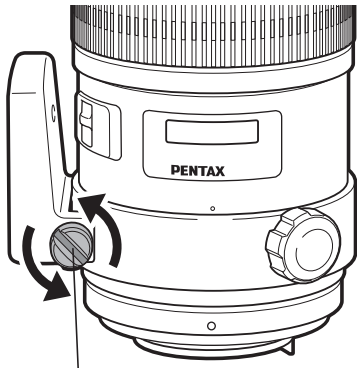

Insert a coin into the slot on the screw and turn to the left.

- * For use with any PENTAX digital SLR camera.
- * AL = Uses an aspheric lens, ED = Lens made with extra-low dispersion glass, IF = Inner focus-type lens, SDM = Lens with a supersonic motor

Lens	DA 14mm f/2.8ED [IF]	DA 15mm f/4ED AL Limited	DA 21mm f/3.2 AL Limited
Focal length	14mm (equivalent to approx. 21.5mm in 35mm format)	15mm (equivalent to approx. 23mm in 35mm format)	21mm (equivalent to approx. 32mm in 35mm format)
Elements in groups	12-11	8-6	8-5
Angle of view	90°	86°	68°
Aperture	f/2.8	f/4	f/3.2
Minimum aperture	f/22	f/22	f/22
Mount type	K _{AF} -mount	K _{AF} -mount	K _{AF} -mount
Minimum focus distance	0.17m (0.56ft)	0.18m (0.59ft)	0.2m (0.66ft)
Maximum magnification	Approx. 0.19×	Approx. 0.15×	Approx. 0.17×
Filter size	77mm	49mm	49mm or 43mm
Lens hood	PH-RBH 77mm	Built-in	MH-RBA 43mm
Max. diameter x length	83.5mm x 69mm (3.3in x 2.7in)	63mm x 39.5mm (2.5in x 1.6in)	63mm x 25mm (2.5in x 1.0in)
Weight	Approx. 420g/14.8oz (with hood approx. 455g/ 16.0oz)	Approx. 190g/6.7oz	Approx. 140g/4.9oz (with hood approx. 155g/ 5.5oz)
Soft case	S100-120	Soft case DA70	Dedicated case

Lens	DA 35mm f/2.8 Macro Limited	DA 40mm f/2.8 Limited	DA [*] 55mm f/1.4 SDM
Focal length	35mm (equivalent to approx. 53.5mm in 35mm format)	40mm (equivalent to approx. 61mm in 35mm format)	55mm (equivalent to approx. 84.5mm in 35mm format)
Elements in groups	9-8	5-4	9-8
Angle of view	44°	39°	29°
Aperture	f/2.8	f/2.8	f/1.4
Minimum aperture	f/22	f/22	f/22
Mount type	K _{AF} -mount	K _{AF} -mount	K _{AF3} -mount
Minimum focus distance	0.139m (0.46ft)	0.4m (1.31ft)	0.45m (1.48ft)
Maximum magnification	Approx. 1.00x	Approx. 0.13x	Approx. 0.17x
Filter size	49mm	49mm or 30.5mm	58mm
Lens hood	Built-in	MH-RC 49mm	PH-RBH 58mm
Max. diameter × length	63mm × 46.5mm (2.5in × 1.8in)	63mm × 15mm (2.5in × 0.6in)	70.5mm × 66mm (2.8in × 2.6in)
Weight	Approx. 215g/7.6oz	Approx. 90g/3.2oz (with hood approx. 100g/ 3.5oz)	Approx. 375g/13.2oz (with hood approx. 420g/ 14.8oz)
Soft case	Soft case DA70	Dedicated case	S90-100

Lens	DA 70mm f/2.4 Limited	DA* 200mm f/2.8ED [IF] SDM	DA* 300mm f/4ED [IF] SDM
Focal length	70mm (equivalent to approx. 107mm in 35mm format)	200mm (equivalent to approx. 307mm in 35mm format)	300mm (equivalent to approx. 460mm in 35mm format)
Elements in groups	6-5	9-8	8-6
Angle of view	23°	8.1°	5.4°
Aperture	f/2.4	f/2.8	f/4
Minimum aperture	f/22	f/22	f/32
Mount type	K _{AF} -mount	K _{AF2} -mount	K _{AF2} -mount
Minimum focus distance	0.7m (2.3ft)	1.2m (4ft)	1.4m (4.67ft)
Maximum magnification	Approx. 0.12x	Approx. 0.20x	Approx. 0.24x
Filter size	49mm	77mm	77mm
Lens hood	MH-RD 49mm	PH-RBK 77mm	PH-RBK 77mm
Max. diameter x length	63mm x 26mm (2.5in x 1.0in)	83mm x 134mm (3.3in x 5.3in)	83mm x 184mm (3.3in x 7.2in)
Weight	Approx. 130g/4.6oz (with hood approx. 150g/ 5.3oz)	Approx. 825g/29.1oz (with hood approx. 915g/ 32.3oz)	Approx. 1070g/37.7oz (with hood approx. 1160g/ 40.9oz) (with hood + tripod attachment approx. 1240g/43.7oz)
Soft case	Soft case DA70	S120-160	S120-210

Lens	DA FISH-EYE 10-17mm f/3.5-4.5ED [IF]	DA 12-24mm f/4ED AL [IF]	DA 16-45mm f/4ED AL
Focal length	10-17mm (35mm conversion not possible)	12-24mm (equivalent to approx. 18.5-37mm in 35mm format)	16-45mm (equivalent to approx. 24.5-69mm in 35mm format)
Elements in groups	10-8	13-11	13-10
Angle of view	180°-100°	99°-61°	83°-35°
Aperture	f/3.5-f/4.5	f/4	f/4
Minimum aperture	f/22-f/32	f/22	f/22
Mount type	K _{AF} -mount	K _{AF} -mount	K _{AF} -mount
Minimum focus distance	0.14m (0.46ft) (Approximately 2.5cm from front of lens)	0.3m (0.98ft)	0.28m (0.92ft)
Maximum magnification	Approx. 0.39x	Approx. 0.12x	Approx. 0.26x
Filter size	Cannot be mounted	77mm	67mm
Lens hood	Built-in	PH-RBI 77mm	PH-RBL 67mm
Max. diameter x length	68mm x 71.5mm (2.7in x 2.8in)	84mm x 87.5mm (3.3in x 3.4in)	72mm x 92mm (2.8in x 3.6in)
Weight	Approx. 320g/11.3oz	Approx. 430g/15.2oz (with hood approx. 457g/ 16.1oz)	Approx. 365g/12.9oz (with hood approx. 390g/ 13.8oz)
Soft case	S80-80	S100-120	S90-140

Lens	DA* 16-50mm f/2.8ED AL [IF] SDM	DA 17-70mm f/4 AL [IF] SDM	DA L 18-55mm f/3.5-5.6 AL
Focal length	16-50mm (equivalent to approx. 24.5-76.5mm in 35mm format)	17-70mm (equivalent to approx. 26-107mm in 35mm format)	18-55mm (equivalent to approx. 27.5-84.5mm in 35mm format)
Elements in groups	15-12	17-12	11-8
Angle of view	83°-31.5°	79°-23°	76°-29°
Aperture	f/2.8	f/4	f/3.5-5.6
Minimum aperture	f/22	f/22	f/22-38
Mount type	KAF ₂ -mount	KAF ₃ -mount	KAF-mount
Minimum focus distance	0.3m (0.98ft)	0.28m (0.92ft)	0.25m (0.82ft)
Maximum magnification	Approx. 0.21x	Approx. 0.31x	Approx. 0.34x
Filter size	77mm	67mm	52mm
Lens hood	PH-RBJ 77mm	PH-RBM 67mm	PH-RBA 52mm (sold separately)
Max. diameter x length	84mm x 98.5mm (3.3in x 3.9in)	75mm x 93.5mm (3.0in x 3.7in)	68mm x 67.5mm (2.7in x 2.7in)
Weight	Approx. 565g/19.9oz (with hood approx. 600g/21.2oz)	Approx. 485g/17.1oz (with hood approx. 515g/18.2oz)	Approx. 200g/7.1oz (with hood approx. 225g/7.9oz)
Soft case	S100-140	S90-140	S80-120

Lens	DA 18-55mm f/3.5-5.6 AL WR	DA [*] 50-135mm f/2.8ED [IF] SDM	DA L 50-200mm f/4-5.6ED
Focal length	18-55mm (equivalent to approx. 27.5-84.5mm in 35mm format)	50-135mm (equivalent to approx. 76.5-207mm in 35mm format)	50-200mm (equivalent to approx. 76.5-307mm in 35mm format)
Elements in groups	11-8	18-14	11-10
Angle of view	76°–29°	31.5°–11.9°	31.5°–8.1°
Aperture	f/3.5–f/5.6	f/2.8	f/4-5.6
Minimum aperture	f/22–f/38	f/22	f/22-32
Mount type	K _{AF} -mount	K _{AF2} -mount	K _{AF} -mount
Minimum focus distance	0.25m (0.82ft)	1.0m (3.3ft)	1.1m (3.6ft)
Maximum magnification	Approx. 0.34x	Approx. 0.17x	Approx. 0.24x
Filter size	52mm	67mm	52mm
Lens hood	PH-RBC 52mm	PH-RBK 67mm	PH-RBB 52mm (sold separately)
Max. diameter x length	68.5mm x 67.5mm (2.7in x 2.7in)	76.5mm x 136mm (3.0in x 5.4in)	66.5mm x 78.5mm (2.6in x 3.1in)
Weight	Approx. 235g/8.3oz (with hood approx. 260g/9.2oz)	Approx. 685g/24.2oz (with hood approx. 765g/27.0oz)	Approx. 235g/8.3oz (with hood approx. 265g/9.3oz)
Soft case	S80-120	S90-160	S80-120

Lens	DA 50-200mm f/4-5.6ED WR	DA 55-300mm f/4-5.8ED	DA* 60-250mm f/4ED [IF] SDM
Focal length	50-200mm (equivalent to approx. 76.5-307mm in 35mm format)	55-300mm (equivalent to approx. 84.5-460mm in 35mm format)	60-250mm (equivalent to approx. 92-383mm in 35mm format)
Elements in groups	11-10	12-8	15-13
Angle of view	31.5°–8.1°	29°–5.4°	26.5°–6.5°
Aperture	f/4–f/5.6	f/4–f/5.8	f/4
Minimum aperture	f/22–f/32	f/22–f/32	f/32
Mount type	KAF-mount	KAF-mount	KAF ₂ -mount
Minimum focus distance	1.1m (3.6ft)	1.4m (4.67ft)	1.1m (3.6ft)
Maximum magnification	Approx. 0.24x	Approx. 0.28x	Approx. 0.15x
Filter size	49mm	58mm	67mm
Lens hood	PH-RBD 49mm	PH-RBG 58mm	PH-RBK 67mm
Max. diameter x length	69mm x 79.5mm (2.7in x 3.1in)	71mm x 111.5mm (2.8in x 4.4in)	82mm x 167.5mm (3.2in x 6.6in)
Weight	Approx. 285g/10.1oz (with hood approx. 320g/ 11.3oz)	Approx. 440g/15.5oz (with hood approx. 470g/ 16.6oz)	Approx. 1,050g/37.0oz (with hood approx. 1,130g/39.9oz) (with hood + tripod attachment approx. 1,240g/43.7oz)
Soft case	Download for 2011 www.Somanuals.com	See 601 Manuals Search	See 200 Download.

For customers in USA**STATEMENT OF FCC COMPLIANCE**

This device complies with Part 15 of the FCC Rules. Operation is subject to the following two conditions : (1) This device may not cause harmful interference, and (2) this device must accept any interference received, including interference that may cause undesired operation.

Changes or modifications not approved by the party responsible for compliance could void the user's authority to operate the equipment.

This equipment has been tested and found to comply with the limits for a Class B digital device, pursuant to part 15 of the FCC Rules. These limits are designed to provide reasonable protection against harmful interference in a residential installation. This equipment generates, uses and can radiate radio frequency energy and, if not installed and used in accordance with the instructions, may cause harmful interference to radio communications. However, there is no guarantee that interference will not occur in a particular installation. If this equipment does cause harmful interference to radio or television reception, which can be determined by turning the equipment off and on, the user is encouraged to try to correct the interference by one or more of the following measures:

- Reorient or relocate the receiving antenna.
Increase the separation between the equipment and receiver.
Connect the equipment into an outlet on a circuit different from that to which the receiver is connected.
- *Consult the dealer or an experienced radio/TV technician for help.

For customers in Canada

This Class B digital apparatus complies with Canadian ICES-003.

Cet appareil numérique de la classe B est conforme à la norme NMB-003 du Canada.

Memo

Memo

Memo

HOYA CORPORATION

PENTAX Imaging Systems Division

2-36-9, Maeno-cho, Itabashi-ku, Tokyo 174-8639, JAPAN (<http://www.pentax.jp>)

PENTAX Europe GmbH Julius-Vosseler-Strasse 104, 22527 Hamburg, GERMANY

(European Headquarters) (HQ - <http://www.pentaxeurope.com>) (Germany - <http://www.pentax.de>)

PENTAX U.K. Limited PENTAX House, Heron Drive, Langley, Slough, Berks SL3 8PN, U.K. (<http://www.pentax.co.uk>)

PENTAX France S.A.S. 112 Quai de Bezons, B.P. 204, 95106 Argenteuil Cedex, FRANCE (<http://www.pentax.fr>)

PENTAX (Schweiz) AG Widenholzstrasse 1, 8304 Wallisellen, Postfach 367, 8305 Dietlikon, SWITZERLAND
(<http://www.pentax.ch>)

PENTAX Imaging Company

A Division of PENTAX of America, Inc.

(Headquarters)

600 12th Street, Suite 300 Golden, Colorado 80401, U.S.A.

(PENTAX Service Department)

12061 Tejon St. STE 600 Westminster, Colorado 80234, U.S.A.

(<http://www.pentaximaging.com>)

PENTAX Canada Inc. 1770 Argentia Road Mississauga, Ontario L5N 3S7, CANADA (<http://www.pentax.ca>)

**PENTAX Trading
(SHANGHAI) Limited** 23D, Jun Yao International Plaza, 789 Zhaojiabang Road, Xu Hui District, Shanghai, 200032
CHINA (<http://www.pentax.com.cn>)



The CE Mark is a Directive conformity mark of the European Union.

☆Specifications and external dimensions are subject to change without notice.

Copyright © HOYA CORPORATION 2009

57298EN Download from Wwww.Somanuals.com. All Manuals Search and Download. Vietnam

Free Manuals Download Website

<http://myh66.com>

<http://usermanuals.us>

<http://www.somanuals.com>

<http://www.4manuals.cc>

<http://www.manual-lib.com>

<http://www.404manual.com>

<http://www.luxmanual.com>

<http://aubethermostatmanual.com>

Golf course search by state

<http://golfingnear.com>

Email search by domain

<http://emailbydomain.com>

Auto manuals search

<http://auto.somanuals.com>

TV manuals search

<http://tv.somanuals.com>