

# PENTAX

## SMC PENTAX FA 645 INTERCHANGEABLE LENSES OPERATING MANUAL

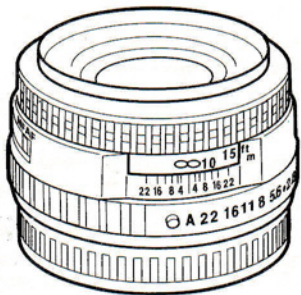

Thank you for selecting our SMC Pentax FA 645 lens. This book applies to all of the SMC Pentax FA 645 series lens, and should be used in combination with the usage instructions for your camera. In the instructions below, "SMC Pentax FA 645 lens" is only referred to as "FA lens". To ensure proper operation of your camera, be sure to read these instructions before using the equipment.

## FOR SAFE USE OF YOUR LENS

Although we have carefully designed this product for safe operation, please be sure to follow precautions given on this page.

### **WARNING**

This mark indicates precautions that, if not followed, could result in serious injury to the operator.

### **CAUTION**

This mark indicates precautions that, if not followed, could result in minor or medium injury to the operator or damage to the equipment.

 **WARNING**

Do not look directly at the sun through the lens. Doing so, could result in blindness.

 **CAUTION**

Do not leave the lens for long periods exposed to direct sunlight. The light reflected off the lens may focus on a nearby object, and cause a fire.

# CONTENTS

PRECAUTIONS AND LENS MAINTENANCE .....	3
ABOUT SMC PENTAX FA 645 LENSE .....	5
LENS ATTACHMENT AND REMOVAL .....	7
SWITCHING THE FOCUS MODE .....	8
USING THE APERTURE .....	10
USING THE INFRARED INDEX .....	12
LENS HOOD .....	13
FILTER .....	15
ZOOM LENS .....	17
TELEPHOTO LENSES .....	18
REAR CONVERTER .....	19
PENTAX FA 645 LENS SOFT CASE .....	20
SPECIFICATIONS .....	22
WARRANTY POLICY .....	24

## PRECAUTIONS AND LENS MAINTENANCE

- Avoid leaving the lens for extended periods in places where the humidity and temperature are very high, such as in a car.
- When storing the lens in a case, attach the front and rear lens cap that come supplied with the lens to protect it from dust and scratches.
- After removing the lens from the camera, be careful not let it roll over or fall. Be sure to place the lens with its front side down.
- Moisture can cause serious damage to optical glass elements. Storage in a damp place may cause mildew, so avoid storing the lens in a place where temperature and humidity are high. Keep your lens in as dry place possible.
- If you do not expect to use the lens for an extended period, store it in the case with a desiccant or it is recommended that the lens occasionally be taken out of the case placed in a cool, dry, well-ventilated place to avoid the possibility of damage due condensation build-up.

- Use a blower or lens brush to remove dust or fingerprints collected on the lens. If the lens becomes dirty, remove dirty particle with a blower brush, then wipe it off with a clean cotton cloth or tissue paper moistened with lens cleaning solution. Wipe in a spiral pattern from the center to the outside.
- Lenses are not waterproof, and therefore cannot be used where they will be directly exposed to rain.
- Sunlight can damage the internal parts of the camera. Do not allow the camera to remain on a tripod with the lens cap removed for a long period of time.

# ABOUT SMC PENTAX FA 645 LENS

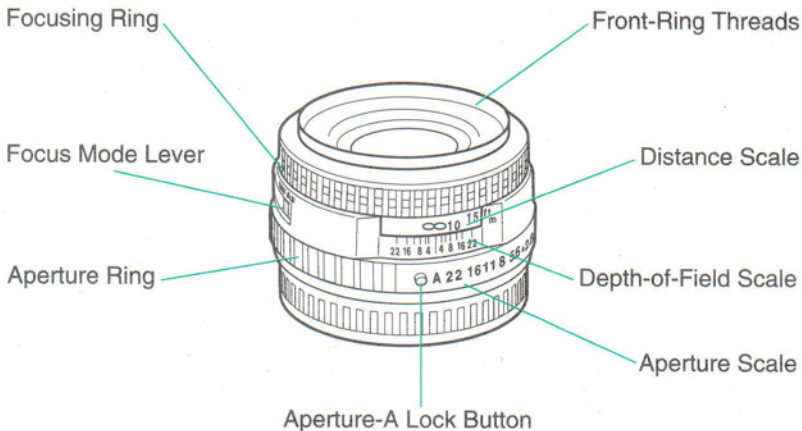

## 645 A mount

Lens  
information  
contacts

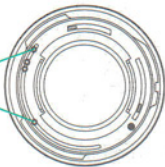

## 645 A<sub>F</sub> mount

Lens  
information  
contacts

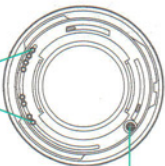

AF-coupler

## Mount Name

The FA lens mount combines the existing A lens with the AF coupler to implement an automatic focusing function.

## Lens Name and Mount Name

The name of the FA lens mount is the "645 AF mount," and the name of the A lens mount is the "645 A mount."

## Mount Interchangeability

Automatic focusing does not function with the FA lens mounted on a 645 camera, or the A lens on a 645N camera, although other functions are not affected.

## NOTE

The lens mount is equipped with a lens information contact and AF coupler. Allowing these to become damaged or dirty could result in malfunctioning or failure.



## LENS ATTACHMENT AND REMOVAL

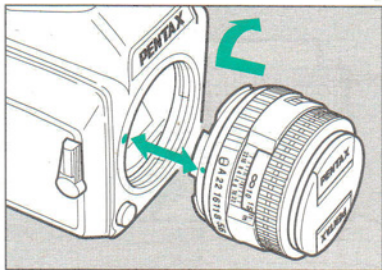

1. Align the red dot mounting indicators of the camera and lens, and fit and lock the lens on the camera by turning the lens clockwise until it clicks in place.

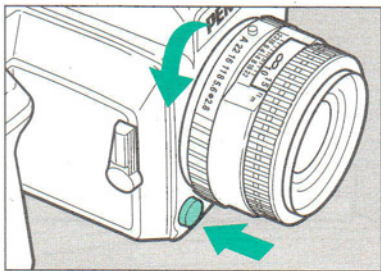

2. To remove the lens, turn the lens counterclockwise while pressing the lens unlock button.

## SWITCHING THE FOCUS MODE

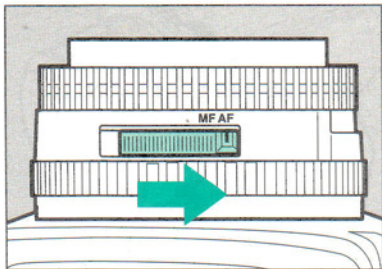

**For 75mm f/2.8 Lens:**

### **Turn on the Automatic Focus Mode.**

To use the camera in the automatic focus mode, move the focus mode lever to the "AF" position.

- The focusing ring turns automatically while focusing in the automatic mode. Do not obstruct the lens movement by holding with your hand or any other object.

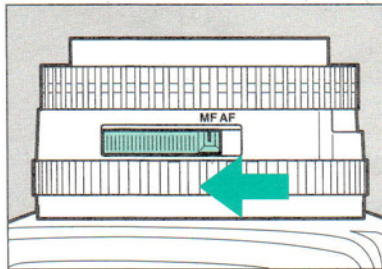

### **Turn on the Manual Focus Mode.**

To use the camera in the manual focus mode, move the focus mode lever to the "MF" position. Focusing is accomplished by turning the focusing ring until a clear image is seen in the camera's viewfinder.

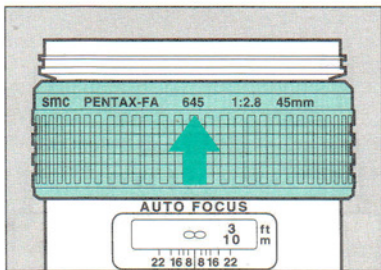

**For Lenses Other Than 75mm f/2.8:  
Turn on the Automatic Focus Mode.**

To use the camera in the automatic focus mode, push out the focusing ring until "AUTO FOCUS" is hidden.

- The focusing ring cannot be turned when in the automatic focus mode.

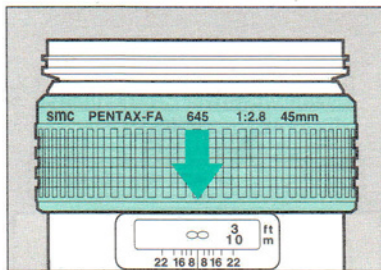

**Turn on the Manual Focus Mode.**

To use the camera in the manual focus mode, pull in the focusing ring until "AUTO FOCUS" is hidden. Manual focusing is accomplished by turning the focusing ring until a clear image is obtained in the camera's viewfinder.

## USING THE APERTURE

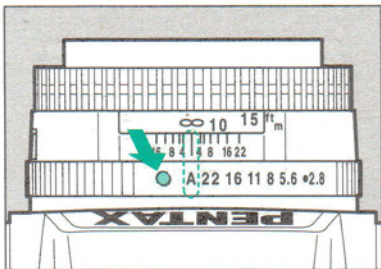

To set the aperture to "A" (Auto), match the green "A" on the aperture ring with the white line index while depressing the aperture A lock button. To off the A position: move the green "A" off the index line while pressing the aperture-A lock button.

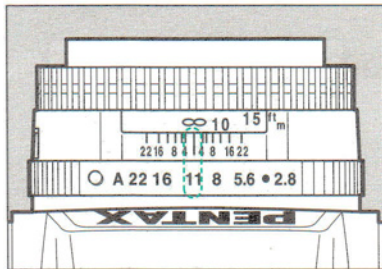

Set the lens aperture to any position other than the A position if using accessories such as a helicoid close-up ring which lacks the lens information contact between the camera and lens.

- If using a combination of 645N camera with FA or A lens, the approximate aperture value appears in the finder even if the aperture is not set to the A position.

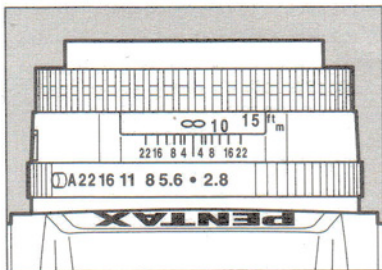

## Aperture Value and Click Stop

Some lens have a white dot next to the maximum f-number, which indicates the next aperture value. In the figure, for instance, the white dot next to  $f/2.8$  indicates "f/4."

The intermediate click portion without white dots between aperture values indicate intermediate aperture as shown in the table. There is not much clearance near the ends of the aperture scale so there is no intermediate click.

• 1.4	• 2	• 2.8	• 4	• 5.6	• 8	• 11	• 16	• 22	• 32	• 45
1.2	1.7	2.4	3.4	4.8	6.7	9.5	13.5	19	26	38

## USING THE INFRARED INDEX

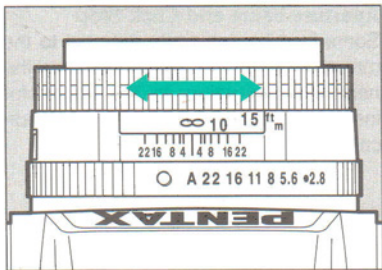

The focus position for taking infrared photographs using an R2 or O2 filter for infrared film differs from that of ordinary visible light photography and requires proper compensation.

1. Focus as normally as when using ordinary film.

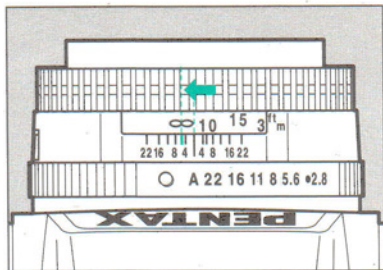

2. Set the lens to manual focus, and reset the focus-distance indicated from the center white line to the red infrared mark.

- For exposure, see the film instructions.

# LENS HOOD

Be sure to use a lens hood which properly fits the lens. The rubber type allows you to mount the lens cap inside the hood.

## Round Lens Hood

Hood Type	Mounting Method	Applicable Lens
RH-A 58mm	Screw-in	FA75mm f/2.8

RH = Rubber Hood

## Dedicated Lens Hoods (Accessory)

Hood Type	Mounting Method	Applicable Lens
PH-RBC67mm	Bayonet	FA45mm f/2.8
PH-RBD77mm	Bayonet	FA45-85mm f/4.5
PH-RBD77mm	Bayonet	FA*300mm f/4ED (IF)
	Bayonet	FA400mm f/5.6ED (IF)

PH = Plastic Hood

## Dedicated Lens Hoods

The dedicated hoods mentioned on page 13 are all bayonet type. To mount a dedicated hood, fit the hood on the front ring and turn it in the clockwise direction until it clicks in place. To remove, perform the procedure in reverse.

- When not in use, the hood can be mounted backwards. To fasten the hood, turn in the clockwise direction.

## NOTE

To attach the dedicated lens hood to the FA45mm f/2.8 or FA45-85mm f/4.5 lens, make sure to align the white dots on the hood and lens and turn the hood clockwise to lock it in place. The improper fitting will cause the vignetting in the picture corners.



## FILTER

Select a filter that matches the size of the lens, and mount by screwing it on the front ring.

### Precautions When Using Filters

When mounting a filter onto the lens, it becomes part of the optical system. The filter should be treated the same way as the lens against dirt, scratches, etc.

If using two or more filters, the focusing screen may become dark.

Polarizing filters: be sure to use only circular polarization filters.

SIZE	APPLICABLE LENSES
58mm	FA75mm f/2.8
67mm	FA45mm f/2.8
77mm	FA* 300mm f/4 ED(IF) FA400mm f/5.6 ED(IF) FA45 - 85mm f/4.5

## Circular Polarizing Filter and Vignetting

The circular type filter consists of two glass elements, and is thicker than an ordinary filter. For this reason, using the circular type on the lenses as shown on the table to the right may cause vignetting in the picture corners.

SIZE	LENSES
67mm	FA45mm f/2.8
77mm	FA45-85mm f/4.5

# ZOOM LENS

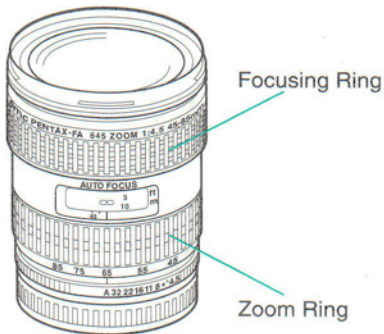

- Turning the zoom ring counterclockwise widens the picture area (wide-angle), and turning it clockwise brings far-away objects up closer (telephoto).
- The focus position may change slightly when the focal distance is changed using a zoom lens. To assure focus accuracy, re-focus the lens after setting the desired focal length.

# TELEPHOTO LENSES

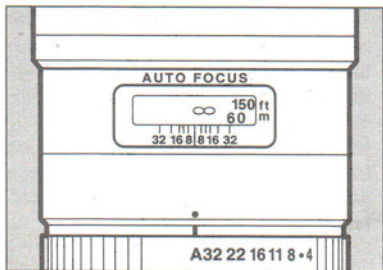

## Precaution Concerning the ∞ Scale

The FA \*300mm f/4ED (IF) and FA400 mm f/5.6ED (IF) lens are designed so that the focusing ring stops after the ∞ position is slightly exceeded. This is because changes in temperature can cause the focus position to change, and may focus past the ∞ position in some cases. Before photographing at ∞, check the focus in the viewfinder.

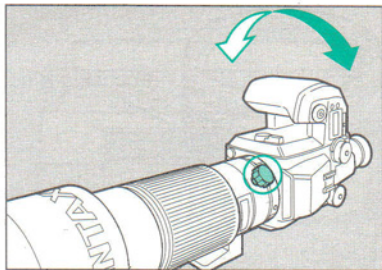

## Shifting the camera position for FA300mm and FA400mm lenses

To position the camera vertically or horizontally, loosen the camera position shift lock screw, turn the camera 90° to the right or left as desired, and tighten the lock screw firmly.

- The focusing ring cannot be turned once you set the lens to the automatic focusing mode.

## REAR CONVERTER

For mounting and removing the rear converter, please refer to the instructions for the rear converter.

- Automatic focusing does not function when using a rear converter.

### Applicable Lens

#### Rear Converter A646 1.4 x

- FA\* 300mmf/4 ED(IF)
- FA400mm f/5.6ED(IF)

#### Rear Converter A645 2 x

FA45mm f/2.8

FA75mm f/2.8

FA\* 300mm f/4 ED(IF)

FA400mm f/5.6ED(IF)

FA45 - 85mm f/4.5

## PENTAX FA 645 LENS SOFT CASE



The case code number for lens soft cases are as given in the following table. Use the case that matches your lens.

<b>Code number on the case</b>	<b>Lenses</b>
S90-100	FA45mm f/2.8
S80-80	FA75mm f/2.8
S120-230	FA*300mm f/4ED(IF)
S120-280	FA400mm f/5.6ED(IF)
S130-160	FA45 - 85mm f/4.5

S120-230 and S120 - 280 are equipped with a pocket inside for small accessories.

# SPECIFICATIONS

Type	Lens	Lens Construction (Groups - Elements)	Angle of View (Degrees)
Wide Angle	SMC Pentax-FA 645 45mm f/2.8	8 - 9	76
Standard	SMC Pentax-FA 645 75mm f/2.8	5 - 6	50
Telephoto	SMC Pentax-FA* 645 300mm f/4 ED (IF)	8 - 8	13.5
	SMC Pentax-FA 645 400mm f/5.6 ED (IF)	6 - 7	10
Zoom	SMC Pentax-FA 645 45 - 85mm f/4.5	9 - 11	76 - 44.5

- ED=Achromatic lens including elements of the Extra-low Dispersion glass
- IF=Lens featuring the inner focusing mechanism



Diaphragm	Minimum Focusing Distance		Minimum Aperture	Max. Dia. Length ( $\phi$ mm x mm)	Weight		Filter Size [mm]
	[m]	[ft]			[gr.]	[oz.]	
F.A.	0.45	1.5	22	76.5 x 66.5	475	16.8	67
F.A.	0.60	2	22	74.5 x 37.5	215	7.6	58
F.A.	3.0	9.8	32	83 x 207.5	1480	52.2	77
F.A.	3.0	9.8	45	83 x 252	1250	44.1	77
F.A.	0.5	1.6	32	85 x 99.5	870	30.7	77

**SPECIFICATIONS ARE SUBJECT TO CHANGE AT ANY TIME WITHOUT NOTIFICATION OR ANY OBLIGATION ON THE PART OF THE MANUFACTURER.**

# WARRANTY POLICY

All Pentax cameras purchased through authorized bona fide photographic distribution channels are guaranteed against defects of material or workmanship for a period of twelve months from date of purchase. Service will be rendered, and defective parts will be replaced without cost to you within that period, provided the equipment does not show evidence of impact, sand or liquid damage, mishandling, tampering, battery or chemical corrosion, operation contrary to operating instructions, or modification by an unauthorized repair shop. The manufacturer or its authorized representatives shall not be liable for any repair or alterations except those made with its written consent and shall not be liable for damages from delay or loss of use or from other indirect or consequential damages of any kind, whether caused by defective material or workmanship or otherwise; and it is expressly agreed that the liability of the manufacturer or its represen-

tatives under all guarantees or warranties, whether expressed or implied, is strictly limited to the replacement of parts as herein before provided. No refunds will be made on repairs by non-authorized Pentax service facilities.

## **Procedure During 12-month Warranty Period**

Any Pentax which proves defective during the 12-month warranty period should be returned to the dealer from whom you purchased the equipment or to the manufacturer. If there is no representatives of the manufacturer in your country, send the equipment to the manufacturer, with postage prepaid. In this case, it will take a considerable length of time before the equipment can be returned to you owing to the complicated customs procedures required. If the equipment is covered by warranty, repairs will be made and parts replaced free of charge, and the equipment

will be returned to you upon completion of servicing. If the equipment is not covered by warranty, regular charges of the manufacturer or of its representatives will apply. Shipping charges are to be borne by the owner. If your Pentax was purchased outside of the country where you wish to have it serviced during the warranty period, regular handling and servicing fees may be charged by the manufacturer's representatives in that country. Notwithstanding this, your Pentax returned to the manufacturer will be serviced free of charge according to this procedure and warranty policy.

In any case, however, shipping charges and customs clearance fees to be borne by the sender. To prove the date of your purchase when required, please keep the receipt or bills covering the purchase of your equipment for at least a year. Before sending your equipment for servicing, please make sure that you are sending it to the manufacturer's authorized representa-

tives or their approved repair shops, unless you are sending it directly to the manufacturer. Always obtain a quotation for the service charge, and only after you accept the quoted service charge, instruct the service station to proceed with the servicing.

**The local warranty policies available from Pentax distributors in some countries can supersede this warranty policy. Therefore, we recommend that you review the warranty card supplied with your product at the time of purchase, or contact the PENTAX distributor in your country for more information and to receive a copy of the warranty policy.**



Asahi Optical Co., Ltd. 11-1, Nagata-cho 1-chome, Chiyoda-ku, Tokyo 100, JAPAN (Internet: //www.pentax.co.jp/)

Pentax Europe n.v. Weveldiaan 3-5, 1930 Zaventem, BELGIUM (Internet: //www.pentaxeuropa.com/)

Pentax GmbH, Julius-Vosseler-Strasse, 104, D-22527 Hamburg, GERMANY (Internet: //www.pentax.de/)

Pentax U.K. Limited Pentax House, Heron Drive, Langley, Slough Berks SL3 8PN, U.K.

Pentax France S.A. 12/14, rue Jean Poulmarch, 95100 Argenteuil Cedex, FRANCE

Pentax Benelux B.V. (for Netherlands) Spinveld 25, 4815 HR Breda, NETHERLANDS

(for Belgium & Luxemburg) Weveldiaan 3-5, 1930 Zaventem, BELGIUM

Pentax (Schweiz) AG Industriestrasse 2, 8305 Dieltikon, SWITZERLAND

Pentax Scandinavia AB P.O. Box 650, 75127 Uppsala, SWEDEN

Pentax Corporation 35 Inverness Drive East, Englewood, Colorado 80112, U.S.A. (Internet: //www.pentax.com/)

Pentax Canada Inc. 3131 Universal Drive, Mississauga, Ontario L4X 2E5, CANADA



The CE marking assures that  
this product complies with  
the requirements of the EC  
directive for safety.

Copyright © Asahi Optical Co., Ltd. 1997

## Free Manuals Download Website

<http://myh66.com>

<http://usermanuals.us>

<http://www.somanuals.com>

<http://www.4manuals.cc>

<http://www.manual-lib.com>

<http://www.404manual.com>

<http://www.luxmanual.com>

<http://aubethermostatmanual.com>

Golf course search by state

<http://golfingnear.com>

Email search by domain

<http://emailbydomain.com>

Auto manuals search

<http://auto.somanuals.com>

TV manuals search

<http://tv.somanuals.com>