

PENTAX™

smc PENTAX-FA INTERCHANGEABLE LENS OPERATING MANUAL

Thank you for purchasing the smc PENTAX lens.

This operating manual applies to all of the smc PENTAX FA, FA J and F lenses.

- ※ In this manual, smc PENTAX FA lens is referred to as FA lens.
- ※ Please also read your camera's operating manual.
- ※ Illustrations shown herein may differ from the actual appearance.



CONTENTS

◦ FOR SAFE USE OF YOUR LENS	1	• Aperture	
◦ PRECAUTION AND LENS MAINTENANCE	2	• Infrared index of the zoom lens	
◦ smc PENTAX F, FA and FA J LENSES ...	3	◦ MACRO LENS	22
• Mount compatibility		• Focus range limiter	
◦ MOUNTING AND REMOVING OF LENS	5	• Clamp screw	
◦ FINGER POINT	6	• Tripod mount	
◦ APERTURE CONTROL	6	• Magnification	
◦ FOCUSING	7	◦ WIDE-ANGLE LENS (FA★24mm f/2 AL (IF))	27
◦ HOW TO USE INFRARED INDEX	9	◦ TELEPHOTO LENS FA★85mm f/1.4 (IF) FA★200mm f/2.8ED (IF), FA★300mm f/4.5ED (IF)	28
◦ LENS HOOD	10	• Note on ∞ (infinity) mark	
• Square lens hood		◦ PRECAUTIONS WHEN THE FLASH IS USED	30
• Round-type lens hood		◦ SOFT CASE FOR LENS	31
• Built-in lens hood		◦ SPECIFICATIONS	32
◦ FILTER	14	◦ COMPATIBILITY OF LENSES WITH THE BUILT-IN FLASH	38
◦ ZOOM LENS	16		
◦ POWER ZOOM LENS	17		
• Power zoom ring			

Although we have carefully designed these lenses for safe operation, please pay special attention to items marked with the following symbols when using this product.



WARNING

This mark indicates precautions that if not followed, could result in serious injury to the user.



CAUTION

This mark indicates precautions that if not followed, could result in minor or medium injury to the user or damage to the equipment.



WARNING

- Never look at the sun through the lens or camera. Serious damage to the retina, or total loss of eyesight may occur.
- Wrapping the strap around your neck is dangerous. Make sure that small children do not get the strap caught their neck. (A strap is supply only with some large types of lenses)



CAUTION

- Do not leave the lens in direct sunlight without lens caps. Sunrays passing through the lens will be intensified, and should they focus on flammable materials, fire may occur.

PRECAUTION AND LENS MAINTENANCE

1. Storage and mildew prevention

- Take the lens out of the protective case or camera bag, and store it in a dry, well-ventilated place.
- Avoid storing the lens in a poorly ventilated location such as a closet, wardrobe, drawer, vehicle, or where insect repellent or medicine is kept.
- Avoid storing the lens in areas of high temperature and humidity, where there is a risk of mildew growth.

Store the lens with a desiccant in a dry cabinet, airtight container, or plastic bag. (Leaving a saturated desiccant in the storage container can cause damage to the lens. Be sure to read the instructions that came with the desiccant before use.)

2. The lens is not waterproof. When using the lens in a rain or mist, be careful not to allow it to get wet.
3. Never use any organic solvent such as thinner, alcohol, or benzene, etc. to remove dust on the lens.
4. The lens is a precise optical instrument. Be careful not to let it fall, or subject it to strong shocks or pressure. Use a cushion or similar pad to protect the lens from the vibrations of motorcycles or other vehicles, boats, etc.
5. Avoid subjecting the lens to rapid changes in temperature, otherwise condensation can occur on both the inside and the outside of the lens. Put the lens in a plastic bag or camera bag, and take it out after the lens has reached ambient temperature.
6. When the lens is not attached to the camera body, attach both the supplied lens cap and lens mount cap to protect it from dust.
7. Do not leave the camera with the lens cap off attached to a tripod or other rigid camera support. The inner parts of the camera can be damaged by direct sunlight.
8. Have the lens inspected by a dealer every one or two years to maintain its high performance.

smc PENTAX F, FA and FA J LENSES

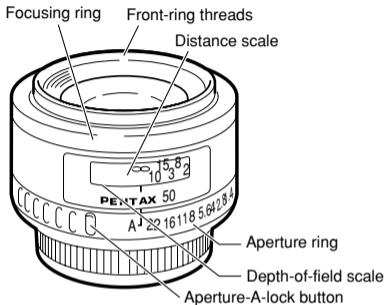

K_{AF}-mount

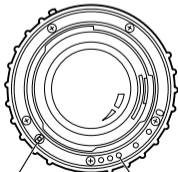

AF coupler
Lens-information

The Pentax FA lenses are primarily designed to work with the Pentax autofocus SLR (K_{AF}- or K_{AF2}-mount camera), making autofocus shooting possible.

When Pentax FA Zoom lenses with power zoom function are used on the Pentax K_{AF2}-mount camera, the camera features a Power Zoom system.

- An FA zoom lens without the power zoom contacts are shown in the illustration does not have the power zoom function.
- Do not damage or dirty the power contacts.

K_{AF2}-mount

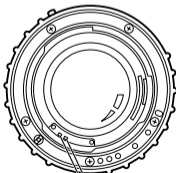

Power zoom contacts

- When using FA lens with the K-mount Pentax camera having no lens information contacts, be sure to set the lens aperture ring to any f-stop other than A. If set to the "A" position, the lens will automatically be set to the minimum aperture, causing improper exposure.

CAUTION :

- Be careful not to damage or dirty the lens information contacts and AF coupler on the mount surfaces of the camera and lens. Otherwise, failure or malfunction may result. If this occurs, wipe them gently with a clean, dry cloth.
- FA J18-35mm f/4-5.6AL, FA J28-80mm f/3.5-5.6AL and FA J75-300 mm f/4.5-5.8AL lenses have no aperture ring to set a f-stop manually. Aperture settings are controlled automatically as if set to the auto "A" position, so accessories without an auto "A" setting cannot be used with these lenses.

Camera/Lens Mount Compatibility

Pentax camera/lens mount compatibility chart is shown below.

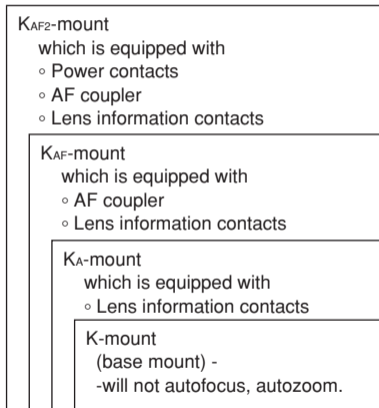

MOUNTING AND REMOVING OF LENS

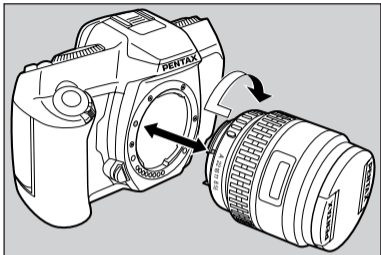

1. To mount the lens on the camera body

Align the red dots on the lens and camera body, and then turn the lens clockwise until it clicks into place.

※After mounting the lens, try to turn the lens counterclockwise to make sure it is locked in place.

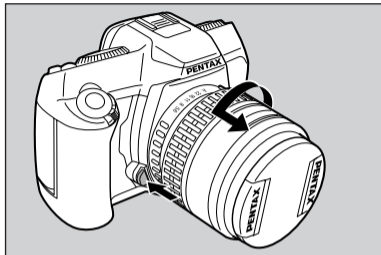

2. To remove the lens

Hold down the lens unlock button on the camera body and turn the lens counterclockwise.

FINGER POINT

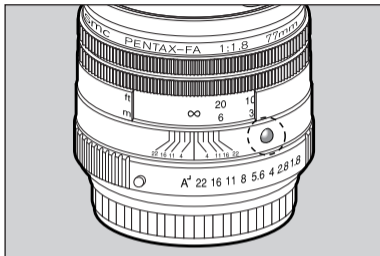

The lens can be mounted on the camera by aligning the finger point with the lens unlock button.

- Following Limited lenses have finger point.

FA31mm f/1.8AL Limited.

FA43mm f/1.9 Limited.

FA77mm f/1.8 Limited.

APERTURE CONTROL

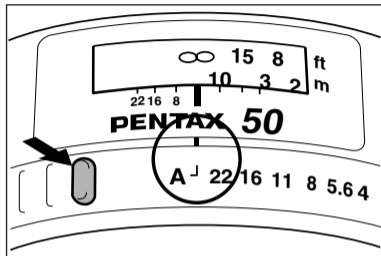

Setting the aperture to "A"(Auto)

Turn the aperture ring to align the aperture-A index with the line while depressing the Aperture-A-lock button. The aperture ring can be released from "A" in the same manner to set your desired f-stop manually.

- FA28-105mm f/4-5.6(IF) and FA28-200 mm f/3.8-5.6AL lenses can set to "A" position without depressing the Aperture-A-lock button.
- When using the camera body with no lens information contact, set the aperture ring to desired f-stop other than "A" position.

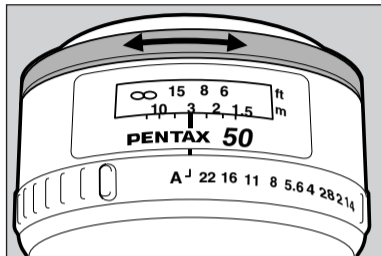
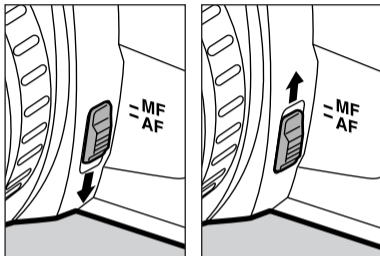

To set the focus mode

Slide the focus mode switch on the camera body to change the focus mode to AF (Autofocus) or MF (Manual focus).

- During autofocus, do not touch the focusing ring of your lens or you will interfere with proper lens movement.

In manual focus mode

You can adjust focus on the subjects by turning the focusing ring manually and confirming the focus indicator in the viewfinder.

- FA 28-90mm f/3.5-5.6, FA J 28-80mm f/3.5-5.6AL and FA J 75-300mm f/4.5-5.8AL lenses have no distance scale, adjust focus with aid of the matte field for non-auto focus camera or using focus indicator in the viewfinder for auto focus camera.

F-STOPS OR F-NUMBERS AND CLICK STOPS

There is a white dot next to the maximum f-number engraved on the lens's aperture ring on many Pentax lenses. This white dot indicates an aperture which is darker by one stop (larger number). The illustration below shows the white dot next to f/4.5 is f/5.6.

The click stops between two engraved f/stops are equivalent to intermediate f-stops. Some lenses do not have an intermediate click f-stop on the aperture ring due to limited space between the f-numbers engraved on the aperture ring.

• 1.4	• 2	• 2.8	• 4	• 5.6	• 8	• 11	• 16	• 22	• 32	• 45
1.2	1.7	2.4	3.4	4.8	6.7	9.5	13.5	19	26	38

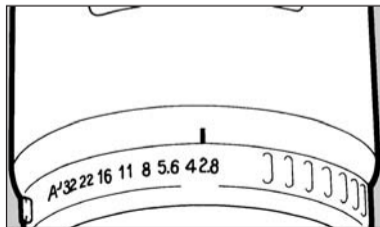
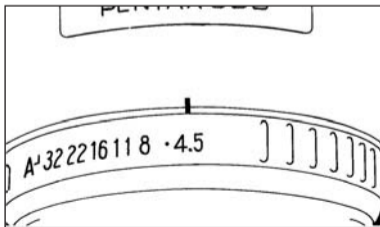

HOW TO USE THE INFRARED INDEX

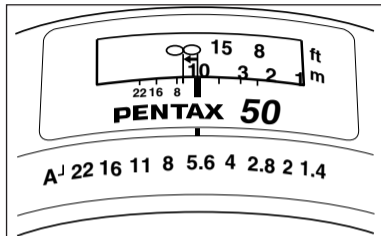
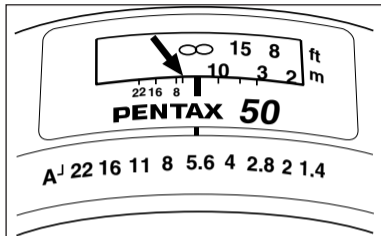

When taking infrared pictures with infrared film and either a "R2" or "02" filter, it is necessary to adjust the focus because the point of focus is not the same with infrared light as it is with visible light. As shown above, memorize the focusing point on the lens distance scale when viewed through the viewfinder and turn the focusing ring until the point you memorized aligns with the infrared index.

- Turn the focusing ring in the MANUAL focus mode only.
- For the exposure control required in this special photography, see the information supplied with the infrared film.
- Caution :
Infrared film can not be used for MZ-S, MZ-60 and *ist cameras since infrared ray is used for detecting device of film transport. It will expose infrared film in the camera.

LENS HOOD

Make sure to use a proper size lens hood specially designed for your lens.

Square Hoods (Clip-on type)	
PH-SA49	FA50mm f/1.4 & f/1.7
PH-SB49	FA28mm f/2.8AL, FA Sofy28mm f/2.8
Round Hoods (screw-in-type)	
PH-RA49	FA50mm f/1.4 & f/1.7
RH-RA49	F & FA Zoom 35-80mm f/4-5.6
RH-RB49	FA Zoom 70-200mm f/4-5.6 F & FA Zoom 80-200mm f/4.7-5.6 FA Macro 100mm f/3.5
RH-RC49	FA50mm f/1.4 & f/1.7
MH-RA49	FA43mm f/1.9 Limited
RH-RA52	FA Macro 50mm f/2.8
RH-RB52	FA Zoom 28-70mm f/4AL
MH-RB52	FA Soft 85mm f/2.8
RH-A58	FA Zoom 80-320mm f/4.5-5.6 F Zoom 100-300mm f/4.5-5.6 FA Zoom 100-300mm f/4.7-5.8
RH-RC58	FA Zoom 28-80mm f/3.5-5.6 FA Zoom 28-90mm f/3.5-5.6 FA Zoom 28-105mm f/4-5.6
MH-RB67	FA 20mm f/2.8
MH-RA112	FA* 300mm f/2.8ED (IF)

Notes :

- Do not use the built-in flash with lens hood because it blocks the flash light, except the FA43mmf/1.9 Limited lens.

Bayonet-type	
PH-RBA49	FA 35mm f/2AL
PH-RBA58	FA Zoom 20-35mm f/4AL
PH-RBA62	FA Zoom 28-105mm f/4-5.6 (IF)
PH-RBC58	FA Zoom 28-105mm f/3.2-4.5AL (IF)
PH-RBE58	FA J Zoom 28-80mm f/3.5-5.6AL
PH-RBF58	FA J Zoom 75-300mm f/4.5-5.8AL
PH-RBB67	FA* 24mm f/2AL (IF)
PH-RBE67	FA Zoom 24-90mm f/3.5-4.5AL (IF)
PH-RBG67	FA* Macro 200mm f/4ED (IF)
PH-RBL67	FA J Zoom 18-35mm f/4-5.6AL
MH-RBD67	FA* 85mm f/1.4 (IF)
MH-RBB77	FA* 200mm f/2.8ED (IF) FA* 400mm f/5.6ED (IF)
MH-RBC67	FA* 300mm f/4.5ED (IF)
PH-RBA72	FA Zoom 28-200mm f/3.8-5.6AL (IF)
PH-RBC77	FA* Zoom28-70mm f/2.8AL FA* Zoom 80-200mm f/2.8ED (IF)

PH = Plastic, RH = Rubber, MH = Metal

- When using the FA28-70mmf/4AL lens with lens hood and filter, it may cause vignetting at edges of picture at focal length of 35mm and shorter. (Except *ist D)
- The external flash can be used with lens hood attached to lens. FA* 28-70mm f/2.8AL lens with the external flash, refer to

How to Use the Square Hood

Attach the square hood to the front of the lens while pressing the knurled tabs on both sides of the hood.

- Make sure to keep the top and bottom of the hood parallel with the top and bottom covers of the camera.

The improper fitting will cause the vignetting in the picture corners.

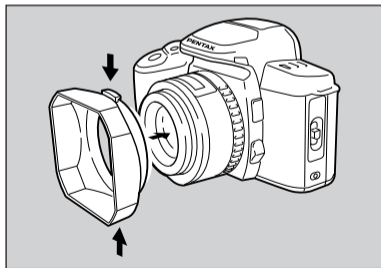

How to Use the Round Hood

The round hood screws into the front of the lens.

- The round type rubber hood can be folded when not in use.

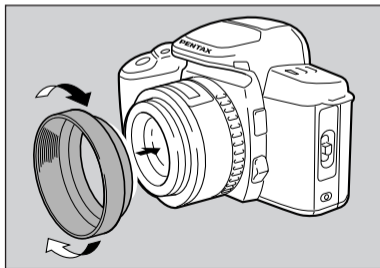

How to Use the Built-in Hood

To use a lens with a built-in hood, first extend the hood to the fullest position. The 600mm f/4 lens and 250-600mm f/5.6 zoom lenses come in screw-fixed-type. Extend these hoods while rotating them for use. See the lens instruction manual for details.

Lenses with Built-in Hoods

FA 31mm f/1.8 AL Limited

FA 77mm f/1.8 Limited

FA 135mm f/2.8 (IF)

FA 600mm f/4 ED (IF)

FA Zoom 250-600mm f/5.6 ED (IF)

* The built-in flash of the camera can be used when the built-in hood is utilized on the FA 77mmf/1.8 and FA 135 mm f/2.8 lens.

- For more details of Bayonet hoods, refer to page 28.

LENS HOOD for FA* 24mm f/2

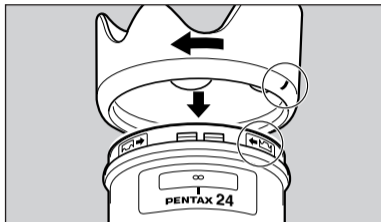

How to attach

To attach the hood to the lens, align (|) on the hood and (◀) on the lens front, then turn the hood clockwise to lock it in place. To remove it, reverse the above procedure.

- When the hood is not in use, align (|) on the hood and (▶) on the lens front, then turn the hood counterclockwise to lock it in place.
- Always attach the lens hood to avoid stray light.

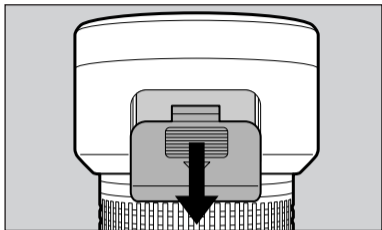

How to Use the Lens Hood with polarizing filter window

1. Remove the PL filter window cap by sliding it in the direction shown.
- The hood is designed for use with a polarizing filter or circular polarizing filter, and includes a "PL filter window" for adjusting the polarizing effect.
 - When attaching the hood, align the white dots on the lens and hood so that the PL filter window positions on the bottom.

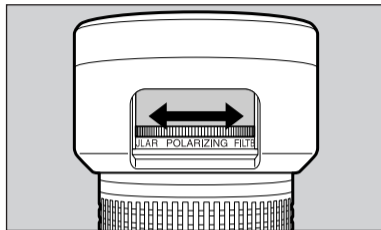

2. Turn the outer rim of the polarizing filter or circular polarizing filter from the PL filter window as shown.
3. Attach the PL filter window cap.

Notes :

- Be sure that the PL filter window cap is in place if no polarizing filter or circular polarizing filter is used.
- If strong light is entering the PL filter window, either attach the PL filter window cap or reverse the position of the PL filter window (to top or bottom of lens). Strong light entering the PL filter window will defeat the effect of the lens hood and prevent the taking of clear, sharp images.
- When the Pentax circular polarizing filter 58mm, which has the knurl ring on the back is used with the FA Zoom24-90mm f/3.5-4.5AL (IF) or FA Zoom 28-105mm f/3.2-4.5AL (IF) lens, the special lens hood cannot be attached. When a non-Pentax circular polarizing filter is attached, it also may not be attached.

Screw-in Type Filters

This type of filter screws into the front of the lens. Make sure to use the proper size Pentax filter specially designed for your lens.

Precaution on filters

Attaching the filter to your lens becomes a part of the optic.

Avoid using no more than one filter exception of with a polarizing filter, as deterioration in image quality may results.

- Attach the 43mm filters supplied with following lenses to the filter holder in the rear of lens.
 - FA★ 300mm f/2.8ED (IF)
 - FA★ 600mm f/4ED (IF)
 - FA★ 250-600mm f/5.6ED (IF)
- A filter cannot be attached to the F Fish-Eye Zoom 17-28mm lens.

FILTERS

Size	Lens
49mm	FA 28mm f/2AL, FA Soft 28mm f/2.8, FA 35mm f/2AL, FA 43mm f/1.9 Limited, FA 50mm f/1.4 & f/1.7, FA 77mm f/1.8, FA Zoom 70-200mm f/4-5.6, F & FA Zoom 35-80mm f/4-5.6, F & FA Zoom 80-200mm f/4.7-5.6, FA Macro 100mm f/3.5
52mm	FA 135mm f/2.8 (IF), FA Soft 85mm f/2.8, FA Macro 50mm f/2.8, FA Zoom 28-70mm f/4 AL
58mm	FA 31mm f/1.8AL Limited, FA Zoom 20-35mm f/4AL, FA Zoom 28-80mm f/3.5-5.6, FA J Zoom 28-80mm f/3.5-5.6AL, FA Zoom 28-90mm f/3.5-5.6, FA Zoom 28-105mm f/3.2-4.5AL (IF), FA Zoom 28-105mm f/4-5.6, FA J Zoom 75-300mm f/4.5-5.8AL, FA Zoom 80-320mm f/4.5-5.6, F Zoom 100-300mm f/4.5-5.6, FA Zoom 100-300mm f/4.7-5.8, FA Macro 100mm f/2.8
62mm	FA 28-105mm f/4-5.6 (IF)
67mm	FA 20mm f/2.8, FA* 24mm f/2AL (IF), FA* 85mm f/1.4 (IF), FA* Macro 200mm f/4ED (IF), FA* 300mm f/4.5ED (IF), FA J Zoom 18-35mm f/4-5.6AL, FA Zoom 24-90mm f/3.5-4.5AL (IF), FA* Zoom 28-70mm f/2.8AL
72mm	FA 28-200mm f/3.8-5.6
77mm	FA* 200mm f/2.8ED (IF), FA* 400mm f/5.6ED (IF), FA* Zoom 80-200mm f/2.8ED (IF)

Precautions for using a polarizing filter

The circular polarizing filter is thicker than an ordinary one.

For this reason, using the circular polarizing filter with lenses as shown on the chart on the right may cause vignetting at the edges of picture.

No vignetting occur when the circular polarizing filter on the lens is used with the *ist D camera.

Size	Lens
52mm	FA Zoom 28-70mm f/4AL
58mm	FA Zoom 20-35mm f/4AL FA Zoom 28-80mm f/3.5-5.6 FA Zoom 28-90mm f/3.5-5.6 FA Zoom 28-105mm f/4-5.6
67mm	FA Zoom 24-90mm f/3.5-4.5AL (IF) FA* Zoom 28-70mm f/2.8AL FA 20mm f/2.8

- Use a circular polarizing filter with Auto-focus camera for proper exposure and auto

ZOOM LENS

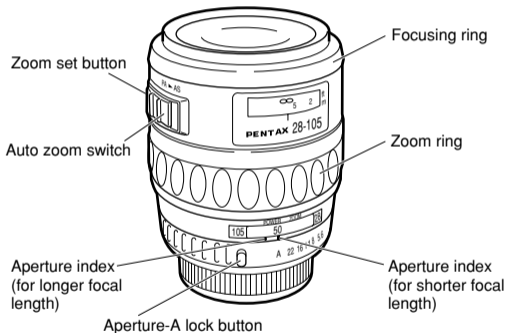

* An FA Zoom lens without the power supply contacts on its mount does not have the zoom set button and auto zoom switch.

Pentax FA and F zoom lens incorporate two-ring system: it has separate focusing and zooming ring. You can set your desired focal length by turning the zoom ring.

It may shift the focusing point slightly by changing the focal length. First, adjust zooming and then adjust focus using Autofocus or focus indicator in the viewfinder.

The following zoom lenses also refer to its operating manual.

FA★ 28-70mmf/2.8AL

FA★ 80-200mmf/2.8ED

FA★ 250-600mmf/5.6ED

The following lenses have power supply contacts to capable power zoom function with the K_{AF2}-mount cameras. Refer to the camera's operating manual for more details.

FA★ 28-70mmf/2.8AL

FA 28-105mmf/4-5.6

FA 70-200mmf/4-5.6

FA★ 80-200mmf/2.8ED(IF)

FA★ 250-600mmf/5.6ED(IF)

Auto zoom functions

The FA Zoom lens with power contacts combined with K_{AF2}-mount cameras can use following functions. Please refer to your camera's operating manual for more details.

1. Zoom clip mode to pre-set or re-call the focal length
2. Image size tracking mode to maintain the image size (magnification value) regardless of the distance to the subject.
3. Zoom effect mode to zoom automatically during an exposure.

Auto zoom switch and Zoom set button

1. P (Power zoom), PZ in some lenses
Set to this position in power zooming
2. A (Auto zoom), AZ in some lenses
Set to this position for Auto zoom
3. AS (Auto zoom set), MODE in some lenses
Set this position to select the type of Auto zoom function.

Automatic lens retraction

When the power zoom lens is used with K_{AF2}-mount cameras, the following functions work when the main switch is turned off.

1. The zoom ring automatically retracts to its shortest length.
2. The focusing ring is set to infinity(∞).
With the combination of MZ-S camera, the zoom ring retracts to shortest length only.

Note on Tulip mark ()

The zoom lens provide with the tulip mark () on the focusing ring that enable to take a picture at closest distance as a fixed focal length lens, even set at wide-angle position. However, at the edges of picture may be darkened due to reducing brightness of image field.

When combined with non-K_{AF2}-mount cameras, FA Zoom lens with power supply contacts does not work following functions.

- As the Power Zoom function does not work, set the manual zoom mode. Pull the zoom ring towards the camera side until the words "POWER ZOOM" disappears to set the manual zoom mode.
- The Auto Zoom switch and Zoom Set button do not work.

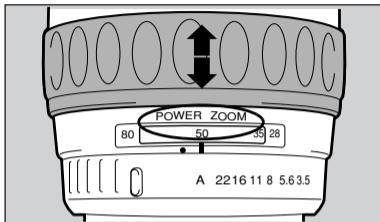

Using the power zoom

Push the zoom ring forward until the word "POWER ZOOM" appears on the ring, and move the zoom ring to right or left to change the focal length.

Using the manual zoom

Pull the zoom ring back to use as manual zoom ring, the word "POWER ZOOM" disappears.

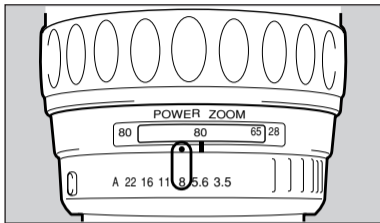

Manual aperture

To set the aperture of the zoom lens manually, align the aperture-A index with the white-bar index. The dot on the left-hand side of the white-bar index serves as an index to align an f-stop other than "A" when shooting at a longer focal length.

For example, when using the FA Zoom 28-80 mm lens and wishing to set the aperture to f/8 with the focal length at 80 mm, align "8" on the aperture ring with the dot on the left-hand side.

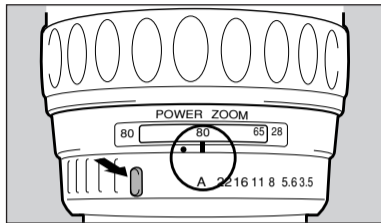

"A" (Auto) position

To set the aperture to "A" (Auto), align the aperture-A index with the white-bar index, regardless of focal length selected.

Infrared Index of the Zoom Lens

When taking infrared photographs with the zoom lens, compensation in focus is necessary depending upon the focal length. The distance scale of the zoom lens has infrared indexes for each focal length.

Compensate for the focus according to the focal length in use (see page 9.).

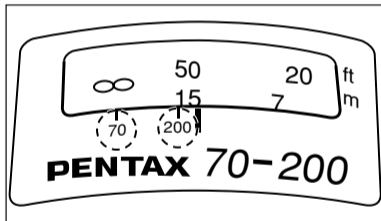

With lenses having indexes only for the longest and shortest focal length, such as FA Zoom 70-200mm, obtain the compensation value for intermediate focal length by using the scale as a guide.

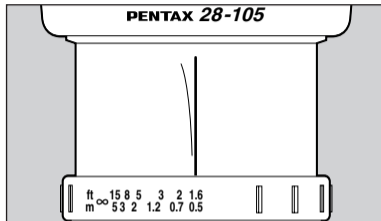

The red line on the lens barrel of the FA28-105mm f/4-5.6 (IF) is the infrared index line. Compensate for focus according to the focal length in use. See more details on page 9.

- The following lenses have no infrared index line.

FA Zoom 28-90mm f/3.5-5.6

FA Zoom 28-200mm f/3.8-5.6

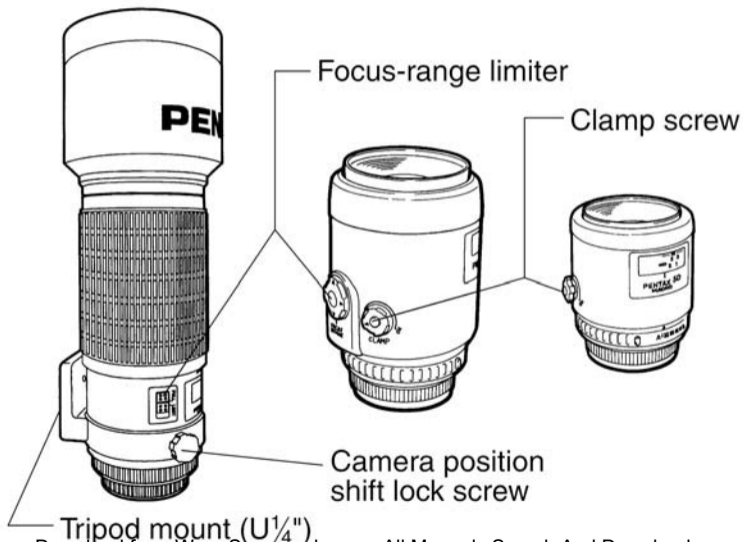

FA Macro 50mm f/2.8, FA Macro 100mm f/2.8 and FA★ Macro 200mm f/4ED (IF) lenses adjust focus from infinity to life-size. FA Macro 100mm f/3.5 lens adjust focus from infinity to 1/2x.

Focus-range limiter

FA Macro100mm f/2.8 and FA★ Macro 200mm f/4ED (IF) lenses equipped with the focus-range limiter that control the focusing ranges to adjust Autofocus quickly.

To set the focus-range limiter

Turn the focus limiter to "LIMIT" with the focusing ring at infinity, the focusing range is set to long-distance range, and do the same with the focusing ring at minimum distance for short-distance range. Refer to chart for focusing range on page22.

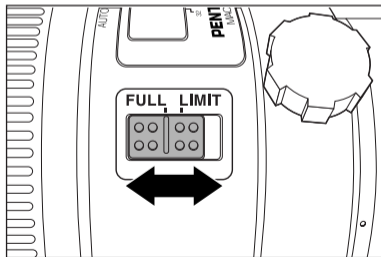
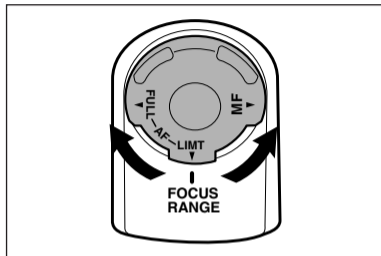

- When the focus range-limiter is set to "MANUAL", you can adjust focus manually.
- The focus range limiter may not turn where the focus range changes between long and short distances.
- Using with the K_{AF2}-mount cameras, manual focus will work with the focus-range limiter is set to MANUAL in autofocus mode.
- FA★ Macro 200mm f/4ED (IF) lens has a focusing ring which provides autofocus and manual focus settings. Push the focusing ring forward or pull to change the focus mode from autofocus to manual.
- With the K_{AF2}-mount camera, when the focusing ring is set to MANUAL, the shutter cannot be released unless the focus indication appears in the view finder if camera is set to the autofocus mode (AF single mode).

Focusing range

Limiter set	Short-distance range	Long-distance range
FA Macro 100mm f/2.8	0.306m(1x) - 0.57m(1/4x)	Approx.0.6m - infinity
FA★ Macro 200mm f/4ED (IF)	0.514m(1x) - 0.7m(1/2x)	Approx.0.7m - infinity

Clamp Screw

FA Macro 50mm f/2.8 and 100mm f/2.8 lenses are equipped with a clamp screw that is used when focusing manually. With manual close-up photography using the copy stand in any situation or with the lens pointing down, if you turn the clamp screw to the ON position, rotation of the focusing ring becomes tight. This helps to prevent the rotation of the focusing ring due to the lens's own weight and avoid any shift in focus.

- When shooting in the autofocus mode, turn the clamp screw to the OFF position. Activating the autofocus mode while the clamp screw is in the ON position slows down the focusing speed.

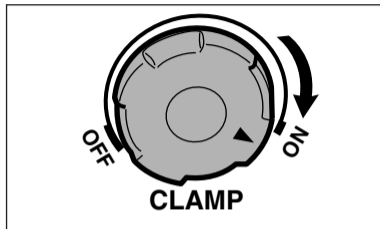

Tripod Mount

FA★ 200mm f/4 ED (IF) is equipped with the tripod mount. To position the camera vertically or horizontally, loosen the camera position shift lock screw, turn the camera 90° to the right or left as desired, and tighten the lock screw firmly.

The tripod mount is not detachable.

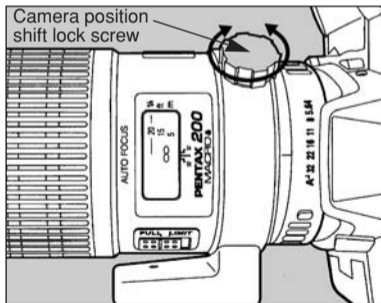

Magnification Scale

The magnification is indicated by denominators on the distance scale. "5" indicates "1/5x". When determining the magnification first, set the magnification in the MANUAL focus mode and adjust the position of the camera by moving the camera closer or further from the subject.

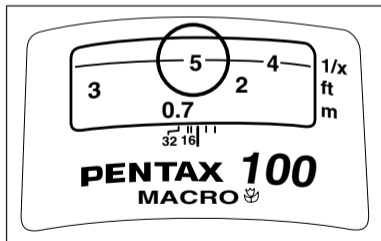

WIDE-ANGLE LENS (FA★ 24mm f/2 (IF))

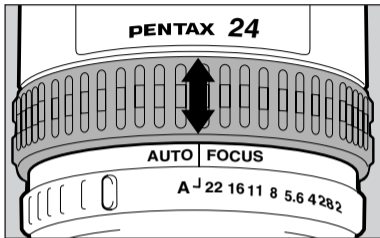

FA★ 24mm f/2 lens has a focusing ring which provides autofocus and manual focus settings. Push the focusing ring or pull it towards you to set the autofocus or manual focus mode respectively.

When used on the K_{AF2}-mount camera, you can use the manual focus mode by setting the manual mode on the lens even if the autofocus mode is set on the camera.

- When the lens is set to manual focus position and the focusing ring is fully rotated to the right or left to manually focus the lens, it will keep rotating as no stoppers are provided at the ∞ or shortest distance positions.
- When the focusing ring on the lens is set to the autofocus position, the focusing ring is released, allowing a full 360° rotation and providing a click stop at each 30° turn.
- When used on the K_{AF}-mount camera, set the same focus mode on the camera and lens. When the camera is set to the autofocus mode (AF single) and the lens is set to the manual mode, the shutter cannot be released unless the focus indication appears in the viewfinder.
- When used on the non-K_{AF2}- or K_{AF}-mount camera, focus the lens manually with the focusing ring.

**TELEPHOTO LENS (FA* 85mm f/1.4(IF), FA* 200mm f/2.8ED(IF), FA* 300mm f/4.5ED(IF)
FA* Macro 200mm f/4ED(IF))**

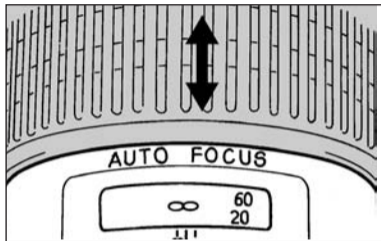

FA* 300mm f/4.5 lens has a focusing ring which provides autofocus and manual focus settings. Push the focusing ring or pull it towards you to set the autofocus or manual focus mode respectively.

When used on the K_{AF2}-mount camera, you can use manual focus mode by setting the manual mode on the lens even if the autofocus mode is set on the camera.

- * The illustration depicts the FA* 300mm f/4.5 lens : when using the FA* 85mm f/1.4, FA* 200mm f/2.8 and FA* Macro 200mm f/4, the operation is similar to the FA* 300mm f/4.5.
- * For FA* 300mm f/2.8 and FA* 600mm f/4 lenses, refer to their own manual, too.

When the lens is set to manual focus position and the focusing ring is fully rotated to the right or left to manually focus the lens, it will keep rotating as no stoppers are provided at the ∞ (infinity) or shortest distance positions.

- When the focusing ring on the lens is set to the autofocus position, the focusing ring is locked.
- When used on the K_{AF}-mount camera, set the same focus mode on the camera and lens. When the camera is set to the autofocus mode (AF single) and the lens to manual focus mode, the shutter cannot be released unless the focus indication appears in the viewfinder.

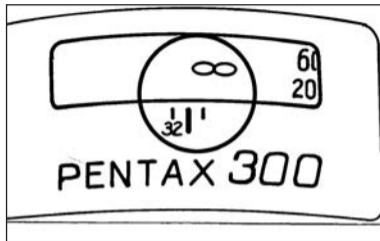

Note : infinity (∞) mark except the FA* 85mm f/1.4 lens

The focusing ring of the telephoto lens stops slightly past the ∞ mark. This is because temperature change causes the focusing point to shift, making the lens focus on a point past the ∞ mark. Even when shooting at infinity, be sure the image is in focus utilizing the focus indicator before releasing the shutter.

Built-in FLASH

With the built-in flash in popped-up position, the flash can be used if no warning indication appears when the shutter release button is pressed halfway down. However, some lenses cause vignetting in the picture corners, even though warning indication does not appear. For more details, refer to page 38 and 39.

- When using the *ist D camera, no warning indication appear in the viewfinder even if you use the incompatible lenses with the built-in flash.
Refer to the lens compatibility with the built-in flash on the *ist D operating manual.
- Remove the lens hood when the built-in flash is used because the flash light will be blocked by the lens hood.

The vignetting will not occur without the lens hood.

	Z Series	MZ Series, *ist	*ist D
Flash A	○	○	○
Flash B	△ (*1)	○	○
Flash C	△ (*2)	△ (*4)	○
Flash D	△ (*3)	△ (*5)	○

Flash A : AF500FTZ, AF360FTZ, AF400FTZ, AF240FT, AF400T

Flash B : AF330FTZ

Flash C : AF280T, AF200T, AF200SA, AF200S

Flash D : AF160, AF140

*1 No vignetting occur at focal distance more than 2.5m.

*2 No vignetting occur at focal distance more than 1.1m with focal length 35mm.

*3 No vignetting occur at focal distance more than 1.8m with focal length 50mm.

*4 No vignetting occur at focal distance more than 1.0m

*5 No vignetting occur at focal distance more than 1.5m with focal length 35mm.

SOFT CASE FOR LENS

Code	Lens
S70-70	FA 20mm f/2.8, FA 28mm f/2.8AL, FA 50mm f/1.4, FA 50mm f/1.7, FA SOFT 28mm f/2.8
S80-80	FA 35mm f/2AL, F Fish-Eye 17-28mm f/3.5-4.5, FA 28-70mm f/4AL, FA 35-80mm f/4-5.6
S80-120	FA 135mm f/2.8 (IF), FA 28-80mm f/3.5-5.6, FA28-90mm f/3.5-5.6, FA 28-105mm f/4-5.6, FA MACRO 50mm f/2.8, FA SOFT 85mm f/2.8, F, FA 80-200mm f/4.7-5.6, FA MACRO 100mm f/3.5
S80-160	FA 70-200mm f/4-5.6, FA 80-320mm f/4.5-5.6, F 100-300mm f/4.5-5.6, FA 100-300mm f/4.7-5.8, FA MACRO 100mm f/2.8
S90-100	FA* 24mm f/2 (IF), FA J18-35mm f/4-5.6AL, FA 20-35mm f/4AL, FA 24-90mm f/3.5-4.5AL (IF), FA J 28-80mm f/3.5-5.6AL, FA 28-105mm f/3.2-4.5AL (IF), FA 28-105mm f/4-5.6 (IF), FA J 75-300mm f/4.5-5.8AL
S90-160	FA 28-200mm f/3.8-5.6AL (IF), FA* 300mm f/4.5ED (IF)
S110-160	FA* 200mm f/2.8ED (IF)
S120-150	FA* 85mm f/1.4 (IF), FA* 28-70mm F2.8AL
S110-210	FA* MACRO 200mm f/4ED (IF)
S110-230	FA* 400mm f/5.6ED (IF)
S120-230	FA* 80-200mm f/2.8ED (IF)
S135-340	FA* 300mm f/2.8ED (IF)
Trunk case	FA* 600mm f/4ED (IF), FA* 250-600mm f/5.6ED

SPECIFICATIONS

•Type	•Lens	•Minimum Aperture	•Angle of View	•Elements-Groups	•Minimum Focus Distance	
					m	ft.
ULTRA-WIDE-ANGLE	FA 20mm f/2.8	22	94°	10-9	0.25	0.80
	FA★ 24mm f/2AL (IF)	22	84°	11-9	0.30	1.00
WIDE-ANGLE	FA 28mm f/2.8AL	22	75°	5-5	0.30	1.00
	FA 31mm f/1.8AL Limited	22	70°	9-7	0.30	1.00
	FA 35mm f/2AL	22	63°	6-5	0.30	1.00
STANDARD	FA 43mm f/1.9 Limited	22	53°	7-6	0.45	1.60
	FA 50mm f/1.4	22	47°	7-6	0.45	1.50
	FA 50mm f/1.7	22	47°	6-5	0.45	1.50
MEDIUM-TELEPHOTO	FA 77mm f/1.8 Limited	22	31.5°	7-6	0.70	2.30
	FA★ 85mm f/1.4 (IF)	22	28.5°	8-7	0.85	2.80
	FA 135mm f/2.8 (IF)	32	18°	8-7	0.70	2.30
TELEPHOTO	FA★ 200mm f/2.8ED (IF)	32	12.5°	9-8	1.20	3.90
	FA★ 300mm f/2.8ED (IF)	32	8.2°	10-7	2.00	6.60
	FA★ 300mm f/4.5ED (IF)	32	8.2°	9-7	2.00	6.60
ULTRA-TELEPHOTO	FA★ 400mm f/5.6ED (IF)	45	6.2°	9-8	2.00	6.60
	FA★ 600mm f/4ED (IF)	32	4.1°	9-7	5.00	16.50
MACRO	FA MACRO 50mm f/2.8	32	47°	8-7	0.195	0.64
	FA MACRO 100mm f/2.8	32	24.5°	9-8	0.306	1.00
	FA MACRO 100mm f/3.5	22	24.5°	5-4	0.43	1.41
	FA★ MACRO 200mm f/4ED (IF)	32	12.5°	12-9	0.514	1.70

- AL = Aspherical lens
- ED = Achromatic lens including elements of the Extra-low Dispersion glass
- IF = Lens featuring the inner focusing mechanism

Specifications and external dimensions are subject to change without notice.

X	•Maximum Magnification	•Max. Diameter × Length	•Weight		•Filter size	•Rear Converter Compatibility			
	mm × mm		g	oz.		mm	1.4 × S		
0.12	70 × 44		255	9.0	67	○	○	×	×
0.12	72.5 × 65.5		405	14.3	67	○	○	×	×
0.13	65 × 40.5		185	6.5	49	○	○	×	×
0.16	65 × 68.5		345	12.2	58	○	○	×	×
0.17	64 × 44.5		195	6.9	49	○	○	×	×
0.12	64 × 27		155	5.5	49	○	○	×	×
0.15	65 × 37		220	7.8	49	○	○	×	×
0.15	65 × 37		170	6.0	49	○	○	×	×
0.14	64 × 48		270	9.5	49	○	○	×	×
0.11	79 × 70		550	19.4	67	○	○	×	×
0.25	68 × 80		375	13.2	52	○	○	×	×
0.20	83 × 134		785	27.7	77	×	○	○	○
0.17	123 × 247		2500	88.2	43(112)‡	○	○	○	○
0.17	72.5 × 160		935	33.0	43	×	○	×	×
0.23	83 × 199		1140	40.2	77	○	○	×	×
0.13	176 × 457		7000†	247.0	43(150)‡	×	×	○	○
1.00	68 × 70		385	13.6	52	○	○	×	×
1.00	74 × 103.5		600	21.2	58	○	○	×	×
0.50	68 × 71.5		220	7.8	49	○	○	×	×
1.00	75.5 × 191.5		1080	38.2	67	○	○	×	×

† = Weight with the tripod mount

‡ = Figures in () of Filter size indicate the thread diameter of the front ring.

Note : Lens length does not include mount portion.

•Type	•Lens	•Minimum Aperture		•Angle of View	•Elements-Groups		
					•Minimum Focus Distance	m	ft.
	*2 F Fish-Eye ZOOM 17-28mmf/3.5-4.5	22-32	180	- 90°	9-7	0.45	1.50
	*1 FA J ZOOM 18-35mmf/4-5.6AL	22-32	100	- 63°	12-10	0.28	0.93
Zoom	FA ZOOM 20-35mmf/4AL	32	94	- 63°	10-8	0.30	1.00
	FA ZOOM 24-90mmf/3.5-4.5AL (IF)	22-32	84	- 27°	13-11	0.50	1.65
	FA* ZOOM 28-70mmf/2.8AL	22	75	- 34.5°	14-11	0.43	1.40
	FA ZOOM 28-70mmf/4AL	22	75	- 34.5°	9-7	0.40	1.30
	FA ZOOM 28-80mmf/3.5-5.6	22-38	75	- 30.5°	8-8	0.50	1.65
*1	FA J ZOOM 28-80mmf/3.5-5.6AL	22-38	75	- 30.5°	8-8	0.40	1.30
	FA ZOOM 28-90mmf/3.5-5.6	22-32	75	- 27°	10-8	0.40	1.30
	FA ZOOM 28-105mmf/3.2-4.5AL (IF)	22-32	75	- 23.5°	12-11	0.50	1.65
	FA ZOOM 28-105mmf/4-5.6	22-32	75	- 23.5°	13-11	0.43	1.40
	FA ZOOM 28-105mmf/4-5.6 (IF)	22-32	75	- 23.5°	15-12	0.50	1.65
	FA ZOOM 28-200mmf/3.8-5.6AL (IF)	22-32	75	- 12.5°	16-14	0.52	1.70
	FA ZOOM 35-80mmf/4-5.6	22-32	63	- 30.5°	7-6	0.40	1.30
	FA ZOOM 70-200mmf/4-5.6	32-45	34.5	- 12.5°	10-8	1.10	3.60
*1	FA J ZOOM 75-300mmf/4.5-5.8AL	32-38	32	- 8.2°	12-10	1.30	4.30
	FA* ZOOM 80-200mmf/2.8ED (IF)	32	30.5	- 12.5°	16-13	1.40	4.60
	FA ZOOM 80-200mmf/4.7-5.6	32-38	30.5	- 12.5°	11-7	1.10	3.60
	F ZOOM 80-200mmf/4.7-5.6	32-38	30.5	- 12.5°	11-7	1.10	3.60
	FA ZOOM 80-320mmf/4.5-5.6	32-38	30.5	- 7.7°	13-10	1.50	4.90
	FA ZOOM 100-300mmf/4.7-5.8	32-38	24.5	- 8.2°	11-9	1.50	4.90
	F ZOOM 100-300mmf/4.5-5.6	32-38	24.5	- 8.2°	12-8	1.50	4.90
	FA* ZOOM 250-600mmf/5.6ED (IF)	32	9.9	- 4.1°	18-16	3.50	11.50

*1 The lens does not have aperture ring to set f-stop, camera body controls aperture on "A" position.

X	•Maximum Magnification		•Weight		•Filter size		•Power zoom		•Rear Converter Compatibility	
	•Max. Diameter × Length		g	oz.	mm	*3	1.4×S	2×S	1.4×L	2×L
0.07	65	× 61	255	9.0	—	×	○	○	×	×
0.18	72	× 68.5	190	6.7	67	×	○	○	×	×
0.16	69.5	× 68	245	8.6	58	×	○	○	×	×
0.18	72	× 74.5	355	12.5	67	×	○	○	×	×
0.25	84.5	× 104	800	28.2	67	○	○	○	×	×
0.23	65.5	× 66	240	8.5	52	×	○	○	×	×
0.19	66.5	× 78	275	9.7	58	×	○	○	×	×
0.25	63	× 67	180	6.3	58	×	○	○	×	×
0.28	66.5	× 67.5	195	6.8	58	×	○	○	×	×
0.19	66	× 65.5	255	9.0	58	×	○	○	×	×
0.33	72.5	× 95.5	515	18.2	58	○	○	○	×	×
0.18	72	× 74	305	10.8	62	×	○	○	×	×
0.21	78	× 83	465	16.4	73	×	○	○	×	×
0.25	66.5	× 58	160	5.6	49	×	○	○	×	×
0.25	73	× 116.5	465	16.4	49	○	○	○	×	×
0.30	69	× 116	385	13.6	58	×	○	○	×	×
0.19	87.5	× 191.5	1570†	55.4	77	○	○	○	×	×
0.25	65	× 97.5	270	9.5	49	×	○	○	×	×
0.25	65	× 97.5	295	10.4	49	×	○	○	×	×
0.28	74.5	× 129	550	19.4	58	×	○	○	×	×
0.26	70	× 128.5	410	14.5	58	×	○	○	×	×
0.25	71.5	× 154.5	605	21.3	58	×	○	○	×	×
0.20	134	× 442	5600†	198.0	43(112)‡	○	×	○	○	○

*2 This lens deliberately emphasizes distortion (barrel aberration) of the images at the picture corners throughout the entire focal length of 17mm to 28mm. This allows you to obtain special effect photographs different from ordinary photographs.

*3 ○ indicates the power zoom lens, × indicates the non-power zoom lens.

•Type	•Lens		•Minimum Aperture	•Angle of View	•Elements-Groups	•Minimum Focus Distance	
						m	ft.
SOFT	FA	SOFT 28mmf/2.8	22	75°	5-5	0.25	0.82
	FA	SOFT 85mmf/2.8	32	28.5°	5-4	0.50	1.65

X	•Maximum Magnification	•Max. Diameter × Length	•Weight		•Filter size	•Power zoom			•Rear Converter Compatibility	
	mm × mm		g	oz.	mm	*3	1.4×S	2×S	1.4×L	2×L
0.13	65.6 × 40.3		195	6.9	49	—	○	○	×	×
0.25	66 × 60		305	10.8	52	—	○	○	×	×

COMPATIBILITY OF LENSES WITH THE BUILT-IN FLASH

[○ = compatible × = incompatible because of vignetting]

The F, FA and FA J lenses which are not shown in the following table can be used with the built-in flash.

Lens name	Compatibility			
	Z/PZ series Cameras *1	*ist*1, MZ series Cameras *1	MZ-S series Cameras *1	*ist D*1
FA 20mm f/2.8	×	×	×	○
FA 24mm f/2 AL (IF)	×	×	○	○
FA★ 300mm f/2.8 ED (IF)	×	×	×	×
FA★ 300mm f/4.5 ED (IF)	○ * 2	○ * 2	○ * 2	×
FA★ 600mm f/4 ED (IF)	×	×	×	×
FA J18–35mm f/4–5.6AL	△ * 3	△ * 3	△ * 4	△ * 23
FA 20–35mm f/4 AL	△ * 5	△ * 5	△ * 6	○
FA 24–90mm f/3.5–4.5 AL (IF)	△ * 7	△ * 8	△ * 9	○
FA★ 28–70mm f/2.8 AL	×	×	△ * 10	△ * 24
FA 28–70mm f/4 AL	△ * 11	○	○	○
FA 28–80mm f/3.5–5.6	△ * 12	△ * 12	○	○
FA J28–80mm f/3.5–5.6 AL	△ * 13	○ * 2	○	○
FA 28–90mm f/3.5–5.6	△ * 13	○	○	○
FA 28–105mm f/4–5.6	△ * 14	△ * 15	○	○
FA 28–105mm f/4–5.6 (IF)	△ * 16	△ * 16	○	○

Lens name	Compatibility			
	Z/PZ series Cameras *1	*ist*1, MZ series Cameras *1	MZ-S series Cameras *1	*ist D*1
FA 28–200mm f/3.8–5.6 (IF)	△ * 17	△ * 17	△ * 18	○
FA★ 80–200mm f/2.8 ED (IF)	△ * 19	△ * 20	○	○ * 25
FA★ 250–600mm f/5.6 ED (IF)	×	×	×	×
F FISH EYE 17–28mm f/3.5–4.5	×	×	×	△ * 26
FA MACRO 50mm f/2.8	○ * 21	○	○	○
FA MACRO 100mm f/2.8	○ * 21	○	○	○
FA★ MACRO 200mm f/4 ED (IF)	△ * 22	○	○	○

* 1 Minimum focal length with the built-in flash.

Z-1, Z-5, Z-10	35mm lens & longer focal length.
*ist, MZ & Z series cameras except MZ-S, Z-1, Z-5 & Z-10.	28mm lens & longer focal length.
MZ-S	24mm lens & longer focal length.
*ist D	18mm lens & longer focal length.

* 2 Vignetting will occur, even if the inappropriate lens warning is blinking.

* 3 Vignetting will occur at focal length between 18mm–28mm.

* 4 Vignetting will occur at focal length between 18mm–24mm and the focus distance is less than 1.5m.

* 5 Vignetting will occur at focal length between 20mm–28mm.

* 6 Vignetting will occur at focal length between 20mm–24mm.

- * 7 Vignetting will occur at focal lengths between 20mm-50mm. With the focal length set at 50mm, it will occur when the camera-to-subject distance is closer than 1m.
- * 8 Vignetting will occur at focal lengths between 24mm-35mm. With the focal length set at 35mm, it will occur when the camera-to-subject distance is closer than 1m.
- * 9 Vignetting will occur at focal lengths between 24mm-28mm.
- * 10 Vignetting will occur at focal lengths between 28mm-35mm. With the focal length set at 40mm, it will occur when the camera-to-subject distance is closer than 1m.
- * 11 With the Z-1_P and Z-5_P camera vignetting will occur at focal length 28mm when the camera-to-subject distance is closer than 1m.
- * 12 Vignetting will occur at focal lengths between 28mm-35mm and focal distance is less than 1m. No vignetting will occur when focal distance is 50mm and/or longer toward tele-side.
- * 13 Vignetting will occur at focal lengths between 28mm-35mm.
- * 14 Vignetting will occur at focal lengths between 28mm-35mm and with the focal length set at 35mm and focus distance is closer than 3m and with 40mm at 1m. No vignetting will occur when the focal length is set at 50mm and/or longer toward tele-side.
- * 15 Vignetting will occur at focal lengths between 28mm-35mm and with the focal length set at 35mm and focus distance is closer than 1.5m and with 35mm.
- * 16 Vignetting will occur at focal lengths between 28mm-40mm.
- * 17 Vignetting will occur at focal lengths between 28mm-70mm.
- * 18 Vignetting will occur at focal lengths between 28mm-35mm and focus distance is less than 1m at 35mm.
- * 19 Vignetting will occur at focal lengths between 80mm-135mm.
- * 20 Vignetting will occur at focal lengths between 80mm-90mm.

- * 21 Even the Lens warning is blinking with Z-1, Z-5 and Z10, built-in flash can be used if the focus distance is more than 0.7m which is within distance of Minimum Auto flash distance.
 - * 22 Vignetting will occur at focus distance less than 1m.
Even the Lens warning is blinking with Z-1, Z-5 and Z10, built-in flash can be used freely at focus distance more than 1m.
 - * 23 Vignetting may occur at focal lengths 18mm and the shooting distance within 1m.
 - * 24 Vignetting may occur at focal lengths between 28-35mm and the shooting distance less than 1m.
 - * 25 Vignetting may occur at focal lengths between 80-90mm.
 - * 26 Vignetting may occur at focal lengths less than 20mm.
-

STATEMENT OF FCC COMPLIANCE

This device complies with Part 15 of the FCC Rules. Operation is subject to the following two conditions : (1) This device may not cause harmful interference, and (2) this device must accept any interference received, including interference that may cause undesired operation.

Changes or modifications not approved by the party responsible for compliance could void the user's authority to operate the equipment.

This equipment has been tested and found to comply with the limits for a Class B digital device, pursuant to part 15 of the FCC Rules. These limits are designed to provide reasonable protection against harmful interference in a residential

installation, This equipment generates, uses and can radiate radio frequency energy and, if not installed and used in accordance with the instructions, may cause harmful interference to radio communications. However, there is no guarantee that interference will not occur in a particular installation. If this equipment does cause harmful interference to radio or television reception, which can be determined by turning the equipment off and on, the user is encouraged to try to correct the interference by one or more of the following measures :

- Reorient or relocate the receiving antenna.
- Increase the separation between the equipment and receiver.

- PENTAX Corporation** 2-36-9, Maeno-cho, Itabashi-ku, Tokyo 174-8639, JAPAN (<http://www.pentax.co.jp/>)
- PENTAX Europe GmbH (European Headquarters)** Julius-Vosseler-Strasse, 104, 22527 Hamburg, GERMANY (HQ - <http://www.pentaxeurope.com>) (Germany - <http://www.pentax.de>)
- PENTAX U.K. Limited** PENTAX House, Heron Drive, Langley, Slough, Berks SL3 8PN, U.K. (<http://www.pentax.co.uk>)
- PENTAX France S.A.S.** 12/14, rue Jean Poulmarch, 95106 Argenteuil Cedex, FRANCE
- PENTAX Benelux B.V.** (for Netherlands) Spinveld 25, 4815 HR Breda, NETHERLANDS (<http://www.pentax.nl>) (for Belgium & Luxembourg) Weiveldlaan 3-5, 1930 Zaventem, BELGIUM (<http://www.pentax.be>)
- PENTAX (Schweiz) AG** Widenholzstrasse 1 Postfach 367 8305 Dietlikon, SWITZERLAND (<http://www.pentax.ch>)
- PENTAX Scandinavia AB** P.O. Box 650, 75127 Uppsala, SWEDEN (<http://www.pentax.se>)
- PENTAX Imaging Company**
A Division of PENTAX of America, Inc.
(Headquarters)
600 12th Street, Suite 300 Golden, Colorado 80401, U.S.A.
(Distribution & Service Center)
16163 West 45th Drive, Unit H Golden, Colorado 80403, U.S.A. (<http://www.pentaximaging.com>)
- PENTAX Canada Inc.** 1770 Argentia Road Mississauga, Ontario L5N 3S7, CANADA (<http://www.pentax.ca>)



This Class B digital apparatus meets all requirements of the Canadian Interference-Causing Equipment Regulations.

Cet appareil numérique de la classe B respecte toutes les exigences du Règlement sur le matériel brouilleur du Canada.

Only the power zoom lenses are subject to comply with Part 15 of FCC Rules and the Canadian Interference-Causing Equipment Regulation.



The CE Mark is a Directive conformity mark of the European Community.

Free Manuals Download Website

<http://myh66.com>

<http://usermanuals.us>

<http://www.somanuals.com>

<http://www.4manuals.cc>

<http://www.manual-lib.com>

<http://www.404manual.com>

<http://www.luxmanual.com>

<http://aubethermostatmanual.com>

Golf course search by state

<http://golfingnear.com>

Email search by domain

<http://emailbydomain.com>

Auto manuals search

<http://auto.somanuals.com>

TV manuals search

<http://tv.somanuals.com>