

PENTAX®

zoom 90·WR

zoom 90·WR DATE

OPERATING MANUAL

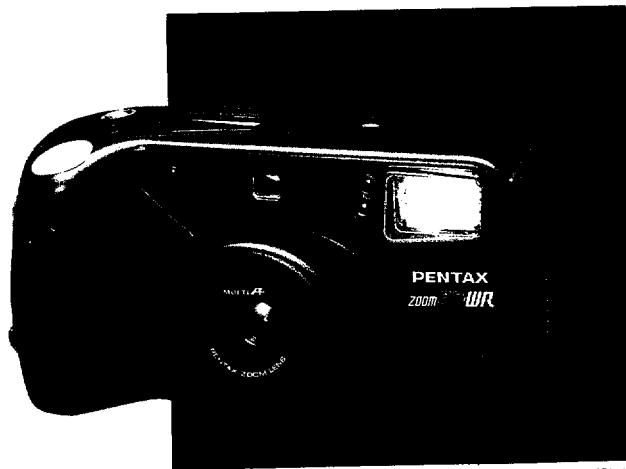







Welcome to the world of Pentax zoom compact photography! Your compact, light weight camera with weather-resistant capability is a great companion to preserve your favorite memories. Its built-in 38-90mm zoom lens gives you the freedom to frame everything from breathtaking landscapes to family portraits, even detailed close-ups. The built-in auto flash helps you capture subjects in a dimly-lit places or indoor scenes with clarity and brilliance, and functions as a fill-in flash for daylight flash-sync photography. Since most of the operations - including film loading, film speed setting, winding/rewinding, focus and exposure control - are automatic, you can take great pictures with little effort. The DATE model makes it easy to remember the dates when you took pictures.

- Please read this manual carefully before operating the camera to take consistently superior pictures.
- Pay special attention to the cautions and notes in this Operating Manual. Pictures and illustrations shown herein may differ from the camera's actual appearance.

The names of the camera's working parts are listed on the front and back flaps of this manual. Keep the flaps unfolded for quick reference while reading the manual.

Icon indicators used in this manual

Operation direction	
Automatic operation	
Attention	
Lamp lighting	
Lamp blinking	
Correct	
Incorrect	

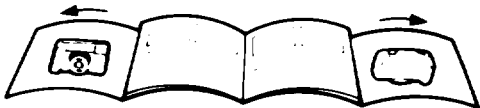

NAMES OF WORKING PARTS

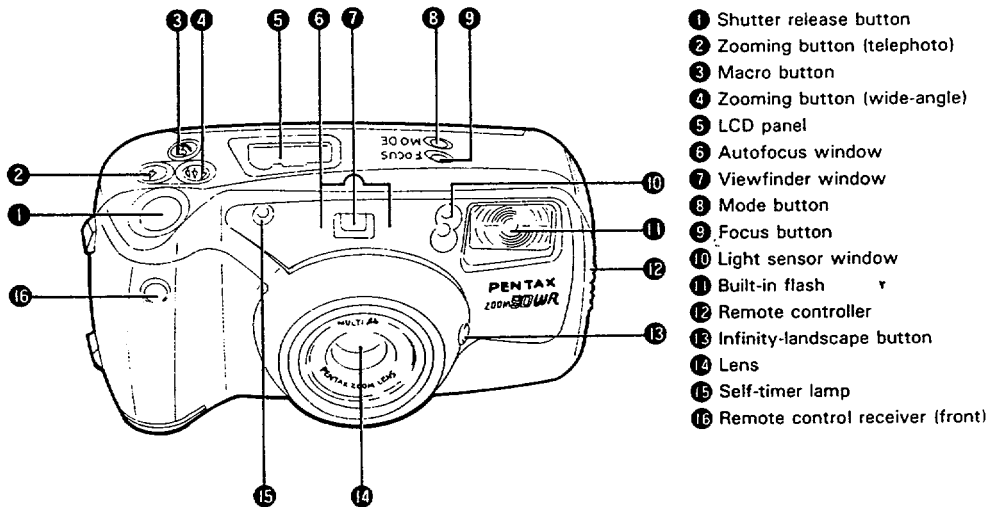

TABLE OF CONTENTS

• Cautions	1
• Weather-resistant capability	2
• Outline of basic operations	4

PREPARATIONS BEFORE TAKING PHOTOGRAPHS

1. Strap attachment	5
2. Main switch and battery check	6
3. How to hold the camera	7
4. Operating 38 - 90mm zoom lens	8

TAKING PHOTOGRAPHS

1. Usable film	9
2. Film loading	10
3. Viewfinder displays and shooting ranges	12
4. Green/red lamps	13
5. Ordinary photography	13
6. Taking pictures (Multi-beam AF)	14
7. Spot AF shooting	16
8. Infinity-landscape shooting	18
9. Unloading film	19

TAKING BETTER PHOTOGRAPHS

Taking macro pictures	20
How to select modes/Red-eye reduction flash mode	22
Daylight-synchro shooting	24
Taking pictures at slow shutter speed	24
Bulb, bulb-synchro shooting	26
Self-timer photography	28
Consecutive photography	29
Multi-exposure shooting	30
Interval shooting	31
Using the wireless remote controller	33
Date model	37

MAINTENANCE CONSIDERATIONS

Battery exhaustion warning	40
Replacing the batteries	41
Taking care of your camera	42
Troubleshooting	44
Specifications	46
Warranty policy	48
LCD panel	51

CAUTIONS

- The electric circuitry inside the camera contains high voltage working parts. Never attempt to disassemble the camera.
- Be careful not to drop it or subject the camera to strong vibrations, shock or pressure.
- Do not apply force to the zoom lens; do not place the camera with the lens facing down.
- Make sure not to obstruct the autofocus window, lens, light sensor window, built-in flash with your fingers or hair.
- Avoid leaving the camera for extended periods where temperature and humidity are high such as in a car.
- Never use solvents such as paint thinner, alcohol or benzene to clean the camera.
- Read through the instructions on weather-resistant capability before using.
- The misuse of batteries causes hazards such as leakage, heating, explosions, etc. Batteries should be inserted with the "+" and "-" sides facing correctly.
- Do not mix battery brands, types or old battery with new ones. Otherwise, overheating or fire might result.
- Never try to break up, short or recharge the batteries. Also, do not dispose of the battery in fire, as the battery may explode.
- Keep the batteries out of reach of children, infants and pets.



WEATHER-RESISTANT CAPABILITY



This camera is weather-resistant and can be used without having to be bothered by rain or water spray.

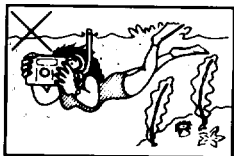

However, it is not designed for underwater photography.

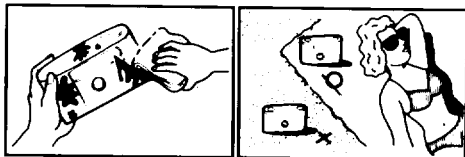

- After use wipe off any dirt or water droplets on the camera with a clean, soft and dry cloth.
- Sand or mud entering the camera may damage the camera. If used at the beach or other sandy or dirty area, do not place it directly on the sand or dirty area.

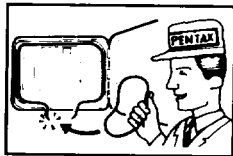

- Remove any dirt or sand from the weather-resistant seals. If the lens barrel or the seals are damaged, they will not keep the camera weather-resistant. Have your factory authorized service agent replace these seals as soon as possible.

- If there is dirt or saltwater droplets on the camera after use, remove the dirt off the camera or wash it clean in slowly running tap water or in a vessel filled with water **after making sure that the main switch is turned off and the back cover and battery chamber cover are closed. Wash it in water for a maximum of 2-3 minutes. NEVER press the zooming button to zoom the lens while the camera is in water to be washed clean.**
- This camera is not designed to withstand water pressure. Never leave the camera in water for a long time or wash it clean in a vessel where the hydraulic pressure is high.
- Never use solvents such as soapy water, detergent or alcohol to clean the camera. Otherwise, the camera's weather-resistant capability will be impaired.
- The camera inside is not weather-resistant. The camera will be damaged if sand, dust or water enters the camera while changing the film or replacing the batteries. Note that in this case repairs of such damages will be chargeable to you even during the warranty period.

OUTLINE OF BASIC OPERATIONS

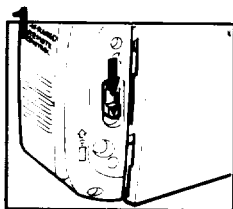

Open the back cover (see page 10).

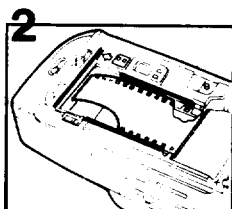

Load the film and close the back cover (see page 10).

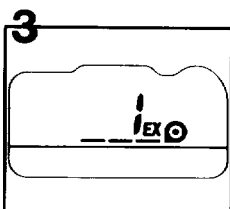

The film will automatically advance to the first frame (see page 11).

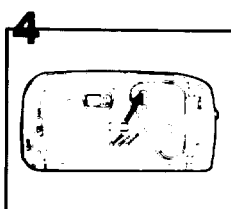

Push the main switch to switch on power (see page 6).

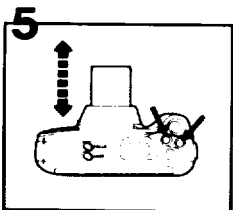

Frame your subject and operate the zooming button to compose the shot (see page 8).

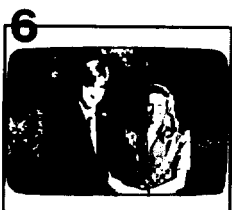

Focus on your subject (see page 14).



Press the shutter release button. In dark conditions, the flash discharges automatically (see page 15).

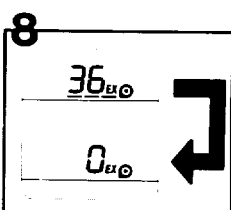

When the film reaches its end, the camera will automatically rewind it (see page 19).

PREPARATIONS BEFORE TAKING PHOTOGRAPHS

You should be aware of certain fundamentals to make it easier to use this camera in the best way.

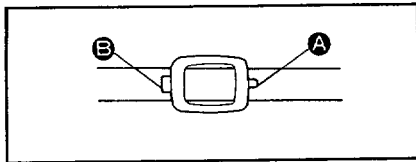

1. STRAP ATTACHMENT

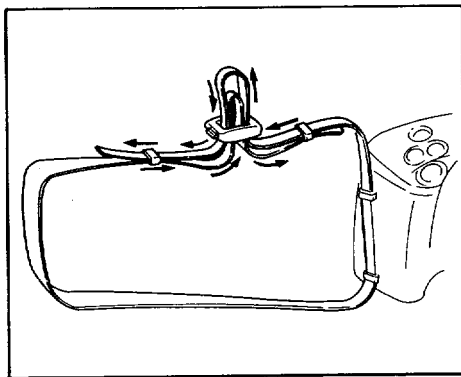

Fit the strap on the camera as illustrated. Use the clamp's protrusion **A** to press the auxiliary rewind button or the ADJUST button on the date model. Use protrusion **B** to open the battery chamber cover.

- To prevent the camera from swaying excessively while walking, adjust the strap so the camera rides above your waist.

2. MAIN SWITCH AND BATTERY CHECK

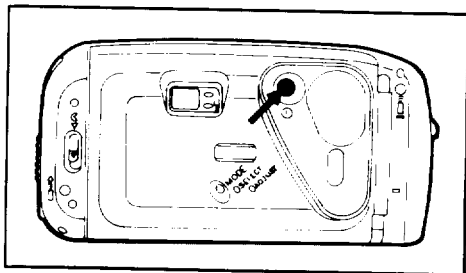

Main switch

To switch on, push the main switch. The lens extends slightly to the wide-angle 38mm setting and LCD panel is on. To switch off, push the main switch again. Make sure the camera is switched off when not in use. Use two 3V lithium batteries, type DL123A or CR123A.

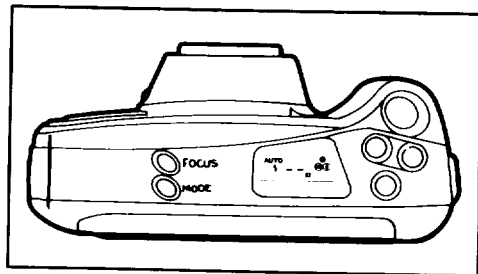

Battery check

After you turn the main switch ON, the lens slightly extends and you are ready to shoot. [See page 40 when the battery exhaustion symbol () appears on the LCD panel.]

- If the camera is left unused for over 3 minutes when the main switch is on, the lens automatically retracts and the power switches itself off to save battery power.
- Refer to page 41 for directions on battery insertion.

3. HOW TO HOLD THE CAMERA

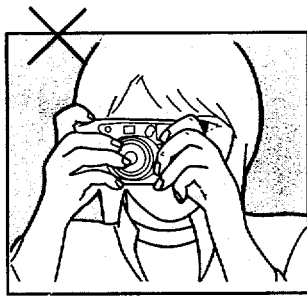
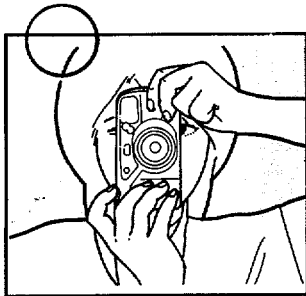
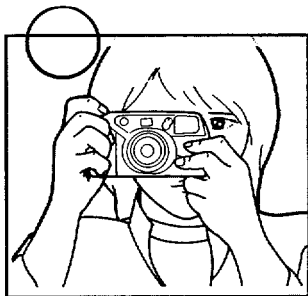

When shooting, hold the camera securely with both hands. Keep the camera as still as possible, and gently press the shutter release button. (If too much force is applied, the camera is likely to shake, and the picture will be blurred.) Try to brace your elbows against your body, or support yourself and the camera against a stable, stationary object, such as a wall. When using the flash with the camera positioned vertically, hold the camera so that the flash is above the lens.

Caution:

Do not hold the zoom lens because it moves back and forth when zooming.

Note:

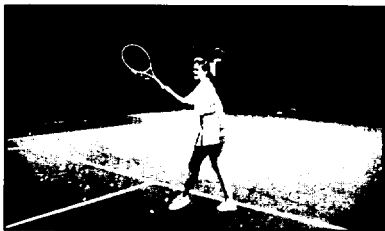

- Make sure not to obstruct the autofocus window, lens, light sensor window or built-in flash with your fingers or hair.

4. OPERATING 38-90 mm ZOOM LENS

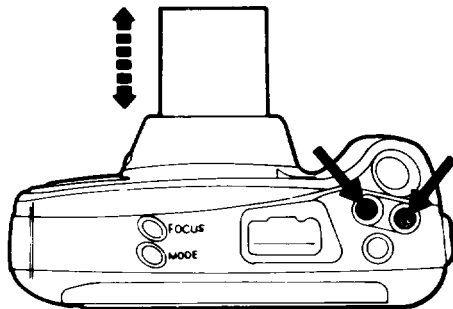

8



When you press the zooming button (), the lens frames the subject more closely, moving towards the 90mm telephoto setting. When you press the zooming button (), the lens moves towards the wider-angle 38mm setting. When the lens zooms to the desired setting, release the zooming button and press the shutter release button all the way down to take pictures.

Note:

- When you press either zooming button, the lens focal length is displayed on the LCD panel. The lens focal length is also displayed when the shutter release button is pressed halfway down. (The shutter cannot be released when zooming.)

TAKING PHOTOGRAPHS

After familiarizing yourself with operations on the camera by reading this instruction manual, you're ready to insert the film.

1. USABLE FILM

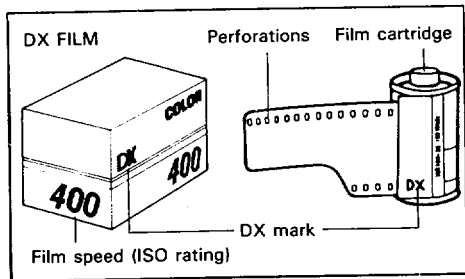

Automatic film speed setting

This camera is designed to use DX-coded films with ISO ratings from 25 to 3200. When any of these films are loaded, the proper film speed is automatically set for the camera.

Notes:

- When buying DX-coded films, make sure the package bears the "DX" mark.
- Non-DX coded film cannot be used.
- Use high-speed film with an ISO rating of 1000 or higher mainly for shooting indoors or in dimly-lit conditions.

2. FILM LOADING

Make sure the power is off before inserting the film.

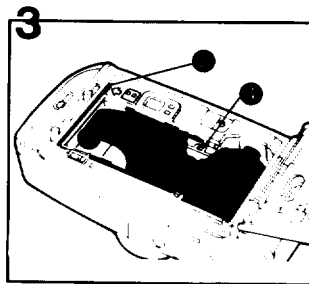
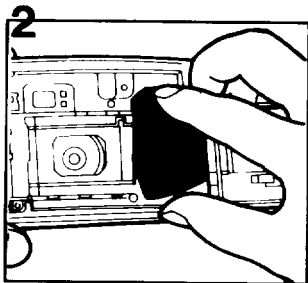
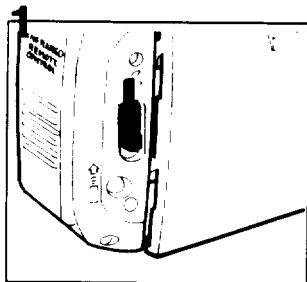

- 1 Slide the back cover release lever down in the direction of the arrow to open the back cover as illustrated.
- 2 Place the film cartridge in the film chamber by fitting its flat side on top of the rewind shaft first and then slide the top end into the camera.
- 3 Pull the film leader out far enough from the cartridge to reach the take-up spool. Align the tip with the film leader end mark (↩) .

Notes:

- Make sure the film is properly placed between the guide rails ●.
- If there is dirt on the film detection section ●, film cannot be wound properly.



✗ Slack NO !



○ Flat YES !

- Make sure the film is taut as illustrated. Take up any slack in the film by pushing it back into the cartridge.
- If the end of the film leader is extremely bent, straighten it or cut off the bent portion.

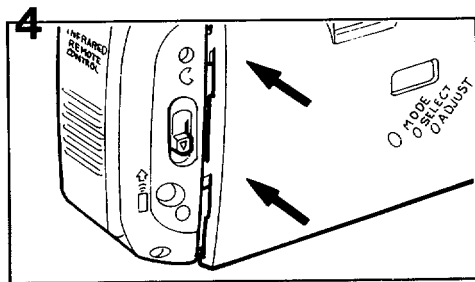

- 4** Make sure there is no sand or water on the seal or your hands before closing the back cover. Make sure that the two tabs in the back cover firmly lock in place when the back cover is closed. The camera will not be weather-resistant if the cover is imperfectly closed and it may also let in light. The film automatically advances to the first frame.
- Even if no film is loaded, the motor operates for a second or two after the back cover is closed.

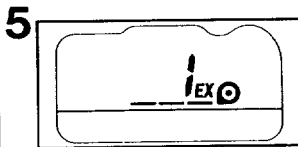

- 5** When (|) appears in the exposure counter on the LCD panel, the film automatically stops winding. The indication as shown above appears. If (|) blinks on the LCD panel, it indicates that the film is not properly loaded. If this occurs, reload the film.
- The exposure counter indication will remain on even if the main switch is turned off.



3. VIEWFINDER DISPLAYS AND SHOOTING RANGES

First, switch on power by pressing the main switch.

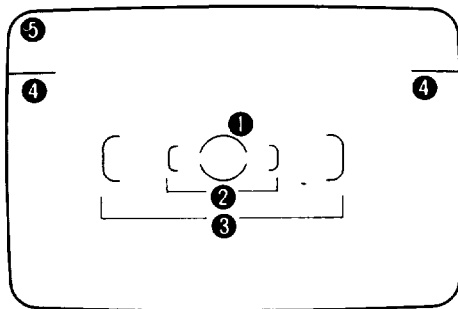

- 1 Spot AF frame
- 2 Multi-beam AF frame (wide-angle)
- 3 Multi-beam AF frame (telephoto)
- 4 Macro frame
When taking a macro picture, compose the picture within this frame.
- 5 Picture area
When taking a normal picture, compose the picture within this frame.

Autofocus is referred to as "AF".

Shooting ranges (effective camera-to-subject distance)

- The ordinary setting allows a shooting range from ∞ (infinity) to 0.8 meter (2.6 ft).
- The macro setting allows a shooting range from 0.8 meter (2.6ft) to 0.5 meter (1.6ft). No subjects closer than 0.5 meter (1.6ft) can be clearly photographed.

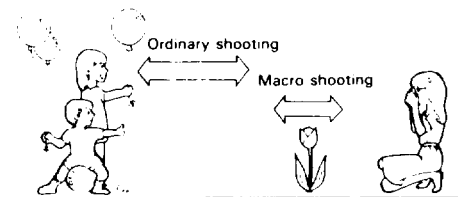

4. GREEN/RED LAMPS

When you press the shutter release button halfway, the lamps ① and/or ② light up or blink as shown above.

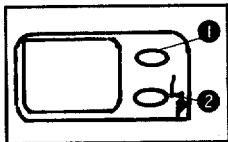

- ① Green lamp: When the subject is in focus, it lights up to indicate that you can take pictures; when the subject is not in focus, it will blink, indicating that you cannot take pictures.
- ② Red lamp: When the flash is ready to discharge, it will light up. When the flash is being charged, it will blink.

Notes:

- If the subject is too close, the green lamp blinks. Adjust the camera-to-subject distance so that the green lamp lights up, then release the shutter.
- If the subject is even closer, the green lamp may light up.

5. ORDINARY PHOTOGRAPHY

When the power is switched on by pressing the main switch, the camera automatically selects the Auto and Single-Frame Shooting modes and the LCD

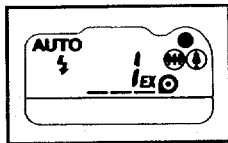

panel indication appears as shown above. These modes are used for taking ordinary pictures. The built-in flash will discharge automatically when the subject is poorly illuminated or backlit.

- When the LCD panel displayed is other than the one as shown above, which indicates the other modes are set, switching power OFF and then ON restores the Auto and Single-Frame Shooting modes.
- * When the built-in flash automatically discharges, the shutter speed ranges from approx. 1/40th sec. [wide-angle] to approx. 1/55th sec. [telephoto] (when ISO100 film is used). So be very careful to hold the camera steady to eliminate the possibility of fuzzy pictures due to camera movement while the shutter is open.

6. TAKING PICTURES Shooting distance: 0.8m(2.6ft) - ∞ (infinity)



- 1 After zooming the lens and composing your shot, focus on the subject with the multi-beam AF frame.

Notes:

- When the power is switched on, the multi-beam AF mode is automatically set.
- The lens focuses on the closest subject in the multi-beam AF frame.
- The shutter cannot be released while the lens is zooming.

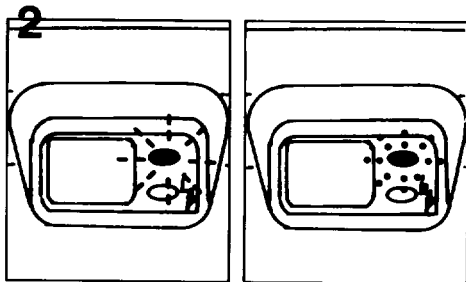

- 2 Press the shutter release button halfway with your subject in focus, and the green lamp lights up. If the subject is closer than 0.8 meter (2.6ft), the green lamp blinks and the shutter cannot be released. In this case, lengthen the camera-to-subject distance.

Notes:

- If you wish to focus on another subject, lift your finger off the shutter release button and press the shutter release button halfway again.
- When the green lamp blinks, the macro symbol (Ⓜ) on the LCD panel also blinks to recommend use of the macro mode (see page 20.).

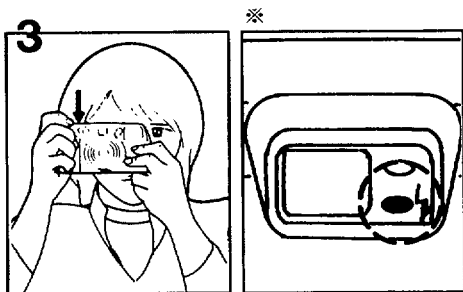

- 3 Press the shutter release button all the way down, and the shutter is released. Then, the film automatically advances to the next frame.

Notes:

- When the shutter is released, the self-timer lamp lights up momentarily to indicate that a picture has been taken.
- Water drops or dirt on the lens protective glass, autofocus window and light sensor window will prevent you from taking good pictures. Clean them before taking pictures.



※ Automatic Flash Emission

When taking pictures in low light or backlit situations, the flash automatically discharges. When the shutter release button is pressed halfway in the low light, the red lamp lights up, indicating the flash is ready to discharge. If the red lamp blinks, this indicates that the built-in flash is being charged. Therefore, make sure the red lamp lights continuously before taking pictures.

Red-eye

Shooting portraits with the flash may result in "red-eye", the red dot in your subject's eye. This camera includes red-eye reduction flash function, which suppresses the red-eye phenomenon by using preflash. See page 23 for details.

Flash-effective ranges (Nega-color film used)

Lens	ISO	100	200	400
38mm ()		0.8-5m	0.8-7m	0.8-10m
90mm ()		0.8-3m	0.8-4.2m	0.8-5.9m
Macro ()		0.5-0.8m	0.5-0.8m	0.5-0.8m

7. SPOT AF SHOOTING

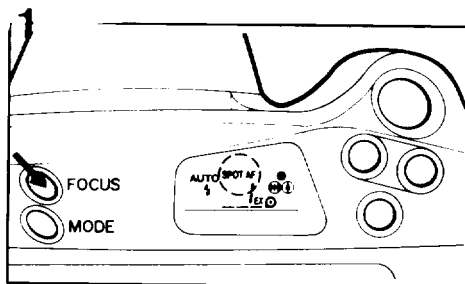

Select the spot AF mode to focus on a particular spot in the frame.

1 Switch to Spot AF mode

Push the FOCUS button to switch to the Spot AF mode. The [SPOT AF] indication is displayed on the LCD panel, letting you know that the Spot AF mode has been set. To clear this mode, push the FOCUS button again.



2 Focus on the subject.

Focus on the subject with the Spot AF frame () (for Spot AF) in the center of the viewfinder.

- When the main subject of your picture is off the AF frame in the center of the viewfinder, use the focus-lock technique (see page 17).
- The lamp and picture-taking indications are similar as explained for multi-beam AF.

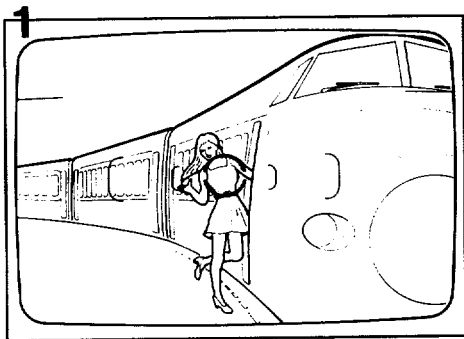

FOCUS-LOCK SHOOTING

- 1 Focus on the subject with the AF frame (○). When the shutter release button is pressed halfway down, the green lamp on the right-hand side of the viewfinder lights up and the exposure and focus are temporarily locked.

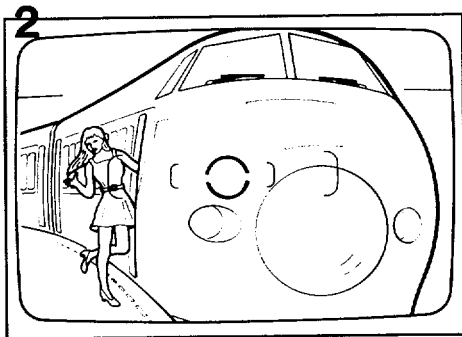

- 2 While pressing the shutter release button halfway, re-aim the camera or recompose the picture, then release the shutter.

Notes:

- You can release focus lock simply by lifting your finger off the shutter release button.
- When in the Consecutive Shooting mode (), the focus lock function cannot be used.

8. INFINITY-LANDSCAPE SHOOTING

Hard-to-autofocus subjects

Like many other autofocus cameras, the camera's autofocus system is highly precise, but not perfect, so some subjects may not focus as you wish. In such a case, use the focus-lock technique on a subject near the actual one and equidistant from the lens. Subjects which may fool the system include:

1. Black objects like hair, which don't reflect much light (and therefore don't reflect infrared autofocus beams).
2. Wire netting, latticework, iron exercise-bars, etc.
3. Flickering light sources such as neon signs, fluorescent lamps, TV images, sunlight coming through trees, etc. and subjects illuminated by these light sources.
4. Glossy and reflective surfaces like glass, mirrors, car bodies, etc.
5. Fast-moving objects, like trains in motion.
6. Water jets, water surface, smoke, flame, fireworks, etc., which have no distinct or consistent form, or a subject in mist.

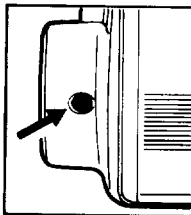

When you wish to take a sharp picture of a distant landscape or a distant subject through a window, releasing the shutter while keeping the infinity-landscape button depressed allows you to take distant scenery with clarity.

- If the green lamp lights up after you press the shutter button halfway while keeping the infinity-landscape button pressed, the infinity-landscape mode is locked even if you raise your finger off the infinity-landscape button.
- To use the infinity-landscape mode, first press the infinity-landscape button and then the shutter release button while pressing the infinity-landscape button.
- When taking pictures in low light, switch to slow-shutter-speed mode (Flash-OFF mode) (see page 24).

TAKING BETTER PHOTOGRAPHS

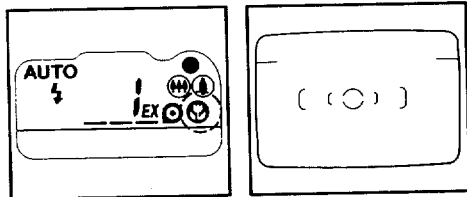

This shooting mode is used to take close-up pictures. When the macro symbol (🔍) appears on the LCD panel, you can take macro pictures. When shooting a subject about 0.5-0.8 meter (1.6-2.6 ft) away, compose the shot within this macro frame.

TAKING MACRO PICTURES



Notes

- In macro photography, the autofocus frame is not in the center of the viewfinder. So use the focus-lock technique described in "Focus-lock shooting" on page 17 when taking macro pictures.
- The green lamp blinks when the distance is closer than 0.5m, but may light up when the camera-to-subject distance is even shorter.

HOW TO SELECT MODES/RED-EYE REDUCTION FLASH MODE

To select various exposure modes, press the MODE button ①.

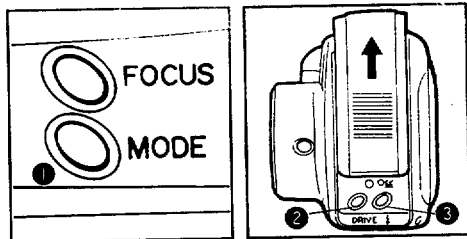
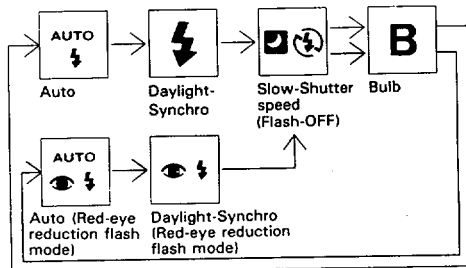

- Pressing the red-eye reduction flash button (⚡) ③ in the Auto or Daylight-Sync mode alternates the normal mode (indicated by black line) with the red-eye reduction flash mode (indicated by red line).
- Press buttons ① and/or ② in succession to set the required modes. To switch to the next mode from the Bulb, Bulb-synchro, Interval shooting, press the corresponding button (① or ②) twice in quick succession. For normal use, set the Auto and Single-Frame modes as shown.
- When the power is switched on, the Auto and Single-Frame Shooting modes are automatically set.

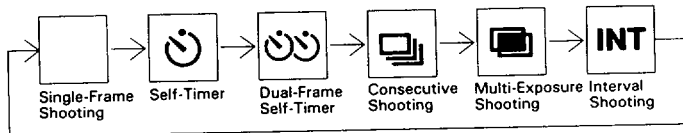

To select the desired shooting modes, press the drive button ②.

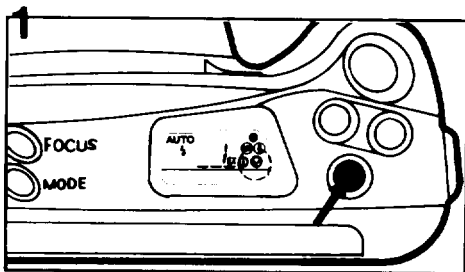

- 1** Press the macro button to set the Macro mode, and the lens moves forward and the (🔍) symbol appears on the LCD panel. To cancel the Macro mode, just press either zooming button (🔍) or (🔍). The ordinary shooting mode is then restored.

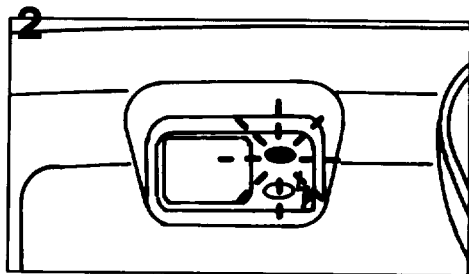

- 2** The macro shooting range is 0.5-0.8 meter (1.6-2.6ft). Press the shutter release button halfway, making sure the green lamp lights up, and then release the shutter.

If you press the shutter release button halfway down while composing the subject at a distance of more than 0.8m (2.6ft) in macro mode, the macro mode will automatically shift to the 90mm telephoto setting. Press the shutter release button all the way down to shoot. The macro mode is restored after the picture is taken.

- In the Slow Shutter speed mode, if the red-eye reduction flash button (⚡) ③ is pressed, the desired mode is set as shown on the right.

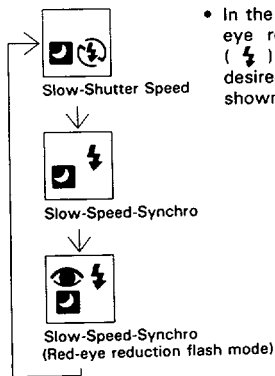

- In the Bulb mode, if the red-eye reduction flash button (⚡) ③ is pressed, the desired flash mode is set as shown on the right.

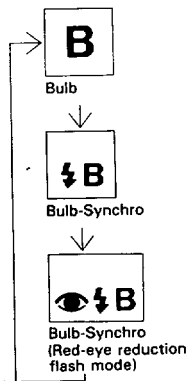

- In the Slow-Shutter Speed, Slow-Speed-Synchro, Bulb or Bulb-Synchro mode, if the mode button ① is pressed, the exposure mode changes as in the normal mode.
- In the Slow-Speed-Synchro and red-eye reduction flash modes or the Bulb-Synchro and red-eye reduction flash modes, if the mode button ① is pressed, the exposure mode changes as in the red-eye reduction flash mode.

RED-EYE REDUCTION FLASH MODE

With the Red-eye reduction flash mode, the flash discharges two consecutive times. The first flash discharges just before the shutter is released (low-power output) which causes the irises of the eyes to close down (contract). Then, the second flash discharges (normal flash output), which reduces the possibilities of the red-eye effect significantly.

DAYLIGHT-SYNCHRO SHOOTING

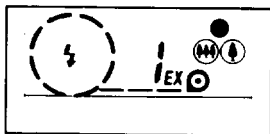

Press the mode button until the (⚡) appears on the LCD panel. The flash will discharge both in dark and bright conditions.

When the portrait is taken even if the subject is not in backlit situation, the front of your subject may be cast in shadow. In such a case, use the Daylight-Synchro Shooting mode (Flash-ON mode) within the appropriate flash-effective range to take pictures. This will ensure that a picture is beautifully exposed without any shadow. The flash will always discharge in this mode.

Notes:

- Make sure the red lamp on the right-hand side of the viewfinder eye-piece lights up when the shutter release button is pressed halfway down before shooting. A red lamp blinking indicates that the flash is being charged.
- Make sure you're within the flash-effective distance range even when you use the built-in flash as a fill-flash in daytime.

TAKING PICTURES AT SLOW SHUTTER SPEED

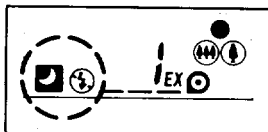

Slow Shutter Speed (Flash-OFF)

Press the mode button until the (⚡+) symbol appears on the LCD panel.

In this mode, the flash does not discharge, and a picture is taken at a slow shutter speed up to approx. 1/5 second. Use it in places where using flash is prohibited, such as in theaters, museums, etc. Furthermore, this mode is also useful when you wish to take a lit picture with a natural effect.

Notes:

- When shooting in darkness, the shutter speed gets slower, and camera shake is more likely to blur your picture, so use a tripod
- If the shutter release button is pressed halfway down and the symbol (⚡+) on the LCD panel blinks, switch to Auto Shooting mode to take the picture. Otherwise, you cannot take a good picture due to insufficient light.

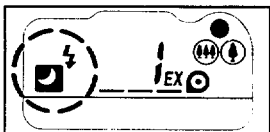

Slow-Speed-Synchro Shooting (Flash-On)

If the red-eye reduction flash button (⚡) is pressed in the Slow Shutter Speed mode, the Slow-Speed-Synch flash mode is set. It is possible to take a picture of subjects and background in a balanced way as shown in the photo by using the built-in flash to properly expose the foreground subject and the slow-shutter-speed to expose the low light background.



BULB, BULB-SYNCHRO SHOOTING



Bulb mode,
approx. 4 sec. (ISO100)

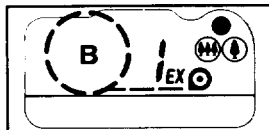

Bulb mode (B)

Press the mode button until (B) appears on the LCD panel. The shutter

remains open up to 10 min. as long as the shutter release button is held down. This mode is useful for long exposures required for shooting fireworks and night scenes, for instance. When using this mode, the camera should be mounted on a tripod so that the camera will be steady.

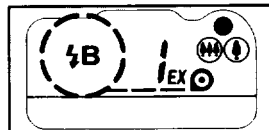

Bulb-synchro mode (B)

If the red-eye reduction flash button (⚡) is pressed in the Bulb mode, Bulb-

synchro mode is set. This lets you use the flash in addition to the Bulb mode, so you can take a portrait with a night scene in the background, for example.

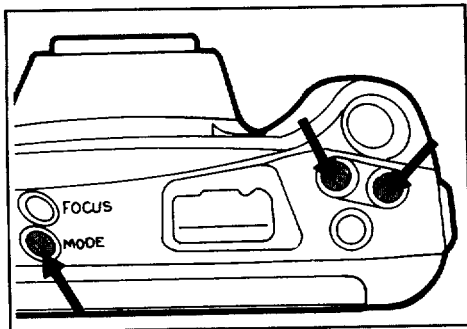

Bulb-Timer mode

When shooting in the Bulb or Bulb-Synchro mode, a shutter speed of 1, 2, 3, 4, 5, 6, 7, 8, 10, 15, 20, 30, 40, 50, 60, 90 sec., 2, 3, 4, 5, 6, 7, 8, 10 minutes can be set. [Example: 1S = 1 sec., 2M = 2 min.]

To select the shutter speed in the Bulb or Bulb-Synchro mode, first select the Bulb or Bulb-Synchro mode. Then, while pressing the mode button as shown in the illustration, and while the symbol (**B**) is blinking on the LCD panel, press either zooming button to select the required shutter speed. (Each time the zooming button is pressed, the shutter speed advances by one setting. If the zooming button is kept depressed, the shutter speed setting will be fast forwarded.)

If the zooming () button is pressed, the indication advances to the 10 min. setting.

If the zooming () button is pressed, the indication decreases to the 1 sec setting.

Notes:

- If the timer setting is blank in the Bulb-Timer mode, this indicates the camera is in the Bulb mode. To switch the exposure mode from the Bulb (**B**) or the Bulb Synchro mode () to the next, press the mode button twice in quick succession.
- To cancel the Bulb-Timer mode before the shutter is released completely, press the main switch. In this instance, the power is not switched off.
- Use the Bulb-Timer mode if you wish to take consecutive pictures in the Bulb mode.

SELF-TIMER PHOTOGRAPHY

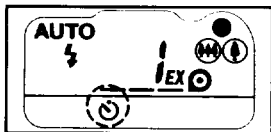

Self-Timer

Use the self-timer if you wish to take a picture of yourself. Use of a tripod is recommended. Press

the drive button until the (Ⓢ) appears on the LCD panel.

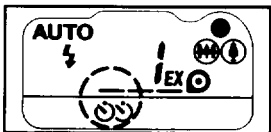

Dual-Frame Self-Timer

In this mode, you can take two consecutive self-timer pictures.

Press the drive button until the (Ⓢ) symbol appears on the LCD panel. Press the shutter release button. The first frame will be exposed after approx. 10 seconds, then the second frame approx. 5 seconds after the first. Note that focus for both shots is locked at the first frame.

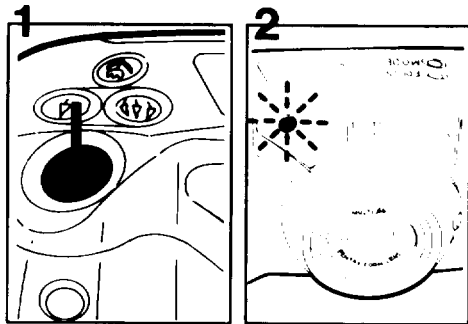

- 1 Focus on the subjects first by pressing the shutter release button halfway, and then depress the shutter release button all the way down. The shutter will be released in about 10 seconds.
- 2 When the Self-Timer is working, the Self-Timer symbol (Ⓢ) blinks on the LCD panel, and the Self-Timer lamp lights up. The lamp starts blinking 3 seconds before the shutter is released, letting you know when to smile.

CONSECUTIVE PHOTOGRAPHY

Notes on Self-Timer and Dual-Frame Self-Timer:

- * To cancel the self-timer after it has been started, press the main switch. In this instance, the power is not switched off.
- * When combined with (B), (⚡B) or (👁️⚡B), the shutter will be released in approx. 1/2 sec.
- * When using flash, make sure the flash is charged (the red lamp lights up) before operating either timer feature.
- * When the battery symbol (🔋) appears on the LCD panel, the camera may not operate. If this occurs, replace the batteries (see page 41).

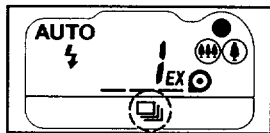

Press the drive button until the (📷) symbol appears on the LCD panel. While the shutter release button is held down, a frame is shot every 1.6 sec. Moving subjects such as a running person, etc., can be shot. The camera focuses on the subjects frame by frame in this mode, so make sure to keep the autofocus frame on the subject.

Note:

- When using flash in this mode, consecutive shooting is possible only after the flash is charged (the red lamp lights up) following each exposure.



MULTI-EXPOSURE SHOOTING

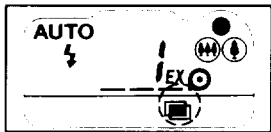

Multi-Exposure mode will disengage the film advance, letting you superimpose images on a single frame for fantastic illusions. Your imagination can produce striking creative effects.



Procedure

1. Press the drive button until the symbol () appears on the LCD panel.
2. Press the shutter release button to shoot an initial exposure. The film will not advance, the frame advance symbol () blinks on the LCD panel to indicate that you are in the Multi-exposure mode. The normal Single-Frame Exposure mode will be restored after the picture is taken.
3. Recompose the frame, and press the shutter release button to shoot the second exposure. (After the second shot, the film will be advanced.)

To expose more than twice:

Activate the Multi-Exposure symbol before pressing the shutter release button for the second exposure. After the last exposure, the film will wind to the next frame.

Notes:

- The date will be exposed in step 3 above.
- Repeated multiple exposures tend to overexpose a frame, so it is recommended that you expose a frame just twice or 3 times at most.
- When using Multi-Exposure, you can usually get the best results with dimly-lit backgrounds, such as night scenes.

INTERVAL SHOOTING

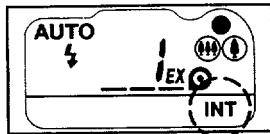

Press the drive button until the (INT) mark appears on the LCD panel. This mode allows you to shoot with an interval selectable

between 10 seconds and 1 hour. It is ideal for observational photography of animals, insects or plants, etc.

[Example: 10S = 10sec. 60M = 60min.]

The selectable shooting intervals are 10, 20, 30, 40, 50, and 60 seconds and 2, 3, 4, 5, 10, 20, 30, 40, 50, 60 minutes.

To select the shooting interval, press either zooming button while pressing the drive button until the required interval time appears on the LCD panel. The preset interval time is 60 seconds. (When the zooming button is kept depressed, the interval time will be fast forwarded.)

- (Ⓜ) Pressed to advance to the 60 minutes setting.
- (Ⓜ) Pressed to decrease to the 10 seconds setting.

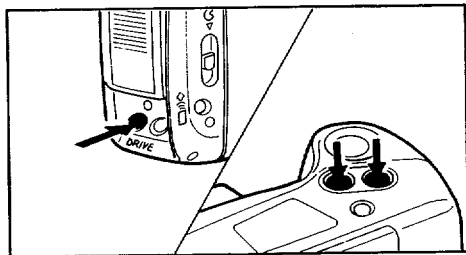

After the selection, press the shutter release button; the first frame will be exposed 3 seconds later. Then the rest of the film will be automatically exposed according to the interval time selected.

Notes:

- When in the Interval Shooting mode, the interval shooting mark (INT) blinks on the LCD panel and the remaining time of the interval is also displayed.
- To cancel the Interval Shooting mode after it has been activated, press the main switch. In this instance, the power is not switched off.
- The exposure counter indication appears on the LCD panel when the shutter release button is pressed halfway.

Notes on the Interval Shooting

- The minimum shooting interval time varies according to the Exposure mode to be set as follows.

Exposure mode	Minimum shooting interval
(1) Auto or Daylight-Synch Shooting	More than 20 sec.
(2) Slow Speed Shutter	More than 10 sec.
(3) Bulb shooting	Exposure time plus 8 sec. or more
(4) Bulb-synch shooting	Exposure time plus 15 sec. or more

- Use a tripod when shooting in the Interval Shooting mode. The focus will be locked at the first frame, and the self-timer lamp starts blinking 3 seconds before the shutter is released.
- To switch to other modes from the Interval Shooting mode, press the drive button in quick succession.



USING THE WIRELESS REMOTE CONTROLLER

This camera is equipped with a Wireless Remote Controller, allowing you to adjust the focal length in steps of 38, 60, 90mm at a distance and release the shutter.

- Use a tripod when shooting with the Remote Controller.
- When the Remote Controller is used for taking picture, only the Single-Frame Shooting or the Self-Timer mode can be set on the camera. Either mode can be combined with any of the exposure modes.
- Attach the Remote Controller to the camera when not in use.
- Use the Remote Controller to take pictures in the Bulb mode to avoid camera shake.

Removing the Remote Controller

Slide out the Remote Controller in the direction of the arrow while pressing the Remote-Controller-release button.

After it is removed, the () symbol appears on the LCD panel to indicate that it can now be used.

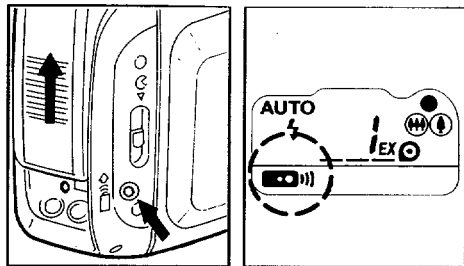

Name of parts

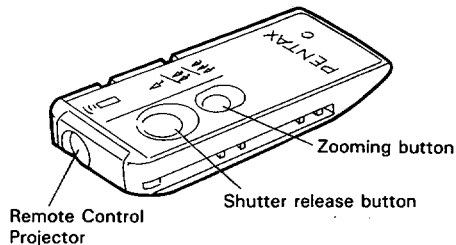

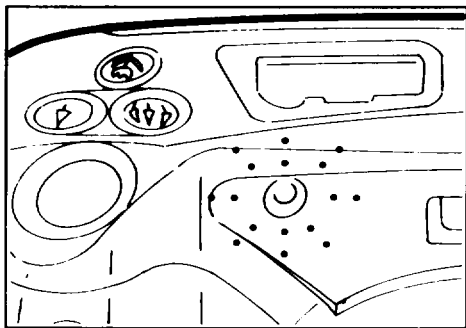

Blinking Lamp

After the Remote Controller is removed, the self timer lamp on the front of the camera blinks slowly, indicating that you can take pictures with the aid of a Remote Controller.

- When the camera is left unused for more than 10 minutes with the Remote Controller removed, the camera automatically switches itself off to save battery power. Push the main switch again to turn it on.

Selection of Shooting Mode

Set the Single-Frame Shooting or the Self-Timer mode by pressing the drive button.

Single-Frame Shooting mode: you can take a picture without any delay by pressing the shutter release button located on the Remote Controller.

Self-Timer Shooting mode: the shutter will be released in 3 seconds if the shutter is released with the Remote Controller; if the shutter is released by the camera's release button, pictures will be taken in the ordinary Self-Timer Shooting mode.

Compose the picture

Compose the picture and frame the subject with the AF frame. When the shutter release button is pressed halfway down, the green lamp lights up and the focus is locked. Even if you lift your finger off the shutter release button, the focus will remain locked for 10 minutes and the green lamp will blink slowly.

- * If you wish to focus on another subject after the focus is locked, use the focus-lock technique again to focus on the subject.
- * Focus lock is unlocked when the Remote Controller is attached to the camera.
- * When the focus is not locked, the subject framed in the AF frame will be in focus when the Remote Controller's shutter release button is pressed.
- * In the macro mode, the focus lock function cannot be used for subjects more than 80cm away. Cancel macro mode to take pictures.

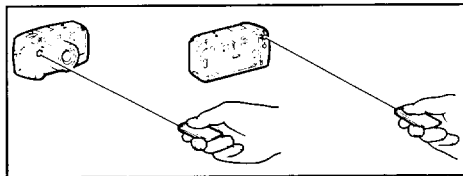

Taking Pictures

Aim the Remote Control Projector towards the Remote Control Receiver on the camera, and then press the Remote Controller's shutter release button to release the shutter.

- * If the Self-Timer mode is set on the camera, the Self-Timer lamp blinks for 3 seconds quickly and then the shutter is released.

Operating Distance of the Wireless Remote Controller

From the camera's front: within approx. 5m right from the front of the camera

From the camera's rear: within approx. 0.7m right from the center of the back

- * Remote Controller may not function when the subject is backlit. In this case, use the Self-Timer mode to take pictures.

Zooming using the Remote Controller

When the Remote Control Projector is aimed towards the camera's Remote Control Receiver, each time you press the zooming button, the lens zooms and stops at steps of 90, 60, and 38mm focal length settings continuously.

- * When using the Remote Controller to zoom the lens, frame the subject through the viewfinder, assuming the setting of the zoom lens is 90mm telephoto setting. Otherwise, the subject will be out of the picture area.
- * You may zoom the lens in and out to change the picture area with the Remote Controller while the focus is being locked.
- * The lens cannot zoom in and out in the macro mode using the Remote Controller.

Attaching the Remote Controller

Attach the Remote Controller to the camera after use. Slide the Remote Controller until it locks in place with a click.

Battery life on the Remote Controller

About 30,000 commands can be issued using the Remote Controller with a battery installed in the Remote Controller. Have exhausted battery replaced at the Pentax Service center located nearest you if the battery is exhausted (service is chargeable).

- * Never disassemble the Remote Controller. Otherwise, you may damage the weather-resistant parts.

DATE MODEL

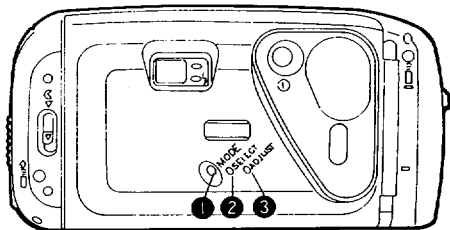

If you purchased the DATE model, read this section. The DATE model records dates up to the year 2019 on pictures.

- ① MODE button
- ② SELECT button
- ③ ADJUST button

Switching the Mode

At each press of the MODE button ① with your fingernail, the mode in the LCD panel switches as shown in the chart.

Notes:

“-----” indicates no data will be imprinted.

- “M” on the LCD panel indicates “Month”.
- Use the strap tool’s pin-shaped protrusion to press the SELECT and ADJUST buttons.

Year Month Day

Day Hour Minute

Month Day Year

Day Month Year



* The date in the picture above is simulated.

Correcting the date

1. Press the SELECT button ● to make a different category of digits in the LCD panel you want to change to blink.
 2. Press the ADJUST button ● to change digits of the specified category you chose with the SELECT button ●. Digits increase by one each time you press the ADJUST button ●. Holding down the button will advance digits continuously.
 3. After the data has been adjusted, press the SELECT button. The bar mark (–) appears on the LCD panel, indicating that data imprinting choices are possible.
- If you release the shutter while the blinking data is being corrected, the data cannot be imprinted.
 - Numerical indication
Year = 87-19 (1987-2019)
Month = 1-12
Day = 1-31
Time = 0-23
Minute = 00-59
 - The blinking “:” allows precise fine-tuning of the internal clock to the beginning of a specified minute. To do so, press the SELECT button ● to make the “:” blinking, and then press the ADJUST button ● in sync with a time signal. After the data has been adjusted, press the SELECT button. The bar mark (–) appears on the LCD panel, indicating that data imprinting choices are possible.

OPERATIONAL PRECAUTIONS

The data on the LCD panel is imprinted on each frame you expose.

- “Year-Month-Day” and “Day-Hour-Minute” cannot both be imprinted at the same time.
- As you release the shutter, the bar mark (–) on the display blinks for a few seconds, indicating the data has been imprinted.
- If there is a white or yellow object in the corner of the picture where the data is imprinted, the data may be difficult to read. When composing your photographs, try to avoid brightly-colored subjects in that corner.

Replacing the battery for data imprinting section

The imprinting section is powered by one CR2025 3V Lithium battery. When the displays in the LCD cannot be seen clearly or when the watch function becomes unstable, replace the battery with a new one. The battery will last for about 3 years.

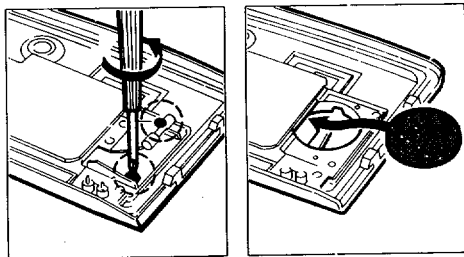

- * Make sure that no film is loaded by checking the film information window, before opening the back cover.
1. Loosen the two battery cover fixing screws with a Phillips screwdriver, and then remove the battery chamber cover.
 2. Replace the old battery with a new battery with the + side facing up.
 3. Reinstall the battery chamber cover, and tighten the two battery cover fixing screws.

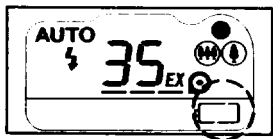

- * When the battery is set correctly, Data will be displayed. Reset the data according to "Correcting the date and time" after replacing the battery.
- * Keep the battery out of reach of children, infants and pets.

BATTERY EXHAUSTION WARNING



When the batteries are nearly exhausted, the battery symbol () appears on the LCD panel to warn you. Replace the batteries as soon as possible. When () starts blinking, no operations can be performed.

Battery life (using 24-exposure film rolls):

Ordinary picture taking mode, 50% of shooting employs flash	Approx. 30 rolls
--	------------------

(The CR123A batteries were used in our own testing conditions. Actual battery life/performance may vary drastically depending on either usage of Auto-Focus, Power Zoom and Flash and external conditions such as temperature and freshness.)

Notes on replacing the batteries:

- Make sure there is no film loaded. Switch off power before replacing the battery.
- If the battery is replaced with a film already loaded, the camera enters the starting mode. It will assume the film has been just loaded and will advance several frames. The "1" will appear on the LCD panel.
- If the battery is replaced at the end of the film roll, the camera may not detect the film, and the frame counter indication may not appear on the LCD panel. Press the auxiliary rewind button to rewind the film, and remove the film.
- Battery performance may temporarily deteriorate in low temperatures, but it will recover in normal temperature.
- Keep spare batteries on hand for convenience when shooting outdoors or while traveling.
- When the camera is in a bag, make sure the main switch is off: otherwise, battery power may be wasted if the shutter release button is pushed accidentally.

REPLACING BATTERIES Use two 3V lithium batteries (CR-123A or DL-123A)

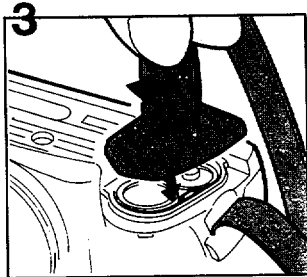
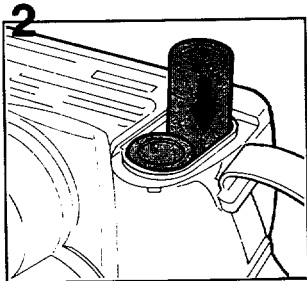
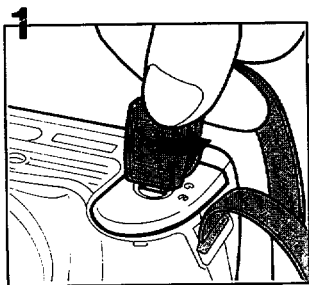

Remove sand or water on the camera or your hands, if any, before replacing the batteries. Make sure that the power is off before replacing the batteries.

- 1 Open the battery chamber cover by rotating the cover lock in the direction of the arrow as shown.
- 2 Insert two lithium batteries, aligning the batteries with the "+" or "-" indication.
- 3 Make sure that the groove of the battery chamber lock is aligned with the (⊗) mark. Press in the cover and then rotate the cover lock counter-clockwise to secure it in place.

If the battery is correctly loaded, the zoom lens moves slightly and the motor operates for a few seconds.

Caution:

Replace all batteries at the same time. Do not mix battery brands, types or old batteries with new ones. Otherwise, explosion or overheating might result.

TAKING CARE OF YOUR CAMERA

Your Pentax camera is a sophisticated, precision instrument built to give long-lasting, reliable service. It should serve you well if you handle and take care of it properly.

- The surface of the lens barrel is specially coated so the zoom lens can smoothly zoom in and out. Never use solvents such as alcohol, paint thinner or benzine to clean it. If there is dirt, wipe it off with a cloth moistened with water, and then with a soft dry cloth.
- Be careful not to subject it to strong vibrations, shock or pressure. Use a cushion to protect the camera when carrying in a motorcycle, car, boat, etc.
- Use a blower and lens brush to remove dust accumulated on the lens or viewfinder.
- Avoid storing the camera in a wardrobe where a mothball is put among the clothes or in a laboratory containing chemicals that can cause serious damage to it. Keep it in a cool, dry, well-ventilated place.
- Avoid leaving the camera for extended periods in places where temperature and humidity are high, such as in a car.

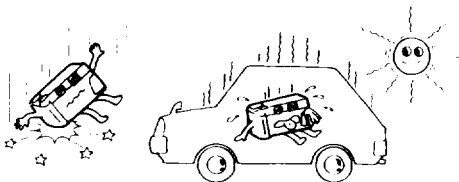

- If the camera is brought into a warm room from the cold outdoors, condensation may occur in the inside and on the outside of the camera. In such a case, put the camera into a case or plastic bag so that change in temperature will be as gradual as possible. After the temperature difference is minimized, take it out of the bag.

- The temperature range in which the camera functions properly is 50°C to -10°C (122°F to 14°F).
- Electrical problems may often be caused by water, dirt or dust at points of electrical contact. Also check for battery leakage, traces of dirt or grease, or corrosion due to salinity or gas. If you cannot correct the problem, have your camera inspected at a Pentax service center.
- Do not apply force to the zoom lens. Never place the zoom lens with the mount side facing down.
- Regular size color prints may cut off what appears on the extreme edges of the film frame. Compose your picture with a margin of safety at the edges.

- To maintain optimum performance, it is recommended that the camera be inspected every one or two years. If the camera has not been used for an extended period, or is being readied for an important photography, it is recommended that you inspect the camera or test shoot with it.
- Repairs made necessary due to usage of this product in an industrial application may not be covered under the terms of the Pentax warranty.

Red-eye phenomenon in flash shooting

When a picture is taken using a flash, a subject's eyes may appear red in the print. This phenomenon is caused by the reflection of the electronic flash in the retina. It can be reduced when the surroundings of the subject are brightened, or shooting distance is shortened with the lens set at the wide-angle position or by employing the red-eye reduction flash feature.

TROUBLESHOOTING

What appears troublesome may be easily remedied. Here are some problems that may occur and their remedies.

Symptoms	Causes and Remedies
1. The shutter cannot be released.	<ul style="list-style-type: none"> • Is the main switch turned off? If so, turn it on. (See page 6.)
	<ul style="list-style-type: none"> • Are the batteries exhausted or loaded? Replace them or insert new batteries if they are exhausted. (See page 41.)
	<ul style="list-style-type: none"> • Is your subject out of the focusing range? Shoot in the range of 0.8 meter to infinity for ordinary photography. (See page 12.)
	<ul style="list-style-type: none"> • Is (U_{REG}) blinking on the LCD panel? If so, the film has been used up. Insert a new roll. (See page 19.)
2. My printed pictures don't look very clear.	<ul style="list-style-type: none"> • Did you position the autofocus frame on your subject? (See page 14.) • Did you obstruct the autofocus window with your fingers or hair when you pressed the shutter release button? (See page 7.) • Water drops or dirt on the lens protective glass, autofocus window and light sensor window will prevent you from taking good pictures. Clean them before taking pictures. (See page 15.)
3. Zoom lens retracted automatically (the power is turned off automatically).	<ul style="list-style-type: none"> • Did you leave the camera unused for over 3 minutes after the main switch was turned on? The power is automatically switched off if the camera is left unused for over 3 minutes. (See page 6.) • Was the Remote Controller removed from the camera? When the camera is left unused for more than 10 minutes with the Remote Controller removed, the camera automatically switches itself off to save battery power. Push the main switch again to turn it on. (See page 34.)

Symptoms	Causes and Remedies
4. The Remote Controller does not operate.	<ul style="list-style-type: none"> The operable distance of the Remote Controller is approx. 5m from the front and approx. 0.7m from the back of the camera. (See page 35.) The Remote Controller may not operate in backlit situation. (See page 35.)
5. The flash discharges, though it is not dark.	<ul style="list-style-type: none"> The flash discharges automatically in backlit situations. (See page 13.)
6. The [H] or [U] mark is displayed on the LCD panel.	<ul style="list-style-type: none"> If either mark disappears when the zoom button is pressed, the camera is ready for use. The camera may be defective if either mark appears often. The correct camera-to-subject distances when shooting using flash with films other than ISO 100, 200 or 400 are indicated in the table below.

Lens	ISO 25	50	1000	1600	3200
38mm (⊕)	0.8-2.5m	0.8-3.5m	1.5(*)-16m	2(*)-20m	3(*)-28m
90mm (⊖)	0.8-1.5m	0.8-2.1m	0.8-8.6m	0.8-11m	0.8(*)-15m
Macro (⊙)	0.5-0.8m	0.5-0.8m	—	—	—

(*) With high speed film overexposure may occur at close range.

(—) Proper exposure cannot occur.

SPECIFICATIONS

Type: 35mm fully automatic leaf-shutter camera with built-in zoom lens and auto flash, Weather-resistant with IEC 529: Second characteristic numeral 5, protected against water jets.

Film: Auto film speed setting with 35mm perforated DX-coded film with ISO rating from 25 to 3200 (1 EV step). Non-DX coded films are automatically set to ISO25. 24x36mm format.

Film loading: Auto film loading. Closing the back cover will automatically wind the film to first exposure.

Film winding: Auto film-winding: Two auto film-winding modes; single frame mode and consecutive mode (approx. 1.6 sec./frame).

Film rewinding: Auto start at the end of roll. Auto stop upon completion of rewinding. Rewinding time: approx 20 sec. with 24-exposure film. Rewinding in mid-roll provided.

Frame number: Automatic readout of successive frame numbers in ascending order when shooting, and descending order when rewinding.

Lens: Pentax power zoom 38-90mm f/3.5-7.5 8 elements in 7 groups, Angle of view: 59°-27°.

Focusing system: Pentax infrared active multi-beam autofocus with focus lock, Switchable to spot AF mode, Range: 0.8m (2.6ft) - infinity; 0.5m (1.6ft)-0.8m (2.6ft) in MACRO (magnification approx. 1/4.5X), Infinity-landscape mode (focus is fixed to infinity).

Zooming: 2-button type.

Shutter: Programmed AE electronic shutter with speeds approx. 1/400 sec.-1/5sec. Bulb 1/2sec.-10min.), Bulb-timer (1sec.-10 min). Electromagnetic release.

Self-timer: Electronic red lamp indication. Approx. 10-sec. delay with LED indication. Cancellation after activation is possible. 2 consecutive shots provided in Dual-frame self-timer mode.

Viewfinder: Actual image zoom viewfinder: 82% field-of-view ratio, Magnification: approx. 0.47X (38mm WIDE)-1.01X(90mm TELE), 0.96X(Macro), Diopter:fixed at -1 diopter, AF frame (Spot AF, Multi-beam AF, WIDE, TELE), Picture frame, Macro frame, Green lamp lighting: in-focus signal, Green lamp blinking: close-distance warning, Red lamp lighting: Flash-ready status, Red lamp blinking: Flash being charged.

Exposure control: Programmed auto-exposure control. Range: EV9-16.5 at 38mm WIDE, EV11.5-16.5 at 90mm TELE and MACRO in Auto or Daylight-Synchro mode (ISO 100), EV6-16.5 in 38mm WIDE, EV8-16.5 in 90mm TELE and MACRO mode in Slow-Shutter-Speed or Interval Shooting mode.

Multi-exposure: Multiple exposure function provided.

Exposure-meter switch: The exposure meter is turned on when the shutter release button is pressed halfway.

Flash: Built-in zoom flash with red-eye reduction mode, Automatic low-luminance firing in Auto mode, Flash-ON = Daylight-Synchro/Slow-Shutter-Speed Synchro (up to 1/5 sec.), Flash-OFF = Flash override, Bulb-Synchro = 1/2sec.-10min.

Flash-effective range: 0.8-5m (38mm WIDE), 0.8-3.0m(60mm TELE), 0.5-0.8m(MACRO) (ISO100 film used)

Recycle time: Approx. 3 sec. in Pentax testing conditions.

Interval shooting: Electronically controlled, started by pressing the shutter release button.

Remote controller: Infrared wireless remote controller, Step zooming at TELE, 60mm, WIDE, Effective range: 5m from the front when projected from the camera's front; 0.7m from the back when projected from the rear.

Power source for Remote Controller: One 3V lithium battery CR1620 (replaced by the Pentax Service facility)

Size & weight for Remote Controller: 26(W)x61(H)x8.8(D), 1" x2.4" x0.3" 11g (0.4 oz.)

Power source: Two 3V lithium batteries (CR-123A or DL-123A)

Battery life: Approx. 30 rolls of 24 exposure film when 50% of shooting employs flash.

Battery exhaustion warning: () appears on the LCD panel, Shutter is locked when the () is blinking.

Data mechanism: Crystal quartz controlled; LCD with digital clock, auto calendar.

Imprinting mode: "Year, Month and Day", "Day, Hour and Minute" or blank.

Power source for data section: Lithium battery CR2025.

Size & weight: 149(W)x76(H)x63.5(D)mm(5.99"x3"x2.5")

440 grams (15.5 oz.) without battery.

DATE model 149(W)x76(H)x66(D)mm(5.9"x3"x2.6")

455 grams (16 oz.) without battery.

SPECIFICATIONS ARE SUBJECT TO CHANGE AT ANY TIME WITHOUT NOTIFICATION OR ANY OBLIGATION ON THE PART OF THE MANUFACTURER.

WARRANTY POLICY

All Pentax cameras purchased through authorized bona fide photographic distribution channels are guaranteed against defects of material or workmanship for a period of twelve months from date of purchase. Service will be rendered, and defective parts will be replaced without cost to you within that period, provided the equipment does not show evidence of impact, sand or liquid damage, mishandling, tampering, battery or chemical corrosion, operation contrary to operating instructions, or modification by an unauthorized repair shop. The manufacturer or its authorized representatives shall not be liable for any repair or alterations except those made with its written consent and shall not be liable for damages from delay or loss of use or from other indirect or consequential damages of any kind, whether caused by defective material or workmanship or otherwise; and it is expressly agreed that the liability of the manufacturer or its representatives under all guarantees or warranties, whether expressed or implied, is strictly limited to the replacement of parts as hereinbefore provided. No refunds will be made on repairs performed by non-authorized Pentax service facilities.

Procedure During 12-month Warranty Period

Any Pentax which proves defective during the 12-month warranty period should be returned to the dealer from whom you purchased the equipment or to the manufacturer. If there is no representative of the manufacturer in your country, send the equipment to the manufacturer, with postage prepaid. In this case, it will take a considerable length of time before the equipment can be returned to you owing to the complicated customs procedures required. If the equipment is covered by warranty, repairs will be made and parts replaced free of charge, and the equipment will be returned to you upon completion of servicing. If the equipment is not covered by warranty, regular charges of the manufacturer or of its representatives will apply. Shipping charges are to be borne by the owner. If your Pentax was purchased outside of the country where you wish to have it serviced during the warranty period, regular handling and servicing fees may be charged by the manufacturer's representatives in that country. Notwithstanding this, your Pentax returned to the manufacturer will be serviced free of charge according to this procedure and warranty policy. In any case,

however, shipping charges and customs clearance fees are to be borne by the sender. To prove the date of your purchase when required, please keep the receipts or bills covering the purchase of your equipment for at least a year. Before sending your equipment for servicing, please make sure that you are sending it to the manufacturer's authorized representatives or their approved repair shops, unless you are sending it directly to the manufacturer. Always obtain a quotation for the service charge, and only after you accept the quoted service charge, instruct the service station to proceed with the servicing.

The warranty policy does not apply to Pentax products purchased in the U.S.A., UK, or Canada. The local warranty policies available from Pentax distributors in those countries supersede this warranty policy.

NAMES OF WORKING PARTS (BACK)

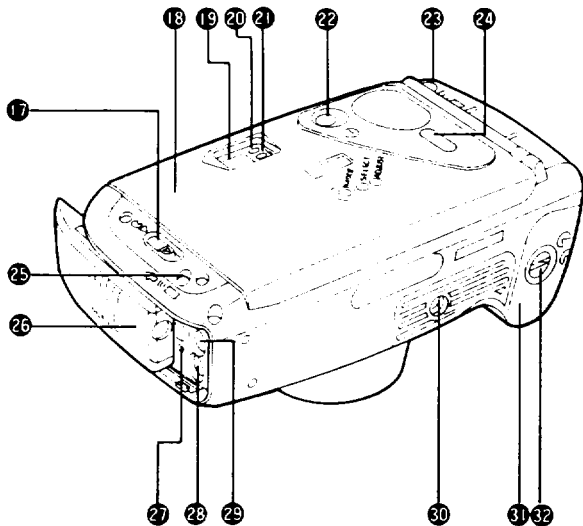

- 17 Back cover release lever
- 18 Back cover
- 19 Viewfinder eyepiece
- 20 AF (Green) lamp
- 21 Flash (Red) lamp
- 22 Main switch
- 23 Remote control receiver (rear)
- 24 Film information window
- 25 Remote-controller-release button
- 26 Remote Controller
- 27 Auxiliary rewind button
- 28 Drive button
- 29 Red-eye reduction flash button
- 30 Tripod socket
- 31 Battery chamber cover
- 32 Battery chamber cover lock

LCD PANEL

All indications will not actually appear simultaneously as shown.

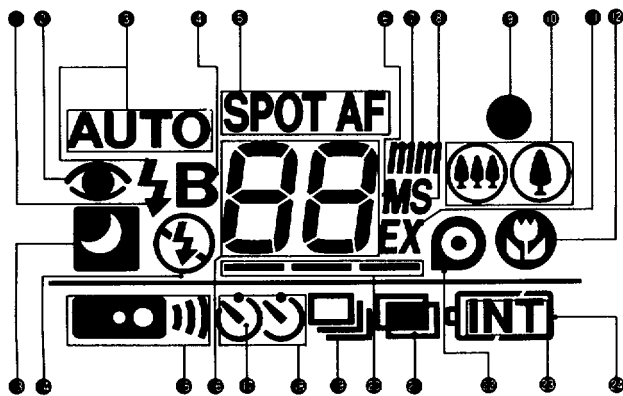

LCD (Liquid-crystal display)

- When the LCD is exposed to a high temperature of about 60°C, it may blacken, but when the temperature falls, it will return to normal.
- The LCD may also slow down in response to lower temperatures, but this is an LCD characteristic, not a defect.

- Flash-ON mode
- Red-eye Reduction Flash mode
- Flash Auto mode
- Bulb mode
- Spot AF mode
- Minute
- Millimeter (focal length)
- Second
- Shutter release button
- Zooming button
- EX (film counter)
- Macro mode
- Slow Shutter Speed
- Flash-OFF mode
- Remote Controller
- Exposure Counter/Focal Length Bulb-Timer/Interval-Timer
- Self-Timer
- Dual-Frame Self-Timer mode
- Consecutive Shooting mode
- Frame Advance
- Multi-Exposure Shooting mode
- Film Cartridge
- Interval Shooting mode
- Battery Exhaustion Warning



Asahi Optical Co., Ltd. P O 895 Tokyo 100-91 JAPAN
Pentax Europe n.v. Welvelaan 3-5, 1930 Zaventem BELGIUM
Pentax Handelsgesellschaft mbH. Julius-Vosseler-Strasse 104 2000 Hamburg 54 GERMANY
Pentax U.K. Limited. Pentax House, South Hill Avenue, South Harrow, Middlesex HA2 0LT U.K.
Pentax France Z.I. Argenteuil, 12 rue Ambroise Croizat, 95100 Argenteuil, FRANCE
Pentax Nederland Spinnveld 25, 4815 HR Breda, NETHERLANDS
Pentax (Schweiz) AG Industriestrasse 2, 8305 Dietlikon, SWITZERLAND
Pentax Scandinavia AB Fatlagsgädder 57, 75127 Uppsala, SWEDEN
Pentax Corporation 35 Inverness Drive East, Englewood, Colorado 80112 U.S.A.
Pentax Canada Inc. 3131 Unversal Drive, Mississauga, Ontario L4X 2E5, CANADA
Asahi Optical Brasileira Ind. e Com. Ltda. Rua Estados Unidos, 1053, Sao Paulo, BRASIL

Free Manuals Download Website

<http://myh66.com>

<http://usermanuals.us>

<http://www.somanuals.com>

<http://www.4manuals.cc>

<http://www.manual-lib.com>

<http://www.404manual.com>

<http://www.luxmanual.com>

<http://aubethermostatmanual.com>

Golf course search by state

<http://golfingnear.com>

Email search by domain

<http://emailbydomain.com>

Auto manuals search

<http://auto.somanuals.com>

TV manuals search

<http://tv.somanuals.com>