

PENTAX

VHS REMOVABLE VIDEO SYSTEM

SYSTEM VIDEO 2000A

(MODEL PV-R2000A PV-U2000A)

INSTRUCTION MANUAL

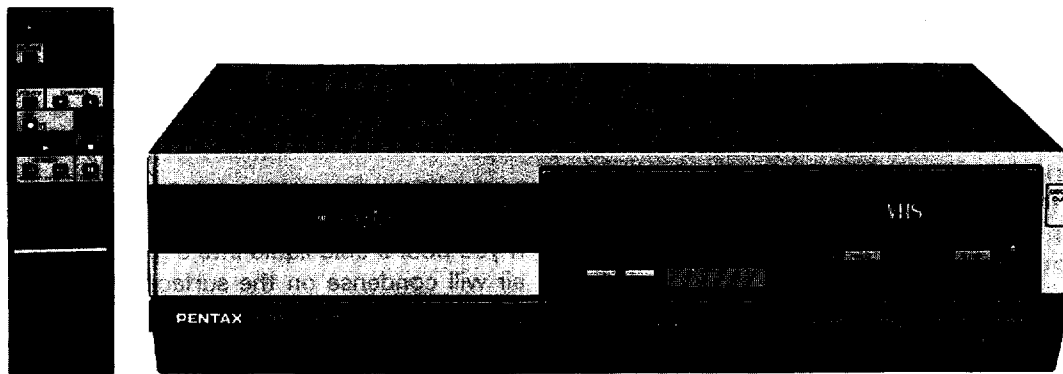

CONGRATULATIONS

You are now the proud owner of a Pentax VTR. Please read this instruction manual carefully before use and refer to it if any difficulties arise.

FEATURES

- Portable VTR is removable from the tuner main frame
- Programmable channel memory with voltage synthesized tuner
- Setting 4 programs/2 week is possible with built-in programmable timer
- Tuning ability for cable systems channel A-2, A-1 and A through W
- Infrared remote control operation
- Instant recording timer (IRT)
- Maximum 8 hours recording/playback
- Front loading mechanism
- Automatic rewind
- Soft touch control with microprocessor
- Visual search
- Rewind shut-off

CONTENTS

FOR YOUR SAFETY	2
REMOVING AND MOUNTING PORTABLE VTR ..	3
CONTROLS AND FEATURES	4
VIDEO CHANNEL SETTING	7
INSTALLATION	8
CHANNEL TUNING	10
CLOCK TIME SETTING	12
NORMAL TV VIEWING	12
CASSETTE TAPES	13
RECORDING TV PROGRAMS	13
INSTANT RECORDING.....	14
PLAYBACK.....	15
AUDIO DUBBING	16
VIDEO DUBBING.....	17
TIMER RECORDING	18
POWER SUPPLY (For Portable VTR).....	20
HOW TO CHARGE BATTERY PACK	21
RECORDING FROM A VIDEO CAMERA	22
REMOTE OPERATION.....	23
HEAD CLEANING	24
PERIODIC MAINTENANCE.....	24
PROBLEM GUIDE.....	24
SPECIFICATIONS	25

FOR YOUR SAFETY

Power supply: AC 120V, 60 Hz only

The POWER switch located on the front panel of the VTR switches the VTR to on and off, leaving the clock/timer facility unaffected.

If the unit is to be left unattended for a long period and it is not intended to use the timer recording function, it is recommended that the unit be completely switched off and the plug removed. If you intend to record during your absence, remember there is no necessity for the TV receiver to be switched on.

Illustrated below is the label on the back of your unit.



The lightning flash with arrowhead symbol, within an equilateral triangle, is intended to alert the user to the presence of uninsulated "dangerous voltage" within the product's enclosure that may be of sufficient magnitude to constitute a risk of electric shock to persons.

The exclamation point within an equilateral triangle is intended to alert the user of the presence of important operating and maintenance (servicing) instructions in the literature accompanying the appliance.

**CAUTION: TO REDUCE THE RISK OF ELECTRIC SHOCK,
DO NOT REMOVE COVER (OR BACK).
NO USER-SERVICEABLE PARTS INSIDE.
REFER SERVICING TO QUALIFIED SERVICE PERSONNEL.**

WARNING:

Many television programs are copyrighted. One court has held that private, non-commercial, in-home video taping of copyrighted televised programs constitutes copyright infringement. Purchasers are advised not to copy such programs.

WARNING: TO PREVENT FIRE OR ELECTRIC SHOCK, DO NOT EXPOSE THIS APPLIANCE TO RAIN OR MOISTURE.

Moisture condensation

If you pour a cold liquid into a glass, water vapor in the air will condense on the surface of the glass. This is moisture condensation.

Moisture condensation on the head drum, one of the most crucial parts of the Deck, will cause damage to the tape. The Deck has a humidity detector unit built in. When the Deck is exposed to a rapid temperature change from cold to warm, some condensation will occur. When moisture is present, stop indicator light will flash. While this light is on, the VTR will not operate. Under these circumstances allow at least 2 hours for the Deck to dry out. When light stops blinking, the VTR can be operated.

REMOVING AND MOUNTING PORTABLE VTR

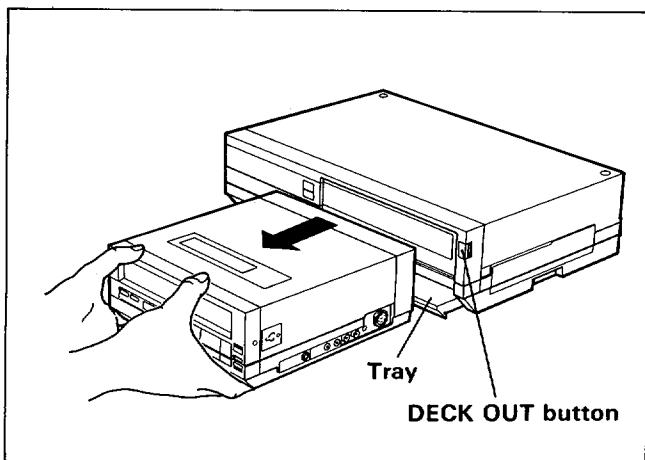

- Press the DECK OUT button. The portable VTR is ejected a little toward the front. Take out the VTR.
- If the tray obstructs you after the portable VTR is taken out, push it in until a click is heard.

Cautions:

Be sure to place the tuner main frame horizontally when ejecting the portable VTR. Do not tilt the tuner main frame with the portable VTR ejected as the portable VTR drops out.

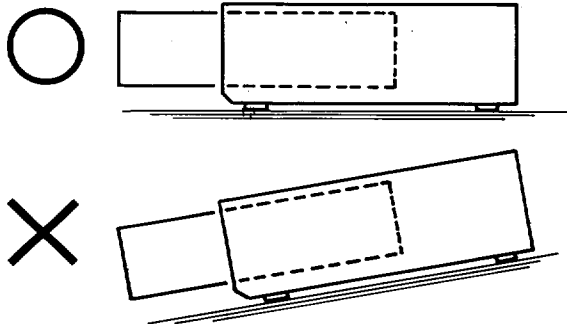

- Mounting the Portable VTR

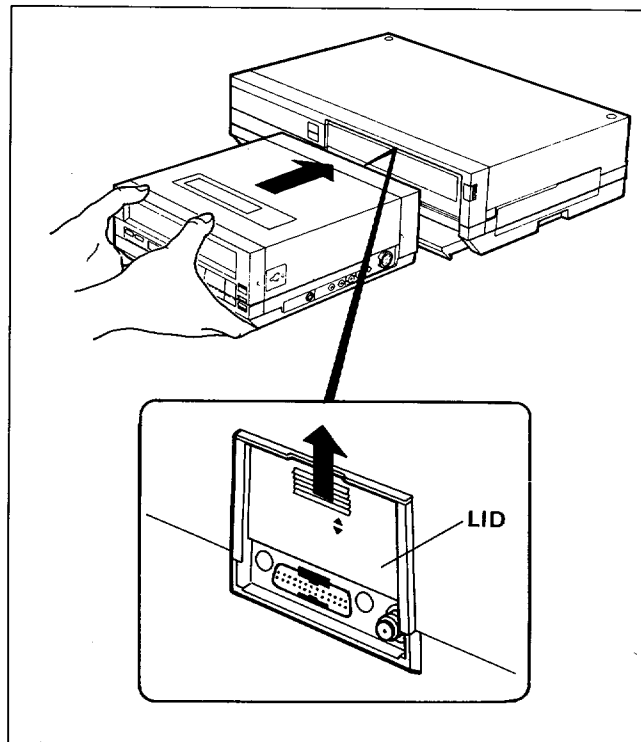

- Confirm that the lid on the rear of the portable VTR opens and push the portable VTR straight into the tuner main frame firmly until a click is heard.
- Press the DECK OUT button to pop out the tray, mount the portable VTR on the tray, then push it into the tuner main frame. You can easily mount the portable VTR.

■ USING THE SHOULDER BELT

To Install the Shoulder Belt

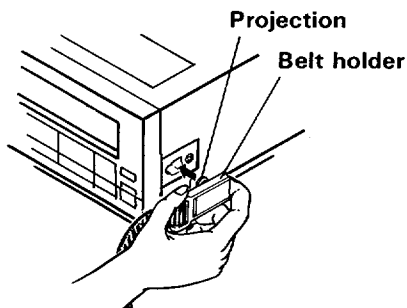

Attach each projection of the belt holders to the mounting holes on the sides of portable VTR and pull it forward until the projections are locked.

To Remove the Shoulder Belt

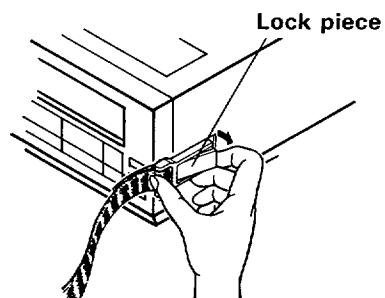

Slide the belt holder backward while raising the lock piece.

CONTROLS AND FEATURES

FRONT VIEW

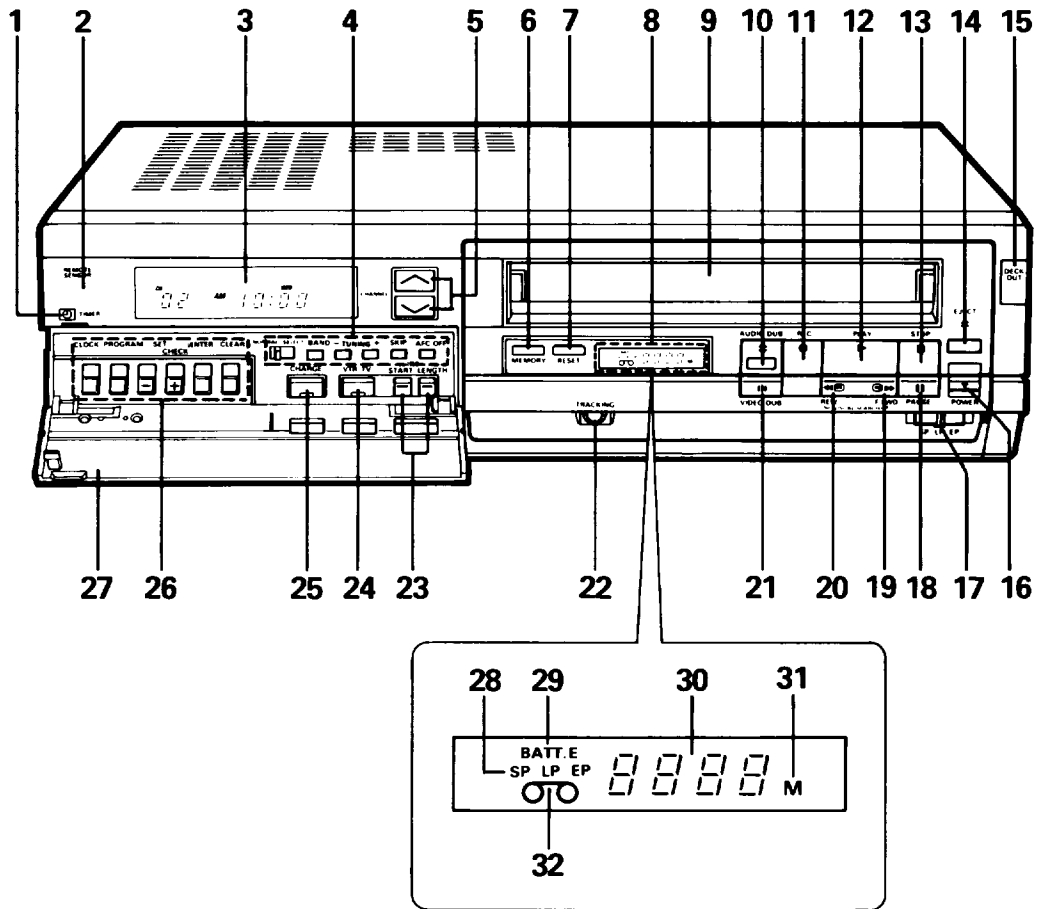

REAR VIEW

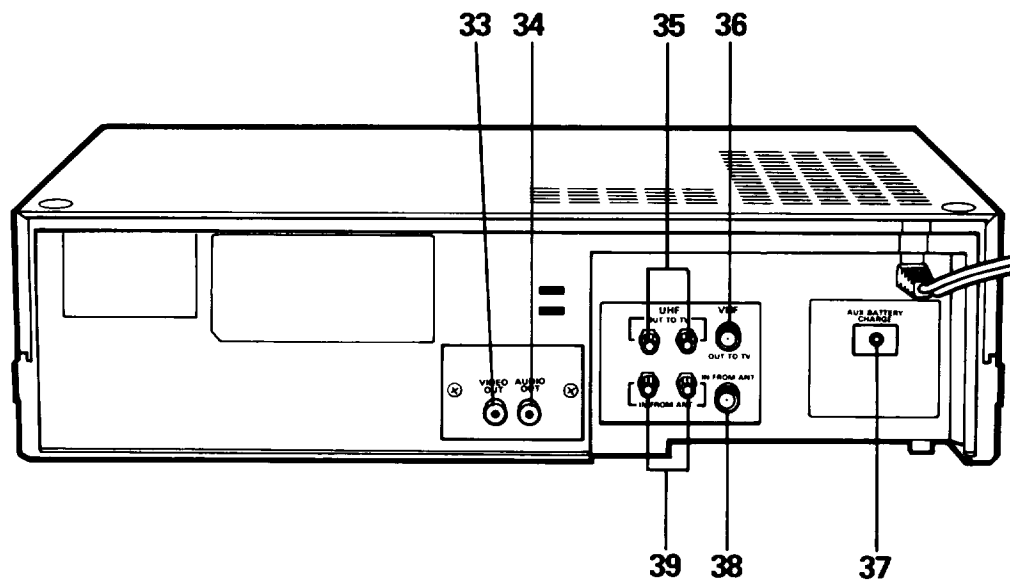

- 1. TIMER INDICATOR**
Will light when turning power off after programming.
- 2. INFRARED RAY RECEIVING SECTION**
Receives the infrared ray from remote control unit.
- 3. ELECTRONIC DIGITAL DISPLAY**
This display is used as an indicator for the present time of day, channel number, timer programming and instant recording.
- 4. CHANNEL PROGRAMMING CONTROLS**
Program channels for channel up and down selection with these controls.
- 5. CHANNEL SELECT BUTTONS**
Select the channels you wish to view or to record by pressing these buttons.
- 6. MEMORY COUNTER BUTTON**
When pushed in MEMORY will stop at "0000".
- 7. COUNTER RESET BUTTON**
To reset counter to "0000".
- 8. CENTRALIZED CONTROL DISPLAY**
- 9. CASSETTE COMPARTMENT**
- 10. AUDIO DUB BUTTON**
Press "PLAY" and "AUDIO DUB" buttons simultaneously to audio dub.
- 11. RECORD BUTTON**
Press RECORD button and while holding RECORD, press PLAY button to record.
- 12. PLAY BUTTON**
Press to start play.
- 13. STOP BUTTON**
Press to stop tape. The STOP button must be pressed between "RECORD" and any other operation.
- 14. EJECT BUTTON**
With power on, press to remove cassette.
- 15. DECK OUT BUTTON**
Press to remove the portable VTR from the tuner main frame.
- 16. POWER SWITCH**
Turn system power on and off.
- 17. SPEED SELECT SWITCH**
Recording time using Cassette tape T-160:
EP: 8 hours
LP: 5.3 hours
SP: 2.6 hours
Note: Playback speed automatically corresponds with recorded speed.
- 18. PAUSE BUTTON**
Press to pause during recording or playback.
- 19. FAST FORWARD/VISUAL SEARCH BUTTON**
Press to activate fast forward.
Press this button during playback of a recorded tape, and forward playback picture at high speed can be seen.
- 20. REWIND/VISUAL SEARCH BUTTON**
Press to start rewind.
Press this button during playback of a recorded tape, and reverse playback picture at high speed can be seen.
- 21. VIDEO DUB BUTTON**
This button is used when recording the desired scene or title on the recorded tape. Refer to page 17 for details.
- 22. TRACKING CONTROL KNOB**
To minimize noise in playback.
- 23. INSTANT RECORDING TIMER BUTTONS (IRT)**
IRT allows unattended recording without programming the timer. See page 14 for details.
- 24. VTR/TV SELECT SWITCH**
Selects the signal to be viewed.
The VTR indicator comes on when the unit is in VTR mode and the signal received by the VTR is displayed on the TV screen. With the switch in the TV position (indicator light off) the broadcast signal is received directly by your TV set. When the VTR power is turned off, the VTR automatically switches to "TV".
- 25. CHARGE BUTTON**
Press for battery charging.
- 26. TIMER CONTROLS**
- 27. DOOR FOR SECONDARY CONTROLS**
- 28. TAPE SPEED INDICATORS**
- 29. BATTERY INDICATOR**
- 30. COUNTER DISPLAY**
Indicates relative position of programs on tape. It may be used to help to locate a programs starting point.
- 31. MEMORY INDICATOR**
Memory indicator comes on when MEMORY COUNTER button is turned on.
- 32. TAPE-IN INDICATOR**
Comes on when cassette is located in the compartment.
- 33. VIDEO OUT**
For connection to monitor TV or another VTR.
- 34. AUDIO OUT**
For a connection to a monitor, your stereo system or another VTR.
- 35. UHF ANTENNA OUTPUT**
Connect these terminals to the UHF antenna terminals on the back of the TV.
- 36. VHF ANTENNA OUTPUT**
Connect this terminal to the VHF antenna terminal on the back of the TV.
- 37. AUXILIARY BATTERY CHARGE TERMINAL**
A second rechargeable battery PV-BT01A connected with battery connector PV-BA01A can be plugged in here to charge.
Note: The second battery must be disconnected before the internal battery will be charged.
- 38. VHF ANTENNA INPUT**
Connect the VHF antenna to this terminal.
- 39. UHF ANTENNA INPUT**
Connect the UHF antenna to these terminals.

CONTROLS AND FEATURES

PORTABLE VTR

SIDE VIEW

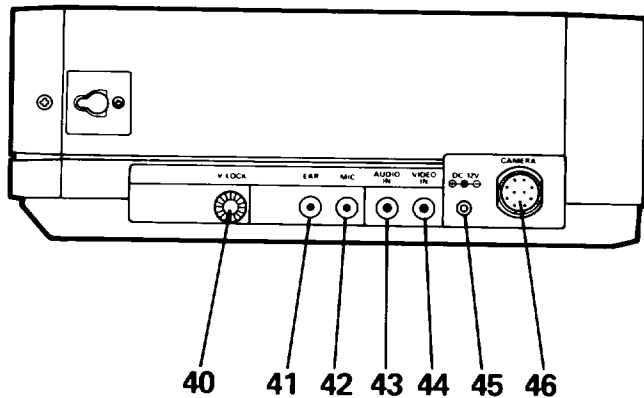

40. V. LOCK CONTROL

If you see vertical shaking on the TV screen in the still playback mode, rotate the V. LOCK control to minimize shaking.

41. EARPHONE JACK

For microphone.

42. MICROPHONE JACK

43. AUDIO IN

Receives audio signals from external sound equipment or another VTR.

44. VIDEO IN

Receives video signal from another VTR.

45. EXTERNAL BATTERY JACK

Optional DC car cord plugs in here to connect VTR to car cigarette lighter socket or to a spare rechargeable battery.

46. CAMERA JACK

Camera is connected here.
Automatically overrides any other input video signal.

REAR VIEW

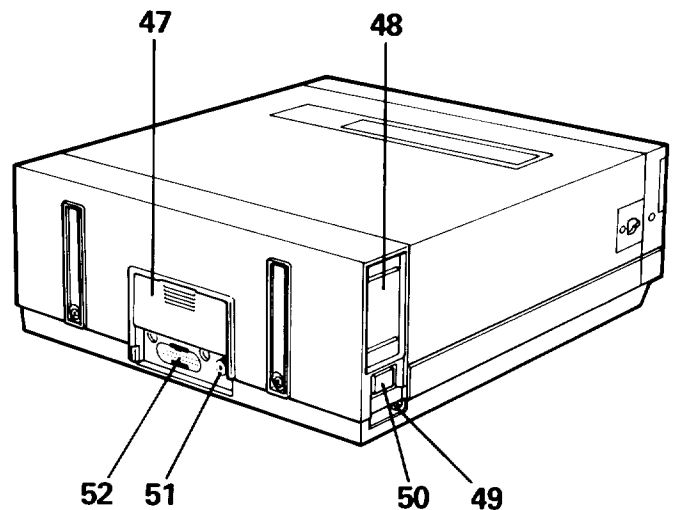

47. LID

48. BATTERY COMPARTMENT

Door opens when the battery is inserted.

49. RF CONVERTER SWITCH

Set this switch to whichever channel (CH3 or CH4) is unused in your area.

50. BATTERY EJECT BUTTON

Press to remove the battery.

51. RF OUT

When the portable VTR is removed from the tuner main frame, the coaxial cable connects VTR and TV for playback.

52. TUNER/TIMER CONNECTING TERMINAL

This allows you to connect VTR to your tuner main frame with ease.

VIDEO CHANNEL SETTING

The RF converter changes the video and audio signals from the built-in tuner or tape playback to a standard television broadcast signal on channel 3 or 4. To obtain video recorder output on either channel 3 or 4, set the RF converter switch to whichever channel is unused in your area as follows:

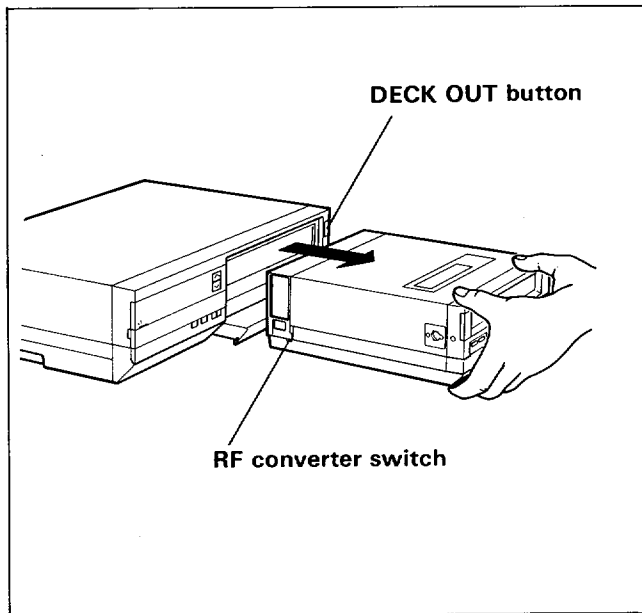

1. Press the DECK OUT button and remove the portable VTR.
 - Be sure to place the unit horizontally when removing the VTR. (See page 3 for details.)
2. Slide the RF converter switch to CH3 or CH4 to match the channel selector of your TV. This is the video channel of your TV. Your TV must be tuned to this channel whenever a video cassette is played back by the VTR.
3. Push in the portable VTR into the tuner main frame. Note: Push the portable VTR firmly in as far as possible.

INSTALLATION

ANTENNA CONNECTION

There are 2 types of TV broadcasts, VHF and UHF. There are areas where ① only VHF TV broadcasts can be received, ② only UHF TV broadcast can be received and ③ both VHF and UHF TV broadcasts can be received.

There are various types of antenna hook-ups. Use the correct one, referring to the following diagrams. At first, in order to connect your VTR to your TV for recording and playback, it will be necessary to attach the antenna to your VTR. Then you must connect your VTR to your Television. Your VTR comes with the necessary connectors and adapters for most types of VTR installation.

If your television is used on a cable system, special installation procedures may be required. We suggest you contact your dealer or cable company for assistance. Installation is not covered by the Limited Warranty.

“Note to CATV system installer: This reminder is provided to call the CATV system installer’s attention to Article 820 – 22 of the NEC that provides guide lines for proper grounding and, in particular, specifies that the cable ground shall be connected to the grounding system of the building, as close to the point of cable entry as practical”.

If you want to attach your VTR to a Portable TV with “rabbit ears” (dipole antenna), you must disconnect the “rabbit ear” leads from the antenna input terminal of the TV. It will be necessary to extend these leads so they can be attached to your VTR. We recommend an outside antenna.

Precaution

- Avoid extreme heat, cold, moisture and dust.
- Avoid use near magnetic field and places subject to strong vibrations.
- Do not insert wires, etc. through the cassette compartment.
- Do not move the unit from a hot place to a cold place or vice versa.
- Be careful; when the surface of the case is wiped with a volatile agent such as benzine, alcohol, thinner, etc., or a chemically processed cloth, the surface finish may deteriorate or its coating may peel.
- Allow for air circulation at bottom, top and back of unit.

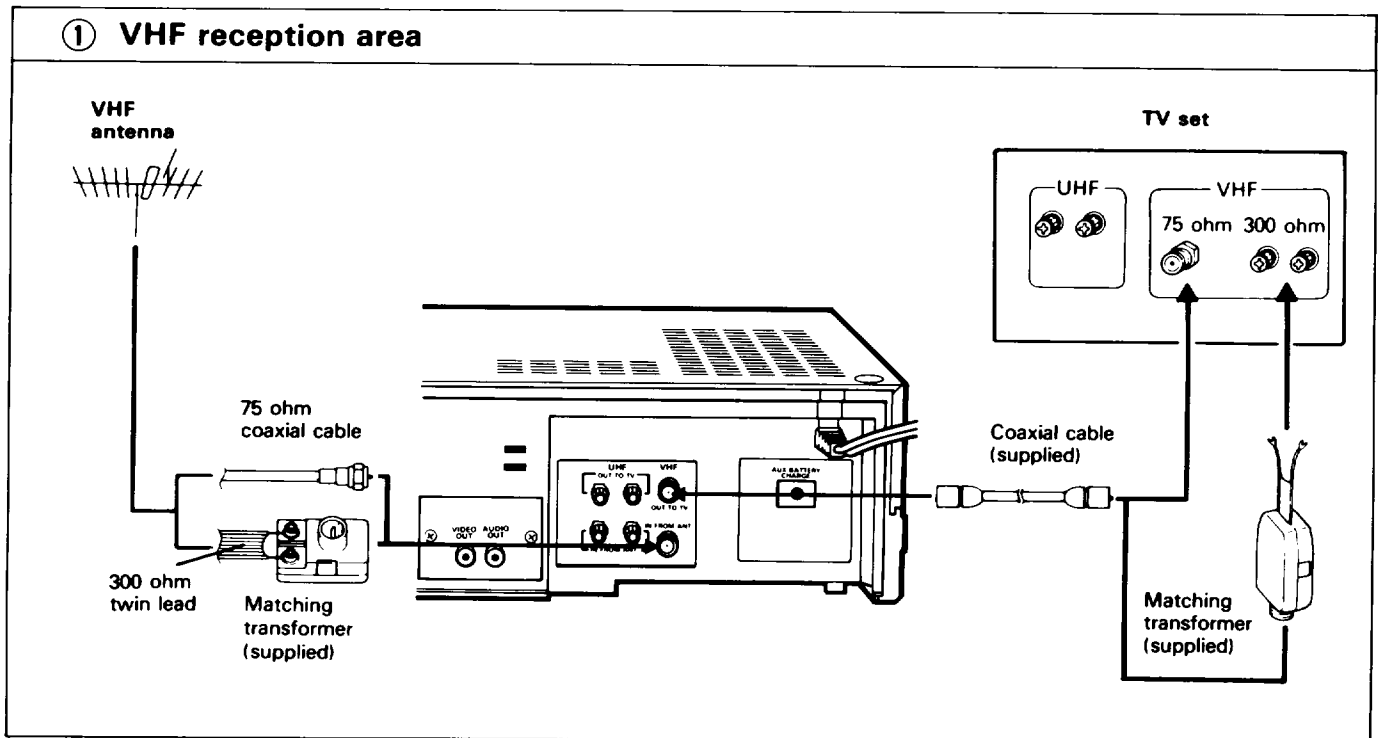

② UHF reception area

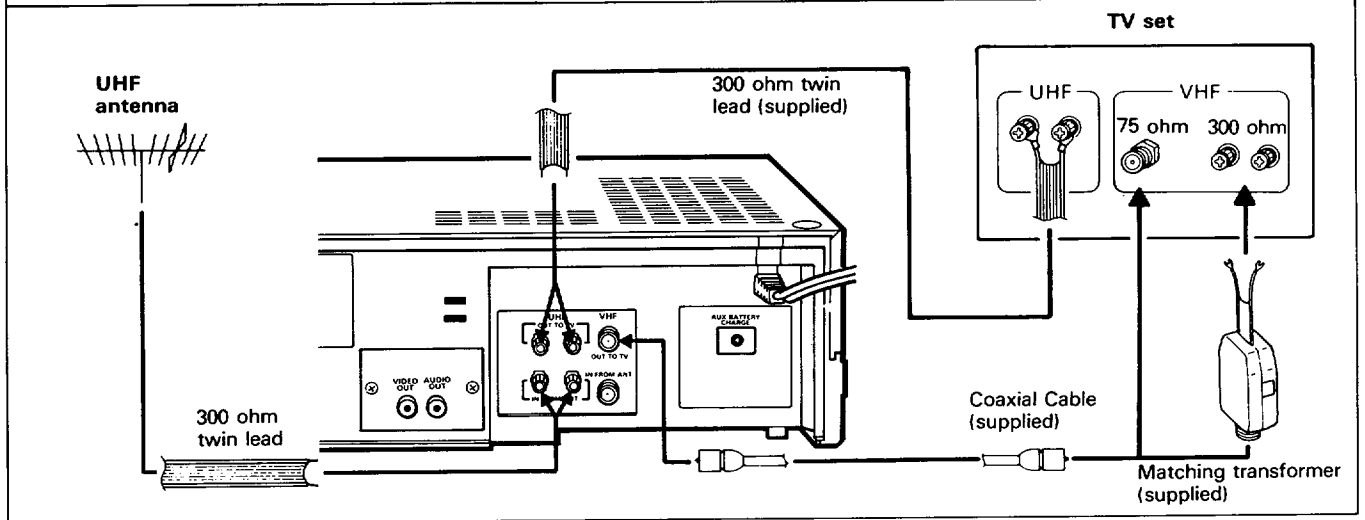

③ Both VHF and UHF reception area

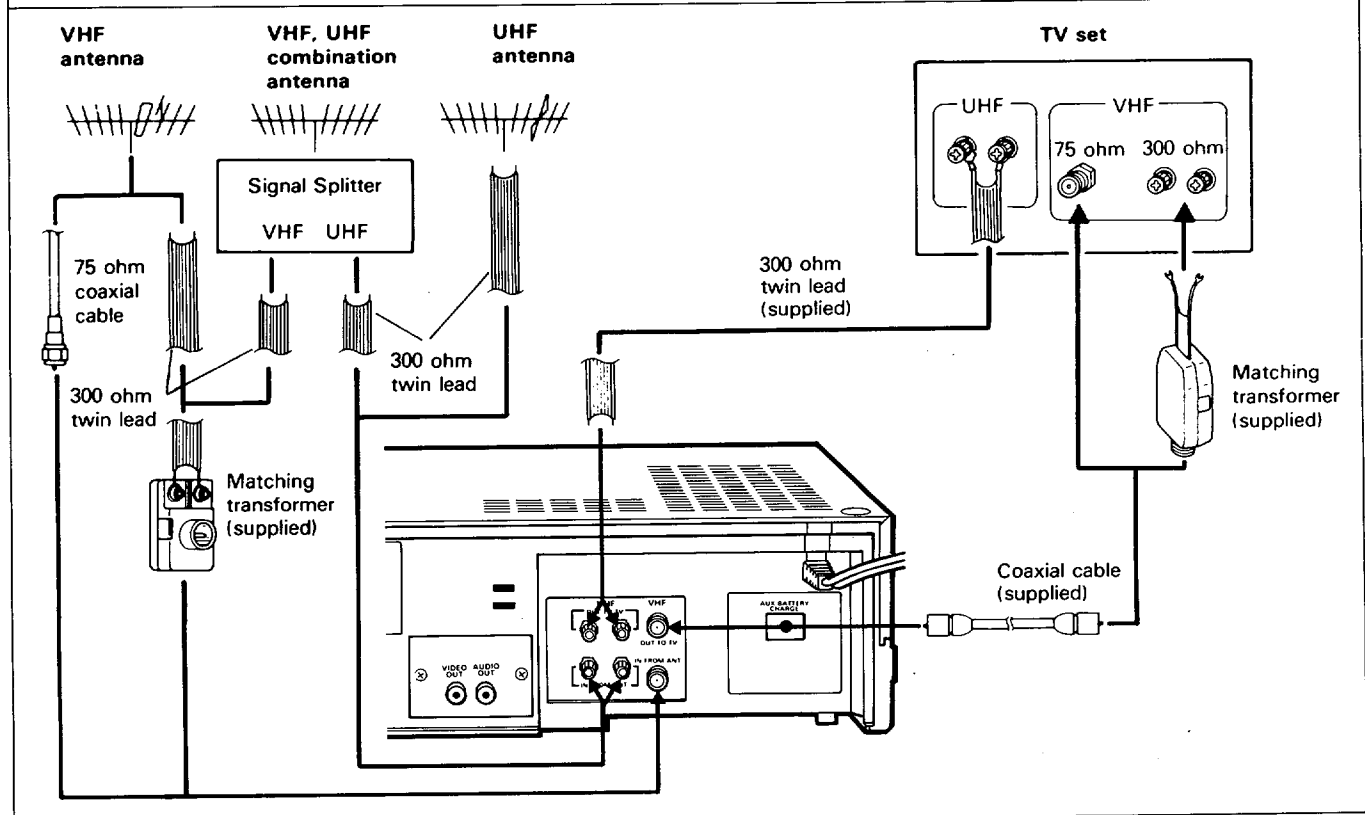

Cable system connection

Basic method

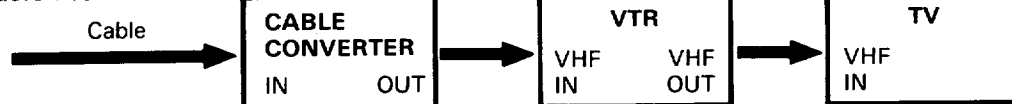

Note: With this connection you can only watch and record the same program. The cable converter must be turned on for recording. Other connections are possible but may require additional antenna accessories which are not supplied. Cable ready VTR models can be used with this connection, but for maximum flexibility of use, additional accessories are required.

CHANNEL TUNING

Your VTR can be preset for up to 80 memorized channels. It has been preset to receive VHF channels 2 through 13 when shipped. The channel number in the display will originally match the actual TV channel selected. During the procedure which follows, you can reprogram any display channel number, so that it selects any actual TV channel. This means that after programming of the memorized channels, the display can indicate a different number than the actual TV channel tuned by that channel memory position.

You can set any channel memory position to receive any station. This ability is most useful when the tuner is used in CATV installations. To add UHF or CATV channels not factory preset, or to preset the VHF channels in some other order, use the procedure which follows.

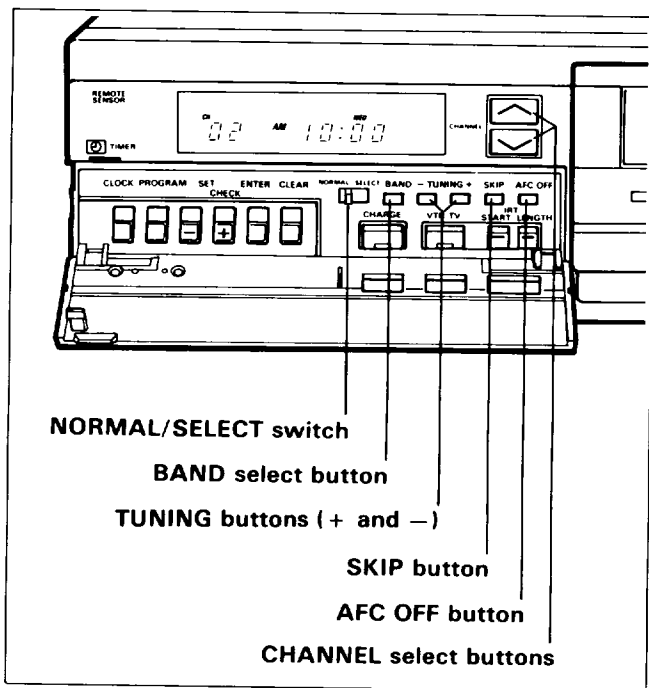

1. Turn on the TV and VTR.
2. Set the TV to Channel 3 (or 4). (for your video channel)
3. Set the RF converter switch of VTR to channel 3 (or 4).
4. Open the door for secondary controls.
5. Set the NORMAL/SELECT switch to "SELECT". Time indication will change to band indication.

Note: When the NORMAL/SELECT switch is set to "SELECT", the VTR/TV select switch is switched to the VTR mode automatically.

6. Select the channel number to be memorized by pressing the CHANNEL select buttons.

Note:

1. Your VTR can use the following numbers as TV channel presets: 00, 01 through 72, 91, 92, 95 through 99.
2. Your VTR has been preset to receive VHF channels 2 through 13.

3. You should determine which channel memory positions have not been preset before entering programming information.

New information automatically erases previous programmed data.

7. Press the BAND select button to select either "L", "H" or "U" according to the channel number as listed below.

Indication on display	Channels to be received
L	VHF low channels 2~6
H	CATV channels A-2, A-1 and A~I VHF high channels 7~13 CATV channels J~W
U	UHF channels 14~83

For example, if you're going to tune one of UHF channels 14 through 83, display the letter "U" by pressing the BAND select button.

8. Press and hold the TUNING button (+) until the picture for the channel number you are programming appears on the TV screen. (For fine tuning tap on the (+) and (-) TUNING buttons alternately.) The active channel with lowest frequency in the band will first appear, followed in sequence by the other active channels, as in the "Channel frequency spectrum" on next page.

Note:

1. Holding down the TUNING button (+) at the end of band will result in tuning into the next band. The band display will change to the next higher band.
2. If you press the TUNING button (-) at first, the band will change to adjacent band immediately. The active channel with the highest frequency in the band will first appear, followed in opposite sequence by the other active channels.
3. Speeds of picture scanning from the lowest channel to the highest in each band are as follows;

Band	Speeds
L	About 20 seconds
H	About 40 seconds
U	About 80 seconds

9. After releasing the TUNING button when the channel picture appears for the channel number you are programming, press the up (+) and down (-) TUNING buttons to fine tune the TV channel.
10. Repeat steps 6 through 9 for other channels.
11. Return the NORMAL/SELECT switch to "NORMAL".

- To check programming, press the CHANNEL select buttons to cycle the VTR tuner through all the channels you have programmed. If a channel was missed or requires fine tuning, repeat above steps for the channel involved.

Always return the NORMAL/SELECT switch to "NORMAL" after preprogramming is complete.

Channel frequency spectrum

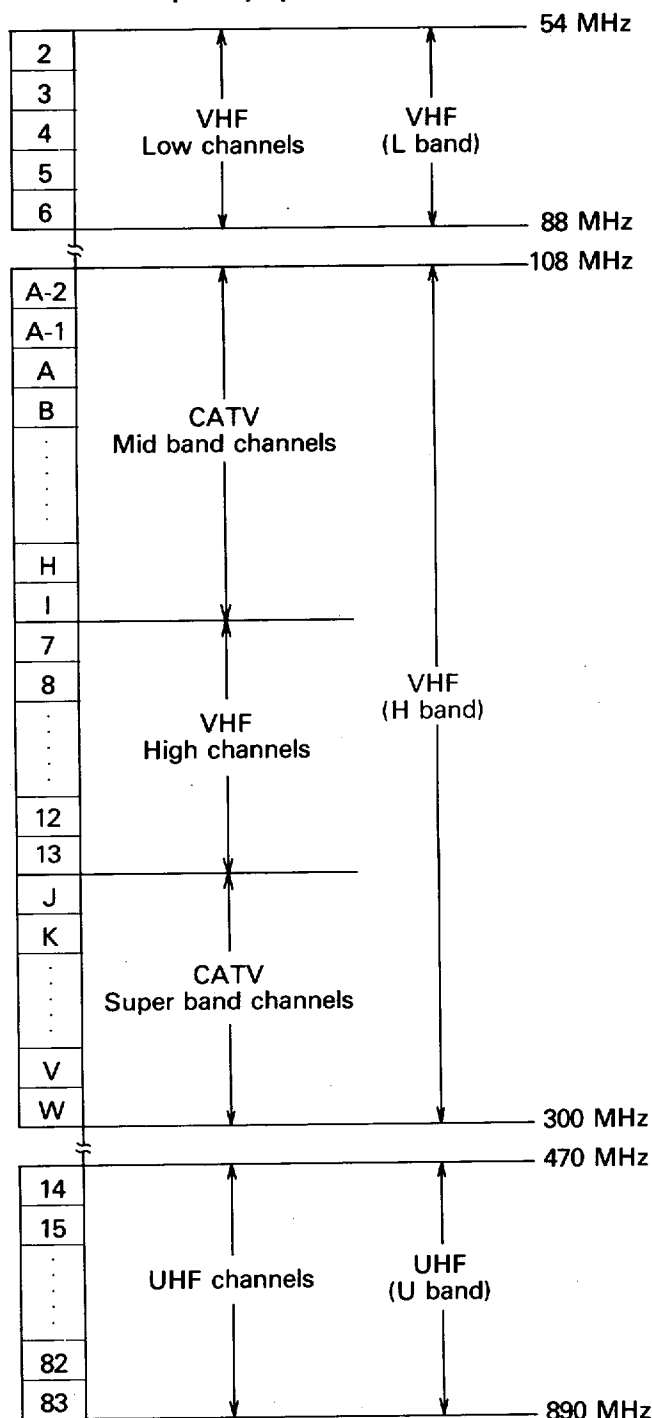

AFC (Automatic Frequency Control)

A channel is fine tuned using up (+) and down (-) TUNING buttons. When the NORMAL/SELECT switch is returned to "NORMAL", AFC is turned on and the channel "locks in". The AFC electronically optimizes the fine tuning adjustment.

If a TV channel signal is marginal due to graininess or ghosting, the picture may sometimes be improved by manually tuning for best picture and then defeating the AFC action. To turn AFC off, follow the procedure below.

AFC off tuning procedure

- Make sure that NORMAL/SELECT switch is set to "NORMAL".
- Select the desired channel on which to disable AFC by pressing CHANNEL select button.
- Set the NORMAL/SELECT switch to "SELECT".
- Press the AFC OFF button.
- Return the NORMAL/SELECT switch to "NORMAL".

Note:

- The AFC is only switched off for the channel you have been programming. AFC remains in effect on all other channels. To defeat the AFC for additional channels, repeat the above steps.
- Pressing the AFC OFF button once again will turn the AFC on.

Eliminating unwanted preset channels

You can rearrange the desired channels by eliminating unwanted preset channels for channel up/down selection.

- Set the NORMAL/SELECT switch to "SELECT".
 - Press the CHANNEL select buttons until an unwanted channel is tuned.
 - Press SKIP button once.
Sound will go off indicating the channel has been erased from memory.
 - Repeat steps 1 through 3 until all unwanted channels have been eliminated.
 - Return the NORMAL/SELECT switch to "NORMAL".
- Channels which have been eliminated cannot be selected by the CHANNEL select buttons.

Note: To restore the erased channel, repeat the above steps 1 through 3.

CLOCK TIME SETTING

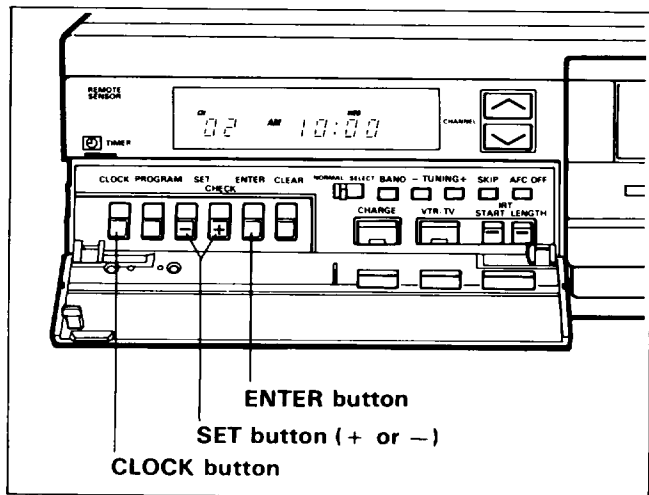

- When VTR is plugged into an AC outlet for first time, the clock display shows "--:--".

The clock is set using the CLOCK, SET and ENTER buttons. The CLOCK button selects the clock setting mode. The SET buttons advance the Day, Hours or Minutes. The ENTER button stores the Day, Hours or Minutes. After the Day is entered with ENTER, the next press of the ENTER button will enter the hours, and next press will enter the minutes. To indicate the "DAY" mode, the day will flash. To indicate the "HOUR" mode, the hours digits will flash. To indicate the "MINUTE" mode, the minutes digits will flash. When the ENTER button is pressed, the flashing digits will be stored in memory.

1. Turn on power of VTR.
2. Press and hold the CLOCK button while performing steps 3 through 5.

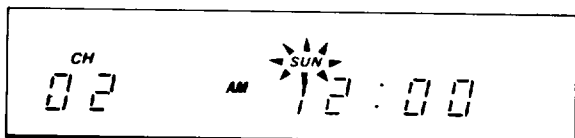

3. Press the SET button (+ or -) repeatedly to select the present day of the week. Hold the button down to advance rapidly. When the present day of the week appears, press the ENTER button.

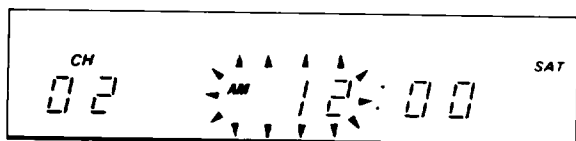

For example, the diagram shows that Saturday (SAT) has been set.

4. Press the SET button (+ or -) to set the present hour. Hold the button down to advance rapidly. Press the ENTER button when the present hour appears.

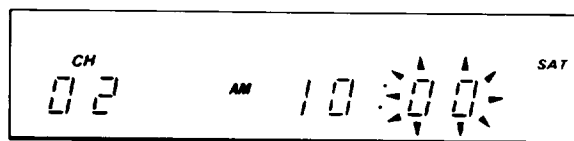

For example, the diagram shows that "AM 10" hour has been set.

5. Press the SET button (+ or -) to set the minute. Hold the button down to advance rapidly. Press the ENTER button when the present minute appears.

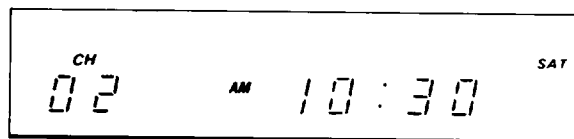

For example, the diagram shows that "30" minutes has been set.

6. Release the CLOCK button.

Now the clock has been set to the correct time of day.

For zero second setting, set the minutes to one minute ahead of present time and release the CLOCK button when the next minute exactly starts.

Note: • If your clock display shows "--:--", your home had a power failure. The time should be reset.

- 12:00 AM is midnight; 12:00 PM is noon.

NORMAL TV VIEWING

You do not need to disconnect VTR from your TV set to watch TV. When you turn off the POWER switch on your VTR, the VTR automatically switches to "TV".

To watch TV, turn on TV and select a channel as usual.

CASSETTE TAPES

Insertion and removal of cassettes

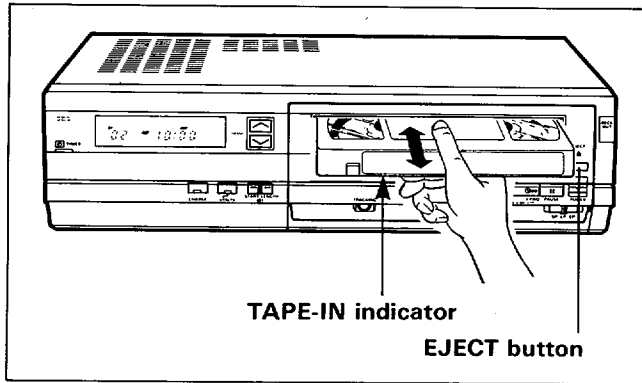

Before inserting or removing cassette, be sure to turn the **POWER** switch on.

Note: TAPE-IN indicator lights when cassette is inserted in the compartment.

Insertion

1. Insert the cassette.

Removal

1. Press EJECT button.
2. Remove the cassette.

Types of video cassette

Use video cassettes with the **VHS** mark in this VTR. The table below shows how to distinguish difference in recording time of cassettes.

TYPES	RECORDING TIME		
	SP	LP	EP
T-30	30 min.	60 min.	90 min.
T-60	60 min.	120 min.	180 min.
T-120	120 min.	240 min.	360 min.
T-160	160 min.	320 min.	480 min.

It is recommended that the **SPEED** select switch of the VTR is set to "SP" to obtain better picture and sound quality when recording a music program.

To avoid erasing a recording

Break off the safety tab using a screwdriver or similar tool.

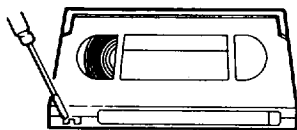

To re-record on a cassette which has its safety tab removed

Cover the hole with cellophane tape.

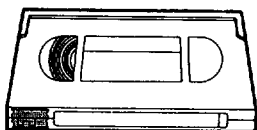

Refer to the instructions included with cassettes for more information.

RECORDING TV PROGRAMS

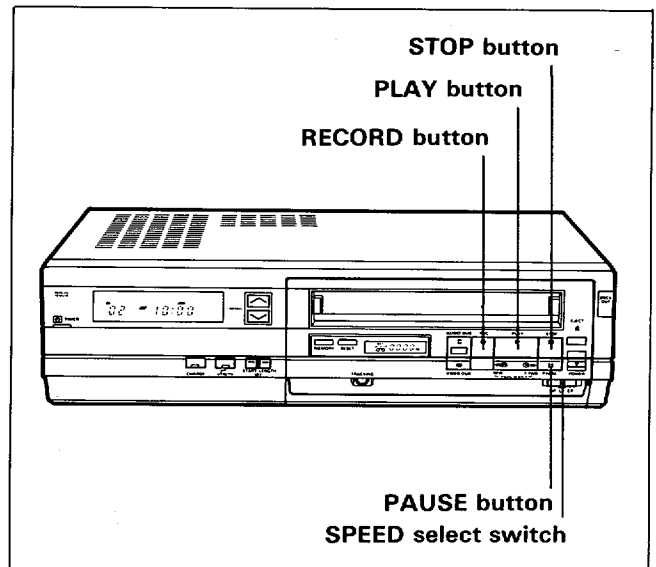

If you wish to view a program being recorded, turn on TV and select the channel 3 or 4 for your video channel.

1. Turn on VTR power.

Note: When the power is turned on, VTR/TV select switch is switched to the VTR mode automatically.

2. Insert Cassette.

Be sure to check that the record safety tab is not missing.

3. Set **SPEED** select switch to "SP", "LP" or "EP".

It is recommended to set this switch to "SP" when recording a music program.

4. Select channel to be recorded.

5. Press **RECORD** button and while holding **RECORD**, press **PLAY** button.

6. Press **PAUSE** button to stop recording temporarily.

Press again to release.

Note: To prevent tape damage, do not leave the unit in the pause mode for more than 5 minutes.

7. Press **STOP** button to stop recording.

To record one program while viewing another

You can record one program while viewing another by merely selecting the channel with your TV channel button after setting the VTR/TV select switch to "TV". The recorded program can be viewed later at your convenience.

To change the channel to be recorded while in record mode

During recording, the channel lock function operates and channel cannot be changed if the **CHANNEL** select button is pressed.

If you wish to change channel during recording, proceed as follows.

1. Press the **PAUSE** button.

2. Change channel desired.

3. Press the **PAUSE** button to release record pause mode.

INSTANT RECORDING

Instant recording timer (IRT) allows you to start an unattended recording without programming the timer. It is convenient if you are interrupted while viewing a program and want to record the balance of it. By using the delayed start feature you can delay the recording start up to 24 hours. Although you do not need to program the timer for IRT, the clock must be set.

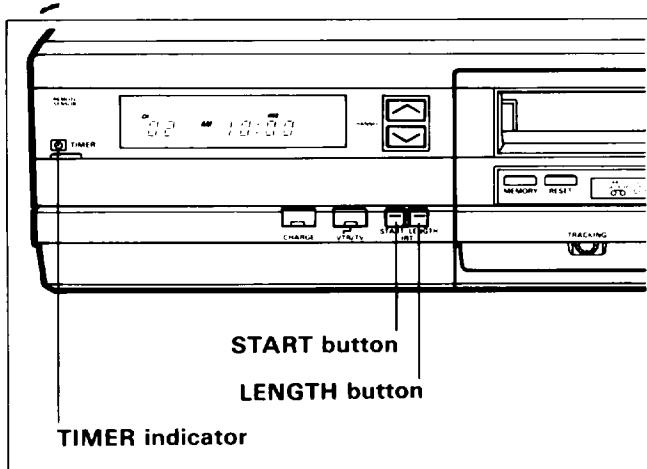

IRT with immediate start

1. Follow the steps 1 through 4 on "RECORDING TV PROGRAM".
2. Press the LENGTH button to select the recording time. Pressing the button once sets the timer to "0:00". The recording time changes in hour and minute in the order of 0:30, 1:00, 1:30, 2:00, 3:00 and 4:00 every time the button is pressed. The TIMER indicator will come on, and IRT will begin when 0:30 is displayed. During recording, the remaining IRT time appears on the timer display.
3. At the end of recording the display reads 0:00; the VTR will automatically shut off.

Note: The IRT feature does not operate during play and after a program timer recording has started as programmed. During rewind mode, the IRT recording will automatically start after the tape is rewound fully to the end.

Delayed start IRT

You can delay the start of an IRT by using the START button.

1. Follow the steps 1 through 4 on "RECORDING TV PROGRAM".
2. Press the START button to set the start time. The start time may be set to begin on any hour or half hour, up to 24 hours from present. For example, the present time is 9:15 PM and you want to record a program that starts at 10:30 PM. Just press the START button three times.
3. Press the LENGTH button repeatedly to select the desired recording time. The recording time changes in hour and minute in the order of 0:30, 1:00, 1:30, 2:00, 3:00 and 4:00 every time the button is pressed.

4. Turn off the VTR power.

The TIMER indicator will come on. The recording will start at the time you have selected and will automatically stop with the display reading "0:00", which will then be reset to the present time of the day.

Note:

1. To stop the VTR during IRT, press LENGTH button until the timer display reads "0:00" or press POWER button once and STOP button within ten seconds.
2. To change the IRT program, the previous information must be first cleared. (See below)
3. If IRT and the program timer recording overlap, the former will override the latter.
4. The recording time can be extended any time during IRT by pressing LENGTH button. The timer display will be reset to 0:30, 1:00, 1:30, 2:00, 3:00 or 4:00 as selected.

Recalling the IRT program

Press START and LENGTH buttons respectively for recalling the starting time and the recording time. In about 8 seconds the displays return to the present time of the day.

Notes:

1. To recall the recording time, press LENGTH button only once. Pressing more will change the recording time and cause a need for resetting.
2. POWER button may be on or off.

To clear IRT program

Press LENGTH button as many as may be required to indicate "0:00" on the display. After approximately 8 seconds the display will show the present time of day, and IRT has been now cleared.

Note: POWER button may be on or off.

PLAYBACK

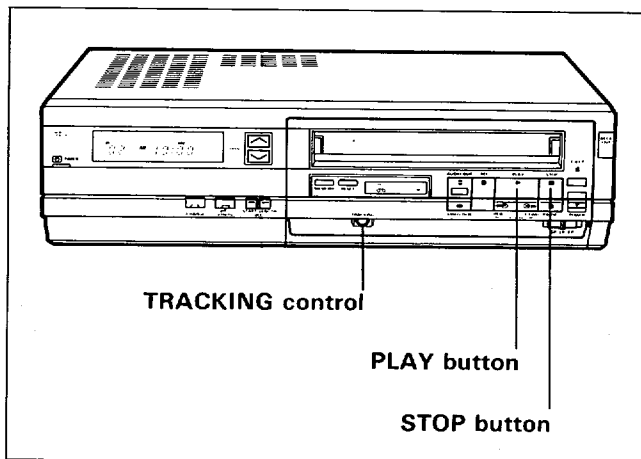

1. Turn on VTR.
2. Turn on TV and select the video channel.
3. Insert the cassette.
4. Press the PLAY button.
5. Press the STOP button to stop playback.

Tracking control adjustment

When playing prerecorded tapes or those recorded on units other than you own, black and white streaks may appear on your TV screen. If this occurs, turn the TRACKING control slowly in either direction until the streaks disappear. When playback of this particular tape is over, readjust the TRACKING control to its original position. The original position is normally in the center position.

Still playback

Press the PAUSE button to stop the picture on the screen during playback.

During still playback, press the PAUSE button to return to normal playback, or the STOP button to stop the tape.

Note:

- If you see vertical shaking on the TV screen in the still playback mode, rotate the V. LOCK control on the side of the VTR to minimize shaking.
- When the still playback mode continues for about 5 minutes, the VTR switches to the stop mode automatically to prevent damage to the tape.
- The playback picture will have some noise in the still playback mode.

Visual search

This allows you to view the picture from a recorded tape at high speed in both the forward and reverse directions.

Press the PLAY button to play a tape, then press and hold either the VISUAL SEARCH button F.FWD or REW. Pictures can be viewed at high speed in either the forward or reverse direction.

Note: The playback picture will have some noise in the visual search mode.

Automatic rewind

The tape will stop and automatically rewind when the end of the tape is reached.

This function does not operate during Timer recording and Instant recording.

Rewind shut off

If power is turned off during rewind operation, power will be turned off automatically after the tape has been completely rewound.

Tape counter

This indicates the amount of video tape transported as a number.

Press the COUNTER RESET button to set the counter reading to "0000" when starting recording or playing back.

Note the number on the Tape counter at the beginning and end of each program you record. This will allow you to use the counter to find the desired program later.

Counter memory function

This is useful if there is a section of tape you want to view immediately after recording or you want to return to the same point several times.

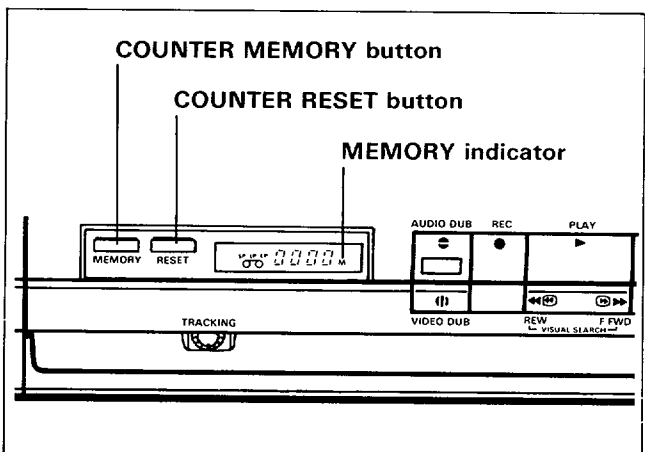

1. Press the COUNTER MEMORY button to turn on the memory indicator (M).

Note: Pressing the button once again will turn off the COUNTER MEMORY.

2. Begin recording or playing back a tape.
3. At the point where you want playback to begin, reset the tape counter to "0000" by pressing the COUNTER RESET button.
4. Continue to play or record.
5. Press the STOP button when recording or playback finishes.
6. Press the REWIND button.

The tape will automatically stop at the pre-selected "0000" position.

Actually the tape will stop slightly prior to "0000" at approximately the "9999" position to avoid missing the very first part of the program.

AUDIO DUBBING

The AUDIO DUB button on your VTR allows you to insert a new soundtrack on a previously recorded cassette using either a microphone or your component audio system.

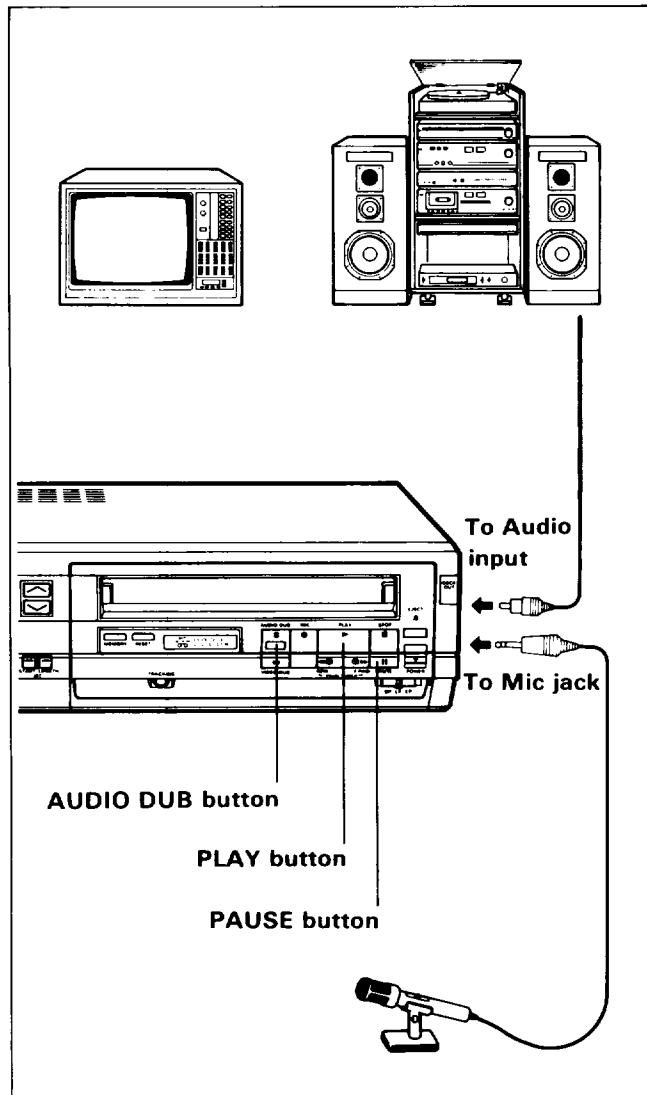

1. Connect the audio source to AUDIO INPUT jack or a microphone to MIC jack of VTR.
2. Play the recorded cassette.
3. Press PAUSE button at the point where you want to make the audio dubbing.
4. Press PLAY and AUDIO DUB buttons at the same time to audio dub.
 - During audio dub, the source that will be recorded can be heard from the TV, so adjust the input level to the VTR while monitoring the TV audio. Set the TV volume control to normal setting.
 - When using a microphone, set the TV audio off, or very low, to avoid howling type feedback.
5. Press PAUSE button again to release pause. Audio dubbing will start.

Note:

- When the AUDIO DUB button is pressed, only the recorded sound is erased and new sound is recorded; the video image is left as it is.
- Audio dubbing is not possible when safety tab on the video cassette is removed.
- When the memory indicator "M" is displayed on the Display, the Unit automatically stops at the point where the counter reaches "0000".

ORDER OF PRIORITY OF DIFFERENT INPUTS

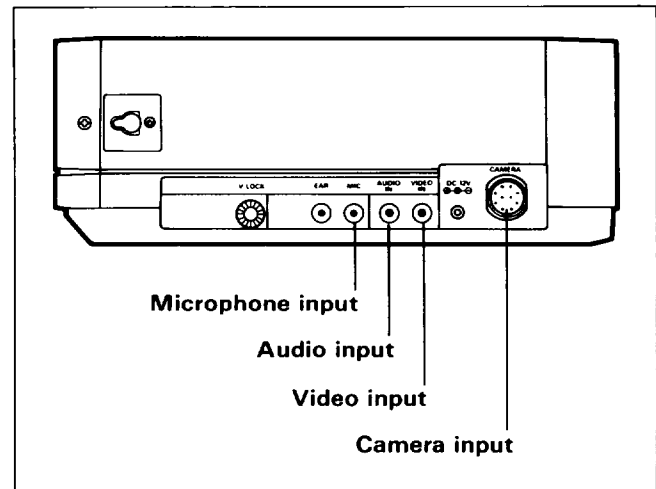

AUDIO SIGNAL

1. External equipment connected to microphone input.
2. External equipment connected to the audio input.
3. Color Video Camera connected to the camera input.

VIDEO SIGNAL

1. Color Video Camera connected to the camera input.
2. External equipment connected to the video input.

VIDEO DUBBING

When adding desired titles later to a recorded tape, a tape without distortion at the joints can be produced. Sound is left as it is. This is specially convenient to record titles on a tape previously recorded using a camera. If new video is inserted during dubbing, prior video is erased. Superimposing titles is not possible.

- Preparation Connect the video source such as camera you desire to insert from.

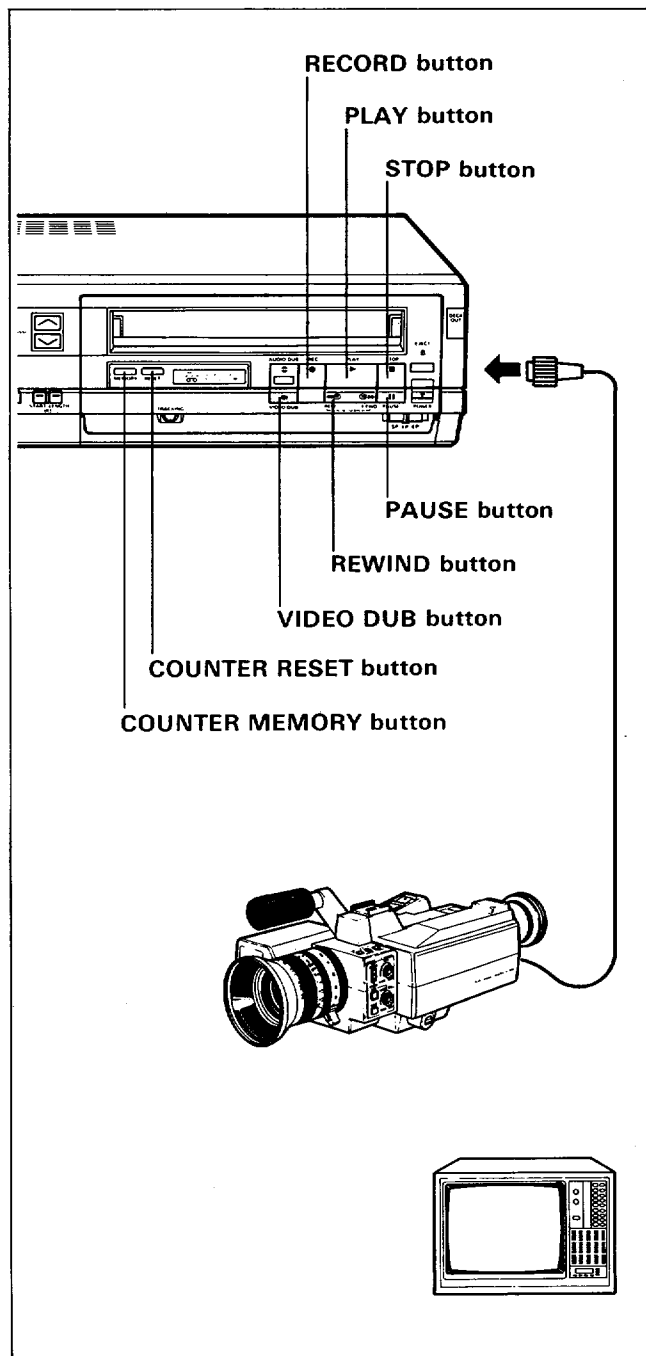

1. Play back the recorded cassette. Turn the tracking knob to minimize noise. Detect the position where video dubbing of a new scene (title, etc.) is to be applied.
2. Press the STOP button at the position desired to stop video dubbing.
3. Press the COUNTER RESET button to set the TAPE COUNTER to "0000", and then press the REWIND button to rewind the tape to the video dubbing start position.
4. Press the COUNTER MEMORY button to turn on counter memory indicator "M".
5. Again press the PLAY button to play, and press the PAUSE button when the video dubbing start position appears.
6. Press the VIDEO DUB button and PLAY button simultaneously. Now, preparation for recording the new scene (title, etc.) is completed.
7. Press the PAUSE button. Press the remote control button of the camera when the video camera is connected. Now, a new scene (title, etc.) can be recorded.
8. The unit automatically stops at the point where the counter reaches "0000".

Note:

- Video dubbing is not possible in the intermediate section between programs.
- Be sure to perform the tracking adjustment in item 1 when applying Video Dubbing to an old tape or a tape recorded using another video deck.
- Do not press the COUNTER MEMORY button to turn off counter memory indicator "M" during Video Dubbing.
- Color noise may appear on the played picture of a section to which Video Dubbing has been applied.

TIMER RECORDING

The programmable electronic clock/timer permits the unattended recording of up to 3 preselected programs, plus one program on the same day of each week. It can be preset up to 14 days in advance to record your favorite programs. It turns the unit on and off and changes channels automatically.

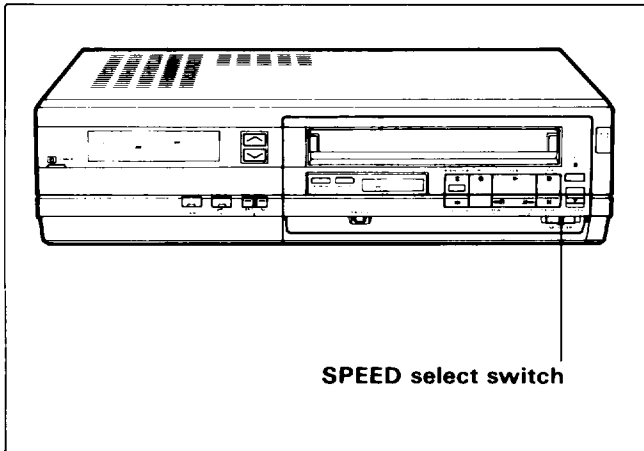

- You do not have to turn on the TV to make a recording because the VTR records TV programmes without the aid of your TV. Turn it on only when monitoring.

- Turn power on.
- Insert the Cassette.
- Set the SPEED select switch to "SP", "LP" or "EP".
Note: It is recommended to set to "SP" when recording a music program.
- Set the program timer.
"START (ON) TIME", "STOP (OFF) TIME", "DAY" etc. See below.
- Turn power off. Now recording will begin automatically at the start time.

Note:

- It is not necessary to press PLAY and RECORD buttons.
- The TIMER indicator flashes to warn that recording will not occur because cassette has not been inserted. If the safety tab on the cassette has been removed, the VTR will automatically eject the cassette when placed in the Timer mode.

Programming the timer for unattended recording

For unattended recording the timer needs to know what day to make the recording, the time to start, the time to stop, and the channel to be recorded.

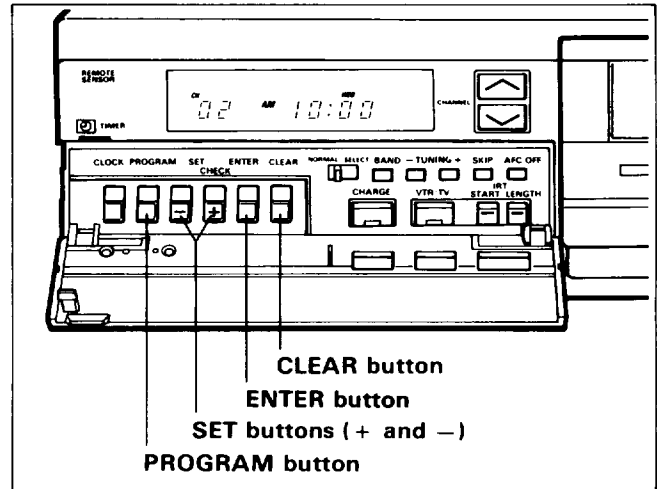

The timer is programmed using the PROGRAM, SET and ENTER buttons. The PROGRAM button selects the timer programming mode. The SET buttons advance the Program indicators, Channel, Day, Hours or Minutes for recording. The ENTER button stores them. The digits flash in sequence, so input the correct data to the flashing digits. When the ENTER button is pressed, the flashing digits will be stored in memory. If you input erroneous information by mistake when programming the timer, press the CLEAR button and input the correct information again.

- Press the PROGRAM button.

Program indicators (1 through 3 and W) flash to indicate which memory positions have not been programmed. If a memory has been programmed, its indicator will not flash.

Note: You should determine which memory positions have not been programmed before entering new programming information. New information automatically erases previous programming.

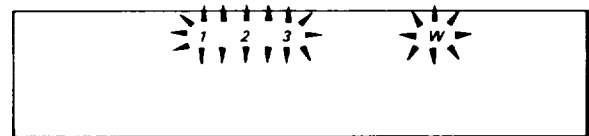

- Press the SET button (+) repeatedly until the desired program indicator lights. Press the ENTER button when the desired program number is displayed.

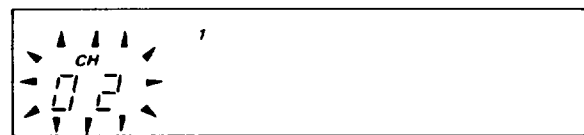

For example, diagram shows program "1" has been set.

To record on a specified day at the same time each week: Press the SET button (+) until the "W" indicator lights. Then press the ENTER button.

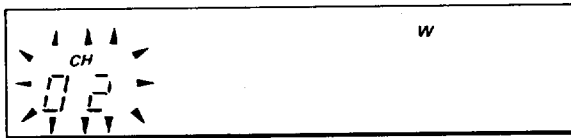

- Choose the channel to be recorded by pressing the SET (+ or -) or CHANNEL select button. Then press the ENTER button.

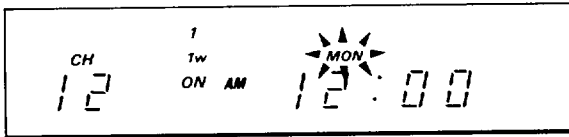

For example, diagram shows channel "12" has been set.

- Press the SET button (+ or -) to select the day of recording. Make sure desired Week indicator (1W or 2W) lights. Continuing forward will advance timer to Week two. Press the ENTER button after selecting the day of recording.

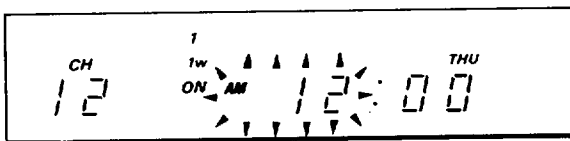

For example, diagram shows recording on Thursday within 1 week from today.

To record at the same time on Monday through Friday:

Press the SET button (+ or -) until Monday through Friday indicators light, then press the ENTER button.

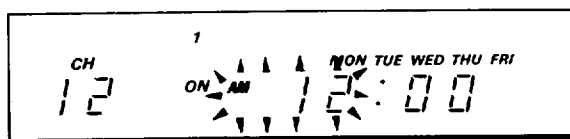

- Select the hour for recording to start by pressing the SET button (+ or -). Hold down button to advance rapidly. Press the ENTER button after selecting the hour for recording to start.

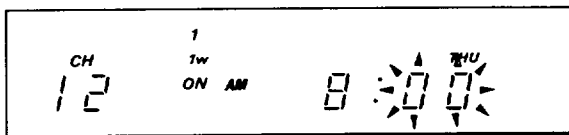

For example, the diagram shows "AM 8" hours has been set.

- Select the minutes for recording to start by pressing the SET button (+ or -). Hold down button to advance rapidly. Press the ENTER button after selecting the minute for recording to start.

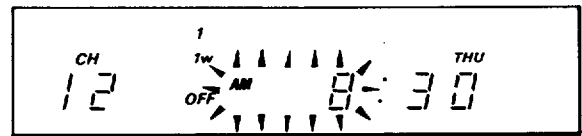

For example, the diagram shows "30" minutes has been set.

- Select the hour and minute to stop recording in the same procedures described in steps 5 and 6. Be sure to press the ENTER button after selecting the minute.

Now one programming has been completed. Display shows the start time when pressing the ENTER button. After a few seconds the display shows stop time, the display returns to clock together with letters "PROG" automatically.

"PROG" shows that timer has been programmed; it lights whenever the timer-programming is done regardless of whether the power ON/OFF. To set the next programme, repeat steps 1 through 7.

Note: If a power failure occurs and the clock display shows "--:--", programming information previously set is cleared. The programming information should be reset.

To clear a program

- Press the SET button (+) until desired program indicator lights. Then start time appears on the display.
- Press the CLEAR button. The display returns to clock to show that the programming has been cleared. Be sure to press the CLEAR button while the display shows the start or stop time. The programming does not clear if the CLEAR button is pressed when the display returns to clock.

To stop a timer recording while in progress

Press the POWER button and then press the STOP button within 10 seconds.

The program that was being recorded will be erased from the timer's memory.

To check programming

Press the SET button (+).

The program indicator "1" lights. If the program No. 1 has been already programmed, the "ON" indicator lights and the clock/timer display shows the starting time. Then the "OFF" indicator lights and the display automatically shows the time to stop recording in a few seconds with the channel number to be recorded lighting up. The display then automatically returns to the present time of day.

Programming errors

If programs overlap, the video deck will select the program with the earliest start time. When that program is over, the video deck will switch to the next program. If the start times are the same, the video deck will select the programs in numerical order.

POWER SUPPLY (For Portable VTR)

PENTAX VTR PV-R2000A can use 3 power supplies — Exclusive battery pack PV-BT01A, car battery or household AC Power (using Video Tuner or AC Adaptor/Charger).

To use the exclusive battery pack PV-BT01A (optional)

- Insert the battery pack into the battery compartment or connect the pack to battery connector (PV-BA01A), then plug into the External battery jack.

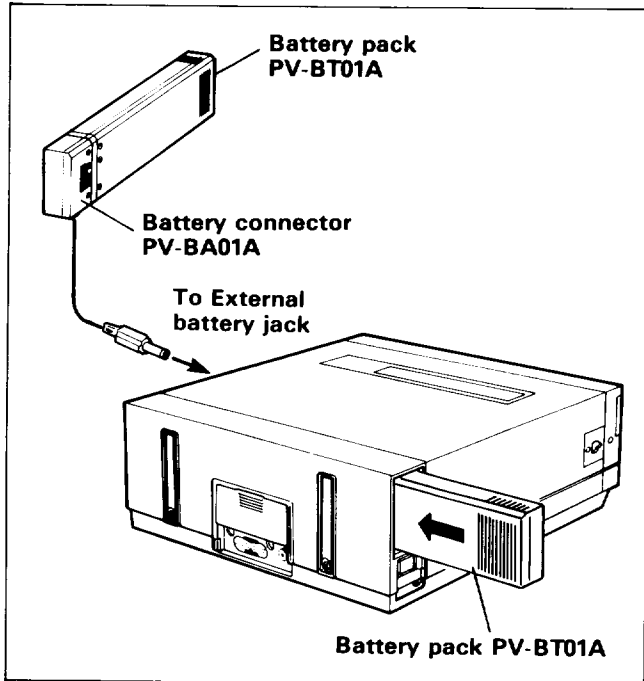

Note:

- It is important to charge the battery pack before using your portable VTR.
- When 2 battery packs are used, one in the VTR and the other connected to the External battery jack, the VTR can be operated for double the time.
- When you are using your VTR as a portable, the tape counter displays "BATT.E" when the battery is in need of recharging.

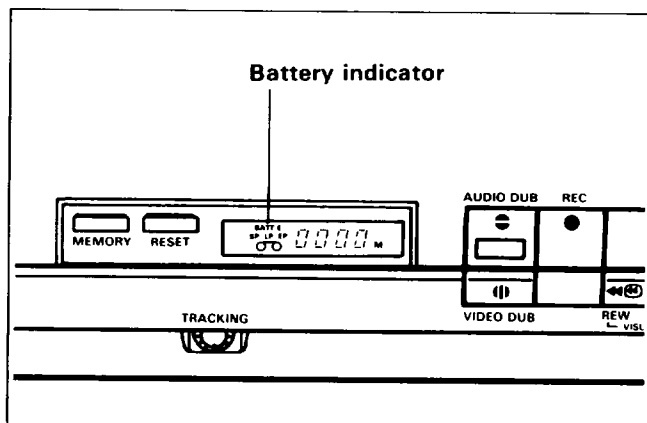

To use with car battery power (optional car battery cord PC-YC12)

Connect the car battery cord between the External battery jack of the Portable VTR and the car's cigarette lighter socket.

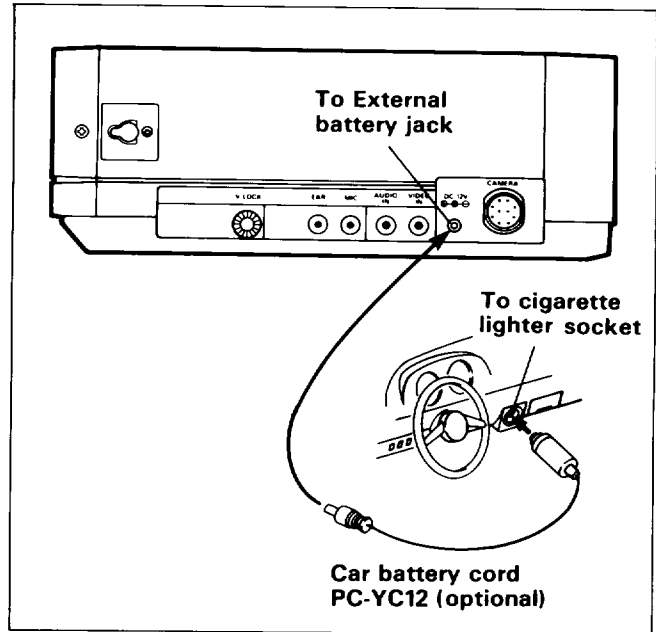

Note:

- If you are going to use the Portable VTR for a long time, leave the car's engine idling, otherwise the battery will discharge.
- It is recommended that you use a fully charged battery pack in the VTR. Car battery power tends to fluctuate, which can result in bad recordings.
- Be sure to set the unit to the stop mode when pulling out the cord.
- The PC-YC12 is for use with cars with a negative ground. Consult your PENTAX regional Service Center about using the unit with cars with a positive ground.

To use with household AC (AC Adaptor/Charger PV-A1000A Optional)

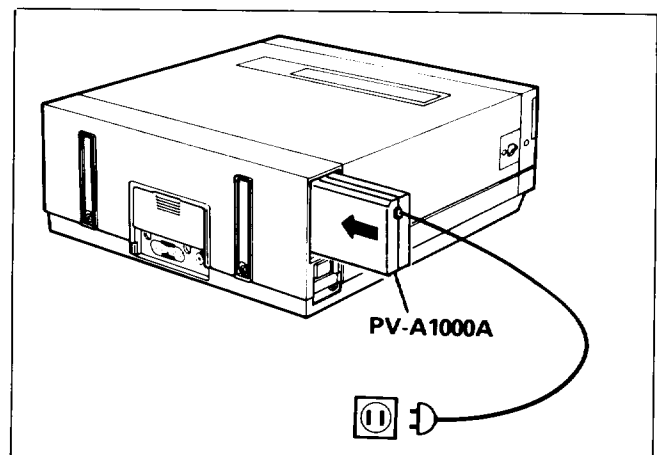

HOW TO CHARGE BATTERY PACK

PV-U2000A can be used as a battery charger for PV-BT01A, exclusive battery pack of Portable VTR.

To charge battery pack installed in Portable VTR

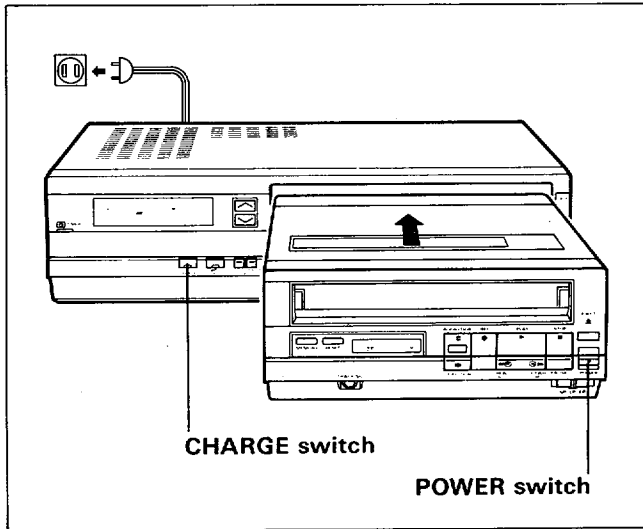

1. Insert the battery pack into the portable VTR then mount the VTR into the tuner main frame.
2. Turn off power switch of Portable VTR.
3. Press Charge switch to "ON". When charging starts, the charge indicator will go on. When charging is complete, the indicator will go off to indicate that charging is complete.

Note: If you turn on power switch of Portable VTR, the charging will stop.

To charge a battery not installed in the VTR

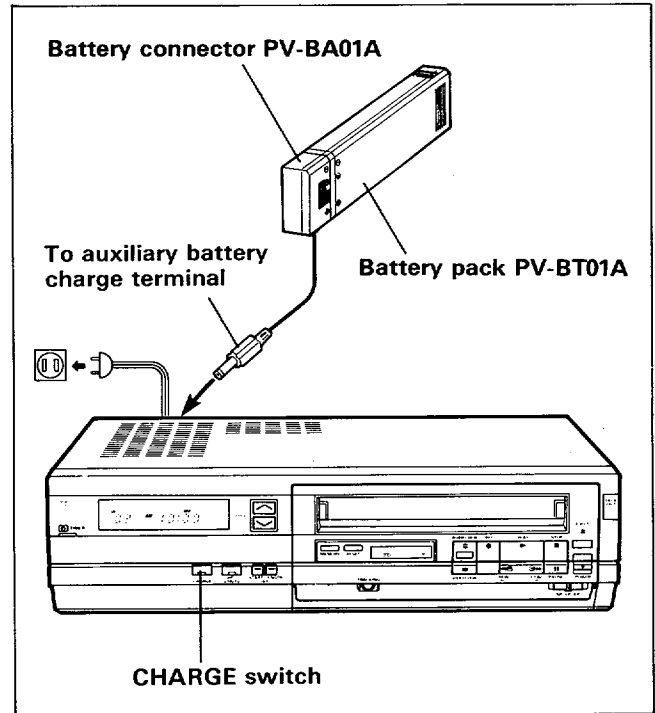

1. Connect optional battery connector PV-BA01A to battery pack PV-BT01A.
2. Connect battery connector PV-BA01A to Auxiliary battery charge terminal of VTR.
3. Press Charge switch to "ON". When charging starts, the indicator will go on. When charging is complete, the indicator will go off to indicate that charging is complete.

Note: Video Tuner and Portable VTR need not be connected when charging a battery at the auxiliary battery jack.

Note: Exclusive Battery Pack PV-BT01A can be used repeatedly by recharging it, however, its service life depends upon the conditions of use.

The following are points to be remembered.

1. Be careful not to short the plugs of battery.
2. When 2 battery packs are connected (one in the battery compartment, the other connected to Auxiliary battery charge terminal) simultaneously, the battery pack connected to Auxiliary battery charge terminal will be charged but built in battery pack will not be charged.
3. The time required for charging is approx. 1 hour.
4. Use the PV-U2000A or PV-A1000A Adaptor/Charger to charge the battery pack. Using other equipment is dangerous.
5. Power to Portable VTR is "OFF" when battery is connected to auxiliary battery charge terminal on PV-U2000A.
6. Be sure to charge battery before using.

RECORDING FROM A VIDEO CAMERA

Refer to the Instruction Manual of the Camera as well as these instructions.

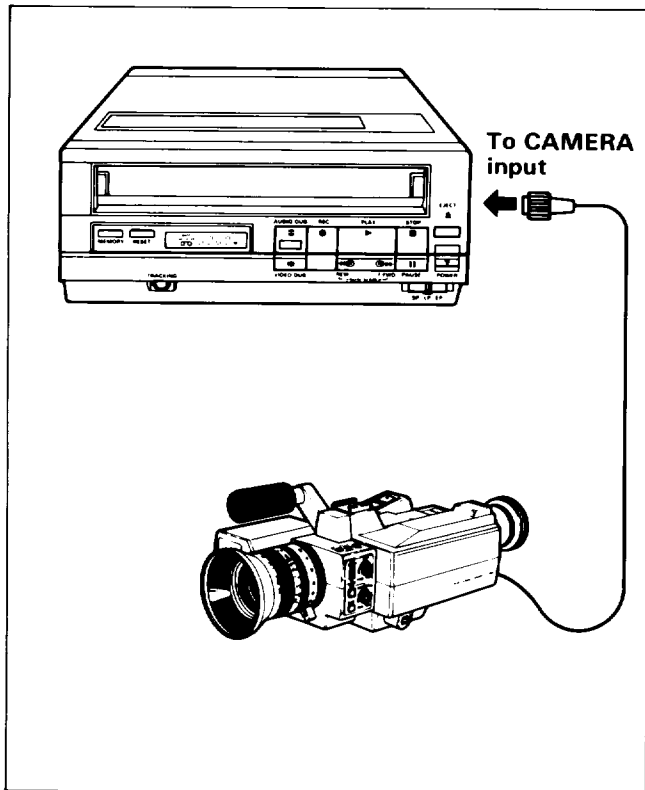

1. Insert Cassette.
2. Select SPEED select switch to "EP", "LP" or "SP".
3. Adjust aperture, focus etc. on camera. Refer to Instruction Manual of the Video Camera.
4. Press RECORD button and PLAY button simultaneously.
5. Press Remote Control button on Camera. Recording begins.
6. Press Remote Control button again, to pause during recording.
7. Press STOP button to stop recording.

Note: Plug an earphone into the earphone jack of the VTR to monitor sound. Sound cannot be monitored when the earphone is connected to the earphone jack of the video camera.

Camera Select Switch

When using a video camera without a record check function, set the camera select switch on the bottom to the "N" position.

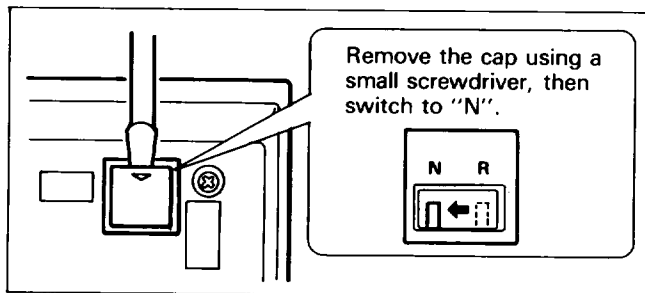

Pause operation with camera remote pause control

When a camera is connected and the VTR is placed in the RECORD mode, pause cannot be released with the VTR PAUSE button. It must be released using the camera remote pause control (Camera has pause priority in recording).

Power save function

Power consumption in the record pause mode is almost the same as that in recording during camera recording using the battery pack. The VTR enters the power save mode when the record pause mode continues for 5 minutes or more, and reduces power consumption to approx. 1W. The pause indicator flashes in the power save mode.

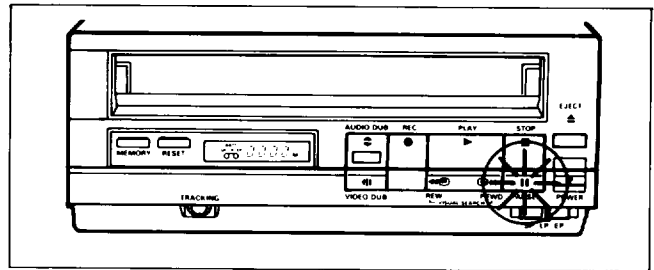

Pause indicator flashes.

- Recording starts with the remote control button of camera pressed.
- Operation stops with the stop button pressed.

The unit also enters the power save mode with the power save switch of the camera set to "POWER SAVE". In this case, recording starts again when the power save switch of the camera is returned to "NORM" and the remote control button of the camera is pressed.

* The power save function does not work when the VTR is operating with the video tuner/timer.

When Connecting the Portable VTR to a TV

Connect the portable VTR directly to a TV when you are travelling, and you can play back the tape immediately after it is recorded or view the picture being recorded on the TV screen.

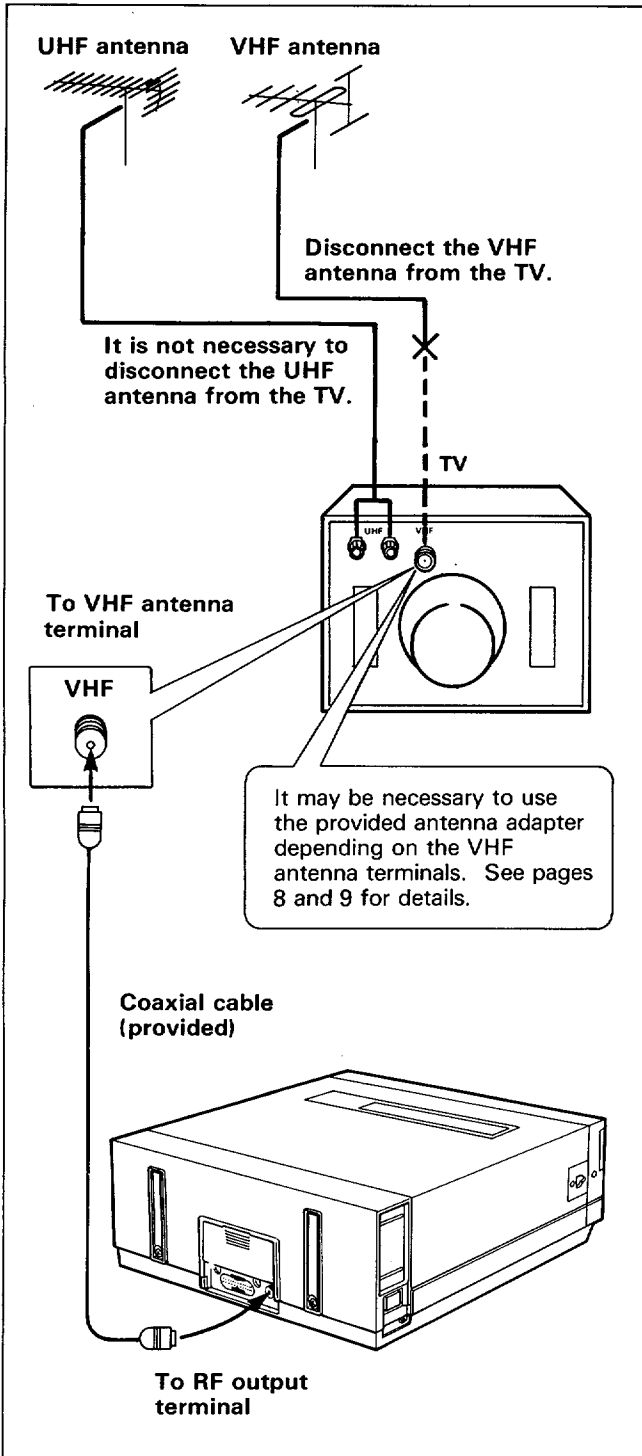

REMOTE OPERATION

You can operate the VTR from a distance using the Infrared Remote Control unit.

Power source of infrared remote control unit

The infrared remote control unit is powered by two batteries (size AA). The life of the batteries is about one year although it depends on the numbers of times the unit is used. Replace the batteries when operation is not possible or when the distance becomes too short.

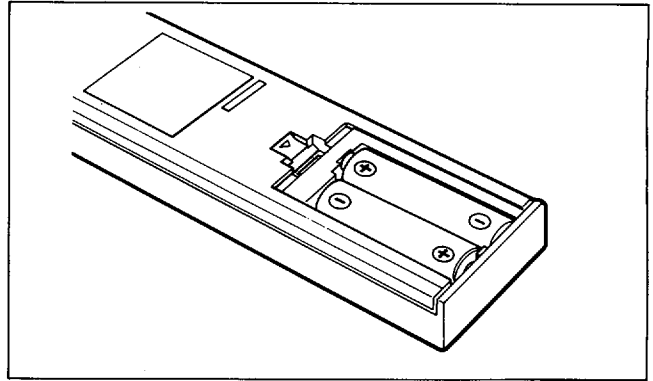

Operation of remote control

To use the infrared remote control unit aim it at the receiver on the front panel of the VTR.

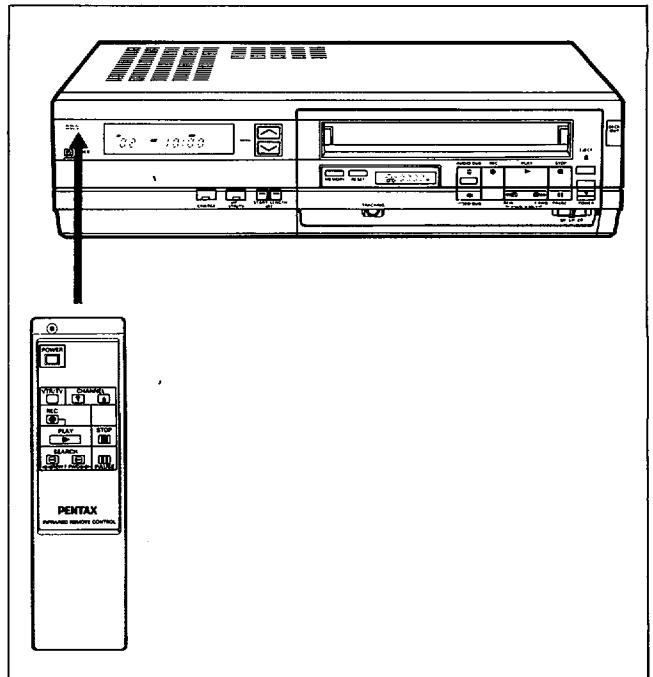

Note: The infrared rays will bounce off the walls and eventually reach the receiver on the VTR, but for best results transmit rays directly to the receiver.

HEAD CLEANING

- Picture playback may become blurred or be interrupted while the TV program received is clear. This does not mean that the recorded program has been erased.
- Dirt accumulated on the head after long periods of use causes this problem. In this case, head cleaning requiring highly technical care is necessary.
- For head cleaning, consult the nearest dealer or VTR Service Center for recommendations.

PERIODIC MAINTENANCE

The VTR is a precision electromechanical device which will require periodic maintenance after a period of normal use. We expect that no maintenance other than head cleaning will be required during the warranty period by most users, unless the VTR is heavily used or seldom used. Normal maintenance is the responsibility of the user, although defective parts are covered during the warranty period. Consult your VTR Service Center to determine recommendations for normal maintenance based on your location, use patterns and machine age.

PROBLEM GUIDE

PROBLEM	THINGS TO CHECK	SOLUTION
No power	<ul style="list-style-type: none"> • Is power cord connected? 	<ul style="list-style-type: none"> • Connect power cord with AC outlet.
Unit does not operate with PV-BT01A battery.	<ul style="list-style-type: none"> • Is battery fully charged? 	<ul style="list-style-type: none"> • Charge or replace battery.
Timer recording is not possible.	<ul style="list-style-type: none"> • Is the program timer set correctly? • Is the POWER switch set to "OFF"? • Is the record safety tab missing? 	<ul style="list-style-type: none"> • Set the program timer correctly. • Set the POWER switch to "OFF". • Place cellophane tape over missing safety tab.
REC mode cannot be engaged.	<ul style="list-style-type: none"> • Is the record safety tab missing? 	<ul style="list-style-type: none"> • Place cellophane tape over missing safety tab.
Picture is poor on playback.	<ul style="list-style-type: none"> • Is the TV channel selector on the proper channel? • Is the TV fine tuning set correctly? 	<ul style="list-style-type: none"> • On playback, the TV channel selector should be on channel 3 or 4. • Fine tune your TV.
Noise in picture on playback	<ul style="list-style-type: none"> • Are Video Heads clean? 	<ul style="list-style-type: none"> • Head cleaning is necessary.
No picture on playback	<ul style="list-style-type: none"> • Is the TV set to the proper channel? 	<ul style="list-style-type: none"> • Set to correct channel, CH3 or 4. (for your video channel)
Playback picture is partially noisy.	<ul style="list-style-type: none"> • Is the TRACKING control set to center position? 	<ul style="list-style-type: none"> • Adjust TRACKING control for better picture.
TV program cannot be recorded.	<ul style="list-style-type: none"> • Is Video Camera, etc. disconnected? 	<ul style="list-style-type: none"> • Disconnect Video Camera, etc.
Off-the-air TV programs cannot be seen.	<ul style="list-style-type: none"> • Is connection correct? 	<ul style="list-style-type: none"> • Connect correctly.
Built-in battery of Portable VTR cannot be charged.	<ul style="list-style-type: none"> • Is the power switch of Portable VTR set to "OFF"? • Is the spare battery disconnected? 	<ul style="list-style-type: none"> • Set the power switch of Portable VTR to "OFF". • Remove the spare battery.

SPECIFICATIONS

Recording:	Rotary two head Helical Scan Azimuth Recording									
Video:	NTSC Color EIA Standard									
Cassette:	VHS Type									
Heads:	2 video heads for SP/LP/EP 1 Full track audio/video erase head 1 Combination head for control track, audio erase and audio record/play (3 heads/single housing)									
Tape Speed:	33.35 mm/sec (SP), 16.67 mm/sec (LP), 11.12 mm/sec (EP)									
Tape Width:	12.7 mm									
RF Output:	Channel 3 or Channel 4									
RF Input:	VHF 75 ohm, UHF 300 ohm									
Tuning Range:	VHF LOW, CH2 ~ 6 (54 MHz - 88 MHz) VHF HIGH, CH7 ~ 13 (174 MHz - 216 MHz) VHF MID. CH A-2, A-1 and A ~ 1 (108 MHz - 174 MHz) CATV VHF SUPER CH J ~ W (216 MHz - 300 MHz) CATV UHF CHANNELS, 14 ~ 83 (470 MHz - 890 MHz)									
Video Input:	0.5 - 2 Vp-p 75 ohm Unbalanced									
Video Output:	1 Vp-p 75 ohm Unbalanced									
Video Recording S/N:	Better than 46 dB (SP), Better than 43 dB (LP), Better than 40 dB (EP)									
Horizontal Resolution:	240 lines (SP), 230 lines (LP), 230 lines (EP)									
Audio										
Input:	Line: 316 mV rms (-7.8 dB) 50 kohm	Mic: 0.3 mV rms (-69 dB)								
Output:	Line: 316 mV rms (-7.8 dB) 1 kohm	Earphone: 39 mV rms (-26 dB)								
S/N Ratio:	43 dB (SP)									
Frequency Range:	50 Hz to 10 kHz (SP)									
Power:	DC 12V (Portable VTR) AC 120V 60 Hz (Portable VTR + Tuner)									
Power Consumption:	4.8W Nominal (recording with DC 12V power supply) (Portable VTR) 40W (Portable VTR + Tuner)									
Cabinet Size and Weight:	<table border="0"> <tr> <td>9-3/16"(W) x 3-3/4"(H) x 10-1/16"(D)</td> <td rowspan="3">} (Portable VTR)</td> </tr> <tr> <td>23.3(W) x 9.5(H) x 25.6(D) cm</td> </tr> <tr> <td>5.7 lbs (2.6 kg)</td> </tr> <tr> <td>17-1/8"(W) x 4-1/2"(H) x 11-5/8"(D)</td> <td rowspan="3">} (Portable VTR + Tuner)</td> </tr> <tr> <td>43.5(W) x 11.5(H) x 29.6(D) cm</td> </tr> <tr> <td>15.6 lbs (7.1 kg)</td> </tr> </table>		9-3/16"(W) x 3-3/4"(H) x 10-1/16"(D)	} (Portable VTR)	23.3(W) x 9.5(H) x 25.6(D) cm	5.7 lbs (2.6 kg)	17-1/8"(W) x 4-1/2"(H) x 11-5/8"(D)	} (Portable VTR + Tuner)	43.5(W) x 11.5(H) x 29.6(D) cm	15.6 lbs (7.1 kg)
9-3/16"(W) x 3-3/4"(H) x 10-1/16"(D)	} (Portable VTR)									
23.3(W) x 9.5(H) x 25.6(D) cm										
5.7 lbs (2.6 kg)										
17-1/8"(W) x 4-1/2"(H) x 11-5/8"(D)	} (Portable VTR + Tuner)									
43.5(W) x 11.5(H) x 29.6(D) cm										
15.6 lbs (7.1 kg)										
Accessories:	<table border="0"> <tr> <td>1 - Coaxial cable with F-type connectors</td> <td>1 - Infrared remote control unit</td> </tr> <tr> <td>1 - UHF twin lead</td> <td>2 - Batteries</td> </tr> <tr> <td>1 - Matching transformer 300 - 75 ohm</td> <td>1 - Shoulder belt</td> </tr> <tr> <td>1 - Matching transformer 75 - 300 ohm</td> <td>1 - Earphone</td> </tr> </table>		1 - Coaxial cable with F-type connectors	1 - Infrared remote control unit	1 - UHF twin lead	2 - Batteries	1 - Matching transformer 300 - 75 ohm	1 - Shoulder belt	1 - Matching transformer 75 - 300 ohm	1 - Earphone
1 - Coaxial cable with F-type connectors	1 - Infrared remote control unit									
1 - UHF twin lead	2 - Batteries									
1 - Matching transformer 300 - 75 ohm	1 - Shoulder belt									
1 - Matching transformer 75 - 300 ohm	1 - Earphone									

Design and Specifications subject to change without notice.

PENTAX

PENTAX CORPORATION. 35 Inverness Drive East Englewood, CO 80112
Service information : (303) 799-8000

PENTAX CORPORATION. 1101 Stewart Ave. Garden City, NY 11530
Service information : (516) 222-0830

PENTAX CORPORATION. 350 East Devon Ave. Itasca, IL 60143
Service information : (312) 250-9000

PENTAX CORPORATION. 8363 Reseda Blvd. Northridge, CA 91324
Service information : (818) 701-5080

Free Manuals Download Website

<http://myh66.com>

<http://usermanuals.us>

<http://www.somanuals.com>

<http://www.4manuals.cc>

<http://www.manual-lib.com>

<http://www.404manual.com>

<http://www.luxmanual.com>

<http://aubethermostatmanual.com>

Golf course search by state

<http://golfingnear.com>

Email search by domain

<http://emailbydomain.com>

Auto manuals search

<http://auto.somanuals.com>

TV manuals search

<http://tv.somanuals.com>