

Instruction Manual



- | | |
|-----------------|-------------------------------|
| PLP-601 | Automatic Self-leveling Laser |
| PLP-602 | Automatic Self-leveling Laser |
| PLP-601R | Automatic Self-leveling Laser |
| PLP-602R | Automatic Self-leveling Laser |

PENTAX Industrial Instruments Co., Ltd.

2-5-2 Higashi-Oizumi / Nerima-ku, Tokyo 178-0063, Japan

Tel. +81 3 5905 1222 / Fax +81 3 5905 1225

E-mail: international@piic.pentax.co.jp

Website: www.pentax.co.jp/piic/survey

www.pentaxsurveying.com

Safety Precautions (must be followed)

The following items are intended to prevent possible injury to the user or other people and/or damage to the instrument.

These safety precautions are important to the safe operation of this product and should be observed at all times.

•*Distinctive Displays*

The following displays are used to distinguish precautions by the degree of injury or damage that may result if the precaution is ignored.



WARNING

Items indicated by this indication are precautions which, if ignored, could result in death or serious injury.



CAUTION

Items indicated by this indication are precautions which, if ignored, may result in injury or material damage.

- The term 'injury' here refers to injuries such as cuts, burns or electric shock, the treatment of which will not likely require hospitalization or longterm attention.
- 'Material damage' refers to damage to facilities, buildings, acquired data, etc.

1. For safety in handling this laser product, operate it according to the instructions shown on the warning label, the location of which is shown in the following illustration.

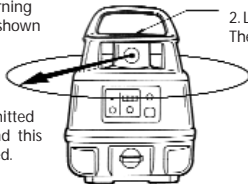

2. Laser warning label
The label is put on the ceiling.

3. Laser is emitted
from here and this
part is rotated.



WARNING

- While the instrument is operating, be careful not to expose your eyes to the emitting laser beam (red light source). Exposure to a laser beam for a long time may be hazardous to your eyes. (Laser beam: Equivalent to class 2 Laser level)
- Do not try to dismantle the instrument. Have it repaired by your dealer or authorized repair shop. Dismantling it by yourself may worsen the trouble.



CAUTION

- Do not stand on the carrying case. The case could turn over causing the person standing on it to fall.
- When attaching the instrument to a tripod, make sure the instrument is securely fixed to the tripod and then securely tighten the tripod leg clamps. If not securely fastened and/or tightened, the main unit could fall off or the tripod could fall over.
- When carrying the tripod, be careful so that the tripod shoes do not strike anyone.
- When setting the tripod, make sure not to stab someone's hand or foot with the tripod shoes.
- Operate this laser product with the height of laser avoiding that of eyes of car drivers and pedestrians.
Avoid putting the laser on a highly reflective material such as mirror.
When disposing of this instrument, take a measure such as breaking the battery cap so that the laser will not be emitted.

Precautions

The instrument should not be stored or used in extreme temperatures or job on a place subject to rapid change of temperature.

(Refer to the ambient temperature range) The instrument may not function properly if used out of the ambient temperature range.

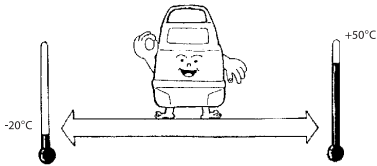

Put into the carrying for storage and place in a dry area not subject to vibration, dust or high moisture.



When storage and usage temperatures are widely different, leave the instrument in the case until it can adjust to the surrounding temperature.

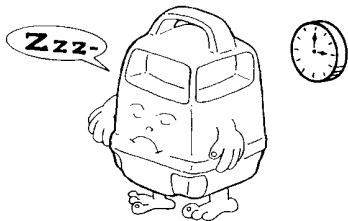

The detector (option) may react to the Laser beam and further react to the Fluorescent lamp, Site lamp, modulated light or an electric wave (in or near the airport etc.) and so correct measurement is sometimes not performed near these places. In these cases, please measure again after stopping or cutting these modulated light or wave etc.

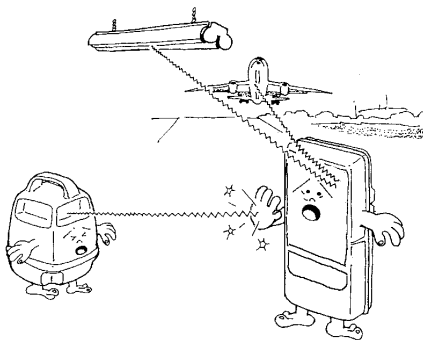

The instrument should be transported or carried carefully to avoid impact or vibration.

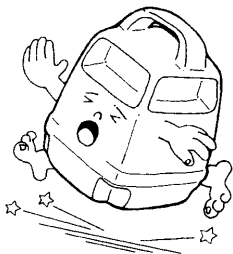

The instrument should be stored in the carrying case and packed with cushioning material and handled with care as 'Fragile'.

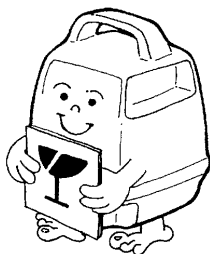

Check the 'check and adjustment of the datumpoint' of page 35 in this manual and be sure to check to see if error exists before the instrument is used. After the instrument has been stored a long time or it has suffered an impact or vibration, be sure to check to see if trouble exists before use. If any trouble exists, adjust or have it repaired.

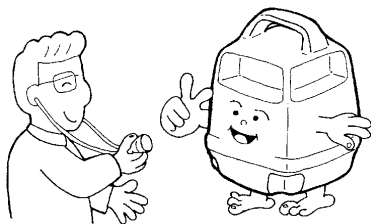

Be sure to observe the items in the instruction manual for proper use of the instrument.

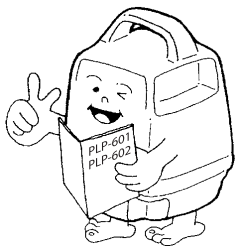

Please replace attached batteries with new ones before you work because their voltage may be low.

CONTENT

Safety Precautions

Precautions

- **1. For proper use of the instrument** **11**
 - 1.1 Standard configuration
 - 1.2 Description
 - 1.3 Unpacking
 - 1.4 Battery insertion

- **2. Display and Keypad** **17**
 - 2.1 Keypad
 - 2.2 Role of keys
 - 2.3 Warning display

- **3. Preparation for measurement** **22**
 - 3.1 Setting up the tripod
 - 3.2 Setting up the instrument
 - 3.3 Arranging the detector

- **4. Measurement** **26**
 - 4.1 Operating the instrument
 - 4.2 Operating the detector: LS3

- **5. Maintenance and adjustment** **33**
 - 5.1 Maintenance after use
 - 5.2 Check and adjustment of the datum point
 - 5.3 Troubleshooting

- **6. Specifications** **39**

- **7. Notice to the user of this product** **40**

1. For proper use of the instrument

1.1 Standard configuration

- ① The instrument (PLP-601 / PLP-602 / PLP-601R / PLP-602R)
- ② Detector (LS6)
- ③ Rod Adapter (LA6)
- ④ D type battery (PLP-601 / PLP-602)
- ⑤ Charger (PLP-601R / PLP-602R)
- ⑥ Rechargeable Ni-MH battery built in the body (PLP-601R / PLP-602R)
- ⑦ Carrying Case
- ⑧ Instruction Manual

1.2 Description

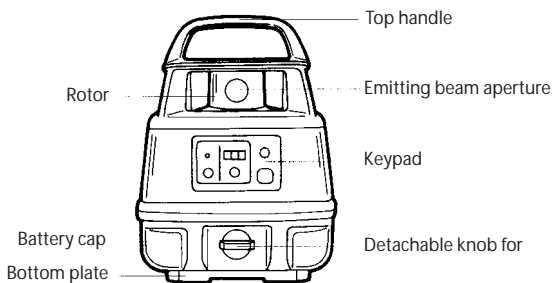
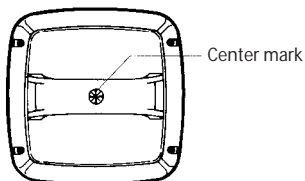

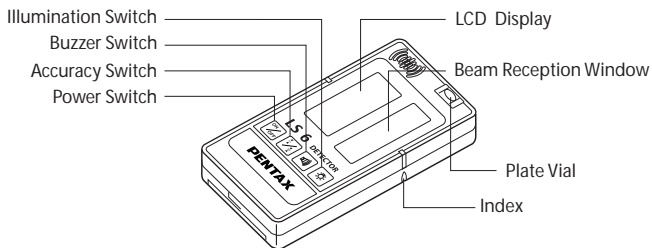

Rod Adapter LA6

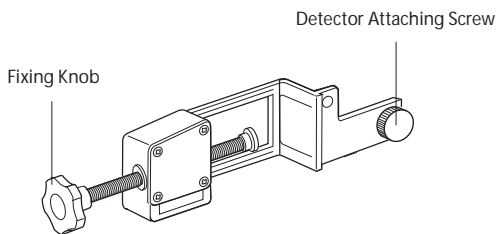

1.3 Unpacking

Taking the instrument out of the carrying case

- ① Gently set down the carrying case so that its cover is upward.
- ② Unlatch and open the case while pushing the latch lock.
- ③ Remember how the instrument is placed in the case before removing it.

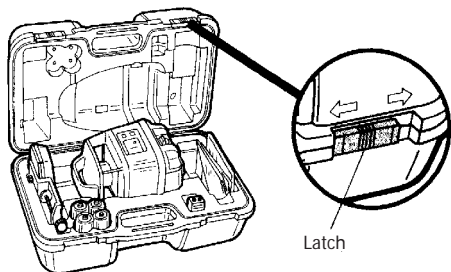

Putting the instrument into the carrying case

- ① Set down the carrying case and open the cover
- ② Gently put the instrument into the case
- ③ Close the case and secure the latch

NOTE:

- When taking out the instrument, be sure to secure it with your hands.
- When putting the instrument into the case, be sure to turn the power switch off.
- If the case cover is difficult to close, check again whether or not the instrument is properly inside the case.

1.4 Battery insertion

Battery insertion for the instrument

- ① Turn the detaching knob for battery cap counterclockwise and remove the cap from the instrument.
- ② Insert 4 pcs D type batteries into the battery box according to its (+) and (-) marks. (PLP-601 / PLP-602)
- ③ While holding the instrument with one hand, push the battery cap into the battery box and attach it by turning the knob clockwise.

Battery insertion for the detector

LS6 Detector

- ① Slide the battery cover while pushing its  mark and remove it.
- ② Insert the accumulated dry battery into the battery holder according to its (+) and (-) marks.
- ③ Slide the battery cover to reinsert it.

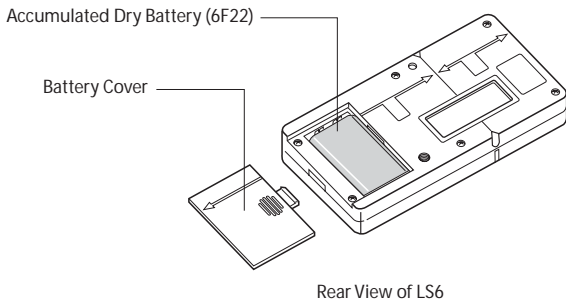

Rear View of LS6

CAUTION:

- Pay attention to the battery holder's (+) and (-) marks for proper battery insertion.
- Batteries must be of the same type. Do not use a combination of batteries whose remaining capacity differs.

2. Display and Keypad

2.1 Keypad

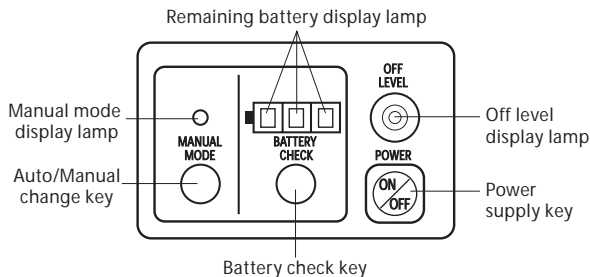

2.2 Role of keys

(1) Power supply key

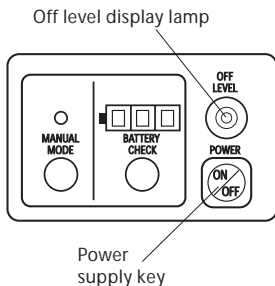

- ① Pushing power supply key begins the automatic self-leveling.
- ② The off level display lamp blinks in red during activating the leveling. The blink interval becomes longer gradually as the leveling comes near to completion.
- ③ The color of the off level display lamp turns to green when the leveling is completed, a rotor begins to rotate and then a laser beam is emitted horizontally. The lamp (green) is turned off about 5 seconds later after the leveling completion.

(2) Battery check key

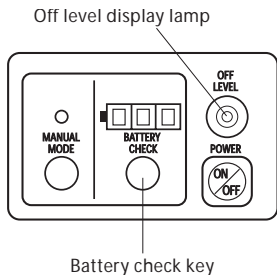

- ① The consumption status of a battery can be confirmed by the remaining battery display lamp when the battery check key is pressed after turning on the power supply.
- ② The remaining battery display lamp is turned off about 15 seconds later after the battery check key is pressed.

Remaining battery display lamp



Turning on 3 green lamps



Turning on 2 green lamps



Turning on 1 green lamp



Blink of 1 red lamp



Turning on 1 red lamp

Workable enough.

Remaining capacity is little.
Prepare the spare battery.

Battery is to be replaced.

Replace the battery.

NOTE:

- When 4 pcs rechargeable batteries type D are used, only 2 green lamps are turned on even if they are fully charged.

(3) Auto/manual change key

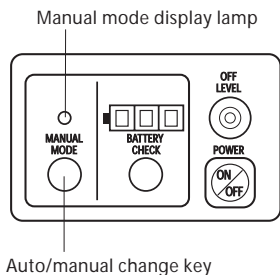

- ① When the Auto/manual change key is being pressed for more than 2 seconds, the manual mode display lamp is turned on in red.
- ② The automatic self-leveling begins and the automatic self-leveling function stops after completion of automatic leveling.
- ③ During the manual mode, the laser beam is emitted even if the instrument is tilted largely (out of correction area).
- ④ When the Auto/manual change key is pressed again, the manual mode display lamp is turned off, the manual mode is reset and returns to normal function.

NOTE:

- Simple grade setting can be done by manual mode, but usually performed without stopping the automatic self-leveling function (without pressing the Auto/manual change key).
During the manual mode, the horizontal accuracy of emitted laser beam is not guaranteed.
- During the manual mode, the manual mode display lamp is turned on in red.

(4) Switching the rotation speed

- Please switch the rotation speed after turning off the instrument power supply.

[From 300 to 600 rpm]

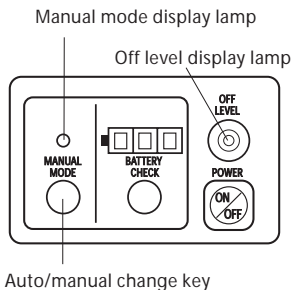

- ① Push the power supply key while pushing the Auto/Manual change key.
- ② Manual mode display lamp and off level display lamp blink in red a few seconds and tell that the rotation is switched to 600 rpm.
- ③ The switched rotation speeds is memorized even if power supply is turned off.

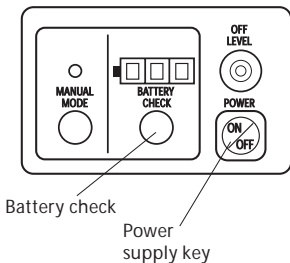

- ④ Turn off the power supply and then push the power supply key while pressing the battery check key to return to 300 rpm.

NOTE:

- When the instrument is set to 600 rpm, the Manual mode display lamp and off level display lamp blink in red for a few seconds after power supply is turned on.
- Rotation speed is set to 300 rpm on factory shipping.

2.3 Warning display

Off level display lamp turns on in red as warning display and rotation of rotor and emission of laser beam stop under following situation.

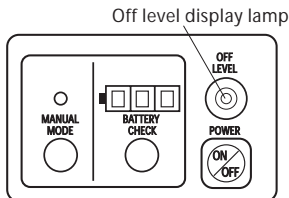

(1) **When the instrument is tilted more than $\pm 5.7^\circ$ ($\pm 10\%$) then power supply is turned on**

→ Turn off the power supply and install the instrument horizontally (within $\pm 5.7^\circ$) and turn on the power supply again.

(2) **When some shock is added to the instrument while at work**

→ Turn off the power supply and turn on the power supply again.

• If the work is to be continued, perform this procedure after resetting the laser beam at the "reference mark".

(3) **When, status that the automatic self-leveling function does not become stable continues for about 3' after power supply is turned on**

→ Turn off the power supply and turn on the power supply again.

But warning is displayed farther, change the setting place of instrument or stop the construction machines which may be the cause of vibraton.

NOTE:

- After warning is displayed (Off level display lamp turns on in red), if no key is pressed for about 10', power supply is turned off automatically.
- At above (2), warning display does not work while automatic self-leveling function stops (Off level display lamp turns on in red).

3. Preparation for measurement

1.1 Setting up the tripod

[Arranging the tripod]

- ① Prepare the normal tripod for Level instrument.
- ② The dome head type and elevation type tripod for Level instrument can be used.

[Selection of the place to set up the tripod]

Be sure to select a place where the job will not be interrupted and the instrument can be set to have almost same distance to each point to be measured.

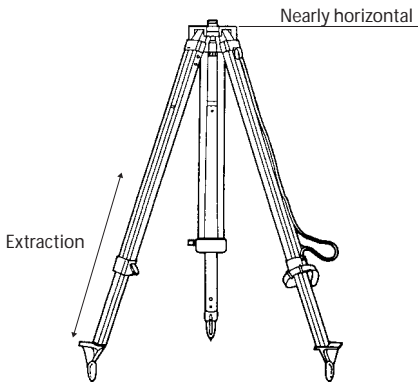

[Setting up the tripod]

- ① For an extension tripod, adjust the legs to a suitable length and secure the leg clamps.
- ② Spread the legs to a proper extent for the tripod head to be nearly level and push them into the ground.
- ③ Should the tripod head be off level, adjust it by expanding the legs accordingly.

NOTE:

- For a tripod setting place, be sure to select a place where the ground or floor has less vibration and there is no fear of upset.
- To set the tripod on a slippery floor, the legs must be secured. Use a chain (or similar) to keep the legs from spreading.

3.2 Setting up the instrument

[Mounting on the tripod]

Mount the instrument on the tripod head and while supporting the instrument with one hand, secure it using the tripod center screw.

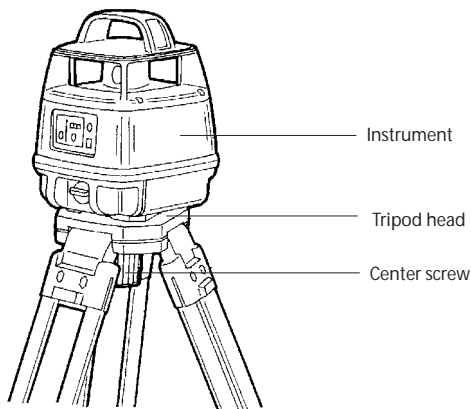

NOTE:

- Also when removing the instrument from the tripod, loosen the center screw while supporting the instrument with one hand.
- Do not leave the instrument mounted on tripod without the center screw being tightened. It may cause the instrument to fall and be damaged.

3.3 Arranging the detector

[Installing the rod adapter LA6]

LS6 detector

- ① Mount the instrument on the rod adapter so that the guide pin of the rod adapter is inserted into the guide hole in the back of the detector.
- ② Tighten the attaching screw of the rod adapter into the detector.

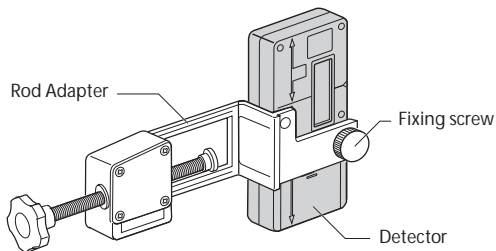

NOTE:

- The rod adapter is to be used when the detector is used together with a staff or plain rod.

4. Measurement

4.1 Operating the instrument

[Starting the operation]

- ① Press the power supply key.
- ② Automatic self-leveling function works and leveling begins automatically. When leveling is completed, the rotor begins to rotate and emits invisible laser beam.

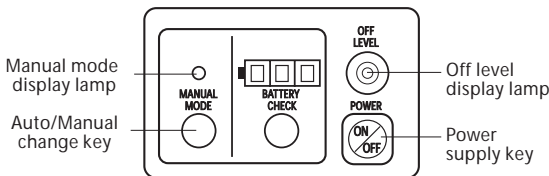

NOTE:

- Before operating the instrument, perform the 'Check and adjustment of the datum point' on page 35.
- Before operating the instrument, confirm that the manual mode display lamp is not turned on in red. While automatic self-leveling function, (the manual mode display lamp turns on in red) pay attention that the horizontal accuracy of emitted laser beam is not guaranteed.
- When the status that the automatic self-leveling function is not stable continues for about 3', the off level display lamp turns on in red and rotation of rotor and the emission of laser beam stop.
- While not in operation, be sure to turn the instrument's power switch off.



WARNING

- While the instrument is operating, be careful not to expose your eyes to the emitting laser beam (red light source). Exposure to a laser beam for a long time may be hazardous to your eyes. (Laser beam: Equivalent to class 2 Laser level)

4.2 Operating the detector: LS6

[Power switch]

- ① Push the power switch to turn on the power to the detector.
- ② Pushing the power switch again turns off the power.

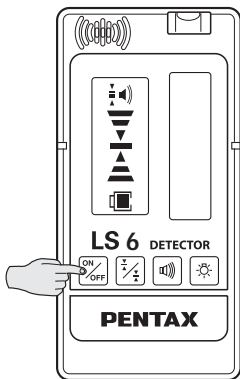

NOTE:

- The liquid crystal displays all light up as shown in the above figure with the power switch pressed. This permits checking for any defects in the liquid crystal display.
- The battery's remaining capacity is always indicated with the power turned on. Check when to replace the battery, referring to the figure on the above.
- The power turns off automatically if no laser beam is received and any key not operated for about ten minutes. To turn on the power again, push the power key once again.

[Selecting the reference level detecting accuracy]

Push the detection accuracy selection switch to select the needed detection accuracy.

High accuracy detection:

To be selected for detecting the reference level with accuracy.

Low accuracy detection:

To be selected if high accuracy is not needed or when stable reference level cannot be obtained due to slight vibration at job site.

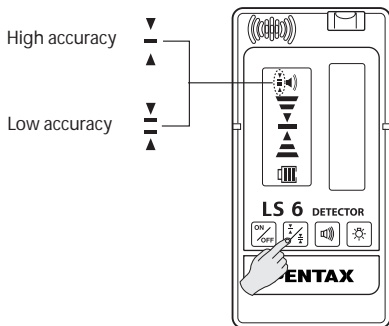

NOTE:

- For the detection accuracy to be selected, check with the mark in the liquid crystal display (see the figure on the above).
- The detection accuracy alternates each time the detection accuracy selection switch is pressed.
- High detection accuracy is initiated when the power turns on.
- If the point to be measured is distant, the reference level may not be displayed stably by the influence of heat waves shimmering or the instrument slightly vibrating. Under such conditions, select 'Low detection accuracy'.

[ON or OFF of the beam reception buzzer]

Push the beam reception buzzer switch to select either the buzzer sounding or silenced.

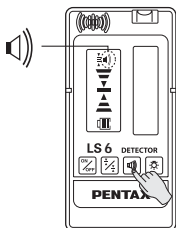

[Illuminating the display]

- ① Push the illumination switch to illuminate the display.
- ② Pushing the switch again turns off the illumination.

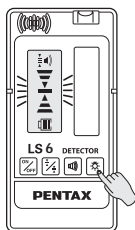

NOTE:

- For either the buzzer sounding or silencing to be selected, check with the mark in the liquid crystal display (see the figure on the above).
- The buzzer sounding/silencing alternates each time the buzzer switch is pushed.
- The buzzer sounding is initiated when the power turns on.
- The illumination turns off automatically if no laser beam is received and any switch is not operated for about one minute.
To illuminate the display again, push the illumination switch once more.

[Detecting the reference level]

At the measuring point, set the position of the detector nearly to the height of the beam emitting aperture of the instrument.

Position the detector where the buzzer sound (or the beam reception display appears) by directing the detecting display nearly toward the instrument and moving the detector up and down.

Move the detector up and down again according to the beam reception display (or the buzzer) and obtain the reference level.



Move the detector down as it is positioned high.
The buzzer sound beeps at short intervals.



This is the reference position.
The buzzer sound beeps continuously.



Move the detector up as it is positioned low.
The buzzer sounds lasting beeps intermittently.

NOTE:

- When detecting the reference level, the detector should face the instrument in the range of about 40°, to the right and left from the front.

[Direct marking]

After the reference level has been detected, mark a line along the detector's index, or its top or bottom end.

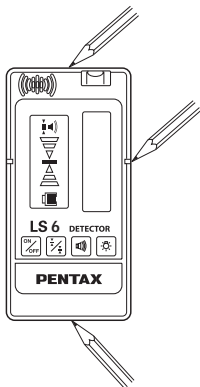

[Plain rod marking]

After the reference level has been detected, mark a line along the plain rod's top or bottom end.

NOTE:

- If a line was marked along the detector's top or bottom end, be sure to make measurement compensation as described on the back of the detector.
- The detector should previously be positioned correctly on the plain rod according to the reference mark.

[Plain rod marking]

After the reference level has been detected, mark a line along the plain rod's top or bottom end.

[Reading the staff]

After the reference level has been detected, read the staff, using the index on the rod adapter.

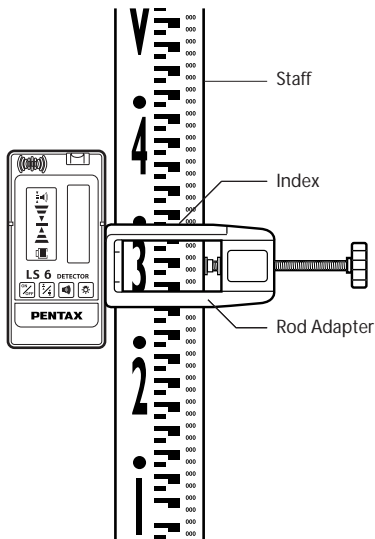

NOTE:

- When detecting the reference level, slightly loosen the fixing screw for the rod adapter and move the detector up and down along the staff.

5. Maintenance

5.1 Maintenance after use

[Stains on the main body]

- ① Brush dust off and wipe off moisture with tissue paper.
- ② Clean off any stains with a soft, dry cloth.
- ③ Excessive stains should be removed with a soft cloth soaked in a water diluted neutral detergent and squeezed dry.
Do not use benzene, thinner, gasoline or chemicals.



[Stains on the glass surface]

Brush dust off.

Gently wipe off stains with a silicone cloth or a cleaning cloth for eye glass lenses.

Excessive stains should be wiped off with soft cotton cloth impregnated with a cleaning liquid for eye glass lenses.

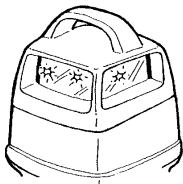

[Handling the battery]

If the instrument is not to be used for a long time, be sure to remove the batteries from the instrument and the detector and store them.



NOTE:

- Be sure not to use chemicals such as benzine, thinner or gasoline.
- Be careful not to scratch the glass surface.
- Leaving the batteries in the instrument for extended period may cause power consumption even if it is not in use.
- If used battery is left in the battery holder, the instrument of the detector may be damaged by the battery fluid leakage.

5.2 Check and adjustment of the datum point

[Check]

- ① Set up the instrument on the tripod halfway between two walls or pillars about 40m away so that the 'X side' of the instrument faces the 'Wall A' and level it.
- ② Operate the instrument and turn on the power to the detector. (use the detection accuracy initially set.)
- ③ Mark the reference point detected for both walls. (A,B)
- ④ Arrange a pair of target plates (with the same scale) and fix them to the walls (A and B) so that the center values of the target plates coincide with the reference point marks.
- ⑤ Loosen the center screw of the tripod to turn the instrument 180 for the 'X side' to face the 'Wall B' and tighten the center lock screw again for the instrument to be leveled again.

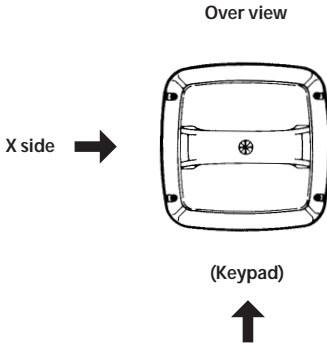

- ⑥ Read the target plates on the walls (A,B) to detect the reference points.
- ⑦ If the readings of the target plates differ less than ± 5 mm, the instrument needs not to be adjusted.
- ⑧ If more than ± 5 mm, proceed to the following (Adjustment) procedure.

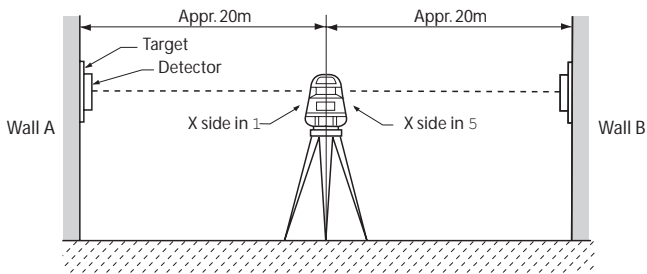

5.3 Troubleshooting

PLP-601 / PLP-602 / PLP-601R / PLP-602R

Rotor	Display	Content	Checking point
Does not rotate	Display lamps are not turned on.	① Battery capacity is low. ② Incorrect battery insertion.	① Replace with fresh batteries or charge battery ② Check the polarity of the batteries.
	Lamp ① turns on.	① Instrument's tilt exceeds auto leveling area. ($\pm 5.7^\circ$) ② Instrument is tilt largely by any cause. ③ After power supply turns on, unstable state of auto self-leveling function continues approx.3 min. NOTE*	① Turn off the power supply and reset the instrument level ($\pm 5.7^\circ$) and turn on again. ② Turn off the power supply and turn on again. ③ Turn off the power supply and turn on again.
	Lamp ① & lamp ② blink mutually	Defect of instrument itself.	Turn off the power supply and turn on again. If the lamps blink farther, instrument need to be repaired.

* NOTE:

- When the operation is continued, set the laser beam on the reference mark and perform it.

Manual mode display lamp: ②

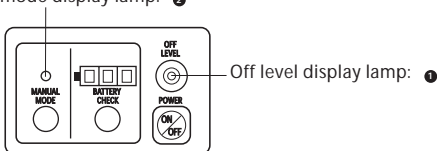

Detector LS6

Rotor	Display	Content	Checking point
Can rotate	Cannot detect	① Battery capacity is low. ② Incorrect battery insertion.	① Replace with fresh battery. ② Check the polarity of the batteries.
Can rotate	Battery indicator blinks	Battery capacity is low.	Replace with fresh battery.

NOTE:

- If the instrument is not returned to normal, even through these measures, connect your dealer or authorized shop.

6. Specifications

INSTRUMENT PLP-601R / PLP-602R

Accuracy of reference beam:	$\pm 10''$ (PLP-601/PLP-601R) $\pm 12''$ (PLP-602/PLP-602R)
Measuring range:	Radius 1~200m (PLP-601/PLP-601R) Radius 1~120m (PLP-602/PLP-602R)
Automatic self-leveling range:	$\pm 10\%$ ($\pm 5.7^\circ$)
Light source:	Visible Laser Diode (635nm Max 1.0mW)
Rotation speed:	300rpm / 600rpm (can be switched)
Operation power supply:	4 x D type batteries (PLP-601/ PLP-602) Rechargeable Ni-MH battery (PLP-601R/ PLP-602R)
Operation time:	24 hours on manganese battery (PLP-601/PLP-602) 48 hours on alkaline battery (PLP-601/PLP-602) 18 hours on Rechargeable Ni-MH battery (PLP-601R/PLP602R)
Charging time:	2 hours (PLP-601R/ PLP-602R)
Waterproof:	IPX6 Watertight type
Working temperature range:	-20°C ~+50°C (-4°F ~ +122°F)
Tripod attaching screw:	JIS/B type (5/8" x 11 thread)
Dimensions:	170w x 170D x 225H mm
Weight:	2.5kg (w/battery)

DETECTOR LS6

Detection Accuracy:	HIGH ± 1 mm LOW ± 2.5 mm
Beam reception indicator:	Liquid crystal display / buzzer
Sensitivity of vial:	30' / 2mm
Power supply voltage:	DC9V battery(6F22 or 6LF22)
Operation time:	Approx 40 hours on alkaline battery (6LF22)
Auto power off:	Power supply: Approx.10 min.
Illumination:	Approx.1 min
Dimensions:	140w x 68H x 25L mm / 200g

7. Notice to the user of this product

To assure compliance with the Safety Standard 21 CFR, Chapter I. Subchapter J. The U.S. bureau of Radiological Health requires the following information to be provided to the user:

1) Specifications of Laser Radiation.

- A. This laser system is designed and built to have a GaAlAs laser diode radiating at $635\text{nm} \pm 15\text{ nm}$.
- B. Radiant power
This laser product is designed and built to radiate a maximum average radiant power of $10\mu\text{ W}$ as scanning beam during functional operation. The user may be subject to this radiation as a scanned beam while the rotor is rotating until such time that the instrument is turned off.
 - For a period of less than 10 seconds during the operation the user may be subjected to this radiation.

2) The following labels are affixed to and must remain attached to this laser product.

- A. Certification Label
'This laser product conforms to the provisions of 21 CFR 1040.10 and 1040.11. For a class 2 laser product.'
Located on the surface of the base of top-handle.
- B. Caution Label
'Laser beam, do not look into the laser beam source directly.'
Located near to exit aperture, facing upward.

3) Caution to maintain the safety in compliance with the standard.

- To maintain the safety standard, refrain from any operation, maintenance or adjustment other than described in this instruction manual.
- Operation, maintenance or adjustment other than those specified in this instruction manual may result in hazardous radiation exposure.
- Maintenance and repair not covered in this manual must be done by an authorized Pentax dealer.

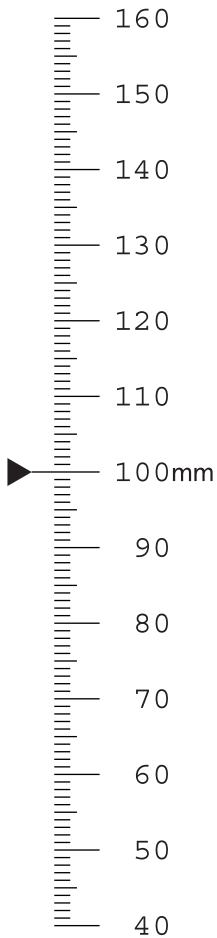

PENTAX

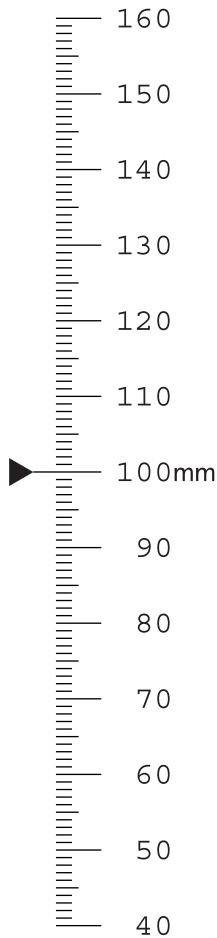

PENTAX

PENTAX Industrial Instruments Co., Ltd.
2-5-2 Higashi-Oizumi
Nerima-ku, Tokyo 178-0063, Japan
Tel. +81 3 5905 1222
Fax +81 3 5905 1225
E-mail: international@piic.pentax.co.jp
Website: www.pentax.co.jp/piic/survey

Printed in Belgium



for your
precious moments



The CE marking assures that this product complies with the requirements of the EC directive for safety.



JSIMA
Japan Surveying Instruments Manufacturers' Association

*Member symbol of the Japan
Surveying Instruments Manufacturers'
Association representing the high quality
surveying products.*

PENTAX®
Total Surveying Solutions

Free Manuals Download Website

<http://myh66.com>

<http://usermanuals.us>

<http://www.somanuals.com>

<http://www.4manuals.cc>

<http://www.manual-lib.com>

<http://www.404manual.com>

<http://www.luxmanual.com>

<http://aubethermostatmanual.com>

Golf course search by state

<http://golfingnear.com>

Email search by domain

<http://emailbydomain.com>

Auto manuals search

<http://auto.somanuals.com>

TV manuals search

<http://tv.somanuals.com>