

PENTAX™

Digital Camera

Optio33WR

Operating Manual

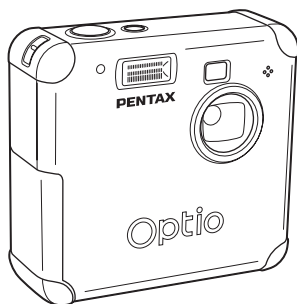

To ensure the best performance from your camera, please read the Operating Manual before using the camera.

Thank you for buying the PENTAX Optio 33WR Digital Camera. Please read this manual before using the camera in order to get the most out of all the features and functions. Keep this manual safe, as it can be a valuable tool in helping you to understand all the camera's capabilities.

Regarding copyrights

Images taken using the Optio 33WR that are for anything other than personal enjoyment cannot be used without permission according to the rights as specified in the Copyright Act. Please take care, as there are even cases where limitations are placed on taking pictures even for personal enjoyment during demonstrations, industrial enterprise or as items for display. Images taken with the purpose of obtaining copyrights also cannot be used outside the scope of use of the copyright as laid out in the Copyright Act, and care should be taken here also.

Regarding trademarks

-  SD logo is a trademark.
- PENTAX is a trademark of PENTAX Corporation.
- Optio is a trademark of PENTAX Corporation.
- All other brands or product names are trademarks of registered trademarks of their respective companies.
- This product supports PRINT Image Matching II.

When used in combination, PRINT Image Matching II enabled digital still cameras, printers and software help photographers to produce images more faithful to their intentions.

Copyright© 2001 Seiko Epson Corporation. All Rights Reserved.

PRINT Image Matching is a trademark of Seiko Epson Corporation.

To users of this camera

- There is a possibility that recorded data may be erased or that the camera may not function correctly when used in surroundings such as installations generating strong electromagnetic radiation or magnetic fields.
- The liquid crystal panel used in the LCD display is manufactured using extremely high precision technology. Although the level of functioning pixels is 99.99% or better, you should be aware that 0.01% or fewer of the pixels may not illuminate or may illuminate when they should not. However, this has no effect on the recorded image.
- There is a possibility that the illustrations and the display screen of the LCD monitor in this manual are different from the actual product.

FOR YOUR SAFETY

We have paid close attention to the safety of this product. When using this product, we request your special attention regarding items marked with the following symbols.



Warning This symbol indicates that violating this item could cause serious personal injury.



Caution This symbol indicates that violating this item could cause minor or medium personal injury, or material loss.



Warning

- Do not disassemble or modify the camera. High voltage areas are present inside the camera, with the risk of electric shock.
- If the camera interior is exposed due to dropping or otherwise damaging the camera, never touch the exposed portion. There is the risk of electric shock.
- Wrapping the strap around your neck is dangerous. Take care that small children do not hang the strap over their necks.
- To avoid the risk of it being swallowed by mistake, keep the SD Memory Card / MultiMediaCard out of the reach of small children. Seek medical attention immediately if accidentally swallowed.
- Always use the AC adapter specified exclusively for this product, with the specified power and voltage. Using an AC adapter not exclusive to this product, or using the exclusive AC adapter with an unspecified power or voltage can cause a fire, electric shock, or camera breakdown.
- If any irregularities occur during use, such as smoke or a strange odor, stop use immediately, remove the batteries or the AC adapter, and contact your nearest PENTAX service center. Continued use could cause a fire or electric shock.
- During thunderstorms, unplug and discontinue use of the AC adapter. Continued use could cause equipment failure, a fire, or electric shock.



Caution

- Do not short the battery or dispose of the battery in fire. Do not disassemble the battery. The battery could explode or catch fire.
- Do not charge any batteries other than rechargeable Ni-MH batteries. The battery could explode or catch fire. Of the batteries that can be used in this camera, only the Ni-MH battery can be recharged.
- Remove the battery from the camera immediately if it becomes hot or begins to smoke. Be careful not to burn yourself during removal.
- Some portions of the camera heat up during use. There is the risk of low temperature burns when holding such portions for long periods.
- Do not place your finger on the flash when it is discharging as there is a risk of burns.

Handling the Camera

- Always confirm that the camera is working properly when the camera has not been used for a long time, or before important occasions (weddings, trips, etc.). PENTAX is not responsible for consequential damages (costs incurred for photography, lost profits, etc.) arising from failure of this product.
- The lens on this camera is not exchangeable. The lens is not removable.
- Do not clean the product with organic solvents such as thinner, alcohol, or benzene.
- Do not subject to high temperatures or high humidity. Do not leave the camera in a vehicle, as the temperature can get very high.
- Do not store the camera with preservatives and chemicals. Storage in high temperatures and high humidity can cause molding. Remove from case and store in a dry and well-ventilated location.
- Do not subject the camera to strong vibrations, shocks, or pressure. Use a cushion to protect the camera from vibrations of motorcycles, automobiles, or ships.
- The temperature range for camera use is 0°C to 40°C.
- The LCD display may appear black under high temperatures, but will return to normal as temperatures normalize.
- The LCD display may respond more slowly at low temperatures. This is due to liquid crystal properties, and is not a fault.
- Periodic inspections are recommended every one to two years to maintain high performance.
- Sudden temperature changes will cause condensation on the inside and outside of the camera. Place the camera in your bag or a plastic bag, retrieving the camera after decreasing the temperature difference.
- Avoid contact with garbage, mud, sand, dust, water, toxic gases, or salts. These could cause a camera breakdown. Wipe dry any rain or water drops on the camera.
- See "Precautions when using an SD Memory Card / MultiMediaCard" (p.18) for details on the SD Memory Card / MultiMediaCard.
- Please do not press forcefully on the LCD monitor. This could cause breakage or malfunction.

Water-resistant Feature

- This camera conforms to JIS, (Japanese Industrial Standard) Class 5 water resistant, (Direct jetting water under defined conditions shall have no harmful effect) and Class 7 water resistant, (Water shall not enter the enclosure when it is immersed in water up to 30 minutes at a depth of 1 meter.)
- This camera cannot be used underwater.
- Immediately after using the camera, be sure to carefully wipe off any water or dirt with a soft, dry cloth.
- Do not place the camera directly on the sand at a beach or other location. Exposure to large amounts of sand or dirt may damage the camera.
- The inside of the camera is not water resistant. Before using the camera, be sure the terminal cover and battery/card cover are securely closed.
When replacing the battery or inserting or removing the memory card, carefully wipe off any water or dirt and open the cover in a location where the camera is not exposed to water or dirt. If water, sand, or dirt gets inside the camera, the camera may become damaged.
- If the camera becomes exposed to large amounts of dirt or salt water, make sure that the power is off and the terminal cover and battery/card cover are securely closed, and then carefully rinse off the camera under slowly running tap water or in a shallow basin filled with fresh water for two to three minutes.
- This camera should not be immersed in water for periods longer than thirty minutes at a time or exposed to extreme water pressure.
- Do not clean the camera with soapy water, mild detergent, or alcohol as this may reduce the effectiveness of the camera's water-resistant feature. Be careful not to expose the camera to coffee or other beverages, as this may also reduce the effectiveness of the camera's water-resistant feature.
- Before using the camera, be sure to wipe off any sand or debris from the water-resistant packing and the areas between the camera and the packing. Any scratches or damage to the packing or the areas between the camera and the packing or any peeling of the packing may reduce the effectiveness of the camera's water-resistant feature. If this should occur, please call the Pentax Customer Service Department.
- The accessories of SD card, battery, USB cable and AV cable are not water resistant.

CONTENTS

FOR YOUR SAFETY.....	1
Handling the Camera.....	2
Water-resistant Feature.....	3
CONTENTS.....	4
Contents of This Manual.....	7
Checking Package Contents.....	8
Names of Parts.....	9
Names of Operating Parts.....	10
Getting Started	11
Attaching the Strap.....	11
Powering the Camera.....	12
Installing the Batteries.....	12
Using the AC Adapter.....	15
Installing / Removing the SD Memory Card / MultiMediaCard.....	16
Turning the Camera On and Off.....	19
Initial Settings.....	20
Setting the Display Language.....	20
Setting the Home Town.....	21
Setting the D.S.T. Mode.....	21
Setting the Video Output Format.....	22
Setting the Date and Time.....	22
Quick Start	24
Taking Still Pictures.....	24
Playing Back Still Pictures.....	26
Playing Back Images.....	26
Playing Back Previous or Next Images.....	26
Using an SD Memory Card / MultiMediaCard.....	28
Common Operations	30
Using the Button Functions.....	30
Capture Mode.....	30
Playback Mode.....	31
Setting the Menu.....	32
How to Set the Menus.....	32
Menu List.....	34
Taking Pictures	36
Setting the Capture Functions.....	36
Changing the Mode.....	36
Changing Focus Settings.....	37
Selecting the Flash Mode.....	39
Selecting the Recorded Pixels.....	40

Selecting the Quality Level	41
Adjusting the White Balance	42
Setting the Focusing Area	44
Setting the Light Metering Range	45
Setting Sensitivity	46
Setting Image Sharpness	47
Setting Color Saturation	48
Setting the Image Contrast	49
Taking Pictures	50
Program Mode	50
Picture Mode	51
Taking Panorama Pictures (Panorama Assist Mode)	53
Using the Self-Timer	55
Continuous Shooting (Continuous Shooting/Multi Continuous Shooting)	56
Taking Pictures at Fixed Intervals (Interval Shoot)	57
Using the Zoom	59
Recording Sound (Voice Recording Mode)	61
EV Compensation	62
Taking Movie Pictures (Movie Picture Mode)	63
Changing the Recorded Pixels Setting When Taking Movie Pictures	65
Changing the Color Mode Setting When Taking Movie Pictures	66
Taking Fast Forward Movie Pictures (Fast Fwd Movie)	67
Saving the Settings	68
Saving the Menu Items (Memory)	68
Playback/Deleting	70
<hr/>	
Playing Back Images	70
Playing Back Still Pictures	70
Zoom Display	70
Nine-image Display	71
Using Slideshow for Continuous Playback	72
Playing Back Movie Pictures	73
Adding a Voice Memo	74
Recording a Voice Message	75
Playing Back Sound	76
Deleting Images	77
Deleting an Image	77
Deleting All Images	79
Protecting Images from Deletion (Protect)	80
Viewing Images on a TV	81
Setting the Printing Service (DPOF)	82
Printing Individual Image	82
Printing All Images	84

Editing Images	85
Changing the Image Size	85
Trimming Images	87
Editing Images with Digital Filters	88
Camera Settings	90
Formatting an SD Memory Card / MultiMediaCard	90
Changing the Sound Settings.....	91
Changing the Date Style and Date / Time	92
Setting World Time	93
Changing the Display Language	94
Setting the Display Mode.....	95
Changing the Start-up Screen	97
Setting the Background Color.....	98
Selecting the Video Output Format	99
Setting Auto Power Off	99
Resetting to Default Settings [Reset].....	99
Setting the Alarm	100
Checking the Alarm	100
Setting the Alarm	101
Turning the Alarm Off	102
Appendix	103
List of City Names	103
Messages	104
Optional Accessories	105
Troubleshooting	106
Main Specifications	108
WARRANTY POLICY	110

Contents of This Manual

This operating manual contains the following chapters.

1 Getting Started

Explains your first steps, from purchasing the camera to taking pictures. Be sure to read it and follow the instructions.

2 Quick Start

Explains the simplest way to take pictures and play back images. Use it if you want to get started right away. It also explains how to use an SD Memory Card and MultiMediaCard.

3 Common Operations

Explains common operations such as button functions and using the menus. See "Taking Pictures", "Playback/Deleting", and "Settings" chapters for more details.

4 Taking Pictures

Explains various ways to capture images, and how to set the relevant functions, such as setting the virtual mode dial to change capture modes, and selecting the right picture mode for the current scene.

5 Playback/Deleting

Explains how to play back images on the camera or a TV, and how to delete.





6 Editing/Settings

Explains how to edit images and set up the functions of the camera.

7 Appendix

Explains troubleshooting, and introduces accessories sold separately.

The symbols used in this operating manual are explained below.

	Shows reference page number explaining a related operation.
	Shows information useful to know.
	Shows precautions to take when operating the camera.
P Picture Mode 	Icons for functions available in a capture mode are shown at the beginning of a section.

Checking Package Contents



Camera
Optio 33WR

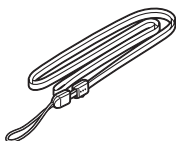

Strap
O-ST5 (*)

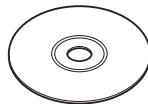

Software
(CD-ROM) S-SW13

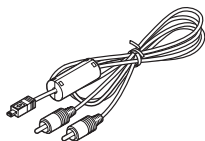

AV cable
I-AVC7 (*)

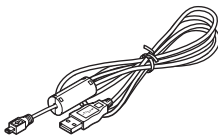

USB cable
I-USB7 (*)



AA Alkaline batteries (2)



SD Memory Card
(16 MB)



Operating Manual
(this manual)



Operating Manual
(PC Connection Manual)

(*) Items marked with an asterisk are also available as optional accessories. For other optional accessories, see "Optional Accessories" (p.105) .

Names of Parts

Front view

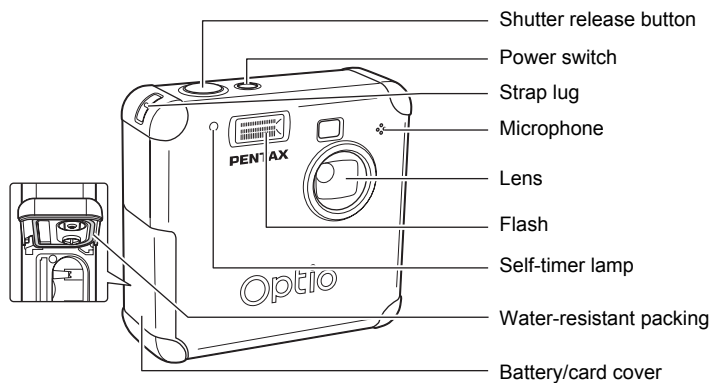

Back view

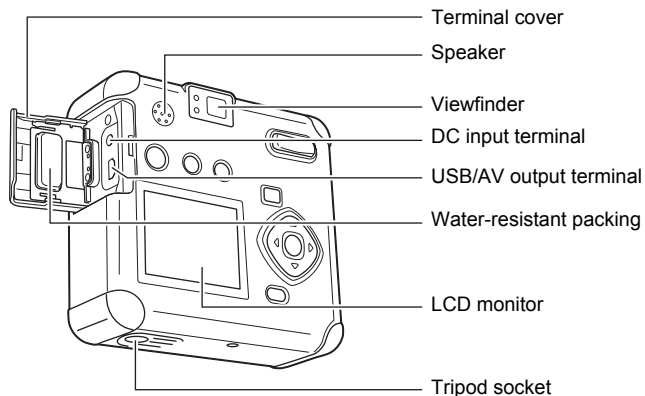

Names of Operating Parts

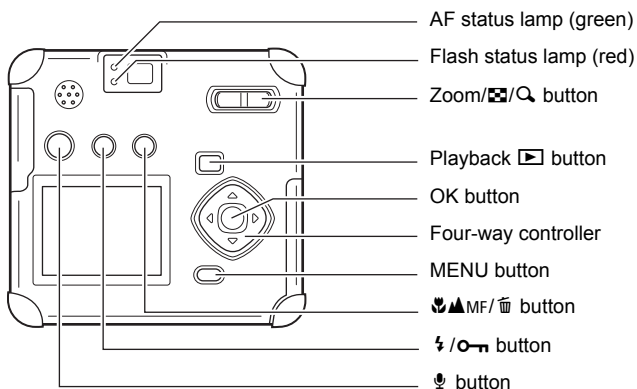

Guide display

A button operation guide is displayed on the LCD monitor during operation.

The buttons are indicated as shown below.

Four-way controller (▲)	▲	Zoom/□/Q button	
Four-way controller (▼)	▼	(Digital zoom and magnified playback only)	Q
Four-way controller (◀)	◀	button	
Four-way controller (▶)	▶	button	
MENU button	(MENU)	button	
Shutter release button	(SHUTTER)	OK button	OK

Attaching the Strap

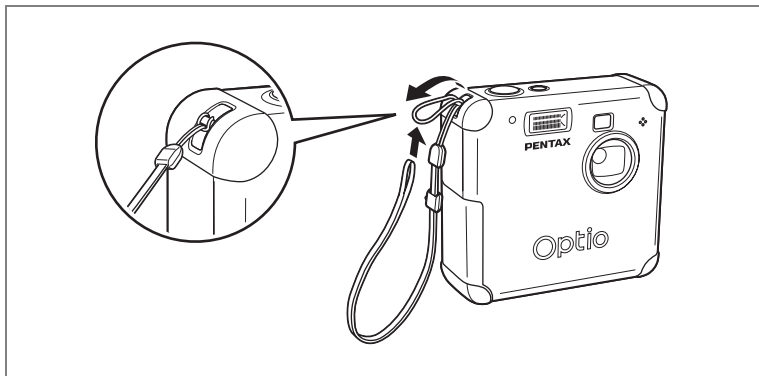

Pass the narrow end of the strap through the strap lug, and attach as shown.

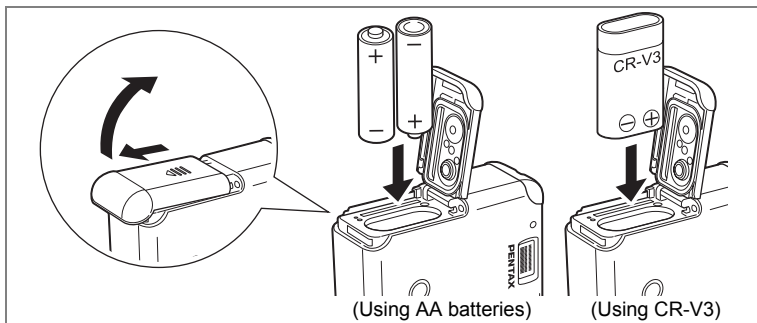

Installing the Batteries

Install batteries in the camera. Use one CR-V3, or use two AA lithium batteries, AA Ni-MH batteries, or AA alkaline batteries.

Turn off the camera when setting batteries.

Wipe away water or dirt from the camera with a dry cloth before setting batteries.

Do not set batteries with wet or dirty hands.

- 1** Slide the battery cover in the direction of the arrow , and flip open.
- 2** Insert the batteries according to the $\oplus \ominus$ indicator in the battery chamber.
- 3** Wipe away any sand or debris on the water-resistant packing and the areas between the camera and the packing.
- 4** Close the battery cover and push horizontally to lock.



When using for a prolonged period, please use the AC adapter D-AC5 (p.15).



- AA lithium, AA alkaline battery, and the CR-V3 battery are not rechargeable.
- Do not open the battery cover or remove the batteries when the power switch is on.
- When you will not use the camera for a long while, remove the batteries. Otherwise, the battery may leak.
- If the date and time settings have been reset when you insert new batteries after a long while, follow the procedure for “Setting the Date and Time” (p.22).
- Insert batteries correctly. Wrong insertion can cause a camera breakdown.

Number of Captures and Playback Time (room temperature, new batteries)

• Taking pictures (50% flash usage)

	Image Storage Capacity
CR-V3	Approx. 540
AA lithium batteries	Approx. 360
Ni-MH batteries	Approx. 300
AA alkaline batteries	Approx. 125

• Playback

	Playback time
CR-V3	Approx. 230 min.
AA lithium batteries	Approx. 160 min.
Ni-MH batteries	Approx. 125 min.
AA alkaline batteries	Approx. 75 min.

- These figures are based on PENTAX measuring conditions. They may vary by capture mode or shooting conditions.



- Battery performance temporarily decreases as the temperature decreases. When using the camera in cold climates, have extra batteries on hand, keeping them warm in your pocket. Battery performance will return to normal when returned to room temperature.
- When traveling overseas, taking pictures in cold climates, or when you will be taking a lot of pictures, please have extra batteries ready.

Battery Level Indicator

You can check the battery level with the  display on the LCD monitor.

1

Getting Started

 (lit green) : Adequate power remains.



 (lit green) : Battery is running low.



 (lit yellow) : Battery is running very low.



 (lit red) : Battery is exhausted.



No battery power : After displaying this message, the camera turns off.

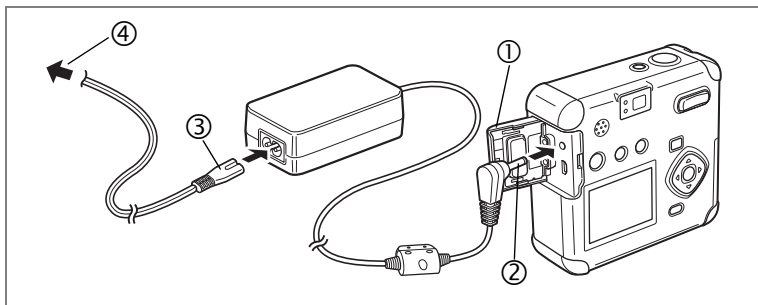

Using the AC Adapter

When using the LCD monitor for a long time or when connecting to your PC, we recommend using the AC adapter D-AC5 (sold separately).

- 1 Make sure the camera is turned off before opening the terminal cover.**
- 2 Connect the DC terminal on the AC adapter to the DC input terminal on the camera.**
- 3 Connect the AC plug cord to the AC adapter.**
- 4 Plug the AC plug cord into the power outlet.**



- Make sure the camera is turned off before connecting or disconnecting the AC adapter.
- Make sure connections are secure between the camera, AC adapter, AC plug cord terminal, and the power outlet. Disconnections while the camera is recording or reading data will corrupt your data.
- When using the AC adapter, be sure to read the AC adapter D-AC5 operating manual.
- Connecting the AC adapter will not charge the rechargeable batteries in your camera.

Installing / Removing the SD Memory Card / MultiMediaCard

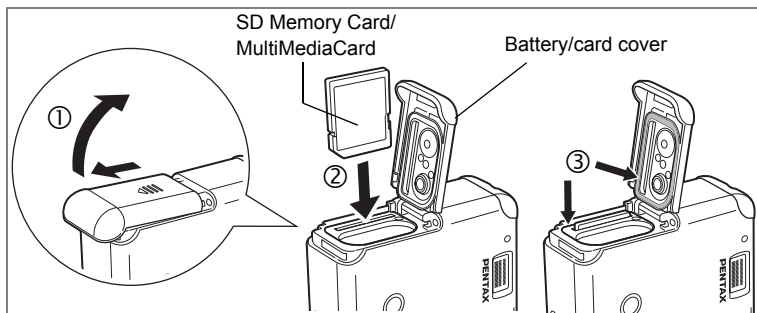

The image or recorded audio is recorded on the SD Memory Card / MultiMediaCard. Be sure the camera is turned off before inserting or removing the SD Memory Card / MultiMediaCard.

Turn off the camera before setting or removing the card.



Wipe away water or dirt from the camera with a dry cloth before setting or removing the card.

Do not set or remove the card with wet or dirty hands.

Installing

- 1** Slide the battery/card cover to the direction of the arrow , and flip open.
- 2** With the label (or ▲ symbol) of the SD Memory Card / MultiMediaCard toward the lens, insert the card into the card slot until the card clicks. If the card is not inserted properly, images and sound may not be recorded correctly.
- 3** Wipe away any sand or debris on the water-resistant packing and the areas between the camera and the packing.
- 4** Close the battery/card cover.

Removing

- 1** Slide the battery/card cover in the direction of the arrow , and flip open.
- 2** Press the SD Memory Card / MultiMediaCard in the direction of the arrow , then pull out the ejected card.
- 3** Wipe away any sand or debris on the water-resistant packing and the areas between the camera and the packing.
- 4** Close the battery/card cover.

Caution: • If the battery/card cover is opened while saving an image, the save is interrupted (the image is not saved).

Approximate Number of Shots, Recorded Pixels, and Quality Levels

Quality level Recorded Pixels	Best/★★★	Better/★★	Good/★	Movie picture (320×240)	Movie picture (160×120)	Voice recording
2048×1536	7	12	18	40 sec.	150 sec.	30 min.
1600×1200	11	20	27			
1024×768	25	45	56			
640×480	53	82	100			

- These figures show the number of shots when using a 16MB SD Memory Card.
- These figures are based on PENTAX standard shooting conditions, and may vary depending on the subject, shooting conditions, capture mode, and SD Memory Card used.

• Precautions when using an SD Memory Card / MultiMediaCard

- Make sure the camera is turned off before opening the battery/card cover.
- The SD Memory Card has a write-protect switch. Moving the switch to the [Lock] position prevents the recording and erasing of data and the formatting of the card and protects all saved data.
- SD Memory Cards/MultiMedia Cards formatted on a PC or device other than the camera cannot be used. Be sure to format the card with the camera.
- The SD Memory Card / MultiMediaCard may be hot when removed immediately after camera use. Please be careful.
- Do not remove the card or turn off the camera when recording data or playing back images or audio from the SD Memory Card / MultiMediaCard, or when connected to a PC with the USB cable. This could cause data loss or card damage.
- Do not bend the SD Memory Card / MultiMediaCard or subject it to violent impact. Do not get it wet or leave it in a high temperature location.
- New cards or cards used in another camera must be formatted before use. For more information about formatting the card, see "Formatting an SD Memory Card / MultiMediaCard" (p.90).
- Do not remove the SD Memory Card / MultiMediaCard while the card is being formatted. The card may be damaged and become unusable.
- Data stored on an SD Memory Card / MultiMediaCard may be erased under the following conditions. PENTAX does not accept any liability regarding erased data.
 - When the user mishandles the SD Memory Card / MultiMediaCard
 - When the SD Memory Card / MultiMediaCard is placed in a location with static electricity or electrical interference
 - When the card is not used for a long time
 - When the card, the AC adapter, or battery is removed while recording or reading data on the SD Memory Card / MultiMediaCard
- The SD Memory Card / MultiMediaCard has a finite operating life. The stored data may become unreadable after long periods of disuse. Please periodically backup important data onto your PC.
- Please avoid using or storing your card where static electricity or electrical interference can occur.
- Do not use or store your card where it may be exposed to sudden temperature changes, condensation, or direct sunlight.

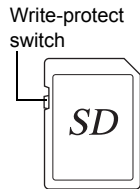

Turning the Camera On and Off

1

Getting Started

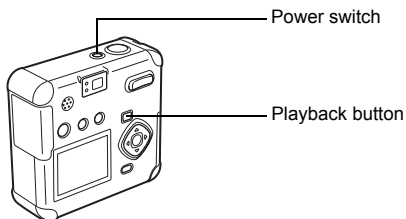



1 Press the power switch.

The camera will turn on.

Press the power switch again to turn the camera off.

Card check feature

When the camera is turned on, the camera automatically checks for a card. If there is no SD Memory Card / MultiMediaCard inside the camera,  appears on the LCD monitor.

If the write protect switch is set to LOC,  appears on the LCD monitor, indicating that images and audio cannot be recorded.

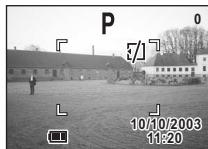

Initial Settings

1

Getting Started

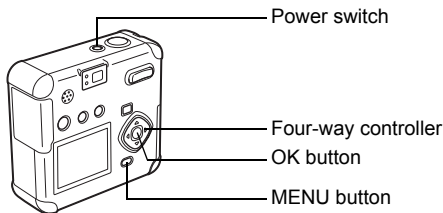

If the initial settings screen appears when you turn the camera on, follow the procedure below to set the display language, Home Town, DST, video output format and current date and time. If the date and time that appear at the bottom right of the LCD monitor when you turn the camera on for the first time is not the current time, follow the instructions for “Changing the Date Style and Date / Time” (p.92) to set the correct date and time.

Once the above Initial Settings are performed, the Initial Setting screens do not appear on your LCD monitor again.

Setting the Display Language

You can choose the language in which the menus, error messages, etc. are displayed from the following: English, French, German, Spanish, Italian, Russian, Chinese and Japanese.

- 1 Turn the camera on.**
- 2 Use the four-way controller (◀▶) to select the display language.**

The default setting is English.

- 3 Press the four-way controller (▼).**

The screen for setting the City will be displayed.

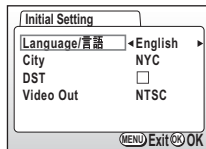

You can change the setting after it has been made. Refer to “Changing the Display Language” (p.94).

Setting the Home Town

You can choose the city (Home Town) in which you will use the camera.

- 1 **Press the four-way controller (◀▶) to select the desired city (Home Town).**

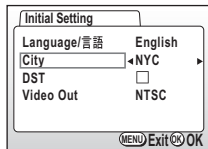

- 2 **Press the four-way controller (▼).**

The screen for setting the D.S.T. will be displayed.



- See p.103 for the list of cities and corresponding code names.
- You can change the setting after it has been made. Refer to “Setting World Time” (p.93).

Setting the D.S.T. Mode

You can choose whether or not to display the D.S.T (Daylight Saving Time) mode.

- 1 **Use the four-way controller (◀▶) to select (on) or (Off).**

The default setting is (Off).

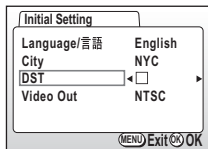

- 2 **Press the four-way controller (▼).**

The screen for setting the next item will be displayed.



- You can change the setting after it has been made. Refer to “Setting World Time” (p.93).

Setting the Video Output Format

You can choose the output format (NTSC or PAL) for taking or playing back pictures using a TV monitor.

- 1 Use the four-way controller (◀▶) to select the video output format.**

The default setting is NTSC.

- 2 Press the OK button.**

The screen for setting the date and time will be displayed.

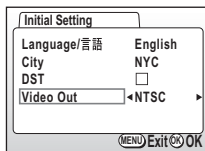

You can change the setting after it has been made. Refer to “Selecting the Video Output Format” (p.99).

Setting the Date and Time

Set the current date and time, and the display style.

- 1 Press the four-way controller (▲▼) to select the date and time display style.**

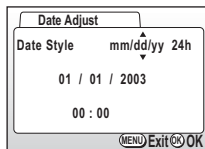

- 2 Press the four-way controller (▶).**
▲▼ are displayed above and below “24h”.

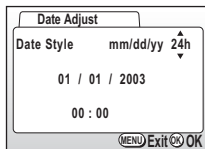

- 3 Press the four-way controller (▲▼) to select 24h (24-hour display) or 12h (12-hour display).**

4 Press the four-way controller (▶).

▲▼ is displayed above and below the month.

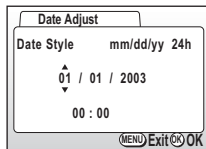

5 Press the four-way controller (▲▼) to change the month.

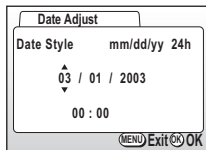

6 Press the four-way controller (▶).

▲▼ are displayed above and below the date.

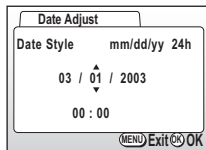

7 Press the four-way controller (▲▼) to set the date and press the four-way controller (▶) again.

▲▼ are displayed above and below the year.

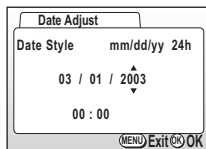

8 Repeat step 7 to set the year, hour, and minutes.

9 Press the OK button.

The camera is ready to take a picture. When you set the date and time using the MENU button, you will return to the Menu screen. Press the Playback/OK button again.



- If you press the MENU button before initial settings are complete, your settings will be cancelled, but you can take pictures. If this happens, the Initial Settings screen is displayed the next time the camera is turned on.
- Your settings can be changed later from the Menu screen. To access the menu, see "Changing the Date Style and Date / Time" (p.92).

Taking Still Pictures

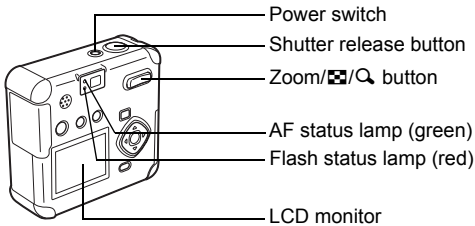

This is the simplest way to take still pictures. The flash discharges automatically based on light conditions by the default setting.

1 Press the power switch.

The camera will turn on.

2 Confirm the subject and shooting information on the LCD monitor.

The focus frame at the center of the LCD screen indicates the zone of automatic focusing. Press the Zoom button to change the size of the subject.

▲ Subject becomes bigger.

▲▲▲ Subject becomes smaller.

You can check the size of the subject by looking through the viewfinder.

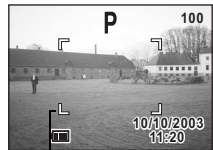

Focus frame

3 Press the shutter release button.

The image will be displayed on the LCD monitor for 1.5 seconds (Instant Review) and recorded on the SD Memory Card / MultiMediaCard. (The green and red lamps next to the viewfinder blink alternately while the image is being recorded on the SD Memory Card / MultiMediaCard.)

Pressing the Shutter Release Button

The shutter release button works in two steps.

• Press halfway

Lightly press (halfway) the shutter release button to lock the focus position, exposure, and white balance.

The shutter speed and aperture settings are only displayed when pressing the shutter release button halfway.

You can find the following information on the LCD monitor, the AF status lamp and the flash status lamp.

1. Focus frame

The frame lights green when focused. It is not displayed when out of focus.

2. Focus status lamp & Flash status lamp

	AF status lamp (green)	Flash status lamp (red)
Lit	Subject is in focus.	Flash is ready.
Blink	Subject is out of focus.	Now charging.

You cannot take a picture while the flash is charging.

• Press down fully

Press the shutter release button all the way down (fully) to take a picture.

• Poor focusing conditions

The camera may not focus if the subject is in a condition shown below. Lock the focus on something that is the same distance away as the subject (press the shutter release button halfway), and press the shutter release button fully when you have composed your picture.

- Things that lack contrast such as a blue sky or white wall.
- Dark places or objects, and conditions that prevent light being reflected back.
- Horizontal lines or intricate patterns
- Fast moving objects
- When an object in the foreground and one in the background are in the same picture.
- Strongly reflected light or strong backlighting (bright background)

Instant Review

Instant Review displays the image for 1.5 seconds. Pressing the  button during Instant Review displays the Delete menu. Select [Delete] and press the OK button to delete the image.

Playing Back Still Pictures

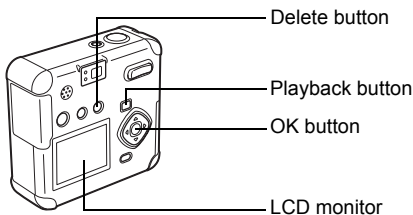

Playing Back Images

To play back still pictures:

- 1 Press the playback button after taking a picture.**

The captured image is displayed on the LCD monitor.



Playing Back Previous or Next Images

You can play back still pictures, cycling through one at a time.

- 1 Press the Playback button after taking a picture.**

The captured image is displayed on the LCD monitor.

- 2 Press the four-way controller (◀▶).**



Displays the previous image.



Displays the next image.

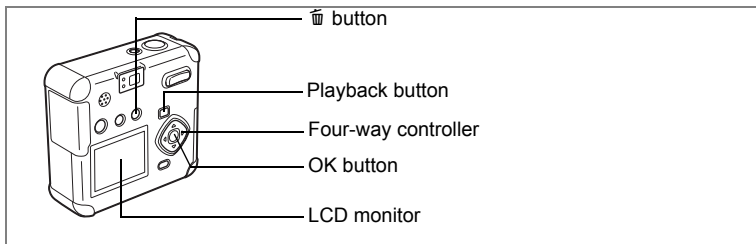

Deleting a Displayed Image

While the image is displayed, press the button to display the Delete screen. Press the four-way controller () to select Delete, and press OK. The image is deleted.

Press the shutter release button halfway or fully to prepare the camera to take another picture.



- When you switch to the playback screen, the image with the highest file number is shown first.
- You can enlarge the image displayed on the LCD monitor by pressing the zoom//Q button.

Zoom Playback p.70



- For movie pictures, the first frame is displayed.
- If no images are stored, the “No Image & sound” message is displayed.

Using an SD Memory Card / MultiMediaCard

Images taken with the camera are recorded on the SD Memory Card / MultiMediaCard. You can use the camera to view the images recorded on the card, transfer the images to your PC, and print them out.



Viewing images on the camera

One advantage of a digital camera is that you can check the picture as soon as you take it. You can check the composition and brightness, and take a picture again if you are not satisfied.

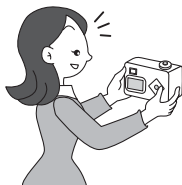

Playing Back Still Pictures  p.70

Viewing Images on a TV

Displaying your pictures on a TV is handy for those group occasions. To view images on your TV, connect the camera to the TV with the AV cable.

Viewing Images on a TV  p.81



Viewing Images on a PC

You can view recorded images and edit them on the PC just by connecting the camera to the PC with the USB cable and downloading the images (you need to install the USB driver if you are using Windows 98). You can also remove the SD Memory Card / MultiMediaCard from the camera and transfer the data with a card reader. On a laptop, you can put a SD Memory Card / MultiMediaCard in a card adapter and insert it into your card slot to transfer the image data. (When using other equipment to transfer your images from your SD Memory Card / MultiMediaCard, please read the operating manual for your equipment.)

☞ Reference [PC Connection Manual]



Printing Images at a Printing Service

Prints of images recorded on the SD Memory Card / MultiMediaCard can be ordered in the same way as with conventional photographs by taking the SD Memory Card / MultiMediaCard to a store that performs printing. DPOF (Digital Print Order Format) settings allow you to specify the number of copies or to include the date. Set these before taking your card to a store providing DPOF printing.

☞ Setting the Printing Service (DPOF) ☞ p.82

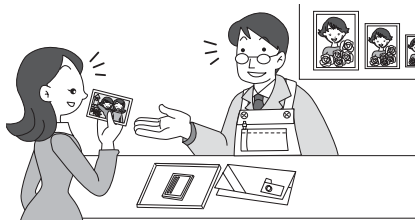

Using the Button Functions

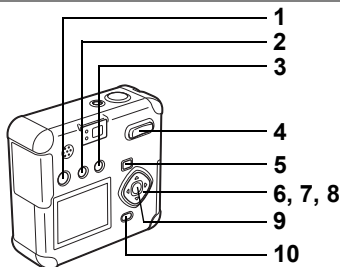

Capture Mode

The Button functions of Capture Mode are as follows, and this mode is switched to Playback Mode by pressing Playback button.

- 1** **🎤 button**
Switches to voice recording mode. (☞p.61)
- 2** **⚡ button**
Changes the flash mode. (☞p.39)
- 3** **🌱▲MF button**
Changes the focus mode as follows. (☞p.37)
Macro mode (☞p.37), Infinity-landscape mode (☞p.37),
Manual focus mode (☞p.37)
- 4** **Zoom button**
Changes the size of the subject on the LCD monitor or viewfinder. (☞p.59)
- 5** **Playback button**
Switches to Playback mode. (☞p.36)
- 6** **Four-way controller (◀▶)**
Changes the EV compensation. (☞p.62)
- 7** **Four-way controller (▲)**
Selects continuous shooting mode or self-timer mode. (☞p.56, 55)
- 8** **Four-way controller (▼)**
Displays the virtual mode dial and changes the capture mode. (☞p.36)
- 9** **OK button**
Selects a menu item.
- 10** **MENU button**
Displays [Rec.Mode] menu. (☞p.32)

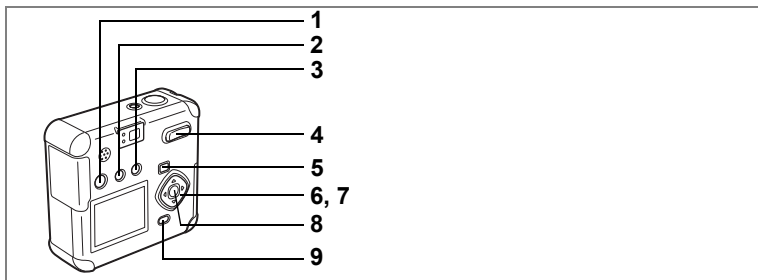

Playback Mode

The Button functions of Playback Mode are as follows, and this mode is switched to Capture Mode by pressing Playback button or the shutter release button halfway.

- 1** **Microphone button**
A voice memo is added to the image. (p.74)
The voice memo can be set as a voice message. (p.75)
- 2** **Key button**
Protects the image from deletion. (p.80)
- 3** **Trash button**
Deletes the image. (p.77)
- 4** **Zoom/9/Zoom button**
Press 9 in Normal Playback mode to display nine images at once. (p.71)
Press Zoom in Normal Playback mode to change the size of the Zoom Display image displayed on the LCD monitor. (p.70)
- 5** **Playback button**
Switches to Capture mode.
- 6** **Four-way controller (Left/Right)**
Plays back previous or next image. (p.26)
- 7** **Four-way controller (Up)**
Sets DPOF settings. (p.82)
- 8** **OK button**
Saves the function selected by the menu item. (p.32)
When pressed in Zoom Display or Nine-image Display mode, changes to Normal Playback mode. (p.70-71)
- 9** **MENU button**
Displays Playback menu. (p.32)

Setting the Menu

Press the MENU button to display the menus on the LCD screen. With these you can set functions, save the settings, and change the camera settings.

How to Set the Menus

A button operation guide is displayed on the LCD monitor during menu operation.

3

1 Press the MENU button.

The menu screen is displayed. The current selection is displayed in a frame.

2 Press the four-way controller (◀▶).

Use the four-way controller (◀▶) to select the menu screen.

3 Press the four-way controller (▲▼) to select an item.

Press the four-way controller (▲▼) to moves the selection frame up and down.

4 Press the four-way controller (◀▶) to change the setting.

Press the four-way controller (▶) to move to a Select screen if available.

When finished, press the OK button to return to the menu.

5 Press the OK button.

This saves the settings and returns to Capture or Playback mode.



- If you press any buttons except the OK button before press the OK button and leave the menu screen, any changes to setting will not be saved.
- Even after you press the OK button and close the menu screen, if the camera is turned off improperly (such as removing the batteries while the camera is on), your settings will not be saved.

Example of menu operation (Pressing the MENU button in Capture mode)

1 MENU button



2

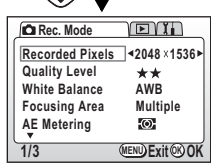

3

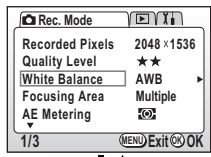

4 Selection Screen

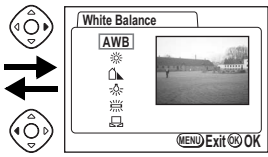

3

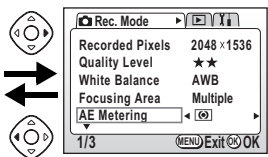
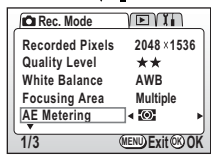

3

Next menu screen



- If you press the shutter release button halfway and move the camera to Capture mode, any changes to the setting will not be saved.
- When you display the menu from Capture mode, the [Rec.Mode] menu will be displayed, and when you display the menu from Playback mode, the [Playback] menu will be displayed.

Menu List

[📷 Rec.Mode] Menu

Item	Description	Reference
Recorded Pixels	Selects the number of recorded pixels.	p.40
Quality level	Selects the image compression rate.	p.41
White Balance	Adjusts color balance according to lighting.	p.42
Focusing Area	Changes the area for autofocus.	p.44
AE Metering	Sets the metering method to determine exposure.	p.45
Sensitivity	Sets sensitivity.	p.46
Digital Zoom	Takes digital zoom pictures.	p.60
Interval Shoot	Takes pictures at a specified interval of time.	p.57
Movie	Sets the recorded pixels of the movie picture, color mode, and Fast Fwd Movie.	p.63
Memory	Saves the Rec. Mode settings when the camera is turned off.	p.68
Sharpness	Sets the sharpness.	p.47
Saturation	Sets the saturation.	p.48
Contrast	Sets the contrast.	p.49

[▶️ Playback] Menu

Item	Description	Reference
Playback Message	Records a voice message.	p.75
Digital Filter	Sets the digital filter.	p.88
Resize	Changes the image size.	p.85
Trimming	Trims images.	p.87
Alarm	Sets the alarm to ring at a specified time.	p.100
Slideshow	Plays recorded images successively.	p.72

[Yi Set-up] Menu

Item	Description	Reference
Format	Formats the SD Memory Card / MultiMediaCard.	p.90
Sound	Sets the volume and type of button operation sound, start-up sound, shutter sound, and self-timer sound.	p.91
Date Adjust	Sets the date and time.	p.92
World Time	Sets world time.	p.93
Language/言語	Switches the language for displaying menus and messages.	p.94
Display	Sets the display information.	p.95
Screen Setting	Sets the start-up screen and background color.	p.97
Video Out	Sets the video output format.	p.99
Quick Delete	When this option is turned on, the Delete screen is displayed with [Delete] or [All Images] selected.	p.77
Quick Zoom	For playing back images at the maximum zoom size with the Zoom button pressed only once.	p.70
Auto Power Off	Turns off the power automatically.	p.99
Reset	Returns settings to defaults.	p.99

Setting the Capture Functions

Changing the Mode

Capture mode is for taking pictures. Playback mode is for playing back or erasing images and sound.











Switching Between Capture Mode and Playback Mode

- To change from Capture mode to Playback mode, press the Playback button.
- To change from Playback mode to Capture mode, press the Playback button or the shutter release button halfway.

4

Selecting the Capture Mode

Display the virtual mode dial to select the Capture mode. You can select from 12 Capture modes.

P	Program	The camera automatically sets the shutter speed and aperture for taking still pictures.	
	Landscape	Enhances your landscape photos.	p.50
	Night-Scene Mode	Enables you to take dark scenes such as night views.	
	Night-Scene Portrait	Enables you to take portraits in dark conditions.	
	Portrait	Enhances your portrait photos.	
	Surf and Snow	Enhances pictures taken against dazzling backgrounds such as beaches or snow.	
	Flower	Enhances your flower photos.	
	Sunset	Beautiful results on pictures of sunsets or sunrises.	
	Fireworks	Enhances your fireworks photos.	
	Snap Mode	Enhances your snap photos.	
	Movie Picture Mode	You can take movie pictures.	
	Panorama Assist Mode	You can set up and take panorama photos.	

1 Press the four-way controller (▼) in Capture Mode.

The virtual mode dial is displayed.



2 Press the four-way controller (◀▶) to select your desired display mode.

The selected icon is displayed in a frame.

3 Press the OK button.

The icon of the selected Capture mode is displayed and the camera is ready to take pictures.



When the focus mode is set to manual, the four-way controller (▲▼) becomes the manual focus button and the virtual mode dial cannot be displayed. Press ▲MF to select the Autofocus mode or other mode, then use the four-way controller (▼) to change the mode.

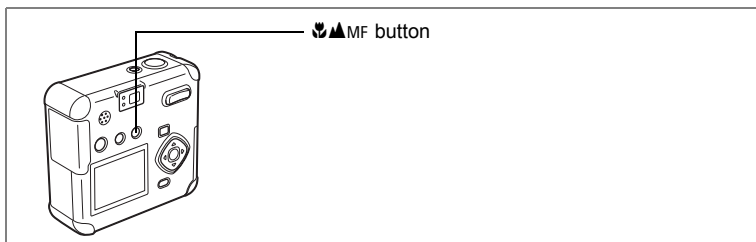

Changing Focus Settings

Focus Mode

(No icon)	Autofocus mode	Focuses on objects in the focusing area when the shutter release button is pressed halfway. Use when the distance to the subject is more than 30cm.
	Macro mode	Use when the distance to the subject is between approximately 1cm~50cm (Wide) and 20cm~50cm (Tele). Focuses on objects in the focusing area when the shutter release button is pressed halfway.
	Infinity-landscape mode	Use for taking pictures of distant objects.
MF	Manual focus mode	Adjust focus manually.

1 Pressing ▲MF in Capture mode will switch focus modes, and the current setting is displayed on the LCD monitor.

The camera is ready to take a picture in the set focus mode.



- The focus mode default setting is the Autofocus mode.
- In Movie Picture mode (p.63), only the fixed focus is available.
- If you use the flash in Macro mode, the image may be overexposed or a dark area may appear at the bottom right of the picture.



If you take a picture while looking through the viewfinder when the focus mode is set to Macro mode, the range of the resulting picture will differ from what was seen in the viewfinder. Be sure to check the image on the LCD monitor.

Manual Focus

On the **MF** setting, press the four-way controller (▲▼) to enlarge the central portion of the screen to full screen on the LCD monitor.

Adjust the focus with the four-way controller while watching the image on the monitor.



For distant focus



For closer focus

Once the focus is set, press any button other than the four-way controller (▲▼), or take your finger off of the four-way controller for about 2 seconds. The camera will switch to the standard Capture screen.



- When focusing, hold down the four-way controller (▲▼) to focus quickly.
- Enlarged display is not available near maximum magnification in digital zoom.

Saving the Focus Mode p.68

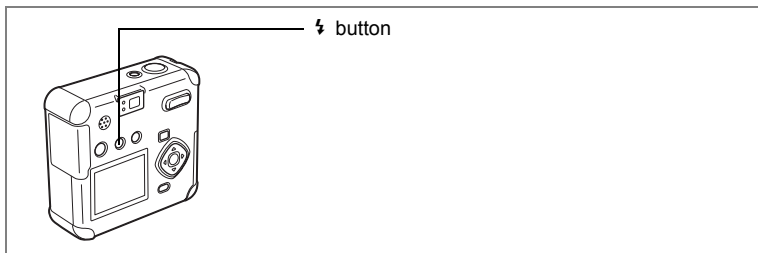

Selecting the Flash Mode

(No icon)	Auto	The flash discharges automatically based on light conditions.
☹	Flash Off	The flash never discharges regardless of light conditions.
⚡	Flash On	The flash always discharges regardless of light conditions.
Ⓜ	Auto flash + red-eye reduction	Reduces red-eye in the picture, caused by the flash reflecting from the subject's eyes. The flash discharges automatically.
Ⓜ⚡	Flash On + red-eye reduction	Reduces red-eye in the picture, caused by the flash reflecting from the subject's eyes. The flash discharges regardless of lighting conditions.



- The flash is always off when the Capture mode is set to , Continuous shooting, Infinity-Landscape, or Fireworks.
- When using the flash, it always discharges once before taking the picture, to assist with metering.
- In Auto + red-eye reduction or Flash On + red-eye reduction, the flash discharges once before taking the picture to make the iris of the subject's eyes contract, shortly before firing again to take the picture.
- The shutter speed will be slower with the flash off, or in low light conditions such as a night scene. Use a tripod to prevent camera movement.

1 Press the button in Capture mode.

This will switch flash modes, and the current icon will be displayed on the LCD monitor.

The camera is ready to take a picture in the selected flash mode.

Status of the Flash Status Lamp p.25
Saving the Flash Mode p.68

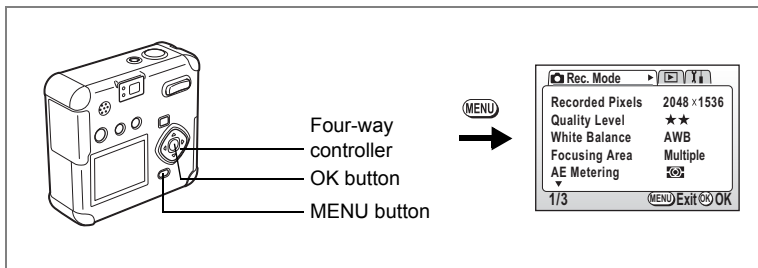

P Picture Mode

Selecting the Quality Level

Select the image compression rate.

The more ★ there are, the better the quality and the larger the file.

The image file size will also differ according to Recorded Pixels settings.

★★★	Best	This has the lowest compression rate, and is suited for printing large pictures on A4 paper.
★★	Better	This has a standard compression rate, and is suited for viewing as standard photographs or on your computer screen.
★	Good	Highest compression rate. Suited for attaching to e-mail or for creating websites.

1 Press the MENU button in Capture mode.

The [Rec. Mode] menu will be displayed.

2 Select [Quality Level] on the [Rec. Mode] menu.

3 Press the four-way controller (◀▶) to change the quality level.

4 Press the OK button.

The camera is ready to take the picture.

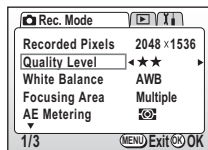



Four-way
controller
OK button
MENU button

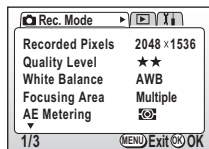

P Picture Mode

Adjusting the White Balance

4

Taking Pictures

Adjusts for natural coloring in your picture, according to the lighting.

AWB	Auto	The camera makes the adjustment automatically.
	Daylight	For taking pictures outside in sunlight.
	Shade	For taking pictures outside in the shade.
	Tungsten Light	For taking pictures under standard light bulbs or other tungsten light.
	Fluorescent Light	For taking pictures under fluorescent light.
	Manual	For taking pictures by manually adjusting the white balance.

- 1 Press the MENU button in Capture mode.**
The [Rec. Mode] menu will be displayed.
- 2 Select [White Balance] on the [Rec. Mode] menu.**
- 3 Press the four-way controller (▶).**
The White Balance selection screen is displayed.
- 4 Press the four-way controller (▲▼) to change the setting.**
- 5 Press the OK button twice.**
The camera is ready to take the picture.

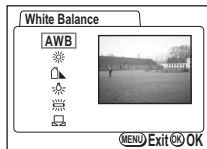

Saving the White Balance p.68

Setting Manually

- 1 Select [] (Manual) on the White Balance selection screen.**
- 2 Point your camera at white paper to fill the screen.**
- 3 Press the OK button.**
- 4 Press the OK button.**



The LCD monitor will display “Adjusting”, and return to the menu screen when the white balance is adjusted.

The camera is ready to take a picture.

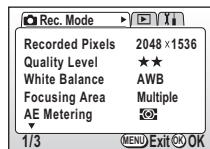
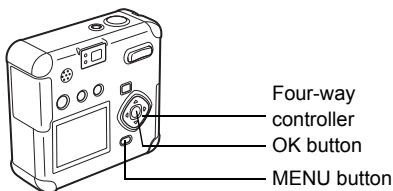

P Picture Mode

Setting the Focusing Area

4

You can change the area for autofocus (Focusing Area).

Multiple	Normal range
Spot	The autofocus range becomes smaller.

1 Press the MENU button in Capture mode.

The [Rec. Mode] menu will be displayed.

2 Select [Focusing Area] on the [Rec. Mode] menu.

3 Press the four-way controller (◀▶) to change the focusing area.

4 Press the OK button.

The camera is ready to take the picture.

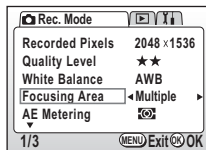

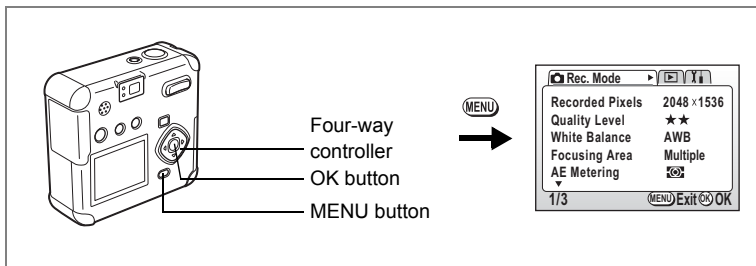

P Picture Mode

Setting the Light Metering Range

You can choose the part of the screen to use for measuring brightness and determining exposure.

	Multi-segment	Detailed measurement of entire screen to determine exposure.
	Center-weighted	Measures mainly the center of the screen to determine exposure.
	Spot	Measures only the very center of the screen to determine exposure.

- 1 Press the MENU button in Capture mode.**
The [📷 Rec. Mode] menu will be displayed.
- 2 Select [AE Metering] on the [📷 Rec. Mode] menu.**
- 3 Press the four-way controller (◀▶) to change the metering mode.**
- 4 Press the OK button.**
The camera is ready to take the picture.

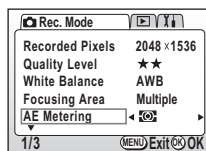

Saving the AE Metering Method p.68

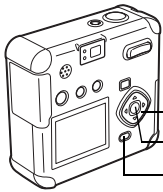

Four-way controller
OK button
MENU button

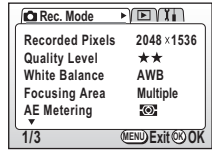

P Picture Mode

Setting Sensitivity

4

You can set the Sensitivity to match the brightness of the surroundings.

Auto	The camera makes the adjustment automatically.
50	<ul style="list-style-type: none"> The lower the Sensitivity (smaller number), the smaller the noise and sharper the image. The shutter speed will be slower in low light conditions.
100	
200	<ul style="list-style-type: none"> The higher the Sensitivity (larger number), the faster the shutter speed in low light conditions. The image will have more noise.
400	

1 Press the MENU button in Capture mode.

The [📷 Rec. Mode] menu will be displayed.

2 Select [Sensitivity] on the [📷 Rec. Mode] menu.

3 Press the four-way controller (◀▶) to change the sensitivity.

4 Press the OK button.

The camera is ready to take the picture.

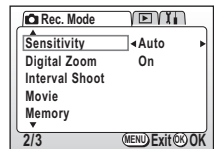

The only available AUTO settings are 50, 100, and 200.

Saving the Sensitivity p.68

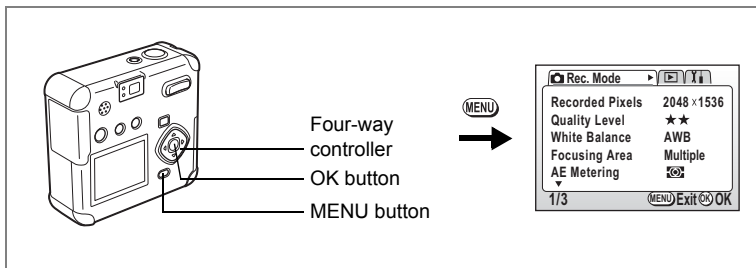

P Picture Mode

Setting Image Sharpness

You can make the image outlines sharp or soft.

1 Press the MENU button in Capture mode.

The [Rec. Mode] menu will be displayed.

2 Select [Sharpness] on the [Rec. Mode] menu.

3 Press the four-way controller (◀▶) to select (Normal), (Hard), or (Soft).

4 Press the OK button.

The camera is ready to take the picture.

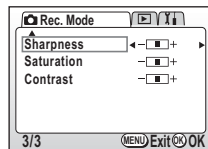

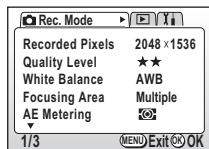
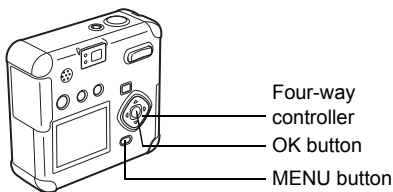

P Picture Mode

Setting Color Saturation

4

Taking Pictures

This sets the color saturation.

1 Press the MENU button in Capture mode.

The [📷 Rec. Mode] menu will be displayed.

2 Select [Saturation] on the [📷 Rec. Mode] menu.

3 Press the four-way controller (◀▶) to select (Normal), (High), or (Low).

4 Press the OK button.

The camera is ready to take the picture.

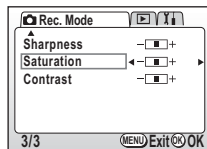

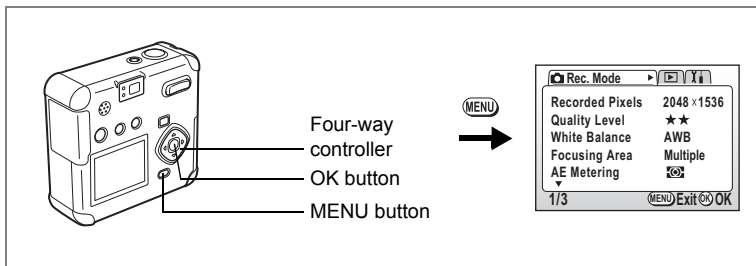

P Picture Mode

Setting the Image Contrast

You can set the image contrast level.

1 Press the MENU button in Capture mode.

The [Rec. Mode] menu will be displayed.

2 Select [Contrast] on the [Rec. Mode] menu.

3 Press the four-way controller (◀▶) to select (Normal), (High), or (Low).

4 Press the OK button.

The camera is ready to take the picture.

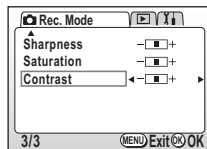

Taking Pictures

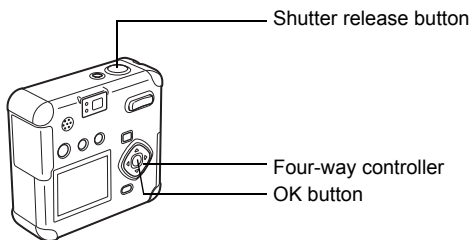

4

Taking Pictures

Program Mode

In Program Mode (**P**), you can set all the functions and take pictures.

1 Press the four-way controller (▼) in Capture Mode.

The virtual mode dial is displayed.

2 Press the four-way controller (◀▶) to select [**P**].

3 Press the OK button.

The camera is ready to take the picture.

4 Set the functions you want to use.

See “Setting the Capture Functions” (p.36-p.49) for instructions.

5 Press the shutter release button.

The picture is taken.

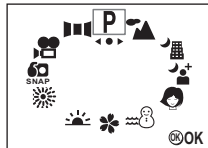

Taking Still Pictures p.24

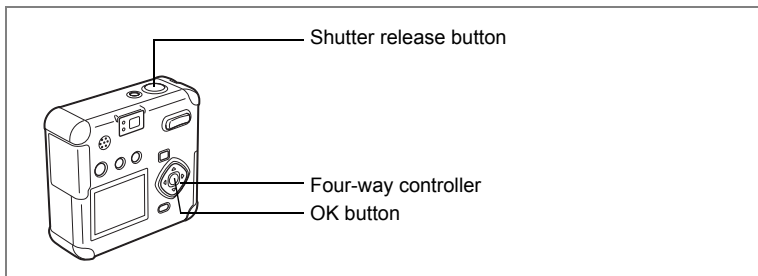









Picture Mode

You can match your settings to the situation.

Picture Mode

There are nine modes available.

	Landscape	Enhances your landscape photos.
	Night-Scene Mode	Enables you to take dark scenes such as night views.
	Night-Scene Portrait	Enables you to take portraits in dark conditions.
	Portrait	Enhances your portrait photos.
	Surf and Snow	Enhances pictures taken against dazzling backgrounds such as beaches or snow.
	Flower	Enhances your flower photos.
	Sunset	Beautiful results on pictures of sunsets or sunrises.
	Fireworks	Enhances your fireworks photos.
	Snap Mode	Enhances your snap photos.

1 Press the four-way controller (▼) in Capture Mode.

The virtual mode dial is displayed.

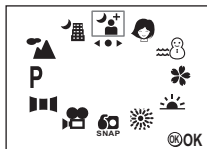
2 Press the four-way controller (◀▶) to select your desired display mode.**3 Press the OK button.**

The Picture mode is selected.

4 Press the shutter release button.

The picture is taken.



In Picture mode, the EV compensation, saturation, contrast, sharpness, and white balance are automatically set to the optimum values for each mode. (You can change the settings.)



To avoid camera movement in Night-scene, Night-scene Portrait, Sunset, or Fireworks mode, you are recommended to fix the camera on a tripod.

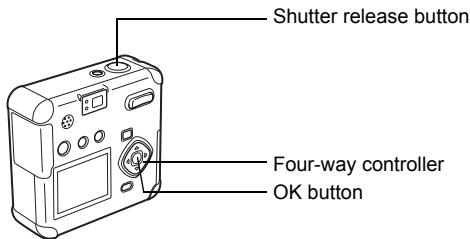

Taking Panorama Pictures (Panorama Assist Mode)

Using the included software (ACDSee™), you can easily join several images to form one panorama picture. Overlap and stitch the edges of images taken in Panorama Assist mode and create a panorama image.

1 Press the four-way controller (▼) in Capture Mode.

The virtual mode dial is displayed.

2 Press the four-way controller (◀▶) to select [] (Panorama Assist)].

3 Press the OK button.

4 Press the four-way controller to set the shift direction.

- ◀ joins the images at the left.
- ▶ joins the images at the right.
- ▲ joins the images at the top.
- ▼ joins the images at the bottom.

The explanation described below indicates that ▶ is set.



5 Take the first image.

Press the shutter release button to take the first image. The right edge of the image is displayed in half transparent form at the left of the LCD monitor.



6 Take the second image.

Move the camera to the right until the real image approx. coincides with the half transparent one, and then press the shutter release button for taking the second image. Repeat the same procedure for taking the third image and following pictures.



7 Press the four-way controller (▼).

The virtual mode dial is displayed, and switch to another Capture mode to cease this Panorama mode.

Caution

- It is impossible to create a panorama picture by joining images using the camera itself. Use the panorama software, ACDSee, packed together with the camera. For details on joining panorama images, see the separate booklet PC Connection Manual.
- Continuous shooting and interval shooting are not possible in Panorama assist mode.
- You need a Windows PC for joining panorama pictures. (The provided software is not Macintosh-compatible.)

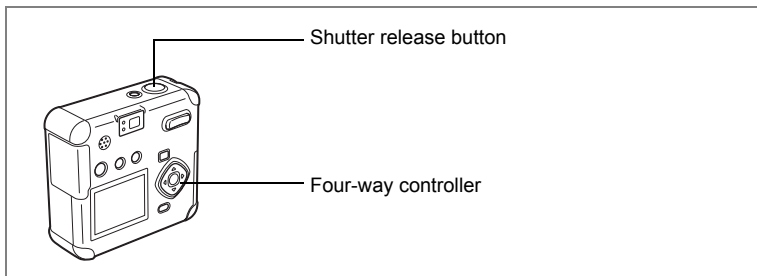

P Picture Mode   

Using the Self-Timer

The picture will be taken 10 seconds after the shutter release button is pressed.

1 Press the four-way controller (▲) to display  on the LCD monitor.

2 Press the shutter release button.

The self-timer is engaged and the self-timer lamp lights. The picture is taken about 3 seconds after the self-timer lamp begins to blink.

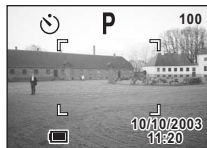

- The number of seconds until the picture is taken will be displayed on the LCD monitor.
- Pressing the four-way controller or the MENU button during the countdown display will cancel the self-timer.

Playing Back Still Pictures  p.26

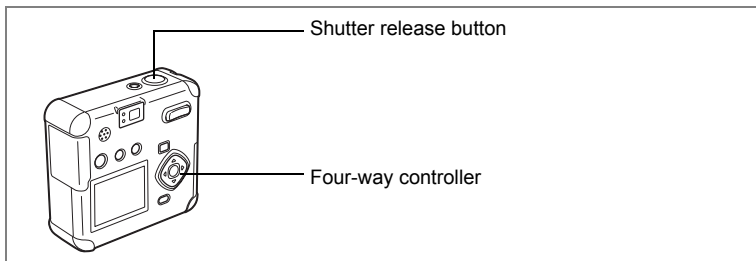



P Picture Mode

Continuous Shooting (Continuous Shooting/ Multi Continuous Shooting)

Pictures are taken continually while the shutter release button is pressed. There are Continuous Shooting and Multi Continuous Shooting as follows.

	Continuous Shooting	Images are captured, processed, and saved one by one.
	Multi Continuous Shooting	Pictures are taken four frames at a time and saved as a single image.

1 Press the four-way controller (**▲**) to display  or  on the LCD monitor.

2 Press the shutter release button.

Pictures are taken continually while the shutter release button is pressed.

Recording stops when you release the shutter release button.

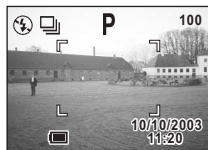

Playing Back Still Pictures  p.26



- You can continue shooting until the SD Memory Card / MultiMediaCard is full.
- The interval between continuous shots differs according to recorded pixels and quality level settings.



- The flash will not fire in Continuous Shooting or Multi Continuous Shooting mode.
- Continuous Shooting and Multi Continuous Shooting cannot be used in Movie Picture, Panorama Assist, Night-Scene, Night-Scene Portrait, or Fireworks mode.

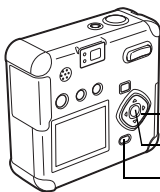

Four-way controller

OK button

MENU button

P Picture Mode

Taking Pictures at Fixed Intervals (Interval Shoot)

In this mode, still pictures are taken automatically at a fixed interval.

1 Press the four-way controller (▲) to display  on the LCD monitor.

2 Press the shutter release button.

Interval shooting will start with the following settings.

- Interval 00min10sec
- Number of Shot 02
- Start Time 00hr00min

When shooting is finished, the camera turns off automatically.

Setting the interval, number of shot, and start time

1 Press the MENU button in Capture mode.

The [ Rec. Mode] menu will be displayed.

2 Select [Interval Shoot] on the [ Rec. Mode] menu.

3 Press the four-way controller (▶).

The Interval Shooting menu will be displayed and [Interval] will be selected.

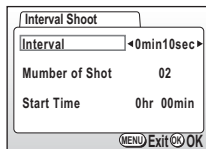

4 Set the interval time.

1. Press the four-way controller (▶).
▲▼ are displayed above and below the number of minutes.
2. Use the four-way controller (▲▼) to change the number of minutes, then press the four-way controller (▶).
▲▼ are displayed above and below the number of seconds.
3. Use the four-way controller (▲▼) to change the number of seconds, then press the four-way controller (▶).
4. Press the four-way controller (▼).
The frame will move to [Number of shot].

5 Use the four-way controller (◀▶) to change the number of pictures, then press the four-way controller (▼).

The frame will move to [Start Time].

6 Set the time to start shooting.

1. Press the four-way controller (▶).
▲▼ are displayed above and below the number of hours.
2. Use the four-way controller (▲▼) to change the number of hours, then press the four-way controller (▶).
▲▼ are displayed above and below the number of minutes.
3. Use the four-way controller (▲▼) to change the number of minutes, then press the four-way controller (▶).

7 Press the OK button 2 times.

Playing Back Still Pictures p.26



- Interval shooting can be set at intervals of 10 seconds to 4 minutes in units of 1 second, and intervals of 4 minutes to 99 minutes in units of 1 minute. Intervals of less than 10 seconds cannot be set.
- The number of pictures can be set in the range of 2 to 99 pictures.
- The start time can be set between 0 minutes and 23 hours 59 minutes in units of 1 minute.
- If the start time is set to 0 minutes, the first picture will be taken as soon as the shutter release button is pressed.
- If you press the power switch on during standby, the remaining number of pictures and interval time will be displayed on the LCD monitor. If you press the MENU button, the message "Stop interval shooting?" will be displayed. To cancel interval shooting, press the OK button.
- If the SD Memory Card / MultiMediaCard runs out of memory, interval shooting stops and the camera turns off automatically.



Interval shooting is not possible in Movie Picture or Panorama Assist mode.

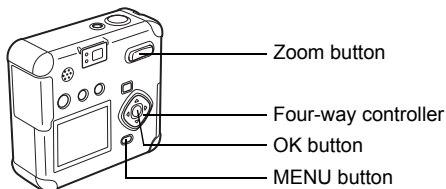

P Picture Mode

Using the Zoom

You can use the Zoom to take pictures in Tele or Wide mode.

1 Press the Zoom button in Capture mode.

- Tele: Subject becomes larger.
- Wide: Subject becomes smaller.

When the digital zoom function is disabled, the optical zoom can be used to enlarge the subject up to 2.8 times.

When the digital zoom function is enabled, you can further enlarge the subject up to 11.2 times.

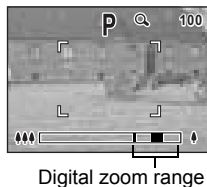
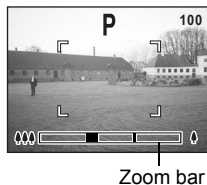

Saving the Zoom Position p.68

4

Enabling the Digital Zoom Function

1 Press the MENU button in Capture mode.

The [📷 Rec. Mode] menu will be displayed.

2 Press the four-way controller (▼) to select [Digital Zoom].

3 Press the four-way controller (▶) to select On.

4 Press the OK button.

The camera is ready to take the picture.

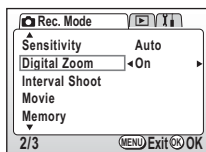

Saving the Digital Zoom Function Setting p.68

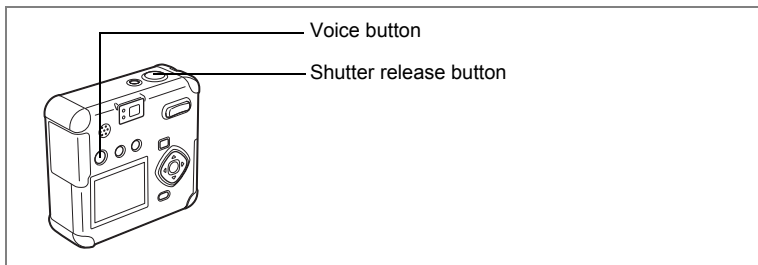

Recording Sound (Voice Recording Mode)

This mode is for recording sound. The recordable time is displayed on the LCD monitor according to how much memory is available on the SD Memory Card / MultiMediaCard.

1 Press the button in Capture mode.

The recordable time is displayed on the LCD monitor.

1. Remaining time 2. Recording time



2 Press the shutter release button.

Recording starts.  flashes during recording.

3 Press the shutter release button.

Recording stops. The remaining available recording time is displayed.

Playing Back Sound  p.76



Sound is saved as a monaural WAVE file (PCM method).



Four-way controller

P Picture Mode

EV Compensation

4

Taking Pictures

Use EV Compensation when you want to intentionally over expose (brighten) or under expose (darken) your picture.

1 Press the four-way controller (◀▶) in Capture Mode.

- ▶ Adjusts the exposure to over-expose (+ side), ◀ Adjusts the exposure to under-expose (- side).

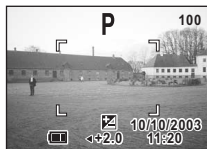

The EV Compensation setting is displayed on the LCD monitor.



When you press the four-way controller (◀▶) once, or when you set the setting to ± 0 , the display will disappear in two seconds.

Saving the EV Compensation Setting p.68

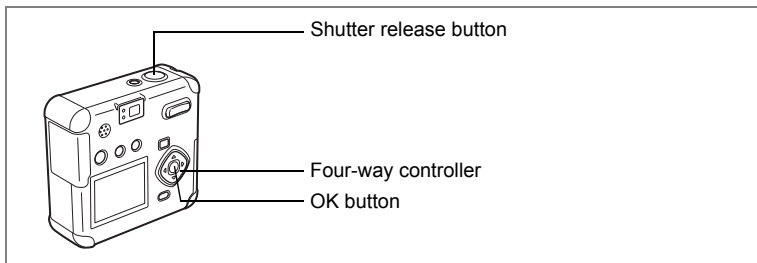

Taking Movie Pictures (Movie Picture Mode)

You can take movie pictures. The recording time for a single movie is displayed at the top right of the LCD monitor. Sound can be recorded at the same time.

You can select either 320×240 or 160×120 for recorded pixels in movie picture mode p.65

1 Press the four-way controller (▼) in Capture Mode.

The virtual mode dial is displayed.

2 Press the four-way controller (◀▶) to select [] (Movie).

3 Press the OK button.



- 1 Flash OFF icon
- 2 Movie Picture mode icon
- 3 Recording time

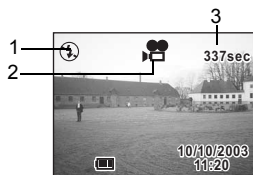

4 Press the shutter release button.

Recording will begin.

You can switch the image size using the Zoom button.

- Subject becomes bigger.
- Subject becomes smaller.

5 Press the shutter release button.

Recording will end. The remaining available recording time is displayed.

Recording by holding down the shutter release button

If you hold down the shutter release button for one second or more, the camera will record while you hold down the button. Recording stops when you release the shutter release button.

Playing Back Movie Pictures  p.73

Caution

- The flash will not fire in Movie Picture mode.
- Continuous shooting and interval shooting are not possible in Movie Picture mode.
- The focus is fixed in movie picture mode.
- When shooting in Movie Picture mode, only the digital zoom can be operated.

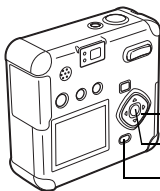

Four-way controller

OK button

MENU button



Changing the Recorded Pixels Setting When Taking Movie Pictures

In movie picture mode, you can select either 320×240 or 160×120 for the number of recorded pixels (resolution).

The more pixels there are, the larger the image size but the smaller the recording time.

1 Press the MENU button in Capture mode.

The [📷 Rec. Mode] menu will be displayed.

2 Select [Movie] on the [📷 Rec. Mode] menu.

3 Press the four-way controller (▶).

The movie setup screen will be displayed.

4 Press the four-way controller (◀▶) to change the recorded pixels.

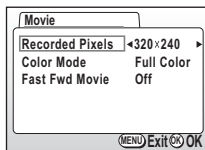

5 Press the OK button 2 times.

The camera is ready to record a movie.

Taking Movie Pictures p.63

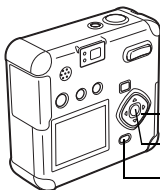

Four-way controller

OK button

MENU button



Changing the Color Mode Setting When Taking Movie Pictures

4

You can record a movie picture in one of three color mode settings: full-color, black-and-white, or sepia.

1 Press the MENU button in Capture mode.

The [Rec. Mode] menu will be displayed.

2 Select [Movie] on the [Rec. Mode] menu.

3 Press the four-way controller (▶).

The movie setup screen will be displayed.

4 Select [Color Mode] with the four-way controller (▼).

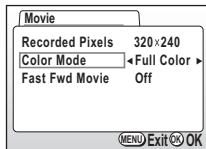

5 Press the four-way controller (◀▶) to change the color mode.

6 Press the OK button 2 times.

The camera is ready to record a movie.

Taking Movie Pictures p.63

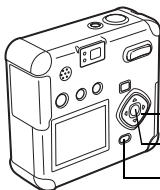

Four-way controller

OK button

MENU button



Taking Fast Forward Movie Pictures (Fast Fwd Movie)

This mode lets you take movie pictures at a delayed frame rate so that when you play the movie back, the action appears speeded up.

- 1 Press the MENU button in Capture mode.**
The [📷 Rec. Mode] menu will be displayed.
- 2 Select [Movie] on the [📷 Rec. Mode] menu.**
- 3 Press the four-way controller (▶).**
The movie setup screen will be displayed.
- 4 Press the four-way controller (▼) to select [Fast Fwd Movie].**
- 5 Press the four-way controller (◀▶) to select [Off (x1)], [x2], [x5], [x10], [x20], [x50], or [x100].**
- 6 Press the OK button 2 times.**

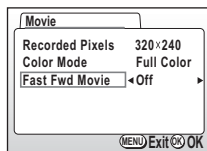

Taking Movie Pictures p.63



- Off (x1) is the normal movie picture setting (15 frames per second). When x2 or x5 is selected, the number of frames recorded per second decreases by 1/2 or 1/5, respectively.
- As movie pictures are normally played back at the rate of 15 frames per second, movies taken at x2 are played back twice as fast and movies taken at x5 are played back five times as fast.
- Sound cannot be recorded.

Saving the Settings

Saving the Menu Items (Memory)

You can choose whether to save the set values when the camera is turned off. If you select On, the camera saves the settings in effect just before the camera is turned off. If you select Off, the settings return to default settings when the camera is turned off.

Item	Description	Default Setting
Flash	Saves the Flash mode setting selected with the button.	<input checked="" type="checkbox"/>
White Balance	Saves the White Balance settings on the Rec. Mode menu.	<input type="checkbox"/>
EV compensation	Saves the EV compensation settings.	<input type="checkbox"/>
Digital Zoom	Saves the Digital Zoom settings on the Rec. Mode menu.	<input checked="" type="checkbox"/>
AE Metering	Saves the AE Metering settings on the Rec. Mode menu.	<input type="checkbox"/>
Sensitivity	Saves the Sensitivity settings on the Rec. Mode menu.	<input type="checkbox"/>
Focus Mode	Saves the Focus Mode settings.	<input type="checkbox"/>
Zoom Position	Saves the Zoom Position settings.	<input type="checkbox"/>
MF Position	The focus position set by Manual Focus is saved.	<input type="checkbox"/>
File No.	Saves the file numbers. File numbers will continue to have sequential numbers even after changing the SD Memory Card / MultiMediaCard.	<input checked="" type="checkbox"/>



- Menu items not included in Memory will also be saved with the settings selected on the menus for each function.
- Zoom positions set within the digital zoom range will not be saved even when Zoom Position is set to On in Memory.

1 Press the MENU button in Capture mode.

2 Press the four-way controller (▲▼) to select [Memory].

3 Press the four-way controller (▶).

The Memory menu will be displayed.

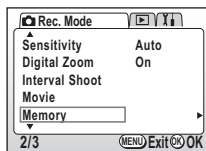

4 Press the four-way controller (▲▼) to select the item.

5 Press the four-way controller (◀▶) to select (On) or (Off).

6 Press the OK button 2 times.

The camera is ready to take a picture.

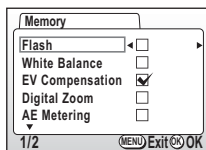

Playing Back Images

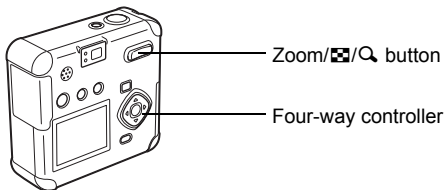

Playing Back Still Pictures

See “Playing Back Images” (p.26) and “Playing Back Previous or Next Images” (p.26).

Zoom Display

You can display images magnified up to 8 times. A guide to operation is displayed on the LCD monitor during magnification.

- 1 Enter the Playback mode and choose the image you want to magnify with the four-way controller (◀▶).**
- 2 Press ▲/Q on the Zoom/Matrix/Quick button.**

The image will be magnified (1 to 8 times). Continue to press to magnify the image even greater.

- **The following operations can be performed while the magnified image is displayed.**

Four-way controller (▲▼◀▶)	Moves the position to be magnified.
Zoom/Matrix/Quick button (▲)	Makes the image larger.
Zoom/Matrix/Quick button (◆◆◆)	Makes the image smaller.
OK button	Turns the guide marks on/off.



- 3 Press the OK button.**

Zoom playback will end.



If you set [Quick Zoom] in the [X] Set-up menu to ON, the image will be magnified eight times when (▲/Q) is pressed in **step 2**.



Movie pictures cannot be magnified.

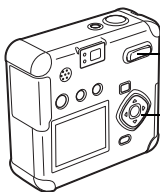

Zoom/Matrix/Quick button

Four-way controller

Nine-image Display

You can display nine images at the same time.

- 1 Enter the Playback mode and choose the image you want to place in the center with the four-way controller (◀▶).**
- 2 Press  on the Zoom/Matrix/Quick button.**

Nine images will be displayed with the selected image in the center.

Choose an image with the four-way controller (▲▼◀▶). When ten or more images have been recorded, if you press the four-way controller (▶) while the bottom right image is selected,

the next nine images will be displayed, and if you press the four-way controller (◀) while the top left image is selected, the previous nine images will be displayed.

Similarly, if you press the four-way controller (▲) while an image on the top row is selected, the previous nine images will be displayed, and if you press the four-way controller (▼) while an image on the bottom row is selected, the next nine images will be displayed.

- 3 Press the OK button.**

The screen will return to single-image display of the selected image. In the case of movie pictures, the first frame will be displayed.



Selection screen



Sound files are displayed with .

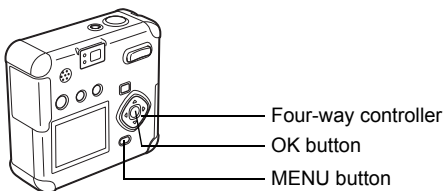

Using Slideshow for Continuous Playback

You can continuously play back all the images on the SD Memory Card / MultiMediaCard.

1 Enter the Playback mode and choose the image with which to start the slideshow with the four-way controller (◀▶).

2 Press the MENU button.

The [Playback] menu will be displayed.

3 Select [Slideshow] with the four-way controller (▼).

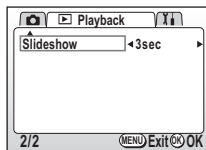

4 Use the four-way controller (◀▶) to change the playback interval.

Choose from the following: 3 sec, 5 sec, 10 sec, 20 sec, or 30 sec.

5 Press the OK button.

Playback will start at the set interval.



- If you press the four-way controller or any buttons, such as the MENU button, during continuous playback, the slideshow will stop.
- The slideshow will continue until you press any button.
- Movie pictures and pictures with a voice memo will be played through to the end before the next picture is played back, regardless of the set playback interval.

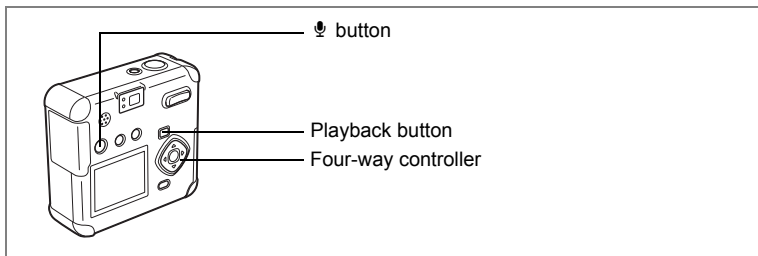

Playing Back Movie Pictures

You can play back movie pictures. A guide to operation is displayed on the LCD monitor during playback. The sound is played back at the same time.

1 Enter the Playback mode and choose the movie picture you want to play with the four-way controller (◀▶).

2 Press the four-way controller (▲).

Playback will start.

• **The following operations can be performed during playback.**

- Four-way controller (◀) Reverse playback
- Four-way controller (▶) Forward playback
- Four-way controller (▲) Pauses playback.
- Zoom/⊞/Q button (↑) Increases the volume.
- Zoom/⊞/Q button (⚡) Decreases the volume.

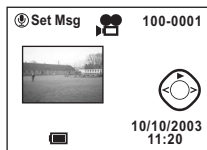

• **The following operations can be performed while Pause is engaged.**

- Four-way controller (◀) Single frame reverse playback
- Four-way controller (▶) Single frame forward playback
- Four-way controller (▲) Cancels Pause. (Playback resumes.)

3 Press the four-way controller (▼).

Playback will stop.

4 Press the Playback button.

The camera will return to the Capture mode.

Adding a Voice Memo

You can add a voice memo to a recorded image.

- 1 Enter the playback mode and choose the image to which you want to add a voice memo with the four-way controller (◀▶).**

If the image has no voice memo, the screen for recording a voice memo is displayed on the LCD monitor.



- 2 Press the  button.**

Recording starts.

- 3 Press the  button.**

Recording stops.



- 4 Press the four-way controller (▼).**

The recorded voice memo will be played back.

- 5 Press the four-way controller (▼).**

Playback stops.



- A voice memo cannot be added to protected () images.
- Images with a voice memo are indicated with  on the LCD monitor.

Recording a Voice Message

A voice memo added to an image can be set as a voice message. The  button flashes during voice message recording, indicating that there is a voice message.

1 Press the MENU button in Playback mode.

The Playback Mode menu is displayed.

2 Select [Playback Message] from the Playback Mode menu.



3 Press the four-way controller (▶).

The Voice Message Recording screen will be displayed.

4 Press the four-way controller (◀▶) to select the image to be used for the voice message.

5 Press the OK button.

The camera turns off, and the voice message is set.

Adding a Voice Memo  p.74

Playing Back a Voice Message

You can play back a voice message.

1 Press the  button.

The image will be displayed and the voice memo will be played back.



- Turn the camera on during voice message settings to perform regular operations. Turn the camera off again to return to voice message recording.
- To switch from voice message recording to Capture mode, turn the camera off and then turn it on again.



Playback button

Four-way controller

Playing Back Sound

You can play back the recording you made in Voice Recording mode.

1 Enter the Playback mode and choose the recording you want to play with the four-way controller (◀▶).

2 Press the four-way controller (▲).

Playback will start.

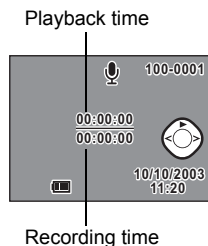

• **The following operations can be performed during playback.**

Four-way controller (◀) Rewinds and plays back the recorded sound.

Four-way controller (▶) Advances and plays back the recorded sound.

Zoom/☒/Q button (▲) Increases the volume.

Zoom/☒/Q button (▼) Decreases the volume.

3 Press the four-way controller (▼).

Playback will stop.

4 Press the Playback button.

The camera will return to the Capture mode.

Deleting Images

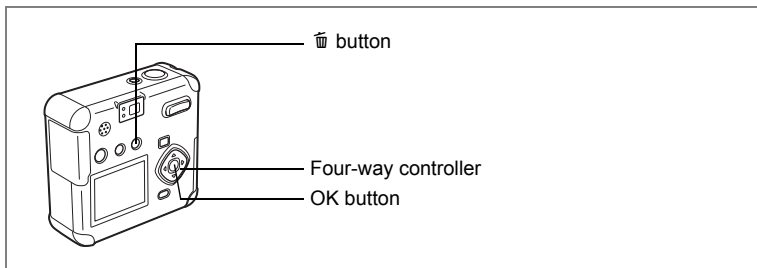

Deleting an Image

- 1 Enter the Playback mode and choose the image you want to delete with the four-way controller (◀▶).**
- 2 Press the trash button.**
The Delete screen will be displayed.
- 3 Select [Delete] with the four-way controller (▲).**
- 4 Press the OK button.**



- You can also delete images during Instant Review (p.25).
- You cannot delete protected (🔒) images.

Deleting a Voice Memo

If an image has a voice memo (indicated with [M]), you can delete the voice memo without deleting the image.

- 1 Enter the Playback mode and choose the image with the voice memo that you want to delete with the four-way controller (◀▶).**
- 2 Press the  button.**
The Sound Delete screen will be displayed.
- 3 Select [Sound Delete] with the four-way controller (▲).**
- 4 Press the OK button.**



Select [Delete] in **step 3** above to delete both the image and the voice memo.

5

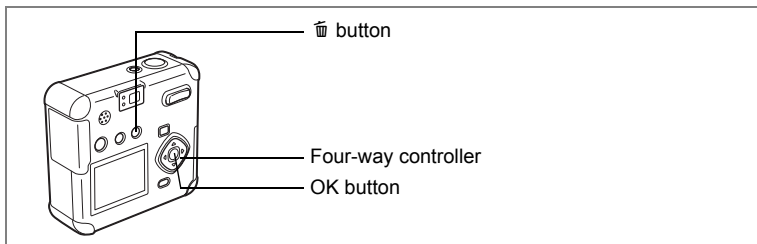

Deleting All Images

You can delete all the images/sound at once.

Caution

- Once deleted, images/sounds cannot be restored.
- You cannot delete protected images/sounds.

1 Enter the Playback mode and press the button twice.

The Delete All Images/Sound screen will be displayed.

2 Select [Delete All] with the four-way controller ().

3 Press the OK button.



5

Playback/Deleting

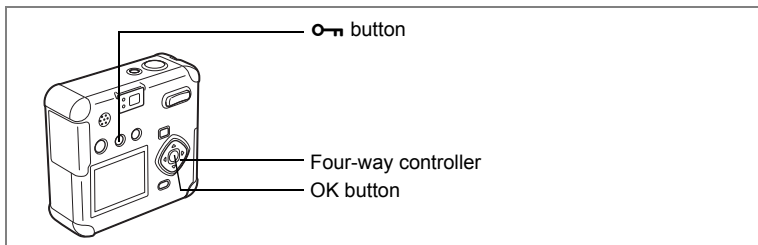

Protecting Images from Deletion (Protect)

You can protect images/sounds from being accidentally deleted.

- 1 Enter the Playback mode and choose the image or sound you want to protect with the four-way controller (◀▶).**
- 2 Press the  button.**
The Protect screen will be displayed.
- 3 Select [Protect] with the four-way controller (▲).**
- 4 Press the OK button.**

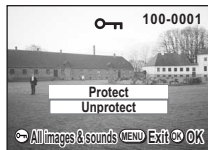

- Select [Unprotect] in **step 3** above to cancel the Protect setting.
-  is displayed during playback of protected images and sounds.

Protect All Images/Sounds

You can protect all images/sounds from being accidentally deleted.

- 1 Enter the Playback mode.**
- 2 Press the  button twice.**
The Protect All Images & Sounds screen will be displayed.
- 3 Select [Protect] with the four-way controller (▲).**
- 4 Press the OK button.**



Select [Unprotect] in **step 3** above to cancel the Protect setting on all of the images/sounds.



Even protected images/sounds will be deleted when formatting the SD Memory Card / MultiMediaCard.

Viewing Images on a TV

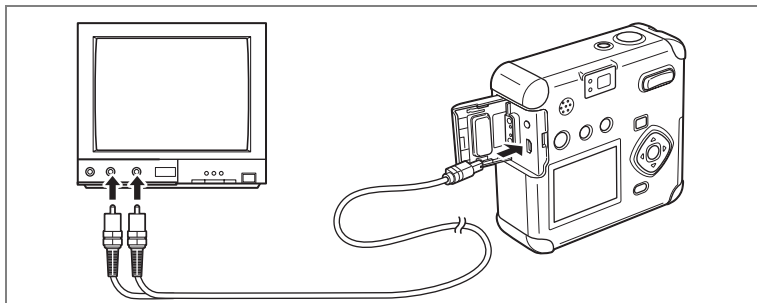

By using the AV cable, you can capture and play back images on a TV or other equipment with a video IN jack. Make sure that both the TV and the camera are turned off before connecting the cable.

- 1 Open the terminal cover and connect the AV cable.
- 2 Connect the sound terminal (white) and image terminal (yellow) of the AV cable to the sound terminal (white) and image input terminal (yellow) of the TV.
- 3 Turn the TV and camera on.

Selecting the Video Output Format  p.99



The LCD monitor is always turned off when the camera is connected to a TV. If you intend to use the camera for a long time, use of the AC adapter (optional) is recommended. Refer to the operating manual for the TV or equipment to which the camera is connected.

Setting the Printing Service (DPOF)

You can print the images on the SD Memory Card / MultiMediaCard using a DPOF (Digital Print Order Format) compatible printer or at a printing service.

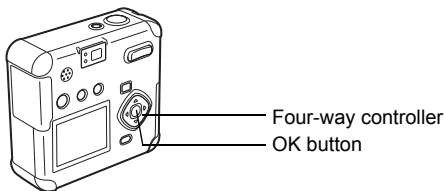

5

Playback/Deleting

Printing Individual Image

Set the following items for each image.

Number of prints: Set the number of prints. You can select to print up to 99 copies. Specify whether you want the date imprinted on the print or not.

1 Enter the Playback mode and use the four-way controller (◀▶) to select the image for which you want to make DPOF settings.

2 Press the four-way controller (▲).

The DPOF screen will be displayed.



3 Use the four-way controller (◀▶) to select the number of prints, then press the four-way controller (▼).

The frame will move to [Date].



4 Use the four-way controller (◀▶) to select either (On) or (Off) for imprinting the date.

- : The date will be imprinted.
- : The date will not be imprinted.

5 Press the OK button.

Prints can be made according to the settings.



- If DPOF settings have already been made for an image, the previously set number of prints and On/Off date setting will be displayed.
- To cancel DPOF settings, set the number of prints to 00 and press the OK button.



- DPOF settings cannot be used with movie pictures.
- Depending on the printer or printing equipment at the photo processing lab, the date may not be imprinted on the pictures even if the DPOF setting was made.

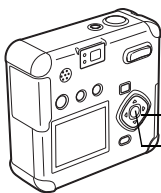

Four-way controller
OK button

Printing All Images

1 Enter the playback mode and press the four-way controller (▲).

The DPOF screen will be displayed.

2 Press the four-way controller (▲).

The DPOF [All Images] screen will be displayed.

3 Use the four-way controller (◀▶) to select the number of prints.

You can select to print up to 99 copies.

4 Press the four-way controller (▼).

5 Use the four-way controller (◀▶) to select either (On) or (Off) for imprinting the date.

: The date will be imprinted.

: The date will not be imprinted.

6 Press the OK button.

Prints can be made according to the settings.



- When the setting to print all images is made, the settings to print individual images will be canceled.
- When you specify the number of prints in the DPOF setting, the number applies to all the images. Before printing, check that the number of prints is correct.
- DPOF settings cannot be used with movie pictures.
- To cancel DPOF settings, set the number of prints to 00 for the setting for all the images.

Editing Images

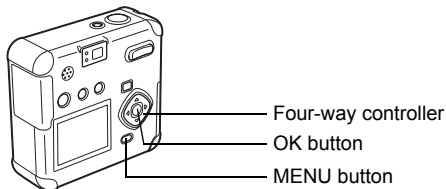

Changing the Image Size

By changing the size and quality of a selected image, you can make the file smaller than the original. After changing the size, the image can be saved as a new image or written over the original image.

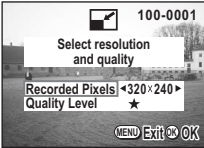
- 1 Press the MENU button.**
 - 2 Press the four-way controller (▶).**
The [▶ Playback] menu will be displayed.
 - 3 Press the four-way controller (▲▼) to select [Resize].**
 - 4 Press the four-way controller (▶).**
The Resize screen will be displayed.
- 
- 5 Use the four-way controller (◀▶) to select the image you want to resize.**
 - 6 Press the OK button.**
- 

- 7** Select [Recorded Pixels] with the four-way controller (◀▶).
- 8** Press the four-way controller (▼).
The frame will move to [Quality Level].
- 9** Press the four-way controller (◀▶) to select [Quality Level].
- 10** Press the OK button.
- 11** Press the four-way controller (▲▼) to select [Overwrite] or [Save as].
- 12** Press the OK button.
The image will be resized.



- Movie pictures cannot be resized.
- You cannot select a larger size than that of the original image.
- You cannot select a higher quality than that of the original image.

Trimming Images

You can trim part of a picture and save it as a separate image.

- 1 Press the MENU button.**
- 2 Press the four-way controller (▶).**
The [▶ Playback] menu will be displayed.
- 3 Press the four-way controller (▲▼) to select [Trimming].**
- 4 Press the four-way controller (▶).**
The image that can be trimmed will be displayed.
- 5 Use the four-way controller (◀▶) to select the image you want to trim.**

- 6 Press the OK button.**

The trimming screen will be displayed.

- 7 Trim the image.**

- **Operations available on the Trimming screen.**

Zoom/📐/🔍 button:

Changes the size of the image.

🔍 button

Toggles between horizontal and vertical.

Four-way controller

(▲▼◀▶):

Moves the trimming position up or down and left or right.

MENU button:

Returns to the screen for selecting the image to be trimmed.

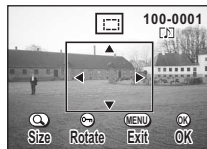

- 8 Press the OK button.**
- 9 Use the four-way controller (◀▶) to select the quality level after trimming.**
- 10 Press the OK button.**

The trimmed image will be saved as a separate image.



- Movie pictures cannot be trimmed.
- You cannot select a higher quality than that of the original image.

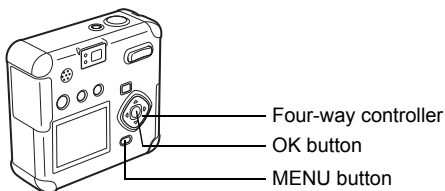

Editing Images with Digital Filters

The filters consist of color filters such as red, blue, and green, a soft filter that produces a fuzzy effect, and a brightness filter that adjusts the brightness of the image. In Digital Filter mode, these filters can be used to edit an image.

- **Color Filters (■)**

Eight colors, black-and-white, sepia, red, pink, violet, blue, green and yellow, are provided for the color filters. When you select a color filter in the Digital Filter mode, the display on the LCD monitor is filtered with the selected color, and the images are saved in that color.

- **Soft Filter (SOFT)**

Images edited with the soft filter can be given a fuzzy effect and saved.

- **Brightness Filter (*)**

Images edited with the brightness filter can be brightened or darkened and saved.

- 1 Press the MENU button in Playback mode.**
- 2 Press the four-way controller (▲▼) to select [Digital Filter].**
- 3 Press the four-way controller (▶).**
The digital filter setup screen will be displayed.
- 4 Use the four-way controller (◀▶) to select the image you want to edit.**
- 5 Press the four-way controller (▲▼) to select the desired digital filter.**

The filtered image will be displayed on the LCD monitor.

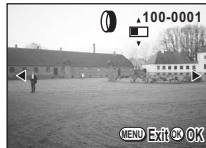

- **Operations available with the brightness filter [✳]**

Zoom/📷/🔍 button (▲) Makes image brighter.

Zoom/📷/🔍 button (▼) Makes the image darker.

- 6 Press the OK button.**
- 7 Press the four-way controller (▲▼) to select [Overwrite] or [Save as].**
- 8 Press the OK button.**

The image edited with the digital filters will be saved.

Camera Settings

How to recall the [Y] Set-up menu

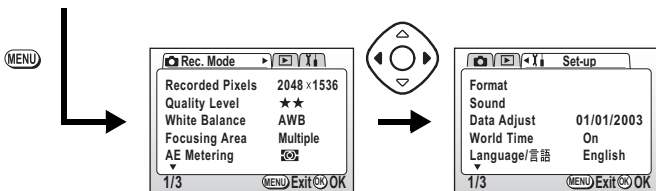
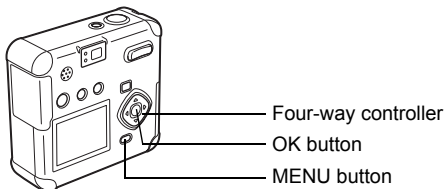

6

Editing/Settings

Formatting an SD Memory Card / MultiMediaCard

Formatting will delete all the data on the SD Memory Card / MultiMediaCard.



- Do not open the card cover while the SD Memory Card / MultiMediaCard is being formatted. The card may be damaged and become unusable.
- SD Memory Cards/MultiMediaCards formatted on a PC or device other than the camera cannot be used. Be sure to format the card with the camera.
- Please note that formatting will delete protected images as well.

- 1 Select [Format] on the [Y] Set-up menu.**
- 2 Press the four-way controller (▶).**
The format screen is displayed.
- 3 Select [Format] with the four-way controller (▲).**
- 4 Press the OK button.**
Formatting begins. When formatting is complete, the camera is ready to take a picture.

Changing the Sound Settings

You can change the volume of the start-up sound, shutter sound, operation sounds, and self-timer sound. You can also change the type of each sound.

Changing the volume

1 Select [Sound] on the [⏏ Set-up] menu.

2 Press the four-way controller (▶).

The Sound screen will be displayed.

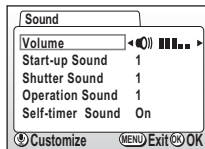

3 Use the four-way controller (◀▶) to change the volume.

4 Press the OK button 2 times.

The camera is ready for capture or playback.

Changing the type of start-up, shutter, operation, or self-timer sound

1 Select [Sound] on the [⏏ Set-up] menu.

2 Press the four-way controller (▶).

The Sound screen will be displayed.

3 Press the four-way controller (▲▼) to select [Start-up Sound] and use the four-way controller (◀▶) to select [1], [2], [3] or [Off].

4 Change [Shutter Sound], [Operation Sound], and [Self-timer Sound] in the same way.

For the self-timer sound, select [On] or [Off].

5 Press the OK button 2 times.

The camera is ready for capture or playback.

How to recall the [Y] Set-up] menu

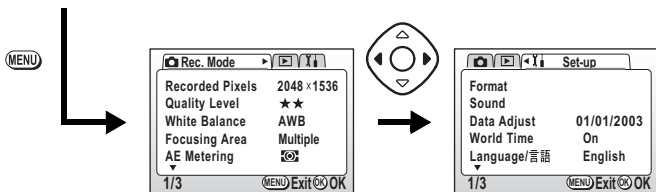
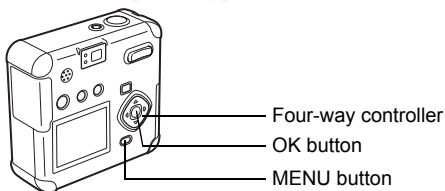

Changing the Date Style and Date / Time

You can change the initial date and time settings. You can also set the date display style. Choose from yy/mm/dd, mm/dd/yy, and dd/mm/yy.

- 1 Select [Date Adjust] on the [Y] Set-up] menu.**
- 2 Press the four-way controller (▶).**

The Date Adjust screen is displayed.

See “Initial Settings (p.20)” for instructions on setting the date and time.

Setting World Time

The date and time set in “Initial Settings (p.20)” are the Home Time (your usual time zone) setting.

Setting World Time enables you to display the local date and time on the monitor when traveling overseas.

1 Select [World Time] on the [F1 Set-up] menu.

2 Press the four-way controller (▶).

The World Time screen will be displayed.

3 Switch (On) and (Off) with the four-way controller (◀▶).

: The time in the country selected in World Time will be displayed.

: The time in the country selected in Home Time will be displayed.

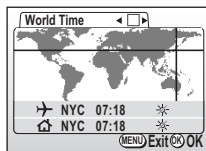

4 Press the four-way controller (▼).

If New York is selected as the world time city, then the cross-shaped line is located in New York on the world map, and then ✈ indicates the current time in New York (NYC).

5 Use the four-way controller (◀▶) to select the World Time city and press the four-way controller (▼).

6 Set the daylight saving time to On (*) or Off (*) with the four-way controller (◀▶).

7 Press the four-way controller (▼).

New York (NYC) is selected as the Home Time city [] at first.

8 Repeat steps 5 and 6 to change the Home Time city and DST setting.

9 Press the OK button twice.

The camera is ready to capture or play back images with the time in the selected city.



See the list on p.103 for available cities and their codes.

How to recall the [Y] Set-up] menu

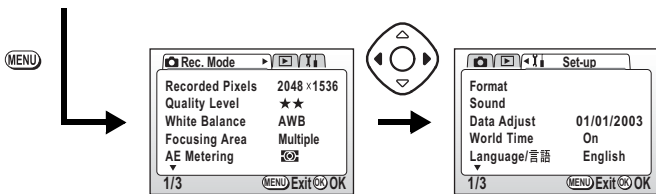
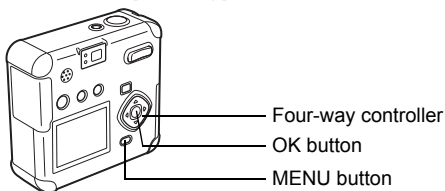

Changing the Display Language

6

Editing/Settings

You can change the language of the menus and error messages.

- 1 Select [Language/ 言語] on the [Y] Set-up] menu.**
- 2 Press the four-way controller (◀▶) to change the language.**
- 3 Press the OK button.**

The camera is ready for capture or playback.

Setting the Display Mode

This determines the content displayed on the LCD monitor. You can select Normal, Histogram, No. Info, or Off. Capture mode and Playback mode display different information on the screen.

Normal

Capture information is displayed.

- 1 Flash
- 2 Drive Mode
- 3 Focus Mode
- 4 Capture Mode
- 5 Autofocus frame
- 6 Capacity remaining
- 7 Battery symbol
- 8 Date and time
- 9 Voice memo
- 10 Folder name/File name
- 11 Protect icon
- 12 Four-way controller operation guide

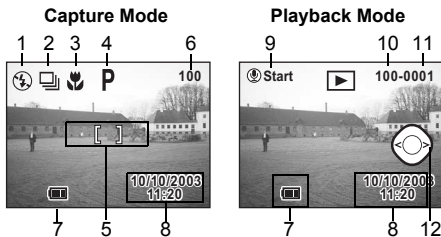

Histogram

Brightness distribution is displayed. The horizontal axis shows the brightness (dark to bright, left to right), and the vertical axis shows the number of pixels.

- 1 Recorded pixels
 - 2 Quality level
 - 3 White balance
 - 4 AE Metering
 - 5 Sensitivity
 - 6 Histogram
 - 7 Aperture value
 - 8 Shutter speed
- During Autofocus, the Autofocus frame is displayed.

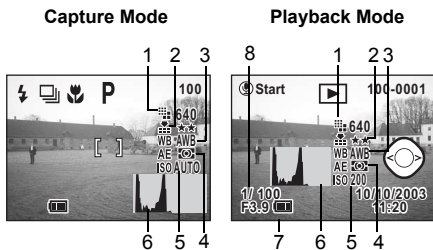

How to recall the [Y] Set-up] menu

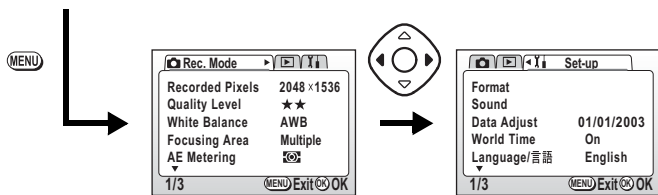
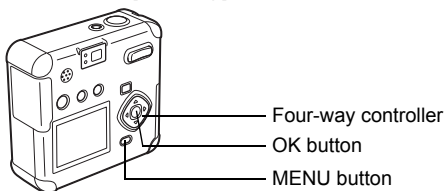

No. Info

Capture information is not displayed.

- During Autofocus, the Autofocus frame (in Capture mode) is displayed.
- Settings are displayed for several seconds when changed.

Capture Mode



Playback Mode



Off

Turns off the LCD monitor. (The LCD monitor is not turned off in Playback mode.)

Capture Mode



Playback Mode



- 1 Select [Display] on the [Y] Set-up] menu.**
- 2 Press the four-way controller (◀▶) to select the desired display mode.**
- 3 Press the OK button.**

The camera is ready for capture or playback.

Changing the Start-up Screen

You can display an image recorded with the camera as the welcome screen when the camera is turned on.

1 Select [Screen Setting] on the [Set-up] menu.

2 Press the four-way controller (▶).

The Screen Setting screen will be displayed.

3 Press the four-way controller (▶).

The screen for changing the start-up screen will be displayed.

4 Press the four-way controller (◀▶) to select (On) or (Off).

Displays the start-up screen.

Does not display the start-up screen.

5 Press the  button.

6 Use the four-way controller (◀▶) to select the image you want to display as the start-up screen.

7 Press the OK button 4 times.

The camera is ready for capture or playback.

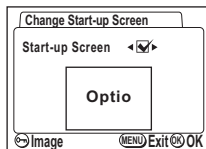

Once the start-up screen has been set, it will not be erased even if the original image is deleted or the SD Memory Card / MultiMediaCard is formatted. To delete the start-up screen, reset the setting. (p.99)

How to recall the [Y] Set-up] menu

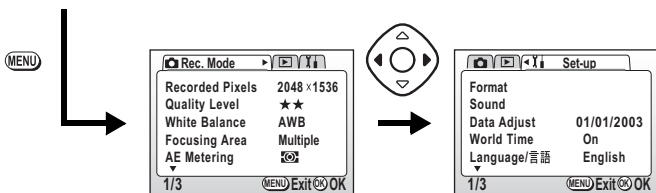
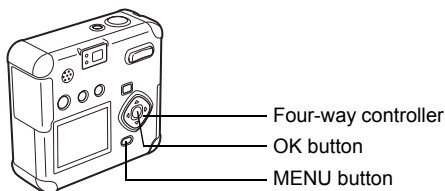

Setting the Background Color

This sets the background design and color displayed on the LCD monitor.

- 1 Select [Screen Setting] on the [Y] Set-up] menu.**
- 2 Press the four-way controller (▶).**
The Screen Setting screen will be displayed.
- 3 Press the four-way controller (▼) to select [Background color].**
- 4 Press the four-way controller (◀▶) to select the background color.**
- 5 Press the OK button twice.**
The camera is ready for capture or playback.

Selecting the Video Output Format

You can select the output format (NTSC or PAL) for capturing or playing back images on a TV monitor.

- 1 Select [Video Out] on the [F4 Set-up] menu.**
- 2 Press the four-way controller (◀▶) to select [NTSC] or [PAL], to match your TV output format.**
- 3 Press the OK button.**

The camera is ready for capture or playback.



Japan uses NTSC.

Setting Auto Power Off

You can set the camera to turn off automatically after a certain length of inactivity.

- 1 Select [Auto Power Off] on the [F4 Set-up] menu.**
- 2 Press the four-way controller (◀▶) to select [3 min], [5min], or [Off].**
- 3 Press the OK button.**

The camera is ready for capture or playback.



The Auto Power Off function will not work when the USB cable is connected.

Resetting to Default Settings [Reset]

This resets all settings other than Date/Time, Language, Video Out, Date Style, and World Time.

- 1 Select [Reset] on the [F4 Set-up] menu.**
- 2 Press the four-way controller (▶).**
The Reset screen is displayed.
- 3 Press the four-way controller (▲) to select [Reset].**
- 4 Press the OK button.**

The camera is ready for capture or playback.

Setting the Alarm

You can set the alarm to ring at a specified time and display a selected image.

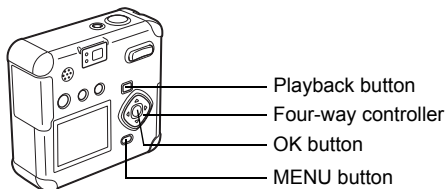

Checking the Alarm

1 Press the MENU button.

2 Press the four-way controller (▶).

The [▶ Playback] menu will be displayed.

3 Press the four-way controller (▲▼) to select [Alarm].

4 Press the four-way controller (▶).

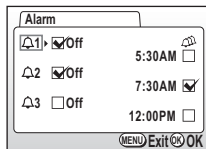

The list of alarms will be displayed.
Active alarms are indicated by .



5 Press the OK button twice.

If any alarms are enabled, the camera will be turned off and the alarms will be set.

Setting the Alarm

- 1 Press the MENU button.**
- 2 Press the four-way controller (▶).**
The [▶ Playback] menu will be displayed.
- 3 Press the four-way controller (▲▼) to select [Alarm].**
- 4 Press the four-way controller (▶).**
The list of alarms will be displayed.
- 5 Press the four-way controller (▲▼) to select alarm 1, 2, or 3.**
- 6 Press the four-way controller (▶).**
The screen for setting the alarm mode and time will be displayed.
- 7 Press the four-way controller (▲▼) to select the number of times the alarm will ring.**
Everyday The alarm will ring everyday at the set time.
Once The alarm rings once at the set time.
Off The alarm will not ring.
- 8 Press the four-way controller (▶).**
- 9 Press the four-way controller (▲▼) to set the time (hour) the alarm will ring.**
- 10 Repeat steps 8 and 9 above to set the alarm time (minute) and set  (Snooze) to (On) or (Off).**
If the Snooze is set to , the alarm will ring 5 times at 5-minute intervals.
- 11 Press the  button.**
- 12 Press the four-way controller (◀▶) to select the image to be displayed when the alarm rings.**
- 13 Press the OK button.**
- 14 Press the OK button 3 times.**
The camera will turn off.

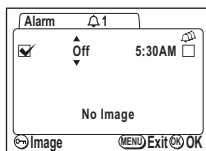
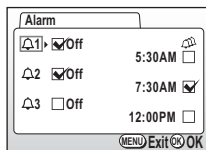

When the camera is turned off and the set time is reached, the alarm will ring for one minute. After the alarm turns off, the camera will turn off automatically.

Turning the Alarm Off

1 To stop the alarm ringing, press any button.

The alarm will stop.



To cancel the Snooze function, press the MENU button and OK button at the same time.



The alarm will not ring when the camera is turned on.

List of City Names

There are the cities and code numbers available for setting the world time.

City	Code	City	Code
Tokyo	TYO	Johannesburg	JNB
Guam	GUM	Istanbul	IST
Sydney	SYD	Cairo	CAI
Noumea	NOU	Jerusalem	JRS
Wellington	WLG	Moscow	MOW
Auckland	AKL	Jeddah	JED
Pagopago	PPG	Tehran	THR
Honolulu	HNL	Dubai	DXB
Anchorage	ANC	Karachi	KHI
Vancouver	YVR	Kabul	KBL
San Francisco	SFO	Male	MLE
Los Angeles	LAX	Delhi	DEL
Calgary	YYC	Colombo	CMB
Denver	DEN	Kathmandu	KTM
Mexico City	MEX	Dacca	DAC
Chicago	CHI	Rangoon	RGN
Miami	MIA	Bangkok	BKK
Toronto	YTO	Kuala Lumpur	KUL
New York	NYC	Vientiane	VTE
Santiago	SCL	Singapore	SIN
Caracas	CCS	Phnom Penh	PNH
Halifax	YHZ	Ho chi Minh	SGN
Buenos Aires	BUE	Jakarta	JKT
Sao Paulo	SAO	Hong Kong	HKG
Rio de Janeiro	RIO	Perth	PER
Madrid	MAD	Beijing	BJS
London	LON	Shanghai	SHA
Paris	PAR	Manila	MNL
Milano	MIL	Taipei	TPE
Rome	ROM	Seoul	SEL
Berlin	BER	Adelaide	ADL

Messages

The following messages may be displayed on the LCD monitor during camera operation.

Compression error	Compression of the image you captured has failed. Change the recorded pixels or quality level, and take a picture again.
Memory card full	The SD Memory Card / MultiMediaCard memory is full and no more images or sound can be saved. Insert a new SD Memory Card / MultiMediaCard or delete unwanted images or sound. (p.16, 77) You may be able to save the image by changing the quality level or recorded pixels. (p.40, 41)
Data being recorded	The image/voice recording is being recorded on the SD Memory Card / MultiMediaCard.
Image folder could not be created	The maximum file number has been used, and no more images or sound can be saved. Insert a new SD Memory Card / MultiMediaCard or format the card. (p.16, 90)
No image & sound	There are no images or sound saved in the SD Memory Card / MultiMediaCard that can be played back.
Camera cannot display this image	You are trying to play back an image not supported by this camera. You may be able to display this on a PC or another brand of camera.
Image protected	This is displayed when you try to delete a protected image.
Setting being recorded	The image/sound protect settings or DPOF settings are being changed.
Settings not stored	The SD Memory Card / MultiMediaCard is full, and no more DPOF settings can be made. Delete any unwanted images or sound and try to make the settings again.
Alarm was set	This is displayed when the alarm is set and the camera is about to be automatically turned off.
Deleting	An images or sound on the SD Memory Card / MultiMediaCard is being deleted.
Battery depleted	The battery is exhausted. Replace the battery. (p.12)
Memory card error	Shooting and playback are impossible due to a problem with the SD Memory Card / MultiMediaCard. Try displaying it on a PC.
Card not formatted	The SD Memory Card / MultiMediaCard you have inserted is unformatted or has been formatted on a PC or other device and is not compatible with the camera. (p.90)
Formatting	The SD Memory Card / MultiMediaCard is being formatted.
No card in camera	An SD Memory Card / MultiMediaCard has not been inserted into the camera. (p.16)
Card locked	The SD Memory Card is write protected. (p.18)

Optional Accessories

The following optional accessories are available for this camera.









AC Adapter D-AC5

USB Cable I-USB7 (included)

AV Cable I-AVC7 (included)

Troubleshooting

Problem	Cause	Remedy
The camera will not turn on.	No batteries are installed.	Check whether battery is installed. If not, install battery.
	Battery/card cover is open.	Close the battery/card cover.
	Battery is installed incorrectly.	Check orientation of battery.Reinsert battery according to the ⊕⊖ symbols in the battery compartment.(p.12)
	Battery is exhausted.	Install new batteries in the camera or use the AC adapter.
No image on the LCD monitor	Camera is connected to PC with USB cable.	The LCD monitor is always turned off when the camera is connected to a PC.
	Camera is connected to TV.	The LCD monitor is always turned off when the camera is connected to a TV.
	Image is displayed but hard to see.	Images on the LCD monitor may be hard to see when taking pictures outside in sunlight.
Shutter release button will not work.	Flash is charging.	While the flash status lamp is blinking red, the flash is being charged and a picture cannot be taken.The lamp lights red when charging is complete.
	SD Memory Card / MultiMediaCard is full.	Insert an SD Memory Card / MultiMediaCard that is not full, or delete unwanted images.(p.16, 77)
	Camera is recording.	Please wait until recording is finished.

Problem	Cause	Remedy
Out of focus	Subject is difficult for Autofocus to handle.	Subjects difficult for Autofocus include those with low contrast (blue skies, white walls), dark objects, fine-patterned objects, fast-moving objects, and landscapes seen through a window or net. Focus on something at the same distance as your subject, lock the focus (by pressing shutter release button halfway), aim at your subject, and press shutter release button fully.
	Subject is not in Focusing Area	Position focusing target within the frame (Focusing Area) at the center of the LCD screen. If your subject is not within the Focusing area, first focus on your subject within the AF area, lock the focus (by pressing shutter release button halfway), then reframe your picture as desired, and press shutter release button fully.
	Subject is too close.	Set the focus mode to  . (p.37)
	The focus mode is set to  .	When the focus mode is set to  , normal range pictures will be out of focus.
Picture is dark.	Subject is too far away in a dark environment (night-scenes, etc.).	If the subject is too far away, the image will be dark. Take the picture within the flash range.
	Background is dark.	When taking a picture of a person against a dark background, the person may appear clearly while the background appears dark because the flash does not reach the background. If you select the  or  mode on the virtual dial screen, both the person and the night-scene will be clear. (p.50)
Flash does not fire.	The Flash Mode is set to Off.	Set to Auto or  (p.39)
	The Capture mode is set to  , Continuous Shooting, or  mode or the Flash mode is set to  .	The flash will not fire in these modes.

Main Specifications

Model	Fully-automatic compact weather-resistant (JIS class 5) digital still camera with housed zoom lens
Effective Pixels	3.2 megapixels
Sensor	3.34 megapixels (total pixels), 1/2.7 inch interline transfer CCD with a primary color filter
Recorded Pixels	Still 2048x1536 pixels, 1600x1200 pixels, 1024x768 pixels, 640x480 pixels Movie picture 320x240 pixels, 160x240 pixels
Sensitivity	Auto, Manual (Equivalent to ISO50, ISO100, ISO200, and ISO400)
File Format	Still JPEG (Exif2.2), DCF, DPOF, PRINT Image Matching II Movie picture MOV (QuickTime Motion JPEG), about 15fps
Quality Level	Best, Better, Good
Storage Medium	SD Memory Card, MultiMediaCard

Image Storage Capacity

Quality Level Recorded Pixels	Best	Better	Good	Movie picture (320x240)	Movie picture (160x120)	Voice recording
2048x1536	7	12	18	40sec.	150sec.	30min.
1600x1200	11	20	27			
1024x768	25	45	56			
640x480	53	82	100			

- Exposure capacity when using a 16MB SD Memory Card.

White Balance	Auto, Daylight, Shade, Tungsten Light, Fluorescent light, Manual	
Lens	Focal Length	5.7mm - 16mm (Equivalent to 37 - 104mm in 35mm format)
	Max. aperture	f/2.8 - f/3.9
	Lens Composition	10 elements in 7 groups (one lens aspherical on both sides)
	Zoom Type	Electrically driven
	Capture Range	16.8mm x 12.4mm (full screen) (Using macro mode or manual focus at max. WIDE position)
Digital Zoom	Capture Mode	Max 4x (Combines with 2.8x optical zoom to provide zoom equivalent to 11.2x max.)
Viewfinder	Type	Real optical zoom viewfinder
	Magnification	Wide 0.3x, Tele 0.71x
LCD monitor	1.6-inch 1.6TFT color LCD, 84 kilomegapixels	
Playback Functions	Single-frame, 9-frame index, zoom (max. 8x), scroll, slideshow, movie playback, sound playback, histogram display, trimming, resize, digital filters	

Autofocus system	Type	TTL contrast detection by sensor
	Capture Range (From lens front)	Normal: 0.3m - ∞ (full zoom range) Macro: 0.01m - 0.5m (Wide), 0.2m - 0.5m (Tele) (full zoom range) Infinity-landscape: ∞ (full zoom range)
	Focus Lock	By pressing the shutter release button halfway
Manual Focus	0.01m - ∞ (Wide), 0.2m - ∞ (Tele)	
Exposure Mechanism	AE Metering	TTL metering by sensor (multi-segment, center-weighted, spot)
	Exposure Modes	Program, Picture mode, Movie Picture, Panorama Assist, Voice Recording
	EV Compensation	±2EV (Can be set in 1/3EV steps)
	Movie Picture	Recording time by vacant memory
Shutter	Model	Electronic/Mechanical shutter
	Speed	Approx. 1/2000 sec - 4 sec.
Flash	Model	Automatic flash with red-eye reduction function
	Flash Modes	Auto, Flash Off, Flash On, Auto+Red-eye reduction, Flash On+Red-eye reduction
	Capture Range	Wide Approx. 0.1m - 2.9m w/Sensitivity AUTO Tele Approx. 0.5m - 2.1m w/Sensitivity AUTO
Drive Modes	Single-frame Shooting, Self-timer Shooting, Continuous Shooting, Multi Continuous Shooting, Interval Shooting	
Self-timer	Electrically controlled, operation time approx. 10 seconds	
Time function	World Time settings for 62 cities (28 time zones)	
Power Supply	Lithium battery CR-V3, two AA batteries (Alkaline, Ni-MH, Lithium), AC Adapter (optional)	
Battery Life	Approx. 540 images	(with 50% of shooting using flash, and using lithium battery CR-V3) Note: Based on PENTAX measuring conditions.
I/O Ports	USB/AV terminal (PC communication USB1.1), external power supply terminal	
Video Output Format	NTSC/PAL	
Size	81.5 (W) × 76 (H) × 30.5 (D) mm (excluding protruding parts)	
Weight	160 g (excluding batteries and SD Memory Card / MultiMediaCard)	
Weight when shooting	208 g (including batteries and SD Memory Card / MultiMediaCard)	
Accessories	AA batteries (2), AV cable, USB cable, software (CD-ROM), strap, 16MB SD Memory Card, operating manual, warranty	
Water resistant	Equivalent to JIS Class 5 and 7	

WARRANTY POLICY

All PENTAX cameras purchased through authorized bona fide photographic distribution channels are guaranteed against defects of material or workmanship for a period of twelve months from date of purchase. Service will be rendered, and defective parts will be replaced without cost to you within that period, provided the equipment does not show evidence of impact, sand or liquid damage, mishandling, tampering, battery or chemical corrosion, operation contrary to operating instructions, or modification by an unauthorized repair shop. The manufacturer or its authorized representatives shall not be liable for any repair or alterations except those made with its written consent and shall not be liable for damages from delay or loss of use or from other indirect or consequential damages of any kind, whether caused by defective material or workmanship or otherwise; and it is expressly agreed that the liability of the manufacturer or its representatives under all guarantees or warranties, whether expressed or implied, is strictly limited to the replacement of parts as hereinbefore provided. No refunds will be made on repairs by nonauthorized PENTAX service facilities.

Procedure During 12-month Warranty Period

Any PENTAX which proves defective during the 12-month warranty period should be returned to the dealer from whom you purchased the equipment or to the manufacturer. If there are no representatives of the manufacturer in your country, send the equipment to the manufacturer, with postage prepaid. In this case, it will take a considerable length of time before the equipment can be returned to you owing to the complicated customs procedures required. If the equipment is covered by warranty, repairs will be made and parts replaced free of charge, and the equipment will be returned to you upon completion of servicing. If the equipment is not covered by warranty, regular charges of the manufacturer or of its representatives will apply. Shipping charges are to be borne by the owner. If your PENTAX was purchased outside of the country where you wish to have it serviced during the warranty period, regular handling and servicing fees may be charged by the manufacturer's representatives in that country. Notwithstanding this, your PENTAX returned to the manufacturer will be serviced free of charge according to this procedure and warranty policy. In any case, however, shipping charges and customs clearance fees to be borne by the sender. To prove the date of your purchase when required, please keep the receipt or bills covering the purchase of your equipment for at least a year. Before sending your equipment for servicing, please make sure that you are sending it to the manufacturer's authorized representatives or their approved repair shops, unless you are sending it directly to the manufacturer.

Always obtain a quotation for the service charge, and only after you accept the quoted service charge, instruct the service station to proceed with the servicing.

- **This warranty policy does not affect the customer's statutory rights.**
- **The local warranty policies available from PENTAX distributors in some countries can supersede this warranty policy. Therefore, we recommend that you review the warranty card supplied with your product at the time of purchase, or contact the PENTAX distributor in your country for more information and to receive a copy of the warranty policy.**



The CE Mark is a Directive conformity mark of the European Community.

For customers in USA**STATEMENT OF FCC COMPLIANCE**

This device complies with Part 15 of the FCC Rules. Operation is subject to the following two conditions: (1) This device may not cause harmful interference, and (2) this device must accept any interference received, including interference that may cause undesired operation. Changes or modifications not approved by the party responsible for compliance could void the user's authority to operate the equipment.

This equipment has been tested and found to comply with the limits for a Class B digital device, pursuant to part 15 of the FCC Rules.

These limits are designed to provide reasonable protection against harmful interference in a residential installation. This equipment generates, uses and can radiate frequency energy and, if not installed and used in accordance with the instructions, may cause harmful interference to radio communications. However, there is no guarantee that interference will not occur in a particular installation.

If this equipment does cause harmful interference to radio or television reception, which can be determined by turning the equipment off and on, the user is encouraged to try to correct the interference by one or more of the following measures:

Reorient or relocate the receiving antenna.

Increase the separation between the equipment and receiver.

Connect the equipment into an outlet on a circuit different from that to which the receiver is connected.

Consult the dealer or an experienced radio/TV technician for help.

For customers in Canada

This Class B digital apparatus meets all requirements of the Canadian Interference - Causing Equipment Regulations.

Pour les utilisateurs au Canada

Cet appareil numérique de la classe B respecte toutes les exigences du Règlement sur le matériel brouilleur du Canada.

The CE Mark is a Directive conformity mark of the European Community.

Declaration of Conformity
According to 47CFR, Parts 2 and 15 for
Class B Personal Computers and Peripherals

We: PENTAX U.S.A., Inc.

Located at: 600 12th Street, Suite 300,
Golden, Colorado 80401, U.S.A
Phone: 303-799-8000 FAX: 303-790-1131

Declare under sole responsibility that the product identified herein, complies with 47CFR Parts 2 and 15 of the FCC rules as a Class B digital device. Each product marketed, is identical to the representative unit tested and found to be compliant with the standards. Records maintained continue to reflect the equipment being produced can be expected to be within the variation accepted, due to quantity production and testing on the statistical basis as required by 47CFR §2.909. Operation is subject to the following two conditions: (1) This device may not cause harmful interference, and (2) This device must accept any interference received, including interference that may cause undesired operation. The above named party is responsible for ensuring that the equipment complies with the standards of 47CFR §15.101 to §15.109.

Product Name: PENTAX Digital Still Camera

Model Number: Optio 33WR

Contact person: Customer Service Manager

Date and Place: August, 2003, Colorado

PENTAX Corporation	2-36-9, Maeno-cho, Itabashi-ku, Tokyo 174-8639, JAPAN (http://www.pentax.co.jp/)
PENTAX Europe GmbH (European Headquarters)	Julius-Vosseler-Strasse, 104, 22527 Hamburg, GERMANY (HQ - http://www.pentaxeurope.com) (Germany - http://www.pentax.de)
PENTAX U.K. Limited	PENTAX House, Heron Drive, Langley, Slough, Berks SL3 8PN, U.K. (http://www.pentax.co.uk)
PENTAX France S.A.S.	12/14, rue Jean Poulmarch, 95106 Argenteuil Cedex, FRANCE
PENTAX Benelux B.V.	(for Netherlands) Spinveld 25, 4815 HR Breda, NETHERLANDS (http://www.pentax.nl) (for Belgium & Luxembourg) Weiveldlaan 3-5, 1930 Zaventem, BELGIUM (http://www.pentax.be)
PENTAX (Schweiz) AG	Widenholzstrasse 1 Postfach 367 8305 Dietlikon, SWITZERLAND (http://www.pentax.ch)
PENTAX Scandinavia AB	P.O. Box 650, 75127 Uppsala, SWEDEN (http://www.pentax.se)
PENTAX U.S.A., Inc	600 12th Street, Suite 300, Golden, Colorado 80401, U.S.A (http://www.pentax.com)
PENTAX Canada Inc.	3131 Universal Drive, Mississauga, Ontario L4X 2E5, CANADA (http://www.pentaxcanada.ca)



for your
precious moments

- Printed on recycled paper
- Specifications and external dimensions are subject to change without notice.

Free Manuals Download Website

<http://myh66.com>

<http://usermanuals.us>

<http://www.somanuals.com>

<http://www.4manuals.cc>

<http://www.manual-lib.com>

<http://www.404manual.com>

<http://www.luxmanual.com>

<http://aubethermostatmanual.com>

Golf course search by state

<http://golfingnear.com>

Email search by domain

<http://emailbydomain.com>

Auto manuals search

<http://auto.somanuals.com>

TV manuals search

<http://tv.somanuals.com>