

# PENTAX



Medium Format Digital SLR Camera

# 645D

## Operating Manual

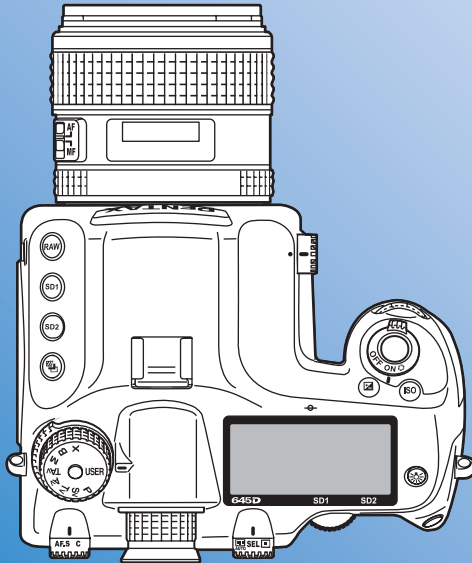

To ensure the best performance from your camera,  
please read the operating manual before using the camera.

Thank you for purchasing this PENTAX medium format digital SLR camera **645D**. Please read this manual before using the camera in order to get the most out of all the features and functions. Keep this manual safe, as it can be a valuable tool in helping you to understand all the camera's capabilities.

### Lenses you can use

In general, lenses that can be used with this camera are D FA645 and FA645 lenses, and 645 lenses that have an Aperture **A** (Auto) position. To use any other lens or accessory, see p.26 of this manual.

### Regarding copyrights

Images taken with this camera that are for anything other than personal enjoyment cannot be used without permission according to the rights as specified in the Copyright Act. Please take care, as there are cases where limitations are placed on taking pictures even for personal enjoyment during demonstrations, performances or of items on display. Images taken with the purpose of obtaining copyrights also cannot be used outside the scope of use of the copyright as laid out in the Copyright Act, and care should be taken here also.

### Regarding trademarks

Microsoft and Windows are registered trademarks of Microsoft Corporation in the United States and other countries. Windows Vista is either a registered trademark or trademark of Microsoft Corporation in the United States and/or other countries.

Macintosh and Mac OS are trademarks of Apple Inc., registered in the U.S. and other countries.



SDHC Logo is a trademark of SD-3C, LLC.

This product includes DNG technology under license by Adobe Systems Incorporated.



The DNG logo is either registered trademarks or trademarks of Adobe Systems Incorporated in the United States and/or other countries.

**HDMI**, the HDMI logo and High-Definition Multimedia Interface are trademarks or registered trademarks of HDMI Licensing LLC.

All other brands or product names are trademarks or registered trademarks of their respective companies.

This product supports PRINT Image Matching III. PRINT Image Matching enabled digital still cameras, printers and software help photographers to produce images more faithful to their intentions. Some functions are not available on printers that are not PRINT Image Matching III compliant.

Copyright 2001 Seiko Epson Corporation. All Rights Reserved. PRINT Image Matching is a trademark of Seiko Epson Corporation. The PRINT Image Matching logo is a trademark of Seiko Epson Corporation.

### To users of this camera

- Do not use or store this device in the vicinity of equipment that generates strong electromagnetic radiation or magnetic fields. Strong static charges or the magnetic fields produced by equipment such as radio transmitters could interfere with the monitor, damage the stored data, or affect the product's internal circuitry and cause camera misoperation.
- The liquid crystal panel used for the monitor is manufactured using extremely high precision technology. Although the level of functioning pixels is 99.99% or better, you should be aware that 0.01% or fewer of the pixels may not illuminate or may illuminate when they should not. However, this has no effect on the recorded image.
- In this manual, both an SD Memory Card and an SDHC Memory Card are referred to as SD Memory Cards hereafter.
- In this manual, the generic term "computer(s)" refers to either a Windows PC or a Macintosh hereafter.
- In this manual, the term "battery(ies)" refers to any type of batteries used for this camera and accessories.

There is a possibility that the illustrations and the display screen in this manual are different from the actual product.

## FOR USING YOUR CAMERA SAFELY

We have paid close attention to the safety of this product. When using this product, we request your special attention regarding items marked with the following symbols.



### Warning

This symbol indicates that violating this item could cause serious personal injuries.



### Caution

This symbol indicates that violating this item could cause minor or medium personal injuries, or loss of property.

## ABOUT THE CAMERA



### Warning

- Do not disassemble or modify the camera. High voltage areas are present inside the camera, with the risk of electric shock.
- If the camera interior is exposed due to dropping or otherwise damaging the camera, never touch the exposed portion. There is a risk of electric shock.
- Wrapping the strap around your neck is dangerous. Take care that small children do not hang the strap around their necks.
- Do not look directly at the sun through the camera with a telephoto lens attached, as viewing the sun may damage your eyes. Viewing the sun directly with a telephoto lens may lead to a loss of eyesight.
- If any irregularities occur during use, such as smoke or a strange odor, stop use immediately, remove the battery or the AC adapter, and contact your nearest PENTAX Service Center. Continuing to use the product can cause a fire or electric shock.

- Some portions of the camera heat up during use. There is a risk of low temperature burns when holding such portions for long periods.
- Should the monitor be damaged, be careful of glass fragments. Also, be careful not to allow the liquid crystal to get on your skin or in your eyes or mouth.
- Depending on your individual factors or physical condition, the use of the camera may cause itching, rashes or blisters. In case of any abnormality, stop using the camera and get medical attention immediately.

## About the Battery Charger and AC Adapter



### Warning

- Always use the battery charger and AC adapter exclusively developed for this product, with the specified power and voltage. Using a battery charger or AC adapter not exclusive to this product, or using the exclusive battery charger or AC adapter with an unspecified power or voltage can cause a fire, electric shock, or camera breakdown. The specified voltage is 100 - 240V AC.
- Do not disassemble or modify the product. This can cause a fire or electric shock.
- If the generation of smoke or strange odor from the product or other abnormality occurs, immediately discontinue use and consult a PENTAX Service Center. Continuing to use the product can cause a fire or electric shock.
- If water should happen to get inside the product, consult a PENTAX Service Center. Continuing to use the product can cause a fire or electric shock.
- If a thunder storm should occur while using the battery charger and AC adapter, unplug the AC plug cord and discontinue use. Continuing to use the product can cause damage to the equipment, fire or electric shock.

- Wipe off the plug of the AC plug cord if it becomes covered with dust. Dust on the plug may cause a fire.

### **Caution**

- Do not place or drop heavy objects on or forcefully bend the AC plug cord. Doing so may damage the cord. Should the AC plug cord be damaged, consult a PENTAX Service Center.
- Do not touch or short-circuit the terminal area of the AC plug cord while the cord is plugged in.
- Do not plug or unplug the power cord with wet hands. This can cause an electric shock.
- Do not drop the product, or subject it to violent impact. This can cause equipment breakdown.
- Do not use the battery charger to charge a battery other than a rechargeable lithium-ion battery D-LI90. Attempting to charge other types of batteries may cause an explosion, or heating, or may damage the battery charger.
- To reduce the risk of hazards, use only a CSA/UL certified power supply cord set, cord is Type SPT-2 or heavier, minimum NO.18 AWG copper, one end with a molded-on male attachment plug cap (with a specified NEMA configuration), and the other is provided with a molded-on female connector body (with a specified IEC nonindustrial type configuration) or the equivalent.

## About the Battery

### **Warning**

- Be sure to store the battery out of the reach of small children. Placing it in their mouths may cause an electric shock.
- If any leakage from the battery should come in contact with your eyes, do not rub them. Flush your eyes with clean water and get medical attention immediately.

### **Caution**

- Only use the specified battery with this camera. Use of other batteries may cause an explosion or fire.
- Do not disassemble the battery. Disassembling the battery may cause an explosion or leakage.
- Remove the battery from the camera immediately if it becomes hot or begins to smoke. Be careful not to burn yourself during removal.
- Keep wires, hairpins, and other metal objects away from the + and - contacts of the battery.
- Do not short the battery or dispose of the battery in fire. This can cause an explosion or fire.
- If any leakage from the battery should come in contact with skin or clothes, wash the affected areas thoroughly with water.
- Precautions for D-LI90 Battery Usage:  
USE SPECIFIED CHARGER ONLY.  
DO NOT INCINERATE.  
DO NOT DISASSEMBLE.  
DO NOT SHORT CIRCUIT.  
DO NOT EXPOSE TO HIGH TEMP. (140°F/60°C)

## About the SD Memory Card

### **Warning**

- Be sure to store the SD Memory Card out of the reach of small children. The SD Memory Card may be swallowed by mistake. Seek medical attention immediately if a memory card is accidentally swallowed.

## Care to be Taken During Handling

### Before Using Your Camera

- When the camera has not been used for a long time, confirm that it is still working properly, particularly prior to taking important pictures (such as at a wedding or when traveling). Recorded data cannot be guaranteed if recording, playback or transferring your data to a computer, etc. is not possible due to a malfunction of your camera or recording media (SD Memory Card), etc.

### About the Battery and Charger

- Storing the battery fully charged may decrease the battery performance. Avoid storing in high temperatures.
- If the battery is left inserted and the camera is not used for a long time, the battery will over-discharge and shorten the battery's usage span.
- Charging the battery a day before use or on the day of use is recommended.
- The AC plug cord provided with this camera is developed exclusively for the battery charger D-BC90. Do not use it with other devices.

## Precautions on Carrying and Using Your Camera

- Do not subject the camera to high temperatures or high humidity. Do not leave the camera in a vehicle, as the temperature can get very high.
- Do not subject the camera to strong vibrations, shocks, or pressure. Use a cushion to protect the camera from vibrations of motorcycles, automobiles, or ships.
- The temperature range for camera use is  $-10^{\circ}\text{C}$  to  $40^{\circ}\text{C}$  ( $14^{\circ}\text{F}$  to  $104^{\circ}\text{F}$ ).
- The monitor may appear black at high temperatures, but will return to normal at normal temperatures.
- The monitor may respond more slowly at low temperatures. This is due to liquid crystal properties, and is not a malfunction.
- Sudden temperature changes will cause condensation on the inside and outside of the camera. Place the camera in your bag or a plastic bag, and remove it after temperature of the camera and surroundings are equalized.
- Avoid contact with garbage, mud, sand, dust, water, toxic gases, or salts. These could cause the camera to breakdown. Wipe the camera to dry off any rain or water drops.
- Please do not press forcefully on the monitor. This could cause it to break or malfunction.
- Be careful not to overtighten the tripod screw when using a tripod.

## Cleaning Your Camera

- Do not clean the product with organic solvents such as thinner, alcohol or benzine.
- Use a lens brush to remove dust accumulated on the lens or viewfinder. Never use a spray blower for cleaning as it may damage the lens.
- Please contact PENTAX Service Center for professional cleaning of CCD Sensor. (This service will involve a fee.)

## Storing Your Camera

- Do not store the camera with preservatives or chemicals. Storage in high temperatures and high humidity can cause mold to grow on the camera. Remove the camera from its case and store it in a dry and well-ventilated location.

## Other Precautions

- Periodic inspections are recommended every one to two years to maintain high performance.
- Refer to “Precautions When Using the SD Memory Card” (p.32) regarding the SD Memory Card.
- Please note that deleting images or formatting the SD Memory Cards does not completely erase the original data. Deleted files can sometimes be recovered using commercially available software. It is user’s responsibility to ensure the privacy.

### Regarding Product Registration

In order to better serve you, we request that you complete the product registration, which can be found on the CD-ROM supplied with the camera or the PENTAX website. Thank you for your cooperation. Refer to “Using a Computer” (p.81) for more information.

# Provided Manuals

---

This camera comes with two manuals: “Operating Manual” (this book) and “Menu Reference”. Use these as needed.



## Operating Manual

Describes the necessary preparations before use and the basic operations of your camera. The “Operating Manual” contains pages 1 to 103.

## Menu Reference

Describes the functions that can be set when the **MENU** button is pressed and the product specifications. After you read the “Operating Manual” and become familiar with the basic operations of your camera, you can carry the “Menu Reference” with you as a handy reference guide. The “Menu Reference” contains pages R1 to R48.

The following symbols indicate reference page numbers with related information.

-  Refer to another location within the same document.
-  Refer to a location in the other document.

# Operating Manual Contents

FOR USING YOUR CAMERA SAFELY .....	1
Care to be Taken During Handling .....	3
<b>Provided Manuals .....</b>	<b>5</b>
<b>1 Before Using Your Camera .....</b>	<b>9</b>
Checking the Contents of the Package.....	10
Names and Functions of Working Parts .....	11
Buttons and Dials.....	12
Display Indicators .....	14
Monitor.....	14
Viewfinder and LCD Panel.....	20
<b>2 Getting Started .....</b>	<b>23</b>
Attaching the Strap.....	24
Attaching the Lens.....	24
Lens Compatibility Chart.....	26
Using the Battery .....	28
Charging the Battery.....	28
Inserting/Removing the Battery .....	28
Using the AC Adapter (Optional) .....	30
Inserting/Removing the SD Memory Card .....	31
Power .....	33
Initial Settings .....	34
Language Setting.....	34
Date Adjustment .....	35
Formatting an SD Memory Card.....	36
Diopter Adjustment.....	37
Attaching the Large Eyecup.....	37

<b>Testing Your Camera .....</b>	<b>37</b>
Shooting .....	37
Playing Back Captured Images .....	38
<b>How to Change Function Settings.....</b>	<b>38</b>
Using the Direct Keys.....	38
Using the Control Panel .....	39
Using the Menus .....	40

<b>3 Shooting Functions .....</b>	<b>41</b>
<b>Setting the File Format and Data Saving Method .....</b>	<b>42</b>
File Format .....	42
JPEG Recorded Pixels/Quality Level .....	43
<b>Focusing .....</b>	<b>44</b>
Selecting the Focus Mode.....	44
AF Point Switching .....	44
<b>Exposure Setting.....</b>	<b>45</b>
Selecting the Metering Mode.....	45
Setting the Sensitivity .....	46
Changing the Exposure Mode.....	47
AE Lock .....	49
<b>White Balance.....</b>	<b>50</b>
Setting the Manual White Balance .....	51
Setting the Color Temperature .....	52
Saving the White Balance Setting of a Captured Image.....	52
<b>Drive Mode.....</b>	<b>53</b>
Continuous Shooting .....	53
Self-timer Shooting.....	54
Remote Control Shooting .....	54
Interval Shooting .....	54
Multi-exposure .....	55
Mirror Lock-up .....	55
<b>Auto Bracketing .....</b>	<b>56</b>
Exposure Bracketing .....	56
Extended Bracketing .....	57



<b>Flash Mode</b> .....	<b>58</b>
Attaching a Flash .....	58
Setting the Flash Mode .....	58
Flash Compatibility Chart .....	60
<b>Preview</b> .....	<b>61</b>
Optical Preview .....	61
Digital Preview .....	61
<b>Custom Image</b> .....	<b>62</b>

## 4 Playback and Processing Functions **65**

<b>Setting the Playback Functions</b> .....	<b>66</b>
Playback Mode Palette .....	66
<b>Displaying a Single Image</b> .....	<b>67</b>
Deleting Images One by One .....	67
Zoom Display .....	67
<b>Displaying Multiple Images</b> .....	<b>68</b>
Multi-image Display .....	68
Folder Display .....	69
Calendar Display .....	69
Slideshow .....	70
Image Comparison .....	70
Index .....	71
<b>Developing RAW Images</b> .....	<b>72</b>
<b>Protecting Images</b> .....	<b>73</b>
<b>Rotating Images</b> .....	<b>74</b>
<b>Changing the Image Size</b> .....	<b>75</b>
Resizing Images .....	75
Cropping Images .....	75
<b>Digital Filters</b> .....	<b>76</b>
Applying the Digital Filter .....	76
Recreating Filter Effects .....	77
Searching for the Original Image .....	77

<b>DPOF Settings</b> .....	<b>78</b>
<b>Connecting the Camera to AV Equipment</b> .....	<b>79</b>

## 5 Using a Computer **81**

<b>Connecting to a Computer</b> .....	<b>82</b>
System Requirements .....	82
Connecting Your Camera to a Computer .....	83
<b>Using the Provided Software</b> .....	<b>84</b>
Installing the Software .....	84
The PENTAX Digital Camera Utility 4 Screen .....	85
Viewing the Help Menu .....	87

## 6 Appendix **89**

<b>Optional Accessories</b> .....	<b>90</b>
<b>Error Messages</b> .....	<b>93</b>
<b>Troubleshooting</b> .....	<b>94</b>
<b>Index</b> .....	<b>95</b>
<b>WARRANTY POLICY</b> .....	<b>100</b>

# MEMO

# 1

## Before Using Your Camera

---

Checking the Contents of the Package .....	10
Names and Functions of Working Parts .....	11
Display Indicators .....	14

# Checking the Contents of the Package

The following accessories are packaged with the **645D**.  
Check that all accessories are included before using your camera.



Hot shoe cover Fk  
(Installed on camera)



Sync socket 2P cap  
(Installed on camera)



Standard eyecup  
(Installed on camera)



Large eyecup 645  
O-EC107

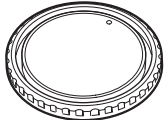

Body mount cap 645  
(Installed on camera)



Triangular ring and protective cover  
(Installed on camera)

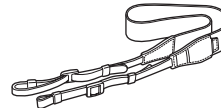

Strap  
O-ST107

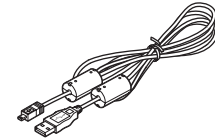

USB cable  
I-USB107



Rechargeable lithium-ion battery  
D-LI90

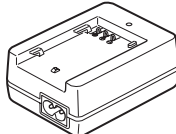

Battery charger  
D-BC90



AC plug cord

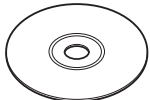

Software (CD-ROM)  
S-SW107



Operating Manual (this book)



Menu Reference

# Names and Functions of Working Parts

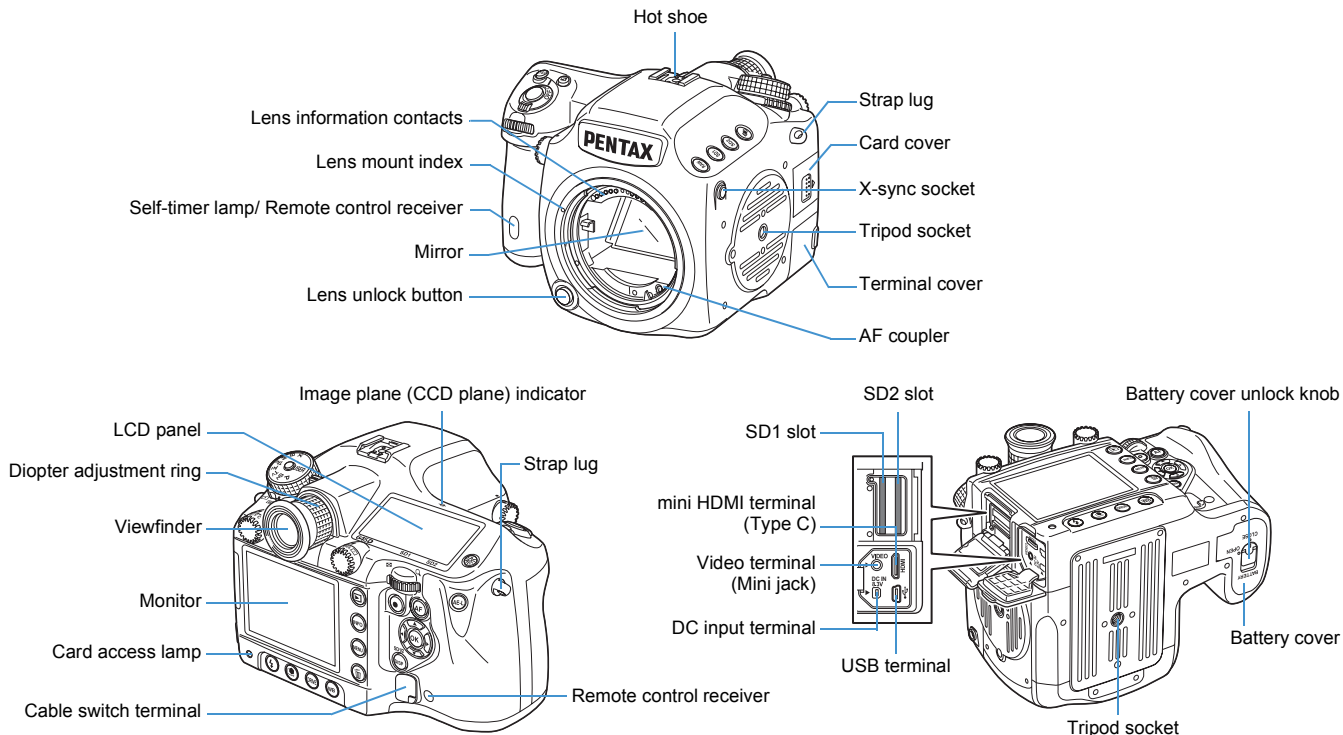

\* The front and rear views show the camera with the Hot shoe cover Fk removed.

## Caution

- Be sure to close the terminal cover correctly to keep out dust and moisture.

## Buttons and Dials

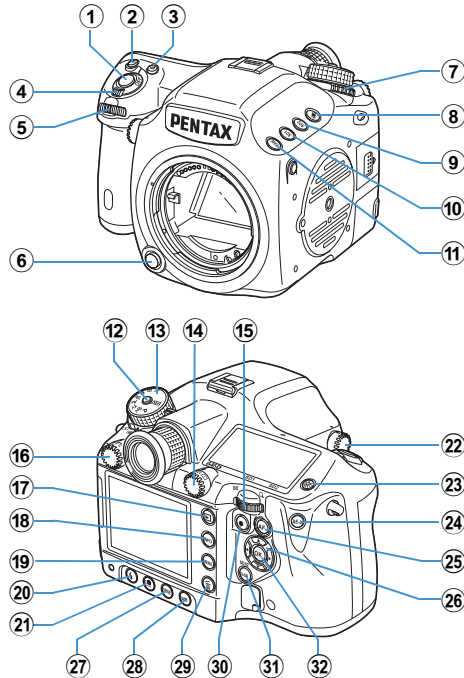

### ① Shutter release button

Press to capture images. (p.37)

Press halfway during playback to switch to Capture mode.

### ② ISO button

Turn the  dial while pressing this button to set the ISO sensitivity. (p.46)

### ③ (EV Compensation) button

Turn the  dial while pressing this button to set the EV compensation value. (p.48)

Press to increase the magnification in enlarged view during playback. (p.67)

### ④ Main switch

Move to turn the power on/off (p.33) or to preview (p.61).

### ⑤ (Front) e-dial

Changes setting values.

Displays the next or previous image during playback.

Switches between the menu categories when a menu is displayed. (p.40)

### ⑥ Lens unlock button

Press to detach a lens.

### ⑦ Metering mode switch

Switches between the metering modes. (p.45)

### ⑧ (Exposure Bracketing) button

Sets exposure bracketing. (p.56)



### ⑨ SD2 (SD2 quality level) button

Sets the file format for saving images to the SD Memory Card in the SD2 slot. (p.42)

### ⑩ SD1 (SD1 quality level) button

Sets the file format for saving images to the SD Memory Card in the SD1 slot. (p.42)

### ⑪ RAW button













Temporarily changes the file format. Set the file format in the  4 menu. ( p.R19)

### ⑫ Mode dial lock button





Press to allow the mode dial to be turned. (p.48)

### ⑬ Mode dial

Switches between the exposure modes. (p.48)

- 14 AF point switching dial**  
Sets the AF point. (p.44)
- 15  (Rear) e-dial**  
Changes setting values.  
Changes the magnification in enlarged view and displays multiple images during playback. (p.67, p.68)  
Switches between the menu tabs when a menu is displayed. (p.40)
- 16 AF mode switching dial**  
Switches between the autofocus modes (**AFS/C**). (p.44)
- 17  (Playback) button**  
Switches to the Playback mode. (p.38) Press again to switch to Capture mode.
- 18 INFO button**  
Displays the control panel. (p.16)  
Displays shooting information during playback. (p.17)
- 19 MENU button**  
Displays the []1 menu. (p.40) Next, press the  key to display other menus. Displays the []1 menu first during playback.  
When a menu is displayed, press this button to cancel a selection or return to the previous screen.
- 20  (Flash mode) button**  
Sets the flash mode. (p.58)
- 21  (Custom Image) button**  
Sets the Custom Image settings. (p.62)
- 22 MUP (Mirror Up) dial**  
Enables the mirror lock-up shooting. (p.55)
- 23  (Illumination) button**  
Illuminates the LCD panel. (p.22)
- 24 AE-L button**  
Locks the exposure. (p.49)
- Saves the preview image when setting White Balance or Custom Image. (p.50, p.62)
- 25 AF button**  
Operates in the same way as when pressing the shutter release button halfway and temporarily provides manual focus. (p.44, [p.R31](#))
- 26  (Four-way controller) keys**  
When the control panel or menu is displayed, use these keys to move the cursor or change items.  
When the AF point switching dial is set to **SEL** (Select), use these keys to change the AF point. (p.45)  
Press the  key to display the playback mode palette during playback. (p.66)
- 27 DRIVE button**  
Sets the drive mode. (p.53)
- 28 WB (White Balance) button**  
Sets the white balance. (p.50)
- 29  (Delete) button**  
Press to delete an image during playback. (p.67)
- 30  (Green) button**  
Sets the exposure mode to Automatic Exposure and resets the setting values.
- 31 DISP button**  
Turns the status screen display on/off. (p.15)  
Switches between the SD Memory Cards to play back during playback. (p.66)
- 32 OK button**  
When the control panel or menu is displayed, press this button to confirm the selected item.  
When the AF point switching dial is set to **SEL** (Select), use this button to return the AF point to the center. (p.45)

## Button and Dial Operations

You can operate both a button and e-dial, such as  and  or  and , to change the settings using either of the following methods.

Operation	Confirming the Setting
Turn the dial while pressing the button.	Take your finger off the button.
Press the button, take your finger off the button, and then turn the dial.	Press the button again or wait until the exposure lock timer goes off.



Hereafter, this Operating Manual explains by using the “Turn the dial while pressing the button” operation.

# Display Indicators

## Monitor

The following indicators appear on the monitor depending on the status of the camera.



### Memo

- You can adjust the brightness and color of the monitor with [Brightness Level] and [LCD Color Tuning] in the [2] menu. ( p.R24 - p.R25)

## At Start-up or when Operating the Mode Dial

Guide indicators appear on the monitor for 3 seconds (default setting) when the camera is switched on or the mode dial is turned.

### Memo

- To turn off the guide indicators, set [Guide Display] to [Off] in the [1] menu. ( p.R24)

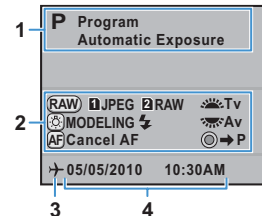



- 1 Exposure Mode (p.47)
- 2 Operation guide
- 3 World Time setting
- 4 Current date and time (p.35)

\* Indicator 3 appears only when [World Time] is set to [Destination] in the [1] menu. (p.R23)

## Capture Mode

### ● Status screen

Press the **DISP** button to display the settings of the shooting functions.

(All of the indications are displayed here for explanatory purposes. The actual display may differ.)

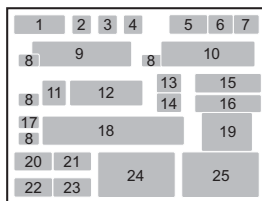
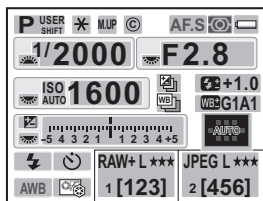

- 5 Exposure Mode (p.47)
- 6 AE lock (p.49)
- 7 Mirror Up (p.55)
- 8 Copyright Information embedded (p.R27)
- 9 AF mode (p.44)
- 10 Metering mode (p.45)
- 11 Battery level (p.29)
- 12 e-dial guide
- 13 Shutter speed
- 14 Aperture value
- 15 ISO/ISO AUTO
- 16 Sensitivity (p.46)
- 17 Exposure Bracketing (p.56)/ Multi-exposure (p.55)/HDR Capture (p.R16)
- 18 Extended Bracketing (p.57)
- 19 Flash Exposure Compensation (p.59)
- 20 White Balance fine tuning (p.51)
- 21 EV Compensation (p.48)
- 22 EV bar
- 23 AF point (p.44)
- 24 Flash Mode (p.58)
- 25 Drive Mode (p.53)
- 26 White Balance (p.50)
- 27 Custom Image (p.62)
- 28 SD1 Image File Format/JPEG Recorded Pixels/JPEG Quality/Remaining image storage capacity (p.42)
- 29 SD2 Image File Format/JPEG Recorded Pixels/JPEG Quality/Remaining image storage capacity (p.42)

### Memo

- The status screen will disappear if no operations are made within 30 seconds after pressing the **DISP** button.
- You can change the color of the status screen by setting [Status Screen] in the [3] menu. (p.R18)

## ● Control panel

Press the **INFO** button to display the control panel and change settings.

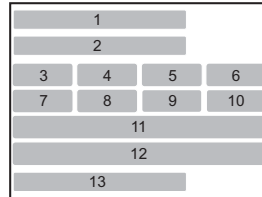
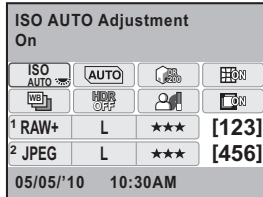

- |    |   |    |  |
|----|---|----|--|
| 1  | Function name                           | 11 | SD1 Image File Format/JPEG Recorded Pixels/JPEG Quality/Remaining image storage capacity |
| 2  | Setting                                 | 12 | SD2 Image File Format/JPEG Recorded Pixels/JPEG Quality/Remaining image storage capacity |
| 3  | ISO AUTO Adjustment                     | 13 | Current date and time  |
| 4  | Program Line                            |    |  |
| 5  | Highlight Correction                    |    |  |
| 6  | Distortion Correction                   |    |  |
| 7  | Extended Bracketing                     |    |  |
| 8  | HDR Capture                             |    |  |
| 9  | Shadow Correction                       |    |  |
| 10 | Lateral Chromatic Aberration Adjustment |    |  |

## 📎 Memo

- Items that cannot be changed due to the current camera setting status cannot be selected.

## Vertical Display

When the camera is rotated to the vertical position with the exposure lock timer turned on, the status screen and control panel are displayed in a vertical position, and the directions of the ▲▼◀▶ keys also change.

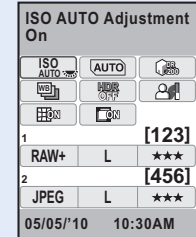

## ● Electronic Level Display

Press the **DISP** button while the status screen is displayed to display the electronic level. A bar graph indicating the horizontal camera angle appears at the bottom of the screen, and a bar graph indicating the vertical camera angle appears on the right side.

### Example:

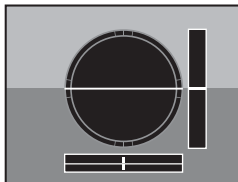

Horizontally and vertically level (green)

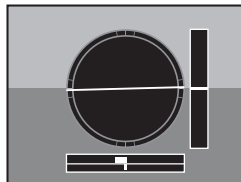

Tilted 1.5° to the left (yellow)  
Vertically level (green)

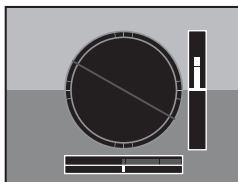

Outside horizontal level display (red)  
Tilted 5° up (yellow)

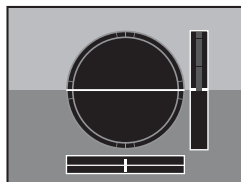

Horizontally level (green)  
Outside vertical level display (red)

## 📌 Memo

- The electronic level display will disappear if no operations are made within 1 minute.
- If the camera angle cannot be detected, both ends and the center of the bar graphs flash red.
- You can select the display setting with [Electronic Level Display] in the [CAM3] menu. (📖 p.R19)

## Playback Mode

The camera changes the type of information display when you press the **INFO** button during image playback.

<b>Standard display</b>	An image and guide indicators are displayed.
<b>Histogram display</b>	An image and its histogram (Brightness/RGB) are displayed.
<b>Detailed information display</b>	Detailed showing of how and when the image was taken is displayed.
<b>No info. display</b>	Only an image is displayed.

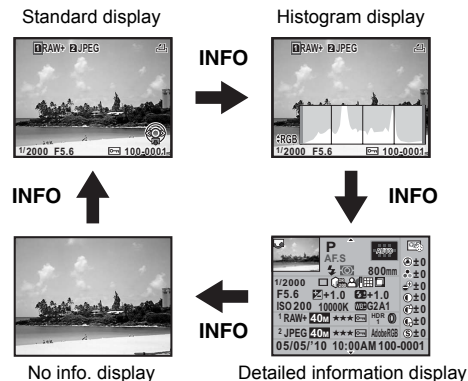

## 📌 Memo

- Press the **DISP** button, **SD1** button, or **SD2** button to switch between the SD Memory Cards to play back.
- The information display that is shown first during playback is the same as that of the last playback in the previous session. The information display type differs depending on the setting of [Memory] in the [CAM4] menu. (📖 p.R20)
- You can set whether to display the Bright/Dark Area warning with [Playback Display Method] in the [CAM1] menu. (📖 p.R22)

## ● Detailed information display

Use the ▲ ▼ keys to switch between pages.

Page 1

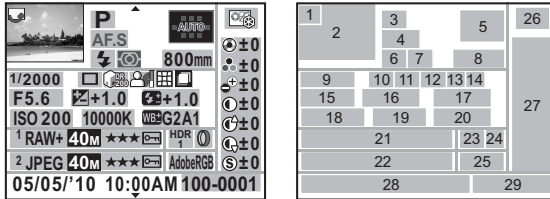

Page 2

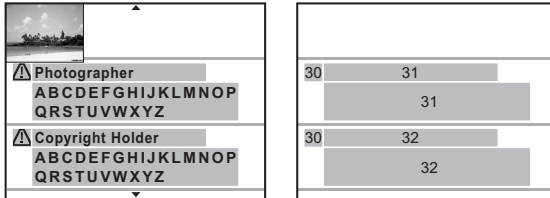

- 1 Rotation Information
- 2 Captured image
- 3 Exposure Mode
- 4 Focus Mode
- 5 AF point
- 6 Flash Mode
- 7 Metering mode
- 8 Focal length
- 9 Shutter speed
- 10 Drive Mode
- 11 Highlight Correction
- 12 Shadow Correction
- 13 Distortion Correction
- 14 Lateral Chromatic Aberration Adjustment
- 15 Aperture value
- 16 EV Compensation
- 17 Flash Exposure Compensation
- 18 Sensitivity
- 19 White Balance
- 20 White Balance fine tuning
- 21 SD1 Image File Format/JPEG Quality/Protect
- 22 SD2 Image File Format/JPEG Recorded Pixels/JPEG Quality/Protect
- 23 HDR Capture/Multi-exposure
- 24 Digital Filter
- 25 Color Space
- 26 Image Tone
- 27 Custom Image parameters
- 28 Shooting date and time
- 29 Folder number-File number
- 30 Information tampering warning
- 31 Photographer
- 32 Copyright Holder

## ● Histogram display

A brightness histogram and RGB histogram can be displayed during image playback. Use the ▲▼ keys to switch between the histogram displays.

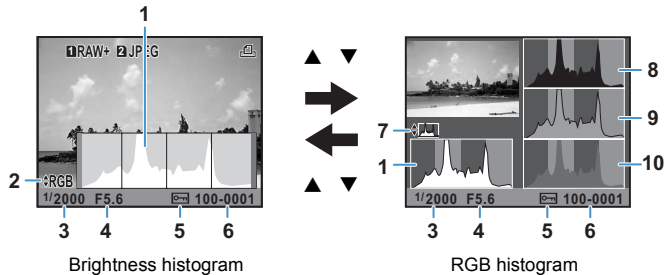

- |   |                           |    |   |
|---|---------------------------|----|---|
| 1 | Brightness histogram      | 7  | Switch Brightness histogram/<br>RGB histogram |
| 2 | Color Space               | 8  | R histogram                                   |
| 3 | Shutter speed             | 9  | G histogram                                   |
| 4 | Aperture value            | 10 | B histogram                                   |
| 5 | Protect setting           |    |   |
| 6 | Folder number-File number |    |   |

# Viewfinder and LCD Panel

## Viewfinder

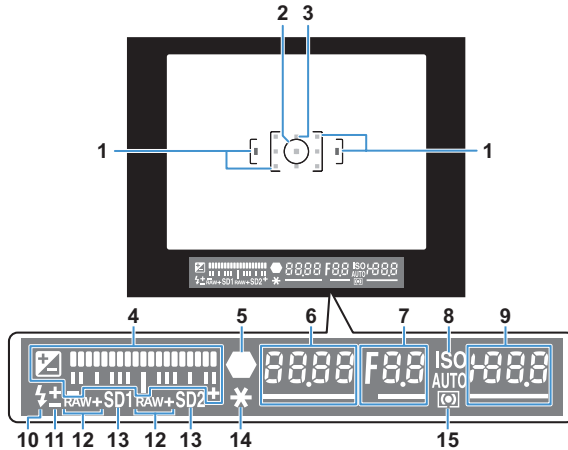

- |  |  |
|--|--|
| 1 AF frame   | 5 Focus indicator                          |
| 2 Spot metering frame (p.45)   | Appears when the subject is in focus.      |
| 3 AF point (p.44)  | Blinks when the subject is not in focus.   |
| 4 EV bar   | 6 Shutter speed                            |
| Shows the EV compensation values or the difference between the appropriate and current exposure values when the exposure mode is set to <b>M</b> or <b>X</b> . | Underlined when the value can be adjusted. |
| Displays the camera angle when [Electronic Level Disp.] is set to $\sphericalangle$ .  | 7 Aperture value                           |
|  | Underlined when the value can be adjusted. |

- |   |  |
|---|--|
| 8 ISO/AUTO  | 11 Flash Exposure Compensation (p.59)        |
| Appears when the sensitivity is displayed.  | 12 File Format (p.42)                        |
| 9 Sensitivity   | Appears when the file format is RAW or RAW+. |
| Underlined when the value can be adjusted.  | Not displayed when the file format is JPEG.  |
| Displays the number of recordable images immediately after shooting. (Max. display is [999].)   | 13 SD1/SD2 slot status (p.42)                |
| When [Electronic Level Disp.] is set to $\sphericalangle$ : Displays the difference between the appropriate and current exposure values when the exposure mode is set to <b>M</b> . | Appears when recording is available.         |
|   | Not displayed when set to OFF or RESERVE.    |
| 10 Flash status   | 14 AE lock (p.49)                            |
| Appears when the flash is available.  | 15 Metering mode (p.45)                      |
| Blinks when the flash is recommended or is being charged.   |  |

### Memo

- The AF points appear in red (superimposed) when the shutter release button is pressed halfway.

### ● EV bar

Shows the difference between the appropriate and current exposure values when the exposure mode is set to **M** or **X**. If the value exceeds the range of the EV bar, the "+" or "-" blinks.



### ● Exposure Warning

When a value that is not the proper exposure is set, that value blinks.



### ● Electronic Level Display

Displays the camera angle when [Electronic Level Disp.] in the [CAM3] menu is set to . (📖 p.R19)

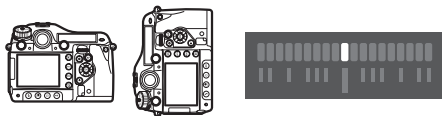

When level (at 0°)



When tilted 5° to the left



When held vertically and tilted 3° to the right

## LCD Panel

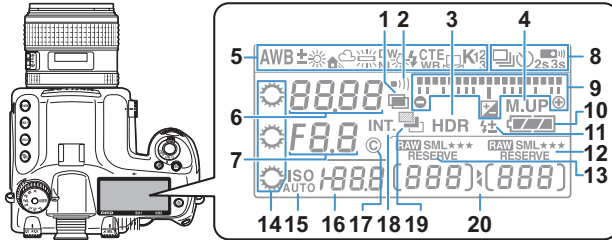

- |   |   |
|---|---|
| 1 Multi-exposure  | 12 SD2 Image File Format/JPEG Recorded Pixels/JPEG Quality (p.42)         |
| 2 Beep<br>Appears when Beep is on.<br>( p.R24)  | <b>RAW</b> : RAW capture<br><b>RAW +</b> : RAW+JPEG capture               |
| 3 HDR Capture ( p.R16)  | 13 SD1 Image File Format/JPEG Recorded Pixels/JPEG Quality (p.42)         |
| 4 Mirror Up   | 14 e-dials<br>Appears when the adjustment is available.                   |
| 5 White Balance (p.50)  | 15 ISO/ISO AUTO<br>Appears when the sensitivity is displayed.             |
| 6 Shutter speed   | 16 Sensitivity/EV compensation value                                      |
| 7 Aperture value  | 17 Copyright Information embedded ( p.R27)                                |
| 8 Drive Mode (p.53)<br>: Single Frame Shooting<br>: Continuous Shooting<br>: Self-timer shooting<br>: Remote Control shooting | 18 Interval Shooting (p.54)   |
| 9 EV bar/Electronic Level Display/EV Compensation (p.48)  | 19 Auto Bracketing<br>Blinks when used together with Extended Bracketing. |
| 10 Battery level (p.29)   |   |
| 11 Flash Exposure Compensation (p.59)   |   |

- 20 Remaining image storage capacity/USB connection mode ( p.R25)/Sensor Cleaning ( p.R29)

**Pc-S**: MSC mode

**Pc-P**: PTP mode

**CIn**: During sensor cleaning

### Memo

- Press the button to illuminate the LCD panel.



# 2

## Getting Started

---

<b>Attaching the Strap .....</b>	<b>24</b>
<b>Attaching the Lens .....</b>	<b>24</b>
<b>Using the Battery .....</b>	<b>28</b>
<b>Inserting/Removing the SD Memory Card .....</b>	<b>31</b>
<b>Power .....</b>	<b>33</b>
<b>Initial Settings .....</b>	<b>34</b>
<b>Diopter Adjustment .....</b>	<b>37</b>
<b>Testing Your Camera .....</b>	<b>37</b>
<b>How to Change Function Settings .....</b>	<b>38</b>

# Attaching the Strap

2

Getting Started

- 1 Pass the end of the strap through the triangular ring.

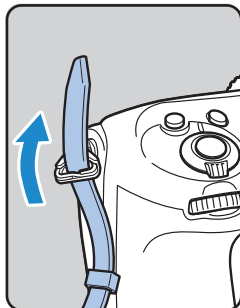

- 2 Secure the end of the strap on the inside of the clasp.

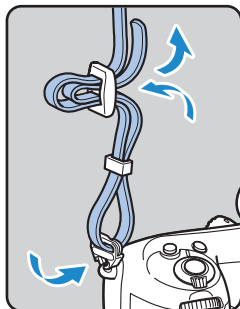

# Attaching the Lens

- 1 Make sure that the camera is turned off.

- 2 Remove the body mount cap (1) and lens mount cap (2).

Hold down the lens unlock button (3) and remove the body mount cap.

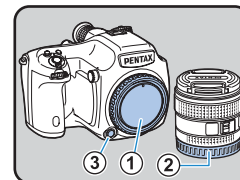

- 3 Align the Lens mount index (red dots; 4) on the camera and the lens, and turn the lens clockwise.

Do not press the lens unlock button at this time.

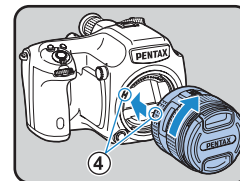

- 4 Remove the front lens cap by pushing the indicated portions.

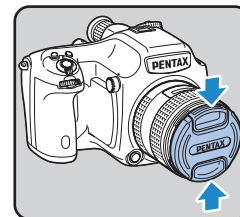

To detach the lens, hold down the lens unlock button and turn the lens counterclockwise.

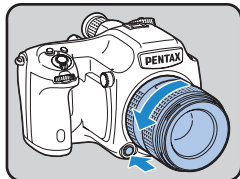

# Lens Compatibility Chart

When using the D FA645 lens (for digital cameras), all of the functions of the **645D** are available. Other PENTAX film camera lenses can also be used with this camera; however, the following restrictions apply.

(✓: Available #: Restricted ×: Not available)

Function	Lens	A645	FA645	A/FA645	A/FA645	67
	Accessories	Lens only		and Rear converter A and Auto extension tube A	and Helicoid extension tube* <sup>1</sup>	and Adapter 645 for 67 lens
P/Sv/Tv/TAv mode		✓	✓	✓	×	×
Av/M mode		✓	✓	✓	✓ <sup>*2</sup>	✓
Program P-TTL auto flash		✓	✓	✓	×	×
P-TTL auto flash		✓	✓	✓	✓	✓
Automatic changing of lighting angle when using AF540FGZ/AF500FTZ/AF360FGZ/AF330FTZ		×	✓	×	×	×
Display of aperture value in viewfinder at aperture position <b>A</b>						
Display of aperture guide in viewfinder at a position other than <b>A</b> <sup>*8</sup>		✓	✓	# <sup>*3</sup>	×	×
AF		×	✓	×	×	×
Display of focus indicator in viewfinder in manual focus mode <sup>*4</sup>		✓ <sup>*5</sup>	✓ <sup>*6</sup>	✓	✓ <sup>*5</sup>	✓ <sup>*5</sup>
Metering mode switching		✓	✓	✓	# <sup>*7</sup>	# <sup>*7</sup>
Lens Correction function		×	✓	×	×	×

\*1 This includes all types of helicoid extension tubes and accessories without information contacts.

\*2 Stop down metering

\*3 The lens aperture value is displayed when using Auto extension tube A or Rear converter A645 2X.

The display will differ when using Rear converter A645 1.4× with a lens other than A\*645 300mm F4 or FA\*645 300mm F4.

**[Displaying the lens aperture value as is indicated on the lens]**

FA645 300mm F5.6, FA645 400mm F5.6, A\*645 600mm F5.6



**[Displaying the maximum effective aperture value when combined with a lens]**

A645 200mm F4, FA645 200mm F4, A\*645 300mm F4, FA\*645 300mm F4, A645 macro 120mm F4, FA645 macro 120mm F4

**[Displaying the aperture value with the aperture stopped down by two stops]**

FA645 150mm F2.8

\*4 Available only when the lens aperture value without accessories is F5.6 or wider, or when the maximum effective aperture value combined with accessories is F5.6 or wider.

\*5 When using A645 macro 120mm F4, its function may become unreliable when the magnification ratio on the lens is set to between "1" (1:1) and "2" (1:2). The focus indicator appears in the viewfinder with the focus area switched to  (Center), even if  (Auto) or **SEL** (Select) is selected as the focus area.

\*6 The focus indicator appears in the viewfinder with the camera focused on the subject by using three AF points, even if you selected  or **SEL** as the focus area.

\*7 The camera operates with center-weighted metering even when multi-segment metering is selected.

\*8 Depending on the lens, the aperture ring value and the value displayed in the viewfinder may not match.

## ⚠ Caution

- We assume no responsibility nor liability for accidents, damages and malfunctions resulting from the use of lenses made by other manufacturers.

## Using the Lens Shutter of the LS Lens

The PENTAX 645LS lens is equipped with a shutter that enables high-speed sync shooting.

To use the lens shutter, switch the shutter speed ring on the lens to LS. Note the following restrictions when using this function.

- The exposure mode switches to **M** regardless of the exposure mode setting on the camera.
  - The difference from the appropriate exposure is not displayed.
  - [LS] is displayed for the shutter speed of the camera.
  - The appropriate exposure is not selected even when the  button is pressed.
- EV Compensation is not available.
  - Setting the shutter speed ring to LS when EV Compensation is set cancels EV Compensation.
- AE lock is not available.
  - Setting the shutter speed ring to LS when AE lock is set cancels AE lock.
- Continuous Shooting of the drive mode, Self-timer (2s delay), Remote Control (3s delay), and Remote Continuous Shooting are not available.
  - Setting the shutter speed ring to LS when Continuous Shooting or Self-timer (2s delay) is set switches the shooting mode to Single Frame Shooting.
  - Setting the shutter speed ring to LS when Remote Control (3s delay) or Remote Continuous Shooting is set switches the shooting mode to Remote Control.

- Mirror lock-up shooting is not available.
  - Setting the shutter speed ring to LS when the mirror is raised lowers the mirror.
  - The shutter cannot be released when the shutter speed ring is set to LS and the **MUP** dial is set to the “UP” position.
- Optical Preview is not available.
  - If the lens shutter is charged in advance, Digital Preview can be used. (The same applies when using the Digital Preview to preview the image with White Balance or Custom Image.)
- Interval Shooting, Exposure Bracketing, and HDR Capture are not available.
  - Setting the shutter speed ring to LS when Exposure Bracketing or HDR Capture is set cancels the setting.
  - Setting the shutter speed ring to LS when Interval Shooting is set exits Interval Shooting.
- In Multi-exposure mode, the lens shutter must be charged manually for each shot.
- An external flash cannot be used even when connected to the hot shoe. Be sure to use the sync terminal on the lens.
- An external flash cannot be synchronized even when connected to the X-sync socket on the camera.
- The flash mode setting is not applied to LS shooting.

# Using the Battery

Use only a rechargeable lithium-ion D-LI90 battery.

Note: AC plug cord “Listed, Type SPT-2 or NISPT-2, 18/2 flexible cord, rated 125V, 7A, minimum 6ft (1.8m)”

## Charging the Battery

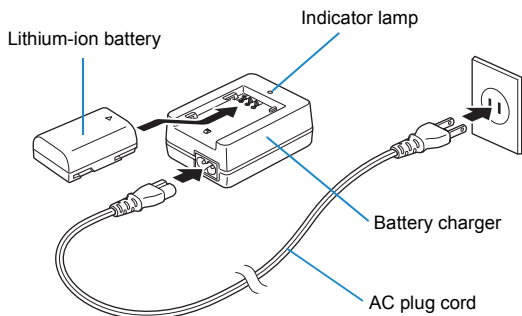

- 1** Connect the AC plug cord to the charger.
- 2** Plug the AC plug cord into the power outlet.
- 3** Face the ▲ mark on the battery up and insert it into the battery charger.

The indicator lamp turns on during charging and turns off when the battery is fully charged.

- 4** Remove the battery from the battery charger.

### ⚠ Caution

- Do not use the provided battery charger to charge batteries other than battery D-LI90. Charging other batteries may cause damage or overheating.
- If the battery is correctly oriented and inserted into the battery charger but the indicator lamp is not lit, the battery is faulty. Use a new battery in the camera.

### 📎 Memo

- The maximum charging time is approximately 390 minutes. Charge in a location where the temperature is between 0°C and 40°C.
- If usage time is reduced, the battery has reached the end of its usage span. Use a new battery in the camera.

## Inserting/Removing the Battery

### ⚠ Caution

- Do not open the battery cover or remove the battery while the power is on.
- Remove the battery when you will not use the camera for a long while. Otherwise, the battery may leak.
- If the battery is removed for a long while, the date and time settings may be reset.

### 1 Open the battery cover.

Lift the battery cover unlock knob, turn towards OPEN (①) to unlock, and then pull the cover open (②).

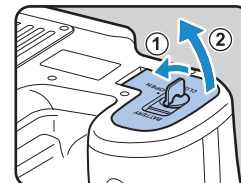

- 2** Face the ▲ mark on the battery towards the outside of the camera, push the battery lock lever in the direction of the arrow (③) and insert the battery.

To remove the battery, push the battery lock lever in the direction of the arrow (③) with your finger.

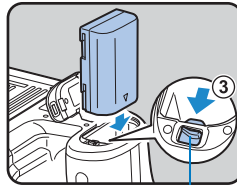

Battery lock lever

- 3** Close the battery cover (④) and turn the battery cover unlock knob towards CLOSE (⑤) to lock.

Stow the battery cover unlock knob.

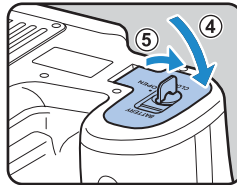







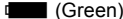

### Memo

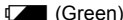
- Use the AC adapter kit K-AC50 (optional) when using the camera for a prolonged period. (p.30)

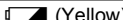
## Battery Level Indicator

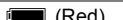
You can confirm the remaining battery level by checking the battery level indicator on the status screen or LCD panel.

Status Screen	LCD Panel	Battery Level
 (Green)		Battery is full.
 (Green)		Battery is one-third empty.
 (Yellow)		Battery is two-thirds empty.
 (Red)	 lit	Battery is almost empty.
[Battery depleted]	 blinks	The camera turns off after displaying the message. (The LCD panel indicator continues to blink.)

### Memo

- The displayed battery level may not be correct when the camera is used at low temperatures or when performing continuous shooting for long periods of time.
- Battery performance decreases at low temperatures. When using the camera in cold climates, keep the battery warm in your pocket. Battery performance will return to normal when returned to room temperature.
- The battery level is not displayed when using the AC adapter.

## Using the AC Adapter (Optional)

We recommend using the AC adapter kit K-AC50 (optional) when using the monitor for a long time or when connecting to your PC or AV equipment.

- 1 Make sure that the camera is turned off.**
- 2 Open the terminal cover.**
- 3 Face the ▲ mark on the DC terminal of the AC adapter towards the ▲ mark on the camera, and connect the DC terminal to the DC input terminal of the camera.**

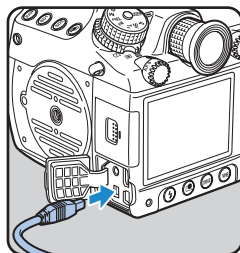

- 4 Connect the AC plug cord to the AC adapter, and then plug the AC plug cord into the power outlet.**

### Memo

- Make sure the camera is turned off before connecting or disconnecting the AC adapter.
- Make sure that all the terminals are securely connected. The SD Memory Card and data may become corrupted if the connection is dropped while the camera is accessing the SD Memory Card.
- The battery in your camera will not charge when connected to the AC adapter.
- Be sure to read the AC adapter kit K-AC50 Operating Manual when using the AC adapter.



# Inserting/Removing the SD Memory Card

This camera can use up to two commercially available SD Memory Cards or SDHC Memory Cards (collectively referred to as “SD Memory Cards” in this manual). Ideally you should use a high-speed, large-capacity SD Memory Card.

## ⚠ Caution

- An SD Memory Card must be formatted with this camera before use. (☞ “Formatting an SD Memory Card” p.36)

## 1 Make sure that the camera is turned off.

## 2 Slide the card cover in the direction of the arrow (①) and then lift it to open (②).

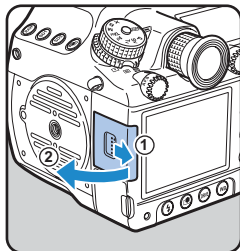

## 3 Insert the card all the way into the SD1 or SD2 slot with the SD Memory Card label facing toward the monitor.

Insert an SD Memory Card into one or both of the SD1 and SD2 slots.

To remove the SD Memory Card, push the card in again.

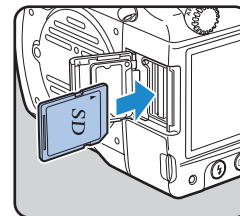

## 4 Close the card cover and then slide it in the opposite direction of the arrow (①).

## ⚠ Caution

- Be sure to fully close the card cover. The camera will not turn on if the card cover is open.
- Do not turn off the power or remove the SD Memory Card while the card access lamp is lit.

## 📌 Memo

- Refer to “Setting the File Format and Data Saving Method” (p.42) for details on how to save data to the SD Memory Cards in the SD1 and SD2 slots.

## Precautions When Using the SD Memory Card

- The SD Memory Card is equipped with a write-protect switch. Setting the switch to LOCK prevents new data from being recorded on the card, the stored data from being deleted, and the card from being formatted by the camera or computer.
- The SD Memory Card may be hot when removing the card immediately after using the camera.
- Do not remove the SD Memory Card or turn off the power while the card access lamp is lit. This may cause the data to be lost or the card to be damaged.
- Do not bend the SD Memory Card or subject it to violent impact. Keep it away from water and store away from high temperatures.
- Do not remove the SD Memory Card while formatting. The card may be damaged and become unusable.
- Data on the SD Memory Card may be deleted in the following circumstances. We do not accept any liability for data that are deleted if
  - (1) the SD Memory Card is mishandled by the user.
  - (2) the SD Memory Card is exposed to static electricity or electrical interference.
  - (3) the SD Memory Card has not been used for a long time.
  - (4) the SD Memory Card or the battery is removed while the card is being accessed.
- If it is not used for a long time, the data on the card may become unreadable. Be sure to regularly make a backup of important data on a computer.
- Avoid using or storing the card where it may be exposed to static electricity or electrical interference.
- Avoid using or storing the card in direct sunlight or where it may be exposed to rapid changes in temperature or to condensation.

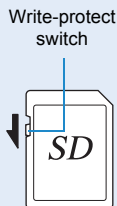

- Format new SD Memory Cards. Also format SD Memory Cards used with other cameras. (See "Formatting an SD Memory Card" p.36)
- The data on your SD Memory Card should be managed at your own risk.

# Power



## 1 Turn the main switch to [ON].

The camera will turn on.

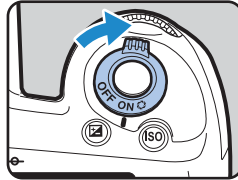
Set the main switch to the position [OFF] to turn off the camera.



## Memo

- Always turn the camera off when not in use.
- The power will automatically turn off when you do not perform any operations within a set period of time (Auto Power Off). To reactivate the camera after it turns off automatically, turn it on again or perform any of the following.
  - Press the shutter release button halfway.
  - Press the  button, **MENU** button or **INFO** button.
- By default, the camera is set to power off automatically after 1 minute of inactivity. You can change the setting in [Auto Power Off] in the [3] menu. ( p.R27)

# Initial Settings

## Language Setting

The first time the camera is turned on after purchase, the [Language/言語] screen appears on the monitor. Follow the procedure below to set the display language and the current date and time.

### 1 Use the ▲▼◀▶ keys to select a desired language and press the OK button.

The [Initial Setting] screen in the selected language appears.



### 2 Press the ▼ key.

The cursor moves to ↗ (Hometown). If the hometown is set as you desire, proceed to Step 7 on p.34.

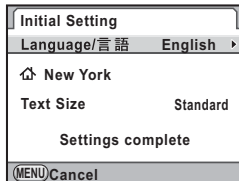

### 3 Press the ▶ key.

The [↗ Hometown] screen appears.

### 4 Use the ◀▶ keys to choose the hometown.

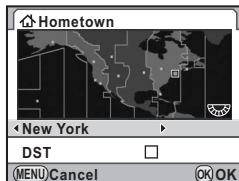

### 5 Press the ▼ key.

The cursor moves to [DST] (daylight saving time).

### 6 Use the ◀▶ keys to select or , and press the OK button.

The camera returns to the [Initial Setting] screen.

### 7 Press the ▼ key.

The cursor moves to [Text Size].

### 8 Press the ▶ key, use the ▲▼ keys to select [Standard] or [Large], and press the OK button.

Selecting [Large] increases the text size of the selected menu item.

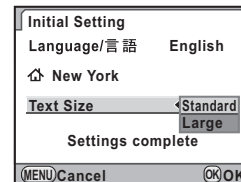

### 9 Press the ▼ key to select [Settings complete] and press the OK button.

The [Date Adjustment] screen appears.

## Memo

- You can select from 75 cities for the hometown and destination. (📖 p.R23)
- In this manual, the menu screens hereafter are described with [Text Size] set to [Standard].
- To change the Language, Hometown or Text Size settings, use the [↵1] menu. (📖 p.R23)

## Date Adjustment

- 1 On the [Date Adjustment] screen, press the ► key and use the ▲ ▼ keys to choose the date format.

Choose [mm/dd/yy], [dd/mm/yy] or [yy/mm/dd].

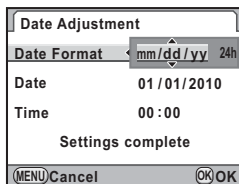

- 2 Press the ► key and use the ▲ ▼ keys to select [24h] (24-hour display) or [12h] (12-hour display).

- 3 Press the ► key.

The frame returns to [Date Format].

- 4 Press the ▼ key and then the ► key.

The frame moves to the month.

- 5 Use the ▲ ▼ keys to set the month, day and year.

- 6 Set the time in the same manner.

If you select [12h] in Step 2, the camera switches between am and pm depending on the time.

- 7 Select [Settings complete] and press the OK button.

The status screen is displayed and the camera switches to Capture mode.

The seconds value is set to 0 seconds when the OK button is pressed.

## Memo

- Pressing the **MENU** button while setting the date and time cancels the settings and switches the camera to Capture mode. The [Initial Setting] screen or the [Date Adjustment] screen will appear again the next time the power is turned on.
- To change the date and time, use the [1] menu. (p.R23)

## Formatting an SD Memory Card

An SD Memory Card must be formatted with this camera before use.

### Caution

- Do not remove the SD Memory Card while formatting. The card may be damaged and become unusable.
- Formatting an SD Memory Card deletes all images on the card even protected images.

### 1 Press the MENU button.

The [M1] menu appears.

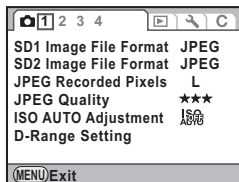

### 2 Turn the dial to select the [4] menu.

### 3 Use the ▲ ▼ keys to select [Format] and press the ► key.

The [Format] screen appears.

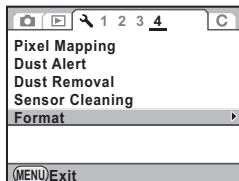

### 4 Use the ▲ ▼ keys to select the card to format and press the OK button.

You cannot select a card when either one of the cards is locked or not inserted.

### 5 Press the ▲ key to select [Format] and press the OK button.

Formatting starts.

When formatting is completed, the camera returns to Capture mode.

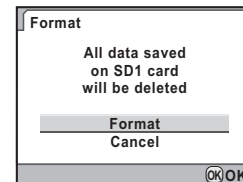

# Dioptr Adjustment

You can adjust the diopter from approximately  $-3.5$  to  $+2.0 \text{ m}^{-1}$ .

- 1 Turn the diopter adjustment ring while looking through the viewfinder.

Turn the diopter adjustment ring clockwise for a negative value and counterclockwise for a positive value.

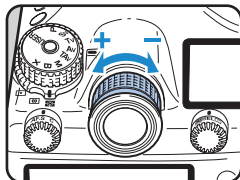

## Attaching the Large Eyecup

Attach the Large Eyecup 645 O-EC107 as needed.

- 1 Slightly stretch the rim of the large eyecup and attach it on the camera, covering over the standard eyecup.

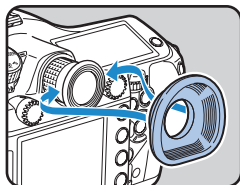

# Testing Your Camera

## Shooting

Take some test pictures to familiarize yourself with the camera.

- 1 View the subject through the viewfinder and press the shutter release button.

The picture is taken.

The image appears for 1 second (default setting) on the monitor shortly after capturing (Instant Review).

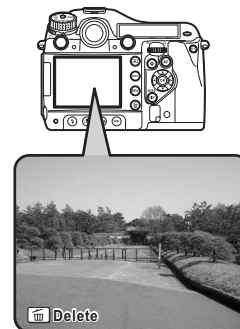

### Available operations during Instant Review

dial	Enlarges Instant Review (p.67)
button	Deletes an image (p.67)

### Memo

- You can set the Instant Review display with the [CAM3] menu. ( p.R18)

## Playing Back Captured Images

You can play back captured images.

### 1 Press the button.

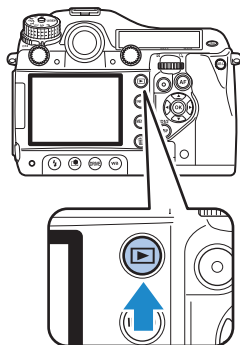

The camera enters Playback mode and the most recently captured image (image with the highest file number) is displayed on the monitor.

Press the **INFO** button to switch the information display for the image. (p.17)



### 2 View the images.

#### Available operations

◀ key or  dial to the left	Shows the previous image.
▶ key or  dial to the right	Shows the next image.
<b>DISP</b> button/ <b>SD1</b> button/ <b>SD2</b> button	Switches between the SD Memory Cards.

#### Memo

- Refer to “Playback and Processing Functions” (p.65) for details on playback functions.
- Use the provided “PENTAX Digital Camera Utility 4” software to play back pictures using a computer. ( “Using a Computer” p.81)

## How to Change Function Settings

Function settings can be changed using the direct keys, control panel or menus. Some functions can be changed using both the control panel and menus.

This section explains the basic ways to change function settings.

### Using the Direct Keys

You can use the direct keys in Capture mode to directly set functions.

The following explains how to set the flash mode as an example.

### 1 Press the button in Capture mode.

The [Flash Mode] screen appears.

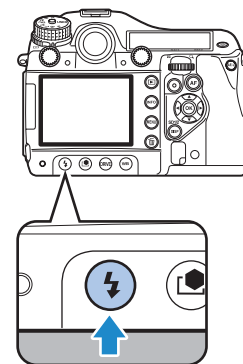



- 2** Use the ◀▶ keys to select a flash mode.

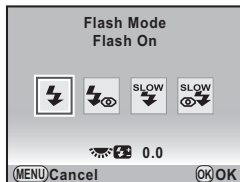

- 3** Press the OK button.

The camera switches to Capture mode.

## Using the Control Panel

The following explains how to set the Program Line as an example.

- 1** Press the INFO button in Capture mode.

The control panel appears.

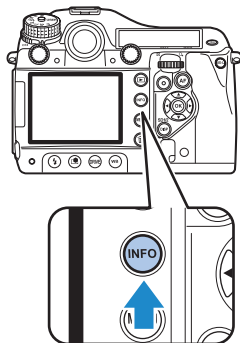

- 2** Use the ▲▼◀▶ keys to select the item you want to change the setting for.

You cannot select an item that cannot be changed with current camera settings.

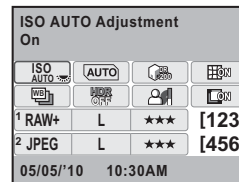

- 3** Use the ☀/☂ dials to change the setting.

Press the OK button to display the detailed setting screen for the selected item. For some items such as Extended Bracketing, you can make more detailed settings from the detailed setting screen.

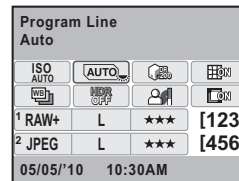

- 4** Press the INFO button.

The camera switches to Capture mode.

## Using the Menu

This section explains how to use the menus: [CAMERA] Rec. Mode], [REPLAY] Playback], [SETUP] Set-up] and [CUSTOM] Custom Setting].

The following explains how to set [Program Line] in the [CAMERA2] menu as an example.

### 1 Press the MENU button in Capture mode.

The [CAMERA1] menu appears on the monitor.

Press the **MENU** button in Playback mode to display the [REPLAY1] menu first.

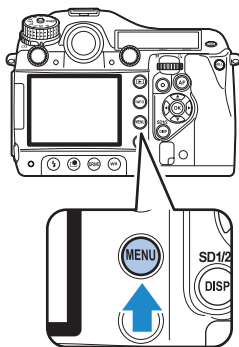

### 2 Press the ► key or turn the dial to the right (Q).

Each time the ► key is pressed, the menu will change in the following sequence: [CAMERA2], [CAMERA3], [CAMERA4], [REPLAY1] ...[CAMERA1].

When the  dial is turned to the right, the category will change in the following sequence: [CAMERA1], [REPLAY1], [SETUP1], [CUSTOM1].

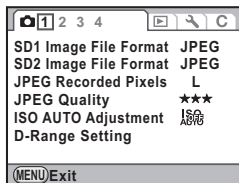

### 3 Use the ▲▼ keys to select an item and press the ► key.

Available settings are displayed. The frame moves to the pop-up menu if there is one.

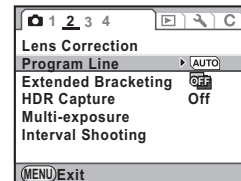

### 4 Use the ▲▼ keys to select an item and press the OK button.



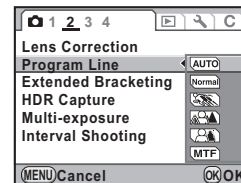





The camera returns to the menu screen. Next, set other items. Press the **MENU** button to exit the menu and return to the screen that was displayed before the menu was selected.



### Caution

- Your settings may not be saved if the camera is turned off improperly (such as by removing the battery while the camera is on).

### Memo

- Refer to “Menu Reference” for details on each menu.
  -  Rec. Mode Menu  p.R13
  -  Playback Menu  p.R22
  -  Set-up Menu  p.R23
  -  Custom Setting Menu  p.R30

# 3

## Shooting Functions

<b>Setting the File Format and Data Saving Method .....</b>	<b>42</b>
<b>Focusing .....</b>	<b>44</b>
<b>Exposure Setting .....</b>	<b>45</b>
<b>White Balance .....</b>	<b>50</b>
<b>Drive Mode .....</b>	<b>53</b>
<b>Auto Bracketing .....</b>	<b>56</b>
<b>Flash Mode .....</b>	<b>58</b>
<b>Preview .....</b>	<b>61</b>
<b>Custom Image .....</b>	<b>62</b>

# Setting the File Format and Data Saving Method

Before shooting, you can set the file format, recorded pixels and quality level of captured images and how they are saved to the SD Memory Card.

## File Format

You can set the data saving method and file format for images saved to the SD Memory Cards in the SD1 and SD2 slots. Regardless of the number of inserted cards, you can configure the setting for each card slot individually. For example, JPEG images can be saved to one card slot while RAW images are saved to the other slot, or you can have images captured in the same format to both card slots at the same time as a data backup.

<b>JPEG</b>	Captures images in JPEG format. (default setting) If [JPEG] is selected, next set the [JPEG Recorded Pixels] and [JPEG Quality] settings.
<b>RAW</b>	Captures images in RAW format. After shooting, use RAW Development (p.72) or the provided "PENTAX Digital Camera Utility 4" software for RAW image development (p.84).
<b>RAW+</b>	Captures images in both RAW and JPEG formats and saves them to one card.
<b>RESERVE</b>	When either of SD Memory Cards becomes full, images are saved to the other one in the same file format. If an SD Memory Card which is not set to [RESERVE] becomes full or is removed, images are saved to the other one which is set to [RESERVE].
<b>OFF</b>	The card slot is not used. When using only one SD Memory Card, use this setting for the unused slot.

## Setting examples

SD1 Slot	SD2 Slot	Operation
JPEG	JPEG	Saves images in the same file format (JPEG) to the cards in the SD1 and SD2 slots. (Data backup)
JPEG	RAW	Saves JPEG images to the card in the SD1 slot and RAW images to the card in the SD2 slot.
JPEG	RAW+	Saves JPEG images to the card in the SD1 slot and RAW and JPEG images to the card in the SD2 slot. JPEG images saved to the cards in the SD1 and SD2 slots have the same [JPEG Recorded Pixels] and [JPEG Quality] settings.
JPEG	RESERVE	When the card in the SD1 slot is full, images are saved in the same format to the card in the SD2 slot. If the SD1 slot has a new card, when the card in the SD2 slot is full, images are saved to the card in the SD1 slot.
JPEG	OFF	The SD2 slot is unused.

## Memo

- Only one slot can be set to [RESERVE] or [OFF].
- Set the RAW file format in the [4] menu. (p.R19)
- You can temporarily change the file format by simply pressing the **RAW** button. Set this with [RAW Button] in the [4] menu. (p.R19)

## 1 Turn the dial while pressing the SD1 button.

The setting changes in the following sequence: JPEG, RAW, RAW+, RESERVE, OFF.

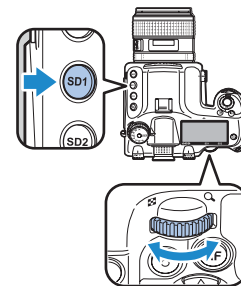

## 2 Turn the dial while pressing the SD2 button.

Configure the setting for the SD Memory Card in the SD2 slot in the same manner.

### Caution

- Depending on the setting and condition for storing the data, when one or both of the SD Memory Cards become full and no more images can be saved, an error message appears and the shutter locks.
- When [JPEG] or [RAW+] is set for both cards, the JPEG images saved to both cards have the same [JPEG Recorded Pixels] and [JPEG Quality] settings.

### Memo

- You can check the data saving status for each slot on the status screen (p.15), LCD panel (p.22) and in the viewfinder (p.20).

## JPEG Recorded Pixels/Quality Level

When [JPEG] is selected as the file format, set the recorded pixels and quality level (★★★ Best, ★★ Better, and ★ Good). This does not have to be set when [RAW] is selected as the file format.

Setting	Recorded Pixels	Pixels
L	40M	7264×5440
M	32M	6528×4896
	21M	5376×4032
S	13M	4224×3168
	7M	3072×2304

Set the recorded pixels for **M** and **S** with [35. M and S Pixel Resolution] in the [C5] menu. ( p.R35)

## 1 Turn the dial while pressing the SD1/SD2 button.

The setting changes in the following sequence: L★★★ (default setting), L★★, L★, M★★★, M★★, M★, S★★★, S★★, S★.

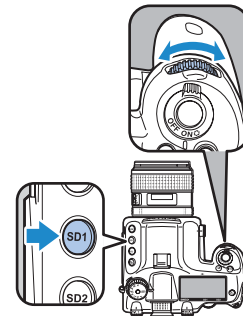

### Memo

- If you set [JPEG] or [RAW+] for both cards, when either the **SD1** or **SD2** button is used to set the recorded pixels and quality level, both cards will have the same settings.

# Focusing

3

Shooting Functions

## Selecting the Focus Mode

- 1 Select [AF] or [MF] on the lens.

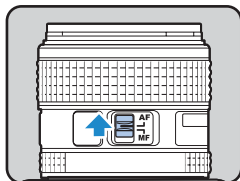

- 2 Use the AF mode switching dial on the camera to select the AF mode.

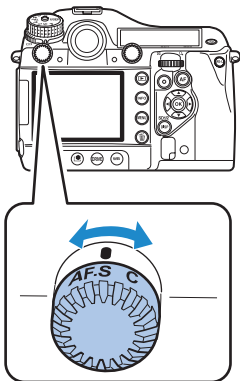

<b>AF.S</b> Autofocus/Single mode	Locks the focus at the position where the subject is in focus.
<b>C (AFC)</b> Autofocus/Continuous mode	Continuously adjusts the focus to keep the subject in focus. The shutter can be released even if autofocus does not work. The camera automatically tracks the subject if the subject is determined to be a moving object during focusing.

## Memo

- You can use the **AF** button to focus on the subject in the same manner as when pressing the shutter release button halfway. You can also use [13. AF Button Function] in the [C2] menu to set the **AF** button function to [AF Cancel]. (📖 p.R31)
- You can adjust the AF focus position with [33. AF Fine Adjustment] in the [C5] menu. (📖 p.R35)

## AF Point Switching

AUTO	Auto	The camera selects an optimum AF point in the viewfinder.
SEL	Select	You can select the desired focus position from the set number of AF points in the AF area.
-	Center	Sets the focus position to the center of the viewfinder.

- 1 Turn the AF point switching dial.



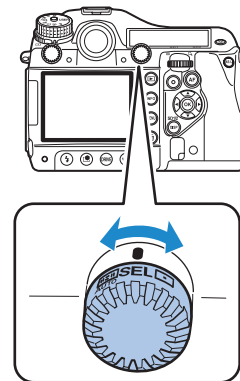

The selected AF point lights red in the viewfinder (Superimpose AF Area).



## 2 When [SEL] is selected, use the ▲ ▼ ◀ ▶ keys to select the desired focus position.

Pressing the **OK** button returns the focus position to the center.

### Memo

- To turn off the red light of the superimposed AF point, set [15. Superimpose AF Area] to [Off] in the [C3] menu. (📖 p.R32)
- You can select the number of AF points from 11 (default setting), 5 or 3. The selected AF points are used as the focus position when the AF point switching dial is set to **SEL**. Set this with [16. Number of AF Points] in the [C3] menu. (📖 p.R32)
- The focus position selected when set to **SEL** is saved even if the camera is turned off or the focus area is switched to  or .
- When any of the following operations are performed, changing of the AF point (in Step 2) is canceled.
  - The main switch is turned off
  - The AF point switching dial is turned
  - The mode dial is turned
  - The  or **MENU** button is pressed
- When the camera is used with the A645 mount lens, an intermediate ring, or other accessory, the focus area is always set to .

# Exposure Setting

## Selecting the Metering Mode

### 1 Turn the metering mode switch.

The set metering mode is displayed in the viewfinder and on the status screen.

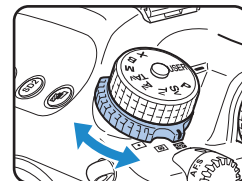

#### Multi-segment metering

The image in the viewfinder is metered in 77 different zones.

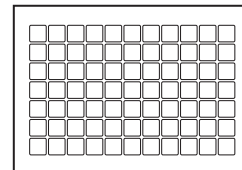

#### Center-weighted metering

Metering is weighted at the center of the viewfinder image. The sensitivity at the center of the image is high and is not automatically compensated even for backlit scenes.

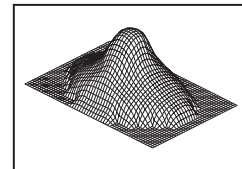

#### Spot metering

Metering is performed only for a limited area at the center of the viewfinder image.

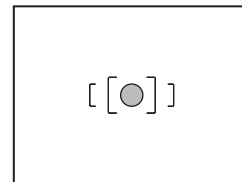

## 3

### Shooting Functions

### Memo

- You can set whether to link the exposure and AF point in the focus area during multi-segment metering. Set this with [6. Link AE to AF Point] in the [C1] menu. ([p.R30](#))

### Exposure Lock Timer

Set the exposure lock time with [4. Meter Operating Time] in the [C1] menu. ([p.R30](#))

## Setting the Sensitivity

You can set the sensitivity to [AUTO] (default setting) or a value in the range equivalent to ISO 200 to 1000.

### 1 Turn the dial while pressing the ISO button.

Press the  button while pressing the ISO button to return to [AUTO].

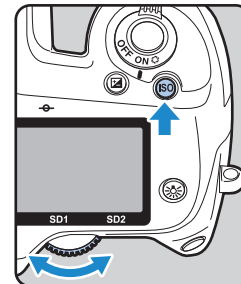

### Memo

- Set the range of automatic sensitivity adjustment with [ISO AUTO Adjustment] in the [1] menu or on the control panel. ([p.R14](#))
- You can set the sensitivity in increments of 1 EV or in accordance with the EV step setting for exposure. It can be set with [2. Sensitivity Steps] in the [C1] menu. ([p.R30](#))
- You can expand the sensitivity range to ISO 100 to 1600 with [3. Expanded Sensitivity] in the [C1] menu. ([p.R30](#))
- You can reduce noise at high sensitivity with [20. High-ISO Noise Reduction] in the [C3] menu. ([p.R32](#))



## Changing the Exposure Mode

The following are the available exposure modes.

(✓: Available ×: Not available)

Exposure Mode	Function	EV Compensation	Change Shutter Speed	Change Aperture Value	Change Sensitivity
<b>P</b> Hyper-program	Automatically sets the shutter speed and aperture value according to Program Line. You can use the front and rear e-dials to switch between shutter priority and aperture priority.	✓	✓	✓	✓
<b>Sv</b> Sensitivity Priority	You can set the desired sensitivity.	✓	×	×	Other than AUTO
<b>Tv</b> Shutter Priority	You can set the desired shutter speed.	✓	✓	×	✓
<b>Av</b> Aperture Priority	You can set the desired aperture value.	✓	×	✓	✓
<b>TAv</b> Shutter & Aperture Priority	Automatically sets the sensitivity according to the set shutter speed and aperture value.	✓	✓	✓	AUTO only
<b>M</b> Hyper-manual	You can set all settings.	✓	✓	✓	Other than AUTO
<b>B</b> Bulb	Bulb shooting	×	×	✓	Other than AUTO
<b>X</b> Flash X-sync Speed	The shutter speed is locked at 1/125 seconds. Use this when using a flash that does not automatically set the sync speed.	✓	×	✓	Other than AUTO
<b>USER</b> User setting	Lets you capture images with the previously-saved exposure mode and settings.	–	–	–	–

### Memo

- Set Program Line on the control panel or in the [CAM2] menu. (📖 p.R15)
- Set USER in the [CAM4] menu. (📖 p.R20)

- 1 Turn the mode dial while pressing the mode dial lock button.

Mode dial lock button

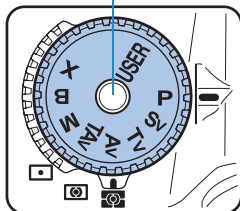

- 2 Use the / dials to change the setting.

/ appears on the monitor next to the setting that is being changed.

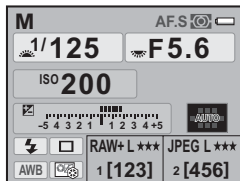

### Memo

- Set the functions of the e-dials for each mode in the [C4] menu. (p.R33 - p.R34)

## EV Compensation

You can adjust the EV compensation from -5 to +5 (EV).

- 1 Turn the dial while pressing the button.

is displayed during compensation. Press the button while pressing the button to return to "0.0".

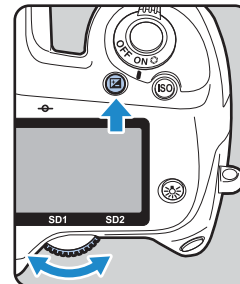

### Memo

- Set the EV steps with [1. EV Steps] in the [C1] menu. (p.R30)

### EV Compensation for M and X modes

If you set the EV compensation to a positive (+) value for **M** and **X** modes, underexposure is displayed on the EV bar. If you set the exposure so that the is displayed at the center of the EV bar, the image will be captured with the compensated value.

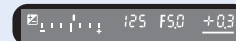

## AE Lock

AE lock is a function that locks the exposure prior to taking the picture.

### 1 Press the AE-L button.

The camera locks the exposure. \* is displayed on the status screen and in the viewfinder while the AE lock is engaged.

Press it again to cancel the AE lock.

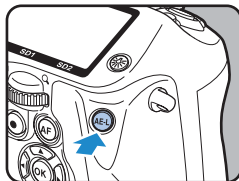







### Memo

- The exposure remains in memory for between half and twice the amount of the exposure lock time, even after you take your finger off the **AE-L** button.
- You will hear a beep when the **AE-L** button is pressed. You can change the setting with [Beep] in the [**1**] menu. (p.R24)
- When the AE lock is set in **M** mode, you can change the shutter speed and aperture value while maintaining the exposure value.
- AE lock is not available in **B** or **X** mode.
- When any of the following operations are performed, AE lock is canceled.
  - The **AE-L** button is pressed again
  - The **INFO** button, **MENU** button or **INFO** button is pressed
  - The mode dial is turned
  - The metering mode switch is turned
  - The lens is changed
  - The lens with an aperture **A** position is set to the **A** position or is switched to another position

- When using a zoom lens whose maximum aperture value varies depending on the focal length, the shutter speed and aperture value change depending on the zooming position while the AE lock is engaged. However, the exposure value does not change and a picture is taken at the brightness level set by the AE lock.
- Exposure can be locked when the focus is locked. Set this with [5. AE-L with AF Locked] in the [**C1**] menu. (p.R30)

# White Balance

The following settings are available.

	Setting	Color Temperature
<b>AWB</b>	Auto (default setting)	Approx. 4,000 to 8,000K
	Daylight	Approx. 5,200K
	Shade	Approx. 8,000K
	Cloudy	Approx. 6,000K
	Fluorescent Light	
	<b>D</b> Fluorescent Light Daylight Color	Approx. 6,500K
	<b>N</b> Fluorescent Light Daylight White	Approx. 5,000K
	<b>W</b> Fluorescent Light Cool White	Approx. 4,200K
<b>L</b> Fluorescent Light Warm White	Approx. 3,000K	
	Tungsten Light	Approx. 2,850K
	Flash	Approx. 5,400K
<b>CTE</b>	Color Temperature Enhancement	–
	Manual 1-3	Approx. 2,500 to 10,000K
<b>K</b>	Color Temperature 1-3	–

## 1 Press the **WB** button.

The [White Balance] screen appears.

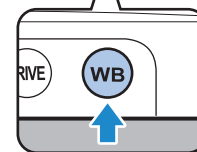
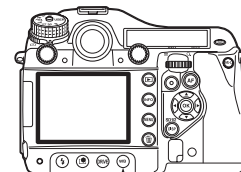

## 2 Use the **▲ ▼** keys to select the white balance.

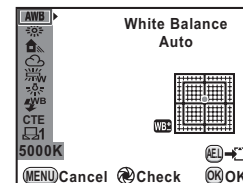

### Available operations

- |                    |   |
|--------------------|---|
| Main switch (🔄)    | Displays the background image with Digital Preview. |
| <b>AE-L</b> button | Saves the background image as a new file.           |

### 3 To fine-tune the white balance, press the ► key.

Seven levels (225 patterns) are available on the G-M and B-A axes.

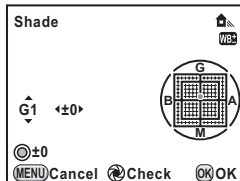

#### Available operations

▲▼ keys	Adjusts the tone of the colors between green (G) and magenta (M).
◀▶ keys	Adjusts the tone of the colors between blue (B) and amber (A).
⊙ button	Resets the adjustment value.

### 4 Press the OK button.

The camera switches to Capture mode.



#### Memo

- The white balance of a JPEG image can also be adjusted after shooting. Immediately after shooting, press the **WB** button and change the setting, and then press the **AE-L** button and select [Save as].
- The camera automatically performs fine-tuning even when the light source is specified. To fix the color temperature of the light source, use [11. WB Adjustable Range] in the [C2] menu. (📖 p.R31)
- To set the white balance setting when using the flash, use [10. WB When Using Flash] in the [C2] menu. (📖 p.R31)

## Setting the Manual White Balance

You can save up to three manual white balance settings.

1 Select  in the [White Balance] screen and press the ► key.

2 Use the ▲▼ keys to select ,  or  and press the ► key.

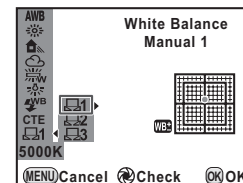

3 Aim the camera at the subject to measure the white balance and press the shutter release button fully.

4 Use the  dial to select the entire screen or spot area for the measuring range.

When a spot area is selected, use the ▲▼◀▶ keys to move the frame to the position you want to measure.

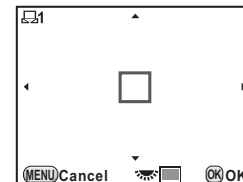



5 Press the OK button.

When measuring is completed, the camera returns to the white balance fine-tuning screen.



## Setting the Color Temperature

You can save up to three color temperature settings. (The default setting is [5000K].)

- 1 Select **K** in the [White Balance] screen and press the **▶** key.
- 2 Use the **▲ ▼** keys to select K1, K2 or K3 and press the **▶** key.  
The [Color Temperature] screen appears.
- 3 Use the  /  dials to adjust the color temperature.

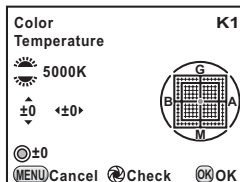
Color temperature steps differ depending on the e-dial.



e-dial	Kelvin	Mired
	1 Step (100K)	1 Step (20M)
	10 Steps (1,000K)	5 Steps (100M)

### 4 Press the OK button.





The settings are saved and the camera returns to the [White Balance] screen.

#### Memo

- By default, the unit of Color Temperature is [Kelvin]. You can change the unit to [Mired] in [22. Color Temperature Steps] in the [C4] menu. (Figures are converted to Kelvin and displayed.) (p.R33)

## Saving the White Balance Setting of a Captured Image

You can copy the white balance setting of an image captured with this camera and save it as Manual White Balance.

- 1 In Playback mode, display the image with the white balance setting you want to copy.
- 2 Select  (Save as Manual WB) in the playback mode palette.
- 3 Select ,  or , and press the OK button.

The white balance setting of the selected image is saved to Manual White Balance and the camera switches to Capture mode.

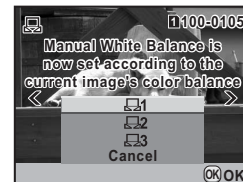

#### Caution

- The fine-tuned white balance value used when shooting is reset.

#### Memo

- Refer to “Setting the Playback Functions” (p.66) for operations of the playback mode palette.

# Drive Mode

There are four drive modes: Single Frame Shooting, Continuous Shooting, Self-timer, and Remote Control.

## 1 Press the DRIVE button.

The [Drive Mode] screen appears.

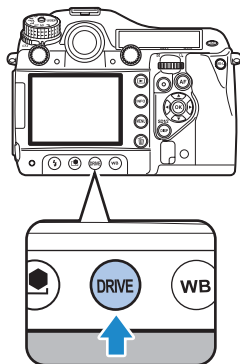

## 2 Use the ◀▶ keys to select a drive mode.

## Continuous Shooting

With Continuous Shooting, you can shoot at a maximum speed of 1.1 frames per second. The number of frames that can be shot continuously varies depending on the number of recorded pixels, quality level, and other settings.

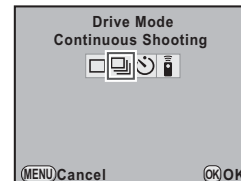

## 1 Select in the [Drive Mode] screen and press the OK button.





## 3

## Self-timer Shooting

This camera has the following two types of self-timer modes.

	Shutter is released after about 12 seconds.
	Mirror is raised and shutter is released after about 2 seconds.

**1** Select  in the [Drive Mode] screen.

**2** Press the **▼** key, use the **◀▶** key to select  or , and press the **OK** button.

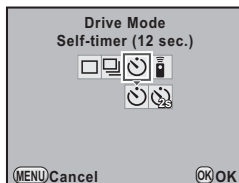



**3** Press the shutter release button fully.



When  is selected, the self-timer lamp on the front of the camera starts blinking slowly and blinks rapidly 2 seconds before the shutter is released. A beep is heard and the rate increases.

## Remote Control Shooting

This camera has the following three types of remote control shooting modes for use with the optional Remote Control F or Remote Control Waterproof O-RC1.

	Releases shutter immediately.
	Mirror is raised and shutter is released after 3 seconds.
	Continuous shooting starts when the shutter release button on the remote control unit is pressed. Press it again to stop shooting.

**1** Select  in the [Drive Mode] screen.

**2** Press the **▼** key, use the **◀▶** key to select , , or , and press the **OK** button.

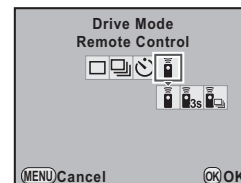

The self-timer lamp blinks.



### Memo

- When using the Remote Control Waterproof O-RC1, you can use the  button on the remote control to enable autofocus.

## Interval Shooting

By specifying the shooting time and interval, you can capture up to 999 images with Interval Shooting. Set this in the [2] menu. ( p.R17)

### Caution

- Interval Shooting is not available when the exposure mode is set to **B** or when Extended Bracketing or HDR Capture is set.



## Multi-exposure

You can create a composite picture by taking multiple frames. Set this in the [M2] menu. (📖 p.R17)

### ⚠ Caution

- When Multi-exposure is set, Interval Shooting and Extended Bracketing are not available.
- Multi-exposure cannot be used with Extended Bracketing or HDR Capture at the same time. The mode set last is used.
- [Lens Correction] in the [M2] menu is disabled when Multi-exposure is set.

## Mirror Lock-up

This raises the mirror. You can use this function with another drive mode.

### 1 Turn the MUP dial.

The camera is ready to raise the mirror.

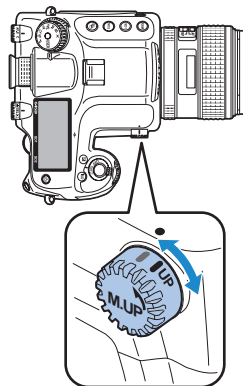

### 2 Press the shutter release button fully.

The mirror is raised.

### 3 Press the shutter release button fully again.

The picture is taken and the mirror is lowered.

To exit mirror lock-up shooting, return the **MUP** dial to its original position.

### 📌 Memo

- The mirror will be lowered automatically about one minute after being raised.

### ⚠ Caution

- Turning the mode dial or adjusting the lens aperture ring when the mirror is raised lowers the mirror.
- Preview is not available when the mirror is raised.
- The mirror will not be raised during Interval Shooting even when the **MUP** dial is set to the "UP" position.

# Auto Bracketing

## Exposure Bracketing

You can use Exposure Bracketing to take 2 (standard exposure and underexposure, or standard exposure and overexposure), 3 or 5 pictures with different exposure.

### Memo

- Set the auto bracketing order with [8. Auto Bracketing Order] in the [C2] menu. (p.R31)
- Set the EV step interval with [1. EV Steps] in the [C1] menu. (p.R30)

## 1 Turn the dial while pressing the button and set the number of frames.

Check the setting on the LCD panel.

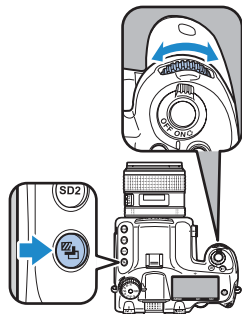

Right (clockwise)  
Left (counterclockwise)

OFF → 3 frames → 5 frames  
OFF → 2 frames (underexposed) →  
2 frames (overexposed)

## 2 Turn the dial while pressing the button and set the compensation value.

Press the button while pressing the button to return to [OFF] and [-].

EV Steps	Compensation Value
1/3 EV	$\pm 0.3/\pm 0.7/\pm 1.0/\pm 1.3/\pm 1.7/\pm 2.0$
1/2 EV	$\pm 0.5/\pm 1.0/\pm 1.5/\pm 2.0$

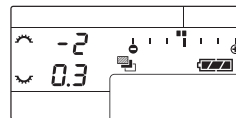

2 images (underexposed) at 0.3 EV

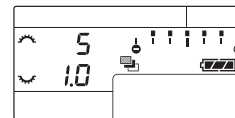

5 images at 1.0 EV

## 3 Press the shutter release button fully.

Pictures can be taken continuously while the shutter release button is held down.

If you take your finger off the shutter release button before the set number of frames is taken, the next bracket setting will remain effective for twice the amount of the exposure lock time.

Select [OFF] in Step 1 to finish shooting with Exposure Bracketing.

### Memo



- To take all frames with one press of the shutter release button, set [7. One-Push Bracketing] in the [C1] menu. (p.R30)
- You can combine Exposure Bracketing with the P-TTL auto flash to change the flash output continuously. Confirm that the flash unit is fully charged before shooting each frame.
- You can use Exposure Bracketing together with Extended Bracketing. When Extended Bracketing is set to 3 frames, a total of 9 images are saved.

### Caution

- This function is not available when the exposure mode is set to **B**.
- This function cannot be used with Multi-exposure. The mode set last is used.

## Extended Bracketing

You can take pictures with three different levels of the following items: White Balance, Saturation, High/Low Key Adjustment, Contrast and Sharpness. Unlike Exposure Bracketing, three pictures are saved each time the shutter is released.

Set this on the control panel or in the [2] menu. ( p.R16)

### Caution

- The file format is always set to [JPEG] and cannot be changed. You cannot use Extended Bracketing when the file format is set to [RAW] or [RAW+].
- When Extended Bracketing is set, Interval Shooting and Multi-exposure are not available.
- Extended Bracketing and HDR Capture cannot be used at the same time. The mode set last is used.

# Flash Mode

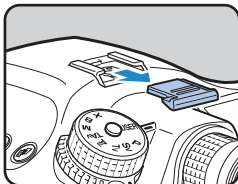

## Attaching a Flash

- 1 Remove the hot shoe cover of the camera.



- 2 Attach the flash and turn on the camera.

### Memo

- Press the  button to discharge the flash in Modeling Flash or Test Flash mode. Set this with [34. External Flash Discharge] in the [C5] menu. (  p.R35)

## Using a Sync Cord

You can connect a sync cord to the X-sync socket on the camera.

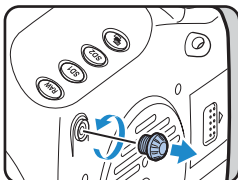





### Caution

- Do not use high-voltage or high-current external flashes. They may cause the camera to malfunction.
- A flash with reversed polarity (the center of the hot shoe or sync plug has a negative symbol) cannot be used, as this may damage the camera or flash.
- Linked functions will not work.
- To prevent vignetting caused by Trailing Curtain Sync from occurring, it is recommended to take a test shot using a shutter speed one stop slower than the flash sync speed.
- The contact of the X-sync socket is not dust-proof or water-resistant. Attach the provided Sync socket 2P cap when not in use.



## Setting the Flash Mode

The following flash modes are available. The flash modes that are available differ depending on the exposure mode.

Flash Mode	Available Exposure Modes
 Flash On	<b>P/Sv/Tv/Av/TAv/M/B/X</b>
 Flash On+Red-eye Reduction	
 Slow-speed Sync	<b>P/Sv/Av</b>
 Slow-speed Sync+Red-eye	

**1 Press the  button.**

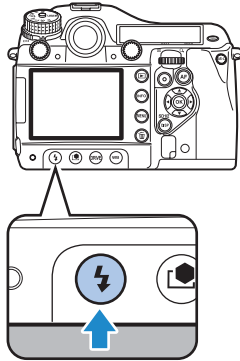
The [Flash Mode] screen appears.

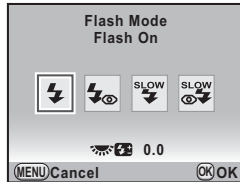
**2 Use the   keys to select a flash mode.****3 Use the  dial to adjust the flash compensation value.**

The compensation value differs depending on the setting of [1. EV Steps] ( p.R30) in the [C1] menu.

EV Steps	Compensation Value
1/3 EV	-2.0/-1.7/-1.3/-1.0/-0.7/-0.3/0.0/+0.3/+0.7/+1.0
1/2 EV	-2.0/-1.5/-1.0/-0.5/0.0/+0.5/+1.0

Press the  button to return to "0.0".

**4 Press the OK button.**

The camera switches to Capture mode.

# Flash Compatibility Chart

The following functions are available when using **645D** with PENTAX flashes.

(✓: Available ×: Not available)

Function	Flash								
	AF540FGZ AF360FGZ	AF200FG	AF160FC	AF500FTZ AF330FTZ	AF400FTZ AF240FT	AF400T AF280T AF200T	AF140C AF080C	AF200SA	AF200S AF160 AF140
P-TTL auto flash	✓ <sup>*3</sup>	✓ <sup>*3</sup>	✓ <sup>*3</sup>	×	×	×	×	×	×
TTL auto flash	×	×	×	×	×	×	×	×	×
External auto flash	✓	×	×	×	×	✓	×	✓	✓
Red-eye reduction	✓	✓	✓	×	×	×	×	×	×
Automatic switching of shutter speed to Flash X-sync Speed after flash charging	✓	✓	✓	✓	✓	✓	✓	✓	✓
Aperture set in <b>P</b> and <b>Tv</b> modes	✓	×	×	×	×	✓ <sup>*4</sup>	✓ <sup>*4</sup>	×	✓ <sup>*5</sup>
Slow-speed Sync	✓	✓	✓	✓	✓	✓ <sup>*6</sup>	✓ <sup>*6</sup>	✓	✓ <sup>*5</sup>
Auto check in the viewfinder	×	×	×	×	×	×	×	×	×
Trailing Curtain Sync <sup>*1</sup>	✓	×	×	✓ <sup>*7</sup>	✓ <sup>*7</sup>	×	×	×	×
Contrast-Control-Sync Flash	✓	×	×	×	×	×	×	×	×
Slave flash	✓	×	×	✓ <sup>*8</sup>	×	×	×	×	×
Flash compensation	✓	✓	✓	×	×	×	×	×	×
AF Assist Light	✓	×	×	✓	✓	×	×	×	×
Multiple flash	×	×	×	✓ <sup>*8</sup>	×	×	×	×	×
High-speed flash sync	✓	×	×	×	×	×	×	×	×
Wireless flash <sup>*2</sup>									

\*1 There is a limit to the available shutter speed.

\*2 Two or more compatible flash units are required.

\*3 Available only when using A645, A★645, FA645, FA★645, or D FA645 lenses.

\*4 When the flash setting is MS or M, the aperture value changes automatically.

\*5 When the flash setting is MS or M, the aperture value changes automatically in **Tv** mode.

\*6 The aperture value changes automatically.

\*7 The flash fully discharges.

\*8 Unavailable for AF330FTZ.

# Preview

There are two preview methods: Optical Preview (default setting) using the viewfinder and Digital Preview using the monitor.

## Optical Preview

- 1 Turn the main switch to  while viewing the subject through the viewfinder.

You can preview the depth of field in the viewfinder while the main switch is set to .

During this time, no shooting information is displayed in the viewfinder, and the shutter cannot be released.

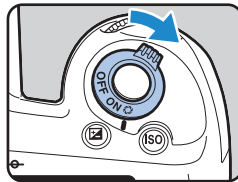

- 2 Take your finger off the main switch.

Optical Preview ends and the camera is ready to take a picture.

## Digital Preview

- 1 Set [Digital Preview] in the [M/3] menu.

Refer to "Menu Reference". ( p.R18)

- 2 Turn the main switch to  while viewing the subject on the monitor.

A preview appears on the monitor.

### Available operations

 dial	Enlarge Instant Review (p.67)
AE-L button	Saves the preview image as a new file.

- 3 Press the shutter release button halfway.

Digital Preview ends and the autofocus system operates.

-  Memo

- The maximum display time for Digital Preview is 60 seconds.

# Custom Image

You can set the image finishing tone before shooting. Select from the following eight modes for Image Tone: Bright, Natural (default setting), Portrait, Landscape, Vibrant, Muted, Reversal Film and Monochrome. You can adjust the following parameters for each mode.

Parameter	Setting
Saturation *1	-4 to +4
Hue *1	-4 to +4
Filter Effect *2	None/Green/Yellow/Orange/Red/Magenta/Blue/Cyan/Infrared Filter
Toning *2	-4 to +4
High/Low Key Adj*3	-4 to +4
Contrast *3	-4 to +4 • [Contrast Highlight] and [Contrast Shadow] can be added to make more advanced settings.
Sharpness	-4 to +4 • You can change [Sharpness] to [Fine Sharpness].

\*1 Not available when [Reversal Film] or [Monochrome] is selected.

\*2 Available only when [Monochrome] is selected.

\*3 Not available when [Reversal Film] is selected.

## 1 Press the button.

The [Custom Image] setting screen appears.

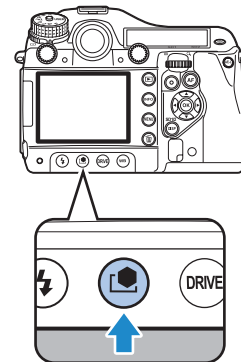

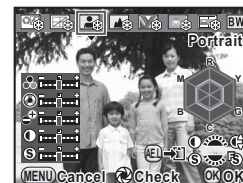

## 2 Use the ◀ ▶ keys to choose the image tone mode.

## 3 Use the ▲ ▼ keys to select the parameter you want to change and use the ◀ ▶ keys to change the setting.



### Available operations

 dial	Switches between enabling and disabling the more advanced setting for contrast.
 dial	Switches between [Sharpness] and [Fine Sharpness].
Main switch (↻)	Displays the background image with Digital Preview.
AE-L button	Saves the background image as a new file.



#### 4 Press the OK button.

The camera switches to Capture mode.

#### Memo

- The Custom Image settings of a JPEG image can also be adjusted after shooting. Immediately after shooting, press the  button and change the setting, and then press the **AE-L** button and select [Save as].
- When [Reversal Film] is selected and [White Balance] is set to **AWB**, images are captured with an effect similar to using a daylight film.





# 4

## Playback and Processing Functions

Setting the Playback Functions .....	66
Displaying a Single Image .....	67
Displaying Multiple Images .....	68
Developing RAW Images .....	72
Protecting Images .....	73
Rotating Images .....	74
Changing the Image Size .....	75
Digital Filters .....	76
DPOF Settings .....	78
Connecting the Camera to AV Equipment .....	79

# Setting the Playback Functions

Perform settings related to playing back images in the playback mode palette or  menu.

- 1 In Playback mode, display the image to play back and press the  key.

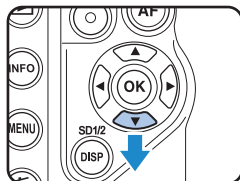











The playback mode palette appears.



## Memo

- If captured images are saved on both SD Memory Cards in the SD1 or SD2 slots, you can use the **DISP** button, **SD1** button, or **SD2** button to select the card containing the images to be played back.
- Refer to "Menu Reference" for details on the  menus. ([📖](#) p.R22)

## Playback Mode Palette

Item	Function	Page
 Image Rotation	Rotates images.	p.74
 Digital Filter	Changes the color tone of images, processes the image or adjusts the brightness.	p.76
 Resize	Changes the number of recorded pixels and quality level of images.	p.75
 Cropping	Crops images.	p.75
 Slideshow	Plays back images one after another.	p.70
 Save as Manual WB	Copies the white balance setting of an image and saves it as Manual White Balance.	p.52
 RAW Development*	Converts RAW images to JPEG format.	p.72
 Index	Joins a number of images together and creates a new index image with them.	p.71
 Image Comparison	Displays two images side-by-side.	p.70
 Protect	Protects images.	p.73
 DPOF	Sets the DPOF settings.	p.78

\* This cannot be performed for JPEG images.

## Saving edited images

When saving images that have been edited with Digital Filter, Resize, Cropping, RAW Development, or Index, you can choose whether to save the images to the SD Memory Card in the SD1 or SD2 slot if both cards are available for recording.

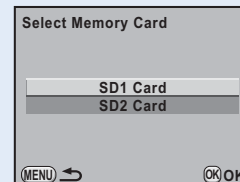

# Displaying a Single Image

## Deleting Images One by One

### Caution

- Deleted images cannot be restored.
- Protected images cannot be deleted. (p.73)

### 1 Select the image you want to delete and press the button.

The delete screen appears.

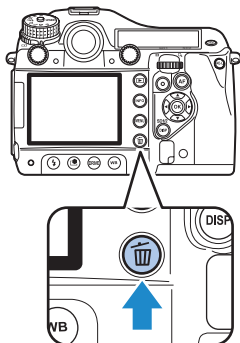

### 2 Use the keys to select [Delete] and press the OK button.

### Memo

- Select the file format to delete for the images saved in RAW+ format.
- When deleting multiple images at once, refer to “Multi-image Display” (p.68) and “Folder Display” (p.69).
- To delete all images, use [Delete All Images] in the [▶1] menu. (p.R22)

## Zoom Display









Images can be magnified up to 3200% in Playback mode.

### 1 Select the image to enlarge and turn the dial to the right (.

The image enlarges at each click ([ $\times 1.2$ ] (120%) to [ $\times 32$ ] (3200%)).



#### Available operations

 keys	Moves the area to enlarge.
 dial to the right (  )/  button	Enlarges the image (up to 3200%).
 dial to the left (  )/  button	Reduces the image (down to 120%).
<b>OK</b> button	Returns to the original size.
 dial	Displays the previous or next image without changing the magnification and the position of the enlarged image.
<b>INFO</b> button	Changes the information display.
<b>DISP</b> button/ <b>SD1</b> button/ <b>SD2</b> button	Switches between the SD Memory Cards without changing the magnification and the position of the enlarged image.

### Memo

- You can enlarge the image by following the same procedure during Instant Review (p.37) or Digital Preview (p.61).
- The default setting for the initial magnification is [ $\times 1.2$ ] (120%). You can set the initial magnification with [Playback Display Method] in the [▶1] menu. (p.R22)
- The full display of vertical images is displayed at three-quarters the size of horizontal images; therefore, the initial enlarged magnification of vertical images is 100%.

# Displaying Multiple Images

## Multi-image Display

You can display 4, 9 (default setting), 16, 36 or 81 images on the monitor at the same time.

### 1 Turn the dial to the left (M) in Playback mode.

Nine thumbnail images are displayed at once.

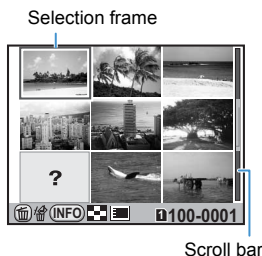

#### Available operations

▲▼◀▶ keys	Moves the selection frame.
OK button	Displays a full screen display of the selected image.
INFO button	Displays the [Multi-imp Display Setting] screen. Select the number of images to display at the same time.



(This is not available when developing multiple RAW images (p.72).)

DISP button/ SD1 button/ SD2 button	Switches between the SD Memory Cards.
🗑 button	Selects the images and deletes them.

### Memo

- Icons such as ? are not displayed on the thumbnail images during 81-image display.

## Select & Delete

You can delete up to 100 images at once.

### 1 In the multi-image display screen, press the button.

During 81-image display, the screen temporarily changes to 36-image display.



### 2 Select the images to delete.

#### Available operations

▲▼◀▶ keys	Moves the selection frame.
OK button	Selects (✓) or deselects an image.
 dial	Displays the selected image at full screen. (◀▶ keys: Displays the next or previous image.)

### 3 Press the button and select [Select & Delete].

## Folder Display

Images will be grouped and displayed by folder in which they are saved.

- 1 In the multi-image display screen, turn the dial again to the left (☂).

Six folders are displayed at once.

- 2 Select the folder to display.

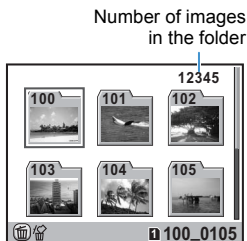

### Available operations

▲▼◀▶ keys	Moves the selection frame.
OK button	Displays the images in the folder on the multi-image display screen.
DISP button/SD1 button/SD2 button	Switches between the SD Memory Cards.
🗑️ button	Deletes the folder and all the images in it.

### Memo

- If the folder to be deleted contains protected images, select whether to delete or leave all images on the confirmation screen. When [Delete All] is selected, protected images are also deleted.
- Refer to “Menu Reference” for details on folder names. (📖 p.R26)

## Calendar Display

You can display images by shooting date.

- 1 In the multi-image display screen, press the INFO button twice.

Only the dates when pictures were taken are displayed.

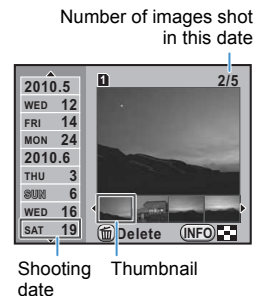

### Available operations

▲▼ keys	Selects the shooting date.
◀▶ keys	Selects an image captured on the selected shooting date.
OK button or ☂ dial to the right (☉)	Displays all images. (☂ dial to the left (☒): Returns to calendar display.)
INFO button	Switches to Multi-image display.
DISP button/SD1 button/SD2 button	Switches between the SD Memory Cards.
🗑️ button	Deletes selected images.

## Slideshow

You can play back all images saved on an SD Memory Card successively.

### 1 Select (Slideshow) in the playback mode palette.

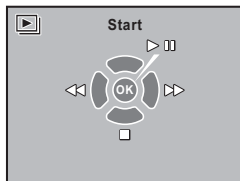

The start screen is displayed and slideshow begins.



#### Available operations

<b>OK</b> button	Pause/Resume
<b>◀▶</b> keys	Displays the next or previous image.
<b>▼</b> key/ <b>▶</b> button/ <b>MENU</b> button	Stops playback and the camera returns to Playback mode.
Shutter release button/ <b>AF</b> button/Mode dial switching/Main switch (  )	Stops playback and the camera switches to Capture mode.

### Memo

- If captured images are saved on both SD Memory Cards in the SD1 and SD2 slots, the slideshow displays the images of the card containing the image last played back. You cannot switch to the other SD Memory Card.
- You can set the slideshow display method with [Slideshow] in the [1] menu. ( p.R22)

## Image Comparison



You can display two images side-by-side.

### 1 Select (Image Comparison) in the playback mode palette.

The last image played back will be displayed twice side-by-side.



#### Available operations

<b>OK</b> button	Moves the selection frame (right image → both images → left image).
<b>▲▼◀▶</b> keys	Moves the area to enlarge.
<b>◎</b> button	Returns the enlarged area to the center.
 dial	Displays the previous or next image (when the selection frame is on the left or right image).
 dial	Enlarges or reduces the image.
<b>INFO</b> button	Changes the information display.
<b>DISP</b> button/ <b>SD1</b> button/ <b>SD2</b> button	Switches between the SD Memory Cards (when the selection frame is on the left or right image).
 button	Deletes the image (when the selection frame is on the left or right image).
<b>MENU</b> button	Returns to single image display.



## Index





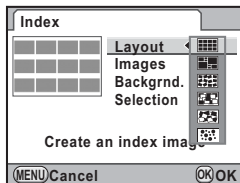

You can join multiple images together, display them as an index print, and save the index print as a new image.

### 1 Select (Index) in the playback mode palette.

The [Index] screen appears.

### 2 Press the key and select a layout.



 Thumbnail	 Random2
 Square	 Random3
 Random1	 Bubble

When you select , images are positioned in order starting from the smallest file number.



### 3 Select [Images], press the key, and select the number of images.

You can select 12, 24 or 36 images.

### 4 Select [Backgrnd.], press the key, and select the background color.

You can select a white or black background.



### 5 Select [Selection], press the key, and select the type of image selection.

 All Images	Automatically selects all images from the SD Memory Card containing the image last displayed.
 Manual	Lets you select the images individually. Continue by selecting [Select image(s)] and select the individual images.
 Folder	Automatically selects images from the selected folder. Continue by selecting [Select a folder] and select the folder.

### 6 Select [Create an index image].

After the message [Data being processed] appears, the index image is displayed.

### 7 Select [Save] or [Reshuffle].

Save	The index image is saved with [Recorded Pixels] set to  and [Quality Level] set to  .
Reshuffle	Reselects the images and displays a new index image. (If [Thumbnail] is selected for [Layout], this is not displayed.)

After the index image is saved, the camera returns to Playback mode and the index image is displayed.

### Memo

- Processing may take a while when creating an index image.
- When the number of saved images is smaller than the number set for [Images], empty spaces will appear in [Thumbnail] layout and some images may be duplicated in other layouts.

# Developing RAW Images

You can convert RAW images into JPEG or TIFF format.

## Caution

- Only RAW images captured with this camera can be edited. Images captured with other cameras cannot be edited on this camera.

## 4

### Playback and Processing Functions

### 1 Select a RAW image and select **RAW** (RAW Development) in the playback mode palette.

### 2 Select [Developing a Single Image] or [Developing Multiple Images].

If [Developing a Single Image] is selected, the parameters recorded in the image file are displayed. You can turn the  dial to select a different image. Proceed to Step 5.

If [Developing Multiple Images] is selected, the display is switched to Multi-image Display (p.68).

### 3 Select the RAW images to develop.

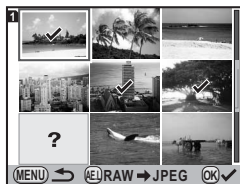

### 4 Press the AE-L button and select [Develop images as shot] or [Develop images with modified settings].







### 5 Use the **▲ ▼** keys to select the parameter and use the **◀ ▶** keys to adjust the value.



If you select [Develop images as shot] in Step 4, you can set only File Format, Recorded Pixels and Quality Level.

Press the **▶** key to display the setting screen for White Balance and Custom Image.

Parameter	Value	Page
File Format	JPEG/TIFF	–
Recorded Pixels <sup>*1</sup>	40m (7264×5440)/32m (6528×4896)/ 21m (5376×4032)/13m (4224×3168)/ 7m (3072×2304)	p.43
Quality Level <sup>*1</sup>	★★★★/★★★/★★	p.43
Custom Image	Bright/Natural/Portrait/Landscape/ Vibrant/Muted/Reversal Film/ Monochrome	p.62
White Balance <sup>*2</sup>	AWB (Auto)/☀ (Daylight)/☷ (Shade)/☁ (Cloudy)/☷D (Fluorescent Light Daylight Color)/ ☷N (Fluorescent Light Daylight White)/☷W (Fluorescent Light Cool White)/☷L (Fluorescent Light Warm White)/☷ (Tungsten Light)/☷WB (Flash)/CTE/☷ (Manual 1 to 3)/K (Color Temperature 1 to 3)	p.50
Sensitivity	–2.0 to +2.0	–
High-ISO Noise Reduction	Off/Low/Medium/High	 p.R32
Shadow Correction	Off/Low/Medium/High	 p.R14
Distortion Correction <sup>*3</sup>	Off/On	 p.R15

Parameter	Value	Page
Lat-Chromatic-Ab Adj <sup>*3</sup>	Off/On	 p.R15
Color Space	sRGB/AdobeRGB	 p.R19

\*1 This cannot be set when [File Format] is set to [TIFF]. (The setting is fixed to )

\*2 This cannot be set for RAW images taken in Multi-exposure mode.

\*3 This can be selected only when a compatible lens is attached.

## 6 Press the OK button.

## 7 Select [Save as].

If you selected [Developing a Single Image] in Step 2, the message [Image developed and stored. Continue developing?] appears.

Select [Continue] to develop other RAW images.

### Memo



- You cannot save the background image or use Digital Preview with Custom Image or White Balance.
- When [White Balance] is set to  (Manual), press the **INFO** button to display the measuring screen.

# Protecting Images

You can protect images from being accidentally deleted.

## 1 Select (Protect) in the playback mode palette.

## 2 Select [Single Image] or [All Images].

If [Single Image] is selected, use the   keys to select an image to protect.

## 3 Select [Protect] or [Unprotect].

If [Protect] is selected, the image is protected and the  icon appears at the top right of the screen. If [Unprotect] is selected, the protection is removed.

### Caution

- When an SD Memory Card is formatted, all images including protected images are deleted.

# Rotating Images

When shooting vertically, rotation information is added to an image so that it can be played back with the appropriate orientation. You can change the rotation information and save the image using the following procedure.

## Memo

- Images with rotation information are rotated and displayed according to the orientation of the camera. To cancel image rotation, set [32. Auto Image Rotation] in the [C5] menu to [Off]. ([p.R35](#))
- To not add rotation information, set [31. Saving Rotation Info] in the [C5] menu to [Off]. ([p.R35](#))

## Caution

- Rotation information cannot be changed in the following situations.
  - For protected images
  - For images without rotation information
  - When [32. Auto Image Rotation] in the [C5] menu is set to [Off] ([p.R35](#))

## 1 Select the image to rotate and select (Image Rotation) in the playback mode palette.

Four thumbnail images are displayed with the image rotated in 90° increments.

## 2 Use the keys to select the desired rotation direction and press the OK button.

The image rotation information is changed.

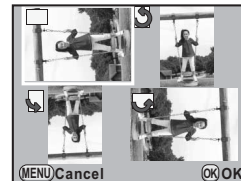

# Changing the Image Size

## Resizing Images

You can change the number of recorded pixels and quality level of an image and save it as a new file.

### Caution

- Only JPEG images captured with this camera can be resized.
- Images once resized to 1.9M cannot be resized again.

**1** Select the image to resize and then select  (Resize) in the playback mode palette.

**2** Select the image size.

Select from 36M, 32M, 28M, 25M, 21M, 18M, 16M, 13M, 11M, 7M and 1.9M. (The available sizes differ depending on the original image size.)

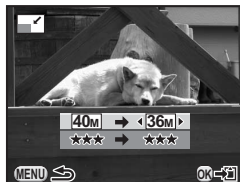

**3** Select the quality level and press the OK button.

**4** Select [Save as].

## Cropping Images

You can crop an image and save it as a new file.

### Caution



- Only JPEG and RAW images captured with this camera can be cropped.
- Images resized to 7M or 1.9M with this camera cannot be cropped.

**1** Select the image to crop and then select  (Cropping) in the playback mode palette.

**2** Specify the size and position of the area to crop by using the cropping frame that appears on the screen.



### Available operations

 dial	Changes the size of the cropping frame.
 keys	Moves the cropping frame.
INFO button	Rotates the image from -45° to +45° in increments of 1°.
 button	Rotates the cropping frame in 90° increments (only when the cropping frame can be rotated).

**3** Press the OK button.

**4** Select [Save as].

# Digital Filters

You can process images with digital filters.  
The following filters are available.

Filter name	Effect	Parameter
Monochrome	Creates a monochrome image.	Filter Effect: OFF/Red/Green/Blue/IR (Infrared Filter) Toning (B-A): 7 levels
Extract Color	Extracts a specific color and makes the rest of the image black and white.	Color: Red/Magenta/Blue/Cyan/Green/Yellow Color Freq. Range: -2 to +2
Color	Adds a color filter to the image.	Color: Red/Magenta/Blue/Cyan/Green/Yellow Color Density: Light/Standard/Dark
Base Parameter Adj	Adjusts the parameters to create the desired image.	Brightness: ±8 levels
		Saturation: ±3 levels
		Hue: ±3 levels
		Contrast: ±3 levels
Soft	Creates an image with a soft focus throughout the image.	Sharpness: ±3 levels
		Soft Focus: +1/+2/+3 Shadow Blur: OFF/ON

## Caution

- Only JPEG and RAW images captured with this camera can be edited using the digital filters.

## Applying the Digital Filter

**1** Select an image for applying the digital filter and then select **0** (Digital Filter) in the playback mode palette.

**2** Use the **▲ ▼** keys to select a filter and press the **OK** button.

You can check the filter effect on the screen.

You can also use the  dial to select a different image.



**3** Use the **▲ ▼** keys to select the parameter, use the **◀ ▶** keys to adjust the value, and press the **OK** button.

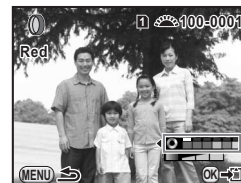

Example: Color Filter

**4** Select **[Use filters in combination]** or **[Save as]**.

The image is saved.

To apply additional filters to the same image, select **[Use filters in combination]** and repeat Steps 2 to 4.

## Memo

- You can apply up to 10 filters to the same image.

## Recreating Filter Effects

You can retrieve the filter effects already applied to an image, and reapply them to other images.

**1** Select an image for retrieving the digital filter effects and then select **0** (Digital Filter) in the playback mode palette.

**2** Select [Recreating filter effects] and press the **OK** button.

The filter effects applied to the image appears.

Press the **INFO** button to check the filter parameters.

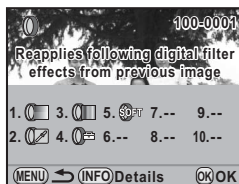

**3** Use the **◀ ▶** keys to select an image for applying the same filter effects and press the **OK** button.

You can only select an image that has not been processed with a filter.

**4** Select [Save as].

## Searching for the Original Image

You can search for and display the original image prior to digital filter application.

**1** Select [Searching for the original image] in Step 2 in “Recreating Filter Effects”.

### Memo

- If the original image is no longer stored on the SD Memory Card, the message [Original image, prior to digital filter application, is not found] appears.

# DPOF Settings

DPOF (Digital Print Order Format) settings allow you to specify the number of copies and whether to imprint the date.

## Memo

- DPOF settings cannot be applied to RAW images.
- You can make DPOF settings for up to 999 images on each SD Memory Card.

**4 1** Select  (DPOF) in the playback mode palette.

**2** Select [Single Image] or [All Images].

If [All Images] is selected, proceed to Step 4.

**3** Use the ◀ ▶ keys to select an image to set DPOF settings.

**4** Use the ▲ ▼ keys to select the number of copies.

You can set up to 99 copies.

To cancel the DPOF setting, set the number of copies to [00].



**5** Turn the  dial to select  or  for printing the date.

- : The date will be printed.
- : The date will not be printed.

Repeat Steps 3 to 6 to set other images.

**6** Press the OK button.

The DPOF settings are saved.

## Caution

- You cannot switch between the SD Memory Cards while making the DPOF settings.
- Depending on the printer, the date may not be printed even if you select  in Step 5.
- The number of copies specified for the All Images setting applies to all the images, and the Single Image setting is canceled.



# Connecting the Camera to AV Equipment

You can play back images on AV equipment by connecting the camera with a commercially-available video cable (mini plug to RCA cable) or HDMI cable (Type C).

## Memo

- If you intend to play back continuously for a long period, use of the AC adapter kit K-AC50 (optional) is recommended. (p.30)
- Nothing is displayed on the monitor during HDMI output.
- You cannot output both composite and HDMI video signals at the same time.
- The video output format differs depending on the region. When you set the hometown with Initial Settings (p.34) or change [Setting the Time] to → (Destination) with [World Time] (p.R23) in the [1] menu, the video output format is set to match that region. If images fail to be played back, change the video output format with [Video Out] in the [2] menu. (p.R25)
- The maximum size of the HDMI output format corresponding to the AV equipment and camera is automatically selected. If images fail to be played back, change the video output format with [HDMI Out] in the [2] menu. (p.R25)

## About the Video Cable

The video terminal for this camera is a two-conductor socket. If using a three- or four-conductor mini plug cable, insert the colored cord corresponding to the signal from the mini plug end into the video input terminal on the AV equipment being used.

[3-conductor mini plug]

Video signal from the  
**645D**

Earth (GND)

[4-conductor mini plug]

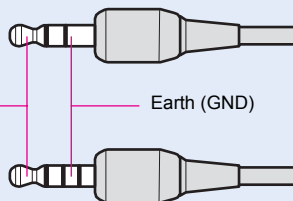

- 1 Turn the AV equipment and camera off.
- 2 Open the terminal cover on the camera and connect the video cable to the video terminal or the HDMI cable to the mini HDMI terminal.

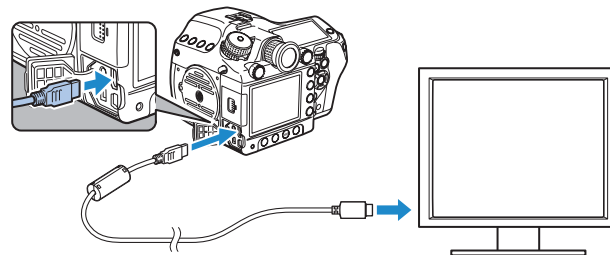

- 3 Connect the other end of the video cable or HDMI cable to the video IN jack or HDMI IN jack on the AV equipment, and then turn on the camera and AV equipment.

The camera turns on in video or HDMI mode, and the camera information is displayed on the screen of the connected AV equipment.

## Caution

- For video output, images are played back in normal resolution regardless of the compatible resolution of the AV equipment. To play back images in high definition, use the HDMI terminal or first transfer the data to a computer.

# MEMO

# 5

## Using a Computer

---

Connecting to a Computer .....	82
Using the Provided Software .....	84

# Connecting to a Computer

The captured images can be transferred to a computer by connecting the camera using a USB cable and can be managed using the provided software.

## System Requirements

We recommend the following system requirements to connect your camera to a computer or to use the software “PENTAX Digital Camera Utility 4” included on the CD-ROM (S-SW107).

### Windows

<b>OS</b>	Windows XP (SP3 or later), Windows Vista, or Windows 7 (can be run as a 32-bit application on any x64 Edition of Windows.)
<b>CPU</b>	Pentium D 3.0 GHz equivalent or higher (Intel Core 2 Duo processor 2.0 GHz equivalent or higher recommended)
<b>Memory</b>	2.0 GB minimum (3.0 GB or more recommended)
<b>Free disk space</b>	1 GB minimum (8 GB or more recommended)
<b>Monitor</b>	1280×800 pixels or more (1920×1200 or more recommended) with 24-bit full color (approximately 16.77 million colors)
<b>Others</b>	USB 2.0 port as standard equipment

### Macintosh

<b>OS</b>	Mac OS X 10.4.11, 10.5, or 10.6
<b>CPU</b>	PowerPC G5 Dual-core 2.0 GHz or higher (Intel Core 2 Duo processor 2.0 GHz or higher recommended. Universal Binary format.)
<b>Memory</b>	2.0 GB minimum (4.0 GB or more recommended)
<b>Free disk space</b>	1 GB minimum (8 GB or more recommended)
<b>Monitor</b>	1280×800 pixels or more (1920×1200 or more recommended) with 24-bit full color (approximately 16.77 million colors)
<b>Others</b>	USB 2.0 port as standard equipment, QuickTime 7.0 or later

## Connecting Your Camera to a Computer

### 1 Set [USB Connection] in the [**2**] menu.

Refer to "Menu Reference". (📖 p.R25)

### 2 Turn your computer on.

### 3 Turn your camera off.

### 4 Open the terminal cover of the camera, and connect the USB terminal and a USB port of your computer using the provided USB cable.

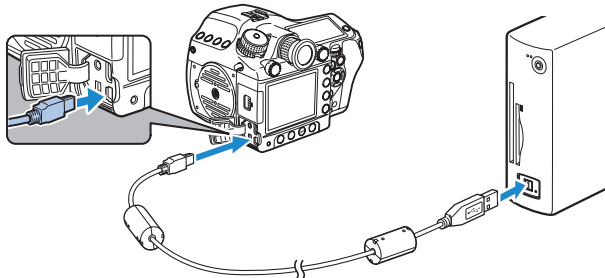

### 5 Turn your camera on.

For Windows, the camera is recognized as a [Removable Disk] in [My Computer].

For Macintosh, an icon for the SD Memory Card appears on the desktop.

### Memo

- If the [Removable Disk Drive] dialog appears when the camera is turned on, select [Open folder to view files using Windows Explorer] and click the OK button.
- When using Windows XP, if the SD Memory Card has a volume label, the volume label name appears instead of [Removable Disk]. A new unformatted SD Memory Card may show the manufacturer's name or model number.

### 6 Save the captured images to your computer.

Copy the image file(s) or the folder containing the image files in your camera to the hard disk of your computer.

### 7 Disconnect your camera from your computer.

# Using the Provided Software

“PENTAX Digital Camera Utility 4” is included on the provided CD-ROM (S-SW107). Using the PENTAX Digital Camera Utility 4, you can manage images saved on your computer, develop RAW images taken with this camera and adjust the color of them.

## Compatible file formats:

.bmp (BMP)/.jpg (JPEG)/.pef (RAW files in PENTAX original format)/.png (PNG)/.tif (TIFF)/.dng (RAW files in DNG format)

5

Using a Computer

## Installing the Software

You can install the software from the provided CD-ROM.

### Memo

- When multiple accounts have been setup on your computer, log on with an account that has administrative rights before installing the software.

### 1 Turn your computer on.

Shut down other software running.

### 2 Place the CD-ROM (S-SW107) into the CD-ROM/DVD drive on your computer.

The [PENTAX Software Installer] screen appears.

If the [PENTAX Software Installer] screen does not appear

#### [For Windows]

- 1 Click [My Computer] from the Start menu.
- 2 Double-click the [CD-ROM drive (S-SW107)] icon.
- 3 Double-click the [Setup.exe] icon.

#### [For Macintosh]

- 1 Double-click the CD-ROM (S-SW107) icon on the desktop.
- 2 Double-click the [PENTAX Installer] icon.

### 3 Click [PENTAX Digital Camera Utility 4].

For Windows, proceed to Step 4.

For Macintosh, follow the instructions on the screen to perform subsequent steps.



### 4 Select the desired language in the [Choose Setup Language] screen and click [OK].

### 5 When the [InstallShield Wizard] screen appears in the selected language, click [Next].

Follow the instructions on the screen to perform subsequent steps.

# The PENTAX Digital Camera Utility 4 Screen

When PENTAX Digital Camera Utility 4 is launched, the following screen (browser) appears.

## Memo

- The screenshots used in this explanation are for Windows.

## ● The Browser tab set (default setting)

You can perform the file management functions such as viewing and managing the images.

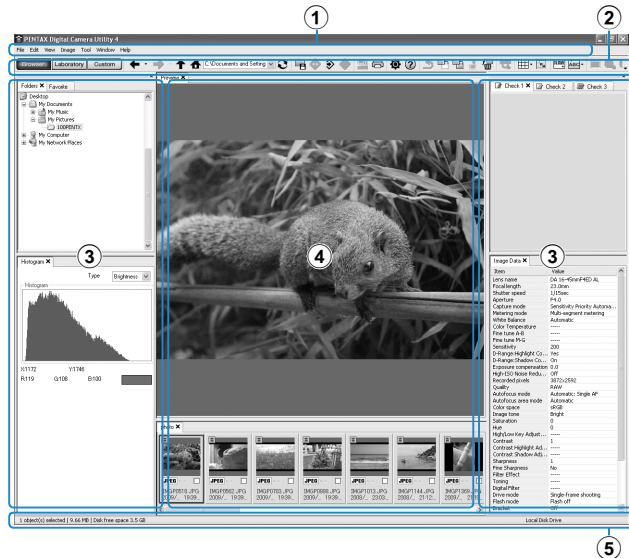

## ① Menu Bar

This executes functions or sets various settings.

For Macintosh, the Menu bar appears at the top of the desktop.

## ② Tool Bar

Frequently used functions are provided as Tool bar buttons.

## ③ Control Panel

The shooting information and settings for the selected image appear in this panel. You can switch the panel tab sets by pressing the Browser, Laboratory and Custom buttons on the Tool bar.

## ④ File Display Pane

The file list or the images in the selected folder appear here.

## ⑤ Status Bar

Information on the selected item appears.

## ● The Laboratory tab set (default setting)

The control panel for adjusting the image appears here.

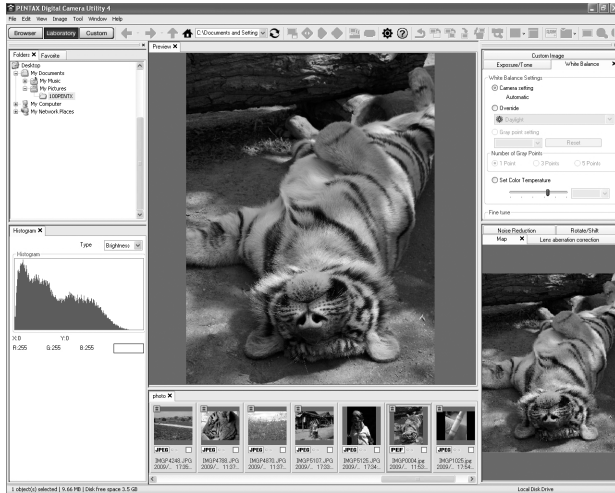

## ● The Custom tab set (default setting)

The screen display can be customized here.

The Custom tab set enables you to customize whether to show/hide the various tab pages in accordance with your needs. By default, all control panels are displayed.

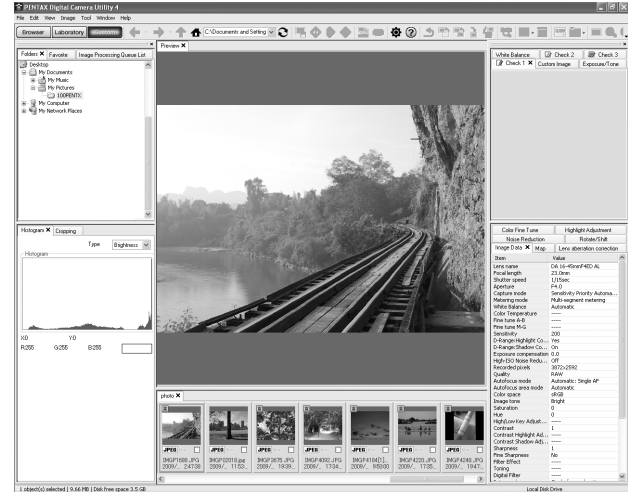



## Viewing the Help Menu

Refer to the Help menu for details on using the software program.

### 1 Click the button on the Tool bar.

Or, select [PENTAX Digital Camera Utility Help] from the [Help] menu.

## Regarding Product Registration

To better serve you, please take a moment to register your software.

### 1 Click [Product Registration] on the screen in Step 3 on p.84.

A world map for Internet Product Registration is displayed.



### 2 If your computer is connected to the Internet, click the displayed country or region and then follow the instructions to register your software.

Note that you can only register online if your country or area is shown.

# MEMO

# 6

## Appendix

---

<b>Optional Accessories .....</b>	<b>90</b>
<b>Error Messages .....</b>	<b>93</b>
<b>Troubleshooting .....</b>	<b>94</b>
<b>Index .....</b>	<b>95</b>
<b>WARRANTY POLICY .....</b>	<b>100</b>

# Optional Accessories

Several accessories are provided for use with the **645D**. Please contact a PENTAX Service Center for details regarding accessories.

Products marked with an asterisk (\*) are the same as those supplied with the camera.

## Power Supply Accessories

### Battery Charger kit K-BC90 (\*)

(Kit includes Battery charger D-BC90 and AC plug cord.)

### Rechargeable Lithium-ion Battery D-LI90 (\*)

### AC Adapter Kit K-AC50

(Kit includes AC Adapter D-AC50 and AC plug cord.)

Lets you power your camera from an AC outlet.

6

Appendix

## Flash Accessories

### Auto Flash AF540FGZ

### Auto Flash AF360FGZ

The AF540FGZ and AF360FGZ are P-TTL auto flash units with a maximum guide number of approximately 54 and 36 (ISO 100/m), respectively. Their features include slave-sync flash, contrast-control-sync flash, auto flash, high-speed sync flash, wireless flash, slow-speed sync and trailing curtain sync flash.



AF540FGZ



AF360FGZ

### Auto Flash AF200FG

The AF200FG is a P-TTL auto flash unit with a maximum guide number of approximately 20 (ISO 100/m).

It features contrast-control-sync flash and slow-speed sync flash when combined with the AF540FGZ or AF360FGZ unit.



AF200FG

### Auto Macro Flash AF160FC

The AF160FC is a flash system especially designed for macro photography to take close, shadowless pictures of small objects. It is compatible with existing TTL auto flash functions and it can be used with a wide range of PENTAX cameras by using the provided adapter rings.



AF160FC

### Hot Shoe Adapter FG

### Extension Cord F5P

### Off-camera Shoe Adapter F

Use the adapters and cords to use the external flash away from the camera.

### Off-camera Shoe Clip CL-10

When using the AF540FGZ or AF360FGZ as a wireless flash, this large clip is used for setting the external flash on a desk or table.



Hot Shoe Adapter FG



Off-camera Shoe Adapter F



Off-camera Shoe Clip CL-10

## For Viewfinder

### Large Eyecup 645 O-EC107 (\*)

## Interchangeable Focusing Screen

### AF Framed Matte DF-80 (\*)

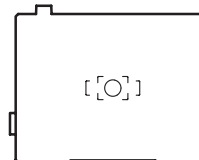

### AF Cross-Lined Matte DG-80

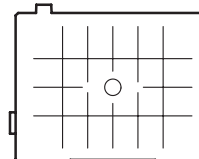

### AF Golden Section Matte DK-80

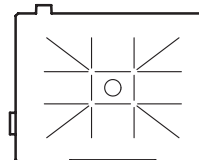

## Cable Switch CS-205

Connect to the cable switch terminal and operate the camera shutter release button. The cord length is 0.5 m.



## Remote Control

Used for remote control shooting.

Operating distance for remote control

From the front of camera: approx. 4 m

From the back of camera: approx. 2 m

### Remote Control F



### Remote Control Waterproof O-RC1



## GPS Unit O-GPS1

Attach this unit to the camera's hot shoe to record information such as the latitude, longitude, altitude, direction, and Coordinated Universal Time (UTC). Functions including Electronic Compass and Simple Navigation are also available.



### Caution

- In order to use the GPS unit, the camera's firmware must be updated to the latest version. Refer to the PENTAX website for details on updating the firmware.

## Strap

### Camera Strap O-ST107 (\*)

## Other Accessories

### Body Mount Cap 645 (\*)

### Hot Shoe Cover Fk (\*)

### USB Cable I-USB107 (\*)

### Sync Socket 2P Cap (\*)

### Imagesensor Cleaning Kit O-ICK1

# Error Messages

Error Message	Description
<b>Memory card full</b>	The SD Memory Card is full and no more images can be saved. Insert a new SD Memory Card or delete unwanted images.
<b>No image</b>	There are no images for playback on the SD Memory Card.
<b>This image cannot be displayed</b>	You are trying to play back an image in a format not supported by this camera.
<b>No card in the camera</b>	The SD Memory Card is not inserted in the camera.
<b>Cannot use this card</b>	The inserted SD Memory Card is not compatible with this camera.
<b>Memory card error</b>	The SD Memory Card has a problem, and image capture and playback are impossible.
<b>Card is not formatted</b>	The SD Memory Card you have inserted is unformatted or has been formatted on other device and is not compatible with this camera. Use the card after formatting it with this camera.
<b>Card is locked</b>	The write-protect switch on the SD Memory Card you have inserted is locked. Unlock the SD Memory Card.
<b>The card is electronically locked</b>	Data are protected by the SD Memory Card security feature.
<b>This image cannot be enlarged</b>	You are trying to enlarge an image that cannot be enlarged.
<b>This image is protected</b>	The image is protected. Remove the protection from the image.
<b>Battery depleted</b>	The battery is exhausted. Install a charged battery in the camera.

Error Message	Description
<b>Not enough battery power remaining to clean sensor</b>	Appears if the battery level is insufficient. Replace the battery with a fully charged one or use an AC adaptor kit K-AC50 (optional).
<b>Not enough battery power remaining to activate Pixel Mapping</b>	
<b>Image folder cannot be created</b>	The maximum folder number (999) and file number (9999) are being used, and no more images can be saved. Insert a new SD Memory Card or format the card.
<b>Unable to store image</b>	The image could not be saved because of an SD Memory Card error.
<b>Settings not stored</b>	The DPOF settings could not be saved because the SD Memory Card is full. Delete unwanted images and perform DPOF settings again.
<b>The operation could not be completed correctly</b>	The camera was unable to measure the manual white balance or detect dust on the sensor. Try the operation again.
<b>No more images can be selected</b>	You cannot select 100 or more images at a time for Index, Select & Delete or Developing Multiple RAW Images.
<b>This image cannot be processed</b>	Appears when Digital Filter, Resize, Cropping, Save as Manual WB, or RAW Development is started for images captured with other cameras, or when Resize or Cropping is started for minimum size images.
<b>The camera failed to create an image</b>	The creation of an index print image failed.

## Caution

- Error messages related to an SD Memory Card appear for each card slot being used. If an error message appears, take the appropriate action for the respective card slot.

# Troubleshooting

In rare cases, the camera may not operate correctly due to static electricity. This can be remedied by taking the battery out and putting it back in again. When the mirror remains in the up position, take the battery out and put it back in again. Then, the mirror will retract when the camera is turned on again. If, after performing these procedures, the camera operates correctly, it does not require any repairs.

We recommend checking the following items before contacting a service center.

Problem	Cause	Remedy
The camera does not turn on	The battery is not installed	Check if the battery is installed.
	The battery power is low	Replace with a charged battery or use the AC adapter kit K-AC50 (optional).
The shutter will not release	There is no available space on the SD Memory Card	Insert an SD Memory Card with available space or delete unwanted images. Also check the file format settings for the SD1 and SD2 slots.
	Recording	Wait until recording is finished.
The USB connection with a computer does not work properly	The USB connection mode is set to [PTP]	Set [USB Connection] in the [2] menu to [MSC]. (  p.R25)



# Index

## Symbols

⚡ button	59
📷 button	62
📱 button	56
📷 button	48
☀️ button	22, 58, <a href="#">R35</a>
🕒 button	13, <a href="#">R34</a>
🔄 (Preview)	61
📷 (Metering Mode)	45
📷 (Metering Mode)	45
📷 (Metering Mode)	45
📷 (AF point)	44
📷 (AF point)	44
📷 menu	<a href="#">R4</a> , <a href="#">R13</a>
📷 menu	<a href="#">R6</a> , <a href="#">R22</a>
📷 menu	<a href="#">R7</a> , <a href="#">R23</a>
<b>C</b> menu	<a href="#">R9</a> , <a href="#">R30</a>
<b>A</b>	
AC adapter	30
Accessories	10, 26, 90
AdobeRGB	<a href="#">R19</a>
AE lock	49, <a href="#">R30</a>
<b>AE-L</b> button	49
<b>AF</b> button	44, <a href="#">R31</a>
AF Fine Adjustment	<a href="#">R35</a>
AF point	44, <a href="#">R30</a>
AF with Remote Control	<a href="#">R32</a>

<b>A.F.C</b>	44
<b>A.F.S</b>	44
Aperture Priority mode	47
Auto (White Balance)	50
Auto Bracketing	56
Auto Bracketing Order	<a href="#">R31</a>
Auto EV Compensation	<a href="#">R31</a>
AUTO ISO Parameters	<a href="#">R14</a>
Auto Power Off	<a href="#">R27</a>
Auto Rotation	<a href="#">R18</a> , <a href="#">R35</a>
<b>AWB</b> (White Balance)	50
AV equipment	79
<b>Av</b> mode	47, <a href="#">R34</a>

## B

<b>B</b> mode	47, <a href="#">R34</a>
Base Parameter Adj (Digital Filter)	76
Battery	28
Battery level	29
Beep	<a href="#">R24</a>
Best (Quality level)	43, <a href="#">R14</a>
Better (Quality level)	43, <a href="#">R14</a>
Bright/Dark Area	<a href="#">R22</a>
Brightness Level	<a href="#">R24</a>
Bulb mode	47

## C

<b>C</b> (AF mode)	44
Cable switch terminal	11
Calendar display	69

Card access lamp	11
CCD plane indicator	11
Center-weighted metering	45
Charging	28
City	<a href="#">R23</a>
Cloudy (White Balance)	50
Color (Digital Filter)	76
Color Space	<a href="#">R19</a>
Color Temperature	52
Color Temperature Steps	<a href="#">R33</a>
Compression ratio	<a href="#">R14</a>
Connecting to a computer	82
Continuous mode	44
Continuous Shooting	53
Contrast (Custom Image)	62
Contrast (Extended Bracketing)	<a href="#">R16</a>
Control panel	16, 39
Copyright Holder	<a href="#">R27</a>
Copyright Information	<a href="#">R27</a>
Cropping	75
<b>CTE</b> (White Balance)	50
Custom Image	62
Custom setting menu	<a href="#">R9</a> , <a href="#">R30</a>

## D

Data Saving Method	42, <a href="#">R13</a>
Date Adjustment	35, <a href="#">R23</a>
Date imprint	78
Daylight (White Balance)	50
Default Settings	<a href="#">R4</a>
Delete all images	<a href="#">R22</a>

Delete an single image .....	67	Exposure lock timer.....	46, <a href="#">R30</a>	Focus Mode.....	44
Destination.....	<a href="#">R23</a>	Exposure Mode .....	47, <a href="#">R13</a>	Folder display .....	69
Detailed information display.....	18	Exposure warning .....	21	Folder Name.....	<a href="#">R26</a>
Development.....	72	Extended Bracketing .....	57, <a href="#">R16</a>	Format .....	36, <a href="#">R29</a>
Digital Camera Utility .....	82	External flash .....	<a href="#">R35</a>	Function settings .....	38
Digital Filter.....	76	Extract Color (Digital Filter) .....	76		
Digital Preview .....	61, <a href="#">R18</a>	Eyecup .....	37		
Dioptr adjustment.....	37			<b>G</b>	
Direct keys .....	38, <a href="#">R11</a>			Good (Quality level).....	43, <a href="#">R14</a>
<b>DISP</b> button .....	15, 66	<b>F</b>		Green button.....	<a href="#">R34</a>
Display Color .....	<a href="#">R18</a>	File Format.....	42, <a href="#">R13</a>	Guide Display .....	14, <a href="#">R24</a>
Display Language .....	34, <a href="#">R23</a>	File Name.....	<a href="#">R26</a>		
Distortion.....	<a href="#">R15</a>	Filter (Digital Filter).....	76	<b>H</b>	
DNG.....	<a href="#">R19</a>	Filter Effect (Custom Image) .....	62	HDMI cable.....	79
DPOF.....	78	Fine Sharpness (Custom Image) .....	62	HDMI Out.....	<a href="#">R25</a>
D-Range Setting .....	<a href="#">R14</a>	Flash .....	60	HDR Capture .....	<a href="#">R16</a>
<b>DRIVE</b> button .....	53	Flash (White Balance).....	50	Help .....	87
Drive Mode .....	53	<b>⚡</b> button .....	59	High definition.....	79
Dust Alert.....	<a href="#">R28</a>	Flash compatibility.....	60	High dynamic range capture.....	<a href="#">R16</a>
Dust Removal .....	<a href="#">R29</a>	Flash compensation .....	59	High/Low Key Adjustment (Custom Image).....	62
Dynamic Range .....	<a href="#">R14</a>	Flash Mode .....	58	High/Low Key Adjustment (Extended Bracketing).....	<a href="#">R16</a>
		Flash On.....	58	High-ISO Noise Reduction .....	<a href="#">R32</a>
<b>E</b>		Flash X-sync Speed mode .....	47	Highlight Correction .....	<a href="#">R14</a>
e-dial.....	<a href="#">R33</a>	Florescent Light (White Balance) ...	50	Histogram display .....	19
Electronic Level Display.....	17, 21, <a href="#">R19</a>	Florescent Light Cool White (White Balance).....	50	Hometown .....	34, <a href="#">R23</a>
Error message .....	93	Florescent Light Daylight Color (White Balance).....	50	Hue (Custom Image) .....	62
EV bar.....	20	Florescent Light Daylight White (White Balance).....	50	Hue (Extended Bracketing) .....	<a href="#">R16</a>
EV Compensation.....	48	Florescent Light Warm White (White Balance).....	50	Hyper-manual mode .....	47
EV Steps.....	<a href="#">R30</a>			Hyper-program mode .....	47
Expanded Sensitivity .....	<a href="#">R30</a>				
Exposure Bracketing.....	56				

<b>I</b>	
Image Comparison .....	70
Image plane indicator .....	11
Image Rotation .....	74
Image Tone.....	62
Index.....	71
Index display.....	68
<b>INFO</b> button.....	16, 17
Initial Setting .....	34
Initialize.....	R29
Installing software.....	84
Instant Review .....	37, R18
Interval .....	R22
Interval Shooting.....	54, R17
ISO AUTO Adjustment.....	R14
<b>ISO</b> button .....	46
<b>J</b>	
JPEG .....	42
JPEG Quality .....	R14
JPEG Recorded Pixels .....	R13
<b>K</b>	
Kelvin .....	52, R33
<b>L</b>	
Language/言語 .....	34, R23
Language setting .....	34, R23
Lateral chromatic aberration .....	R15
LCD Color Tuning.....	R25
LCD panel.....	22
Lens.....	24

Lens compatibility.....	26
Lens Correction.....	R15
Locking exposure value .....	49

## M

<b>M</b> mode.....	47, R34
<b>MUP</b> dial .....	55
Macintosh.....	82
Manual mode .....	47
Manual White Balance .....	51
Memory .....	R20
Menu .....	40, R4
Menu operation .....	R12
Metering mode .....	45
Mired .....	52, R33
Mirror Up .....	55
Mode dial.....	48
Modeling Flash.....	R35
Monitor .....	14
Monochrome (Digital Filter).....	76
MSC .....	R25
Multi-exposure.....	55, R17
Multi-image display .....	68
Multi-segment metering.....	45

## N

Names of parts.....	11
Noise Reduction.....	R32
NTSC .....	R25
Number of AF Points.....	R32
Number of shots.....	R36

## O

One-Push Bracketing .....	R30
Optical Preview.....	61, R18

## P

<b>P</b> mode.....	47, R33
PAL.....	R25
PEF.....	R19
Photographer.....	R27
Pixel Mapping .....	R28
Pixels .....	43, R13, R35
Playback .....	38, 66
Playback Display Method .....	R22
Playback Menu .....	R6, R22
Playback Mode Palette.....	66, R11
Power .....	33
Press halfway .....	R32
Preview.....	61, R18
Print Setting.....	78
Product registration .....	87
Program Line .....	47, R15
Program mode.....	47
Protect .....	73
Provided software.....	84
PTP.....	R25

## Q

Quality Level.....	43, R14
--------------------	---------

## R

RAW .....	42
<b>RAW</b> button .....	R19

RAW Development .....	72
RAW File Format .....	R19
Rec. Mode menu .....	R4, R13
Recorded Pixels .....	43, R13, R35
Red-eye reduction .....	58
Remote Control .....	54
Remote Control in <b>B</b> .....	R32
Repeat Playback .....	R22
RESERVE .....	42
Reset .....	R28, R35
Resize .....	75
Rotate .....	74
Rotation information .....	R35
<b>S</b>	
Saturation (Custom Image) .....	62
Saturation (Extended Bracketing) .....	R16
Save as Manual WB .....	52
Save Setting (White Balance) .....	52
Screen Effect .....	R22
SD Memory Card .....	31, 36
<b>SD1/SD2</b> button .....	42
SD1/SD2 Image File Format .....	R13
<b>SEL</b> .....	44
Select & Delete .....	68
Self-timer .....	54
Sensitivity .....	46, R14
Sensitivity Priority mode .....	47
Sensitivity Start Level .....	R32
Sensitivity steps .....	R30

Sensor Cleaning .....	R29
Setting the Time .....	R23
Set-up menu .....	R7, R23
Shade (White Balance) .....	50
Shadow Correction .....	R14
Sharpness (Extended Bracketing) .....	R16
Sharpness (Custom Image) .....	62
Shooting .....	37
Shooting information .....	14
Shutter & Aperture Priority mode ....	47
Shutter Priority mode .....	47
Single Image Display .....	67
Single mode .....	44
Slideshow .....	70, R22
Slot .....	42
Slow Shutter Speed NR .....	R32
Slow-speed Sync .....	58
Soft (Digital Filter) .....	76
Specifications .....	R36
Spot metering .....	45
sRGB .....	R19
Start Interval .....	R17
Status Screen .....	15, R18
Strap .....	24
Superimpose AF Area .....	44, R32
<b>Sv</b> mode .....	47, R33
Sync cord .....	58
System requirements .....	82

**T**

<b>TAv</b> mode .....	47, R34
Test Flash .....	R35
Text Size .....	34, R24
TIFF .....	72
Toning (Custom Image) .....	62
Tungsten Light .....	R31
Tungsten Light (White Balance) .....	50
<b>Tv</b> mode .....	47, R33

**U**

USB Connection .....	83, R25
USB terminal .....	83
<b>USER</b> .....	R20
<b>USER</b> mode .....	47
User setting mode .....	47, R20

**V**

Vertical position .....	16
Video cable .....	79
Video Out .....	R25
Video terminal .....	79
Viewfinder .....	20
Viewing a captured image .....	37

**W**

WARRANTY POLICY .....	100, R45
WB Adjustable Range .....	R31
<b>WB</b> button .....	50
WB When Using Flash .....	R31
White Balance .....	50

White Balance (Extended Bracketing)	
.....	R16
Windows .....	82
World Time .....	R23
<b>X</b>	
<b>X</b> mode.....	47, R34
X-sync socket .....	58
<b>Z</b>	
Zoom display .....	67

# WARRANTY POLICY

All PENTAX cameras purchased through authorized bona fide photographic distribution channels are guaranteed against defects of material or workmanship for a period of twelve months from date of purchase. Service will be rendered, and defective parts will be replaced without cost to you within that period, provided the equipment does not show evidence of impact, sand or liquid damage, mishandling, tampering, battery or chemical corrosion, operation contrary to operating instructions, or modification by an unauthorized repair shop. The manufacturer or its authorized representatives shall not be liable for any repair or alterations except those made with its written consent and shall not be liable for damages from delay or loss of use or from other indirect or consequential damages of any kind, whether caused by defective material or workmanship or otherwise; and it is expressly agreed that the liability of the manufacturer or its representatives under all guarantees or warranties, whether expressed or implied, is strictly limited to the replacement of parts as hereinbefore provided. No refunds will be made on repairs by non-authorized PENTAX service facilities.

## Procedure During 12-month Warranty Period

Any PENTAX which proves defective during the 12-month warranty period should be returned to the dealer from whom you purchased the equipment or to the manufacturer. If there is no representative of the manufacturer in your country, send the equipment to the manufacturer, with postage prepaid. In this case, it will take a considerable length of time before the equipment can be returned to you owing to the complicated customs procedures required. If the equipment is covered by warranty, repairs will be made and parts replaced free of charge, and the equipment will be returned to you upon completion of servicing. If the equipment is not covered by warranty, regular charges of the manufacturer or of its representatives will apply. Shipping charges are to be borne by the owner. If your PENTAX was purchased outside of the country where you wish to have it serviced during the warranty period, regular handling and servicing fees may be charged by the manufacturer's representatives in that country. Notwithstanding this, your PENTAX returned to the manufacturer will be serviced free of

charge according to this procedure and warranty policy. In any case, however, shipping charges and customs clearance fees to be borne by the sender. To prove the date of your purchase when required, please keep the receipt or bills covering the purchase of your equipment for at least a year. Before sending your equipment for servicing, please make sure that you are sending it to the manufacturer's authorized representatives or their approved repair shops, unless you are sending it directly to the manufacturer. Always obtain a quotation for the service charge, and only after you accept the quoted service charge, instruct the service station to proceed with the servicing.

- **This warranty policy does not affect the customer's statutory rights.**
- **The local warranty policies available from PENTAX distributors in some countries can supersede this warranty policy. Therefore, we recommend that you review the warranty card supplied with your product at the time of purchase, or contact the PENTAX distributor in your country for more information and to receive a copy of the warranty policy.**



The CE Mark is a Directive conformity mark of the European Union.

## For customers in USA

### STATEMENT OF FCC COMPLIANCE

This device complies with Part 15 of the FCC Rules. Operation is subject to the following two conditions: (1) This device may not cause harmful interference, and (2) this device must accept any interference received, including interference that may cause undesired operation.

Changes or modifications not approved by the party responsible for compliance could void the user's authority to operate the equipment.

This equipment has been tested and found to comply with the limits for a Class B digital device, pursuant to part 15 of the FCC Rules.

These limits are designed to provide reasonable protection against harmful interference in a residential installation. This equipment generates, uses and can radiate radio frequency energy and, if not installed and used in accordance with the instructions, may cause harmful interference to radio communications. However, there is no guarantee that interference will not occur in a particular installation.

If this equipment does cause harmful interference to radio or television reception, which can be determined by turning the equipment off and on, the user is encouraged to try to correct the interference by one or more of the following measures:

- Reorient or relocate the receiving antenna.  
Increase the separation between the equipment and receiver.  
Connect the equipment into an outlet on a circuit different from that to which the receiver is connected.
- \* Consult the dealer or an experienced radio/TV technician for help.

## For customers in Canada

This Class B digital apparatus complies with Canadian ICES-003.

### Pour les utilisateurs au Canada

Cet appareil numérique de la classe B est conforme à la norme NMB-003 du Canada.

### FOR CALIFORNIA, U.S.A. ONLY

Perchlorate Material-special handling may apply. The lithium battery used in this camera contains perchlorate material, which may require special handling. See [www.dtsc.ca.gov/hazardouswaste/perchlorate](http://www.dtsc.ca.gov/hazardouswaste/perchlorate)

## Declaration of Conformity

### According to 47CFR, Parts 2 and 15 for Class B Personal Computers and Peripherals

We: PENTAX RICOH IMAGING AMERICAS  
CORPORATION

Located at: 633 17<sup>th</sup> Street, Suite 2600  
Denver, Colorado 80202 U.S.A.  
Phone: 800-877-0155  
FAX: 303-790-1131

Declare under sole responsibility that the product identified herein complies with 47CFR Parts 2 and 15 of the FCC rules as a Class B digital device. Each product marketed is identical to the representative unit tested and found to be compliant with the standards. Records maintained continue to reflect the equipment being produced can be expected to be within the variation accepted, due to quantity production and testing on the statistical basis as required by 47CFR §2.909. Operation is subject to the following two conditions: (1) This device may not cause harmful interference, and (2) This device must accept any interference received, including interference that may cause undesired operation. The above named party is responsible for ensuring that the equipment complies with the standards of 47CFR §15.101 to §15.109.

Product Name: Lens-interchangeable medium-  
format digital SLR (Single Lens  
Reflex) Camera

Model Number: 645D

Contact person: Customer Service Manager

Date and Place: October, 2011, Colorado



## Information for Users on Collection and Disposal of Old Equipment and Used Batteries



### 1. In the European Union

These symbols on the products, packaging and/or accompanying documents mean that used electrical and electronic equipment and batteries should not be mixed with general household waste.

Used electrical/electronic equipment and batteries must be treated separately and in accordance with legislation that requires proper treatment, recovery and recycling of these products.



By disposing of these products correctly you will help ensure that the waste undergoes the necessary treatment, recovery and recycling and thus prevent potential negative effects on the environment and human health which could otherwise arise due to inappropriate waste handling.

If a chemical symbol is added beneath the symbol shown above, in accordance with the Battery Directive, this indicates that a heavy metal (Hg = Mercury, Cd = Cadmium, Pb = Lead) is present in the battery at a concentration above an applicable threshold specified in the Battery Directive.

For more information about collection and recycling of used products, please contact your local authorities, your waste disposal service or the point of sale where you purchased the products.

### 2. In other countries outside the EU

These symbols are only valid in the European Union. If you wish to discard used products, please contact your local authorities or dealer and ask for the correct method of disposal.

For Switzerland: Used electrical/electronic equipment can be returned free of charge to the dealer, even when you don't purchase a new product. Further collection facilities are listed on the home page of [www.swico.ch](http://www.swico.ch) or [www.sens.ch](http://www.sens.ch).

# MEMO

# MEMO

**PENTAX RICOH IMAGING CO, LTD.** 2-35-7, Maeno-cho, Itabashi-ku, Tokyo 174-8639, JAPAN  
(<http://www.pentax.jp>)

**PENTAX RICOH IMAGING FRANCE S.A.S.  
(European Headquarters)** 112 Quai de Bezons, B.P. 204, 95106 Argenteuil Cedex, FRANCE  
(HQ - <http://www.pentax.eu>)  
(France - <http://www.pentax.fr>)

**PENTAX RICOH IMAGING DEUTSCHLAND  
GmbH** Julius-Vosseler-Strasse 104, 22527 Hamburg, GERMANY  
(<http://www.pentax.de>)

**PENTAX RICOH IMAGING UK LTD.** PENTAX House, Heron Drive, Langley, Slough, Berks SL3 8PN, U.K.  
(<http://www.pentax.co.uk>)

**PENTAX RICOH IMAGING AMERICAS  
CORPORATION** 633 17th Street, Suite 2600, Denver, Colorado 80202, U.S.A.  
(<http://www.pentaximaging.com>)

**PENTAX RICOH IMAGING CANADA INC.** 1770 Argentia Road Mississauga, Ontario L5N 3S7, CANADA  
(<http://www.pentax.ca>)

**<http://www.pentax.jp/english>**

- Specifications and external dimensions are subject to change without notice.

## Free Manuals Download Website

<http://myh66.com>

<http://usermanuals.us>

<http://www.somanuals.com>

<http://www.4manuals.cc>

<http://www.manual-lib.com>

<http://www.404manual.com>

<http://www.luxmanual.com>

<http://aubethermostatmanual.com>

Golf course search by state

<http://golfingnear.com>

Email search by domain

<http://emailbydomain.com>

Auto manuals search

<http://auto.somanuals.com>

TV manuals search

<http://tv.somanuals.com>