

PENTAX™

MZ-60 QUARTZ DATE

OPERATING MANUAL

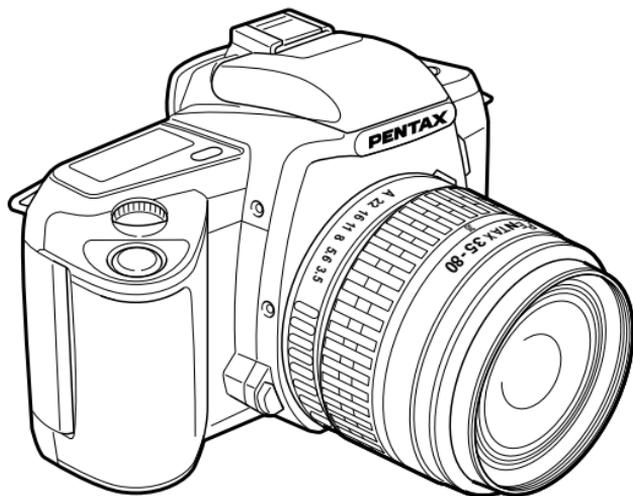

ABCDE FGHIJKL MNOP QRSTUV
BASIC OPERATION
(PREPARATION)

ABCDE FGHIJKL MNOP QRSTUV
BASIC OPERATION
(SHOOTING)

ABCDE FGHIJKL MNOP QRSTUV
ADVANCED OPERATIONS

OTHERS

Congratulations on your purchase of this camera and welcome to the exciting world of Pentax autofocus photography! This compact and lightweight camera is an autofocus SLR camera that offers higher levels of sophistication and performance. Incorporating a broad range of advanced technologies and highly accurate automation, this camera will perform superbly for the most exacting photographer.

- Read this instruction manual carefully to get a full explanation of operations before use.
- Illustrations in this operating manual are the data function.

The camera does not operate when a lens with the following conditions attached.

1. When a lens that does not have the A position on the aperture ring is attached.
2. When an F, FA or A lens is attached with the aperture ring set other than the A position.
3. When any accessory mentioned on page 74 is used between the camera and an F, FA or A lens.

Lenses and accessories produced by other manufacturers are not made to our precise specifications and therefore may cause difficulties with, or actual damage to, your Pentax camera. We do not assume any responsibility or liability for difficulties resulting from the use of lenses and accessories made by other manufacturers.

FOR SAFE USE OF YOUR CAMERA

Although we have carefully designed this camera for safe operation, please be sure to follow precautions given on this page.



WARNING: This mark indicates precautions that, if not followed, could result in serious injury to the person.



CAUTION: This mark indicates precautions that, if not followed, could result in minor or medium injury to the person or damage to the equipment.



WARNING

- The electronic circuits inside the camera contain high voltage working parts. Never attempt to disassemble the camera yourself.
- Never touch internal parts of the camera if they become exposed from dropping the camera or for some other reason, as there is danger of an electric shock.
- Wrapping the strap around your neck is dangerous. Make sure that small children do not get the strap caught around their neck.
- Do not look directly at the sun through the camera, as viewing the sun may damage your eyes, and/or parts of the camera (e.g.: shutter curtains, etc.)
- Be sure to store batteries out of the reach of children. Seek medical assistance immediately if accidentally swallowed.



CAUTION

- Do not use the flash near anyone's eyes, as it may hurt them. Be particularly careful with the flash around infants.
 - Never try to disassemble, short or recharge the battery. Also, do not dispose of the battery in fire, as it may explode.
 - Remove the batteries from the camera immediately if they become hot or begin to smoke. Be careful not to burn yourself during removal.
- Download from [Www.Somanuals.com](http://www.Somanuals.com). All Manuals Search And Download.

PRECAUTIONS FOR YOUR CAMERA

Your Pentax camera is a high-precision mechanism. Handle it with great care.

Precautions when taking pictures

- Do not use the camera where it may come in contact with rain, water, or any other liquid, because the camera is not weather, water, or liquid resistant. Should the camera get wet from rain, splashing water, or any other liquid wipe it off immediately with a dry soft cloth.
- Do not drop the camera or allow it to hit solid objects. If the camera suffers a shock or impact, take it to a Pentax service center for inspection.
- Be careful not to subject the camera to strong vibrations, shock or pressure. Use a cushion to protect the camera when carrying it in a motorcycle, car, boat, etc.
- Condensation on the interior or exterior of the camera may be extremely harmful to the camera mechanism as it may cause rust. Furthermore, if the camera is taken from warm temperature to a subfreezing one or vice versa, the formation of icelets may cause damage. In such a case, put the camera into a case or plastic bag so that any changes in temperature difference is minimized. Do not remove it from the bag until temperature has stabilized.
- Regular size color prints may cut off what appears on the extreme edges of the film frame. Compose your picture with a margin of safety at the edges.

Precautions for storage

- Avoid leaving the camera for extended periods in places where the humidity and temperature are very high, such as in a car.
- Do not store the camera in a closet with moth balls or in an area where chemicals are handled. Store it in a place with good dry air circulation to prevent the growth of fungus.

Precautions for proper care

- Never touch the shutter curtain or mirror with your finger or any other object.
- Use a blower and lens brush to remove dust accumulated on the lens or viewfinder.
- Never use solvents such as paint thinner, alcohol or benzene to clean the camera.
- Electrical problems may often be caused by water, dirt or dust at points of electrical contact. Also check for battery leakage, traces of dirt or grease, or corrosion due to salinity or gas. If you cannot correct the problems, have your camera inspected at a Pentax service center. Repairs of this nature are not

Other precautions

- The temperature range at which this camera functions properly is 50°C to -10°C (122F° to 14F°).
- A camera which has been submerged in water usually cannot be repaired. If such an accident should occur, it is advisable to contact a Pentax Service Center immediately.
- To maintain optimum performance, it is recommended that the camera be inspected every one or two years. If the camera has not been used for an extended period, or is being prepared for an important photographic session, it is recommended that you have the camera inspected or test shoot with it.
- Repairs deemed necessary due to usage of this product in an industrial or commercial application may not be covered under the terms of the Pentax warranty.
- The PENTAX warranty provides only for the repair of defects in materials or workmanship. Damage of any kind cannot be repaired at any charge under the terms of the warranty. If the difficulty is caused as a direct result of the product being used in conditions as outlined in the "Precautions for Your Camera" section or any other operation contrary to the instructions outlined in this manual, charges will be assessed and a repair quotation will be provided.

PRECAUTIONS FOR BATTERY USAGE

- Use two 3V lithium batteries (CR2 type).
- Misuse of the battery can cause hazards such as leakage, overheating, explosion, etc. The battery should be inserted correctly with regard to polarity (+ and -) marked on the battery and the camera.
- Battery performance may be temporarily hindered in low temperatures, but will recover in normal temperatures.
- Keep a spare battery on hand for replacement convenience when shooting outdoors or while traveling.
- If the built-in flash is used continuously, the battery may become warm, but it does not mean that the battery is faulty; it is one of the battery's characteristics.
- Replace the batteries at the same time. Do not mix battery brands, type or an old battery with a new one. It may cause explosion or overheating.

TABLE OF CONTENTS

FOR SAFE USE OF YOUR CAMERA	1
PRECAUTIONS FOR YOUR CAMERA	2
PRECAUTIONS FOR BATTERY USAGE	3
TABLE OF CONTENTS	4
NAMES OF WORKING PARTS	6
LCD PANEL INDICATIONS	8
VIEWFINDER INDICATIONS	10
QUICK AND EASY SHOOTING	11
CAMERA FUNCTIONS AVAILABLE WITH VARIOUS LENSES ..	12
HOW TO USE THIS OPERATION MANUAL	14

1

BASIC OPERATION (PREPARATION)

17

STEP1. ATTACHING THE CAMERA STRAP	18
STEP2. LOADING THE BATTERIES	19
• BATTERY LIFE	21
• IF THE BATTERY IS EXHAUSTED	22
STEP3. TURNING ON THE POWER	23
STEP4. SETTING THE DATA	24
STEP5. ADJUSTING DATE AND TIME	26
STEP6. ATTACHING THE LENS	28
STEP7. FILM LOADING	30
STEP8. OPERATING THE SHUTTER RELEASE BUTTON ..	32

2

BASIC OPERATION (SHOOTING)

33

Step 1. SET THE STANDARD PROGRAM MODE . . .	34
Step 2. SET THE AUTO POP-UP FLASH	35
Step 3. SET THE SINGLE FRAME DRIVE MODE . . .	36
Step 4. SET THE AUTO FOCUS MODE TO AF	37
Step 5. USING THE ZOOM LENS	38
Step 6. HOLDING THE CAMERA	39
Step 7. TAKING A PICTURE	40
Step 8. UNLOADING A FILM	42
Step 9. REWINDING A FILM IN MID-ROLL	43

3

ADVANCED OPERATIONS

XX

SELECTING A DRIVE MODE	45-50
CONSECUTIVE-FRAME DRIVE MODE	46
SELF-TIMER MODE	47
AUTO BRACKET EXPOSURE MODE	49
SELECTING 6 PICTURE MODES	51-58
STANDARD PROGRAM MODE 	53
PORTRAIT PROGRAM MODE 	54
LANDSCAPE PROGRAM MODE 	55
ACTION PROGRAM MODE 	56
CLOSE-UP PROGRAM MODE 	57
NIGHT-SCENE PROGRAM MODE 	5859
EFFECT OF APERTURE AND SHUTTER SPEED . . .	61

TABLE OF CONTENTS

SELECTING ANOTHER EXPOSURE MODES	61-69
APERTURE- PRIORITY AE MODE	61
SHUTTER- PRIORITY AE MODE	63
METERED MANUAL MODE	65
AE LOCK FNCTION	70
MANUAL FOCUSING	71
HARD-TO-AUTOFOFUS SUBJECTS	73
SETTING THE FILM SPEED (ISO) MANUALLY	87
USING BUILT-IN FLASH	74
SELECTING THE VARIOUS BUILT-IN FLASH MODES	
RED-EYE REDUCTION FLASH FUNCTION	76
ABOUT RED-EYE PHENOMENON	76
FLASH EFFECTIVE RANGE FOR THE PICTURE	
MODE WITH ISO 100 (400) FILM USED	77
MANUAL POP UP THE BUILT-IN FLASH	78
FLASH OFF MODE	80
DAYLIGHT-SYNC SHOOTING	81
ADVANCED OPERATION FOR BUILT-IN FLASH . . .	82
COMPATIBILITY OF F AND FA LENSES WITH	
THE BUILT-IN FLASH	85
OVERVIEW OF FLASH FUNCTION	88
USING PENTAX DEDICATED AUTO FLASH	90
SLOW-SPED=SYNC SHOOTING	94

4

OTHERS

XX

ACCESSORIES (OPTIONAL)XX
TROUBLESHOOTINGXX
PROGRAM LINESXX
STANDARD PROGRAM MODE	
NIGHT-SCENE PROGRAM MODE WITHOUT FLASH	
PORTRAIT PROGRAM MODE	
LANDSCAPE PROGRAM MODE	
CLOSE-UP PROGRAM MODE	
ACTION PROGRAM MODE	
SPECIFICATIONSXX
WARRANTY POLICYXX

NAMES OF WORKING PARTS

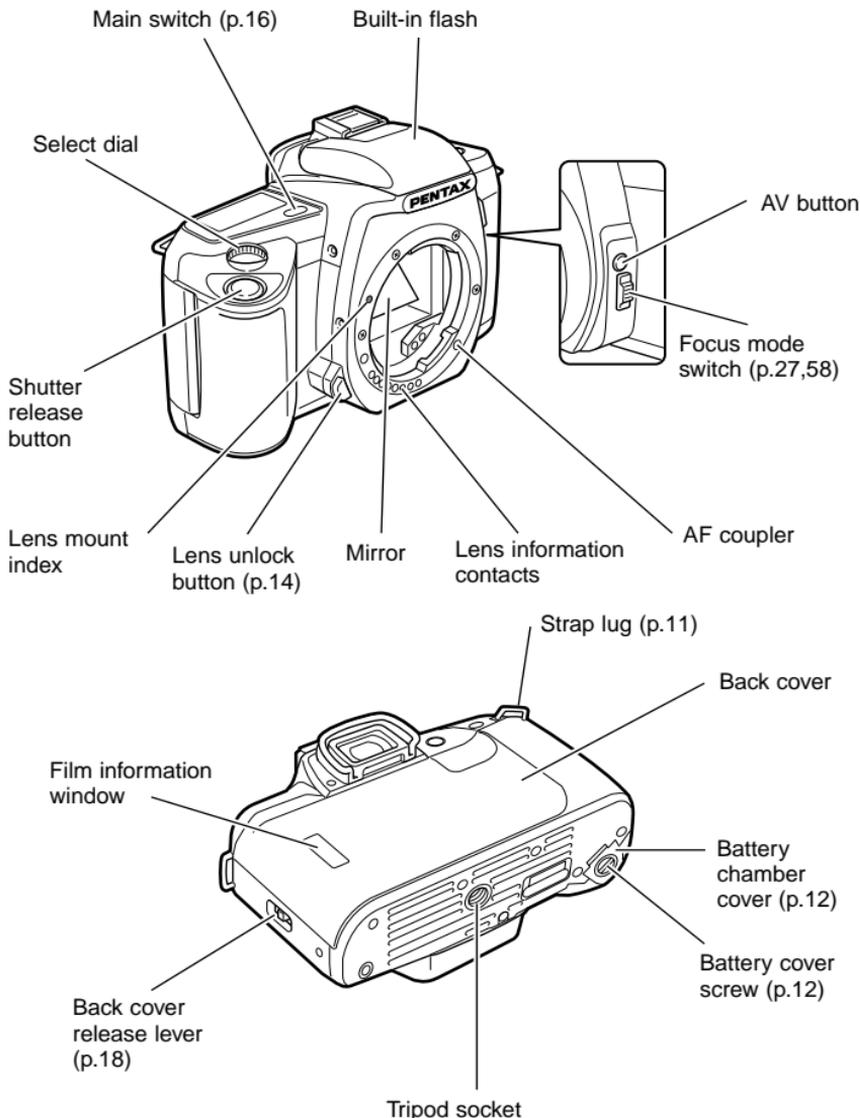

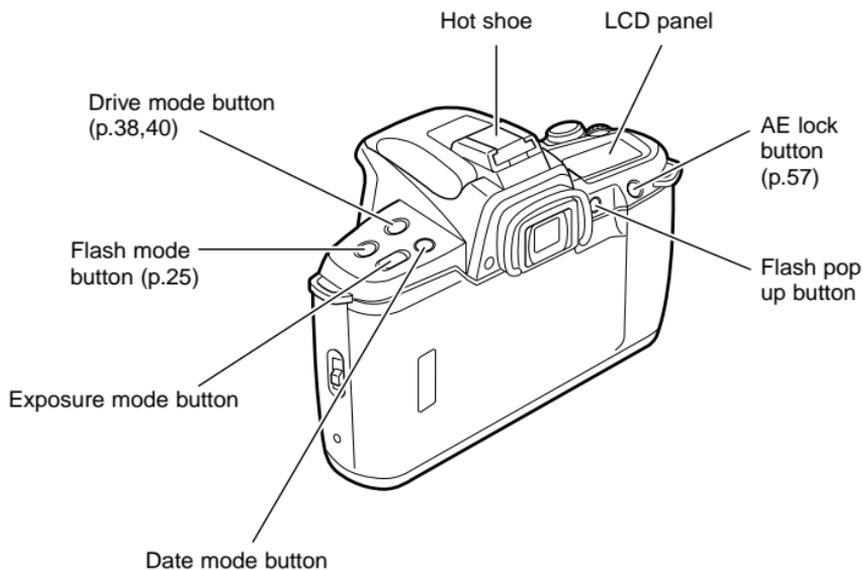

??

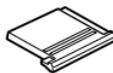
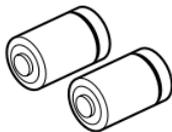

• ??????

• ??????

LCD PANEL INDICATION

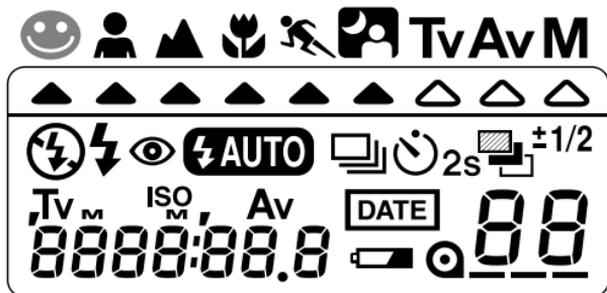

- | | | | |
|----------------|---|--|--|
| | : Flash status information
(p. 25, 36) | | : Date mode |
| | : Flash off information
(p. 26) | | : Exposure mode/
AV,TV select pointer |
| | : Red-eye reduction flash
indication (p. 32) | | : Self-timer
(p.38) |
| | : Automatic flash
information (p. 25) | | : 2 seconds self-timer |
| ISO | : Manual-set film speed
(p. 64) | | : Aperture value |
| Tv 8888 | : Shutter speed | | : Auto bracket exposure
(p.55) |
| | : Battery exhaustion
warning (p.13) | | : Film status information
(p.20,21) |
| | : Consecutive shooting
(p.38) | | : Exposure counter |
| | | | : Day/time |

All indications will not actually appear simultaneously as shown.

LCD (Liquid-Crystal Display)

When the LCD is exposed to high temperatures over approximately 60!, it may blacken, but when the temperature normalizes, it should return to normal.

VIEWFINDER INDICATION

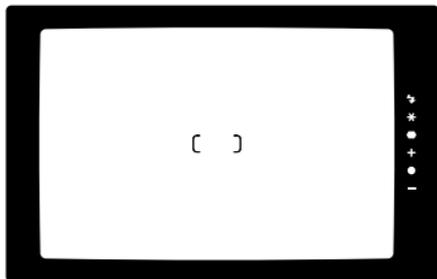

- [] : AF frame (p. 30)
- ⚡ : Flash status information (p. 32, 36)
- * : AE lock (p. 57)
- : Focus indicator (p. 59)
- +
- : Correct exposure
- : Under exposure

QUICK AND EASY SHOOTING

- 1 Loading the batteries**
Open the battery cover and load two CR2 Lithium batteries.
See page xx

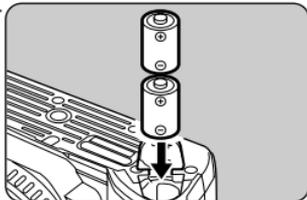

- 2 Set the date and time**
You can skip this step if you do not imprint the data at this time. The date and time should be adjusted after loading the batteries. **See page xx**

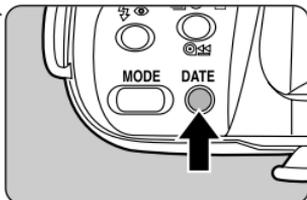

- 3 Attaching the lens**
Align the red dots on the camera and lens mounts. Turn the lens to clockwise until it clicks in place.
See page xx

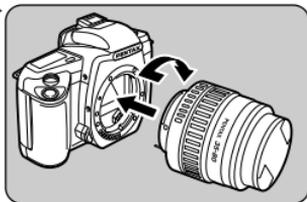

- 4 Set the lens aperture ring to **A** position**
This camera does not work other than **A** position. **See page xx**

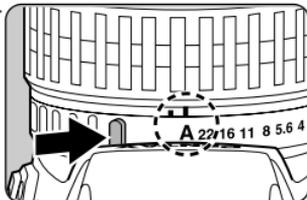

- 5 Turn the power switch ON.**
Depress the main switch button.
See page xx

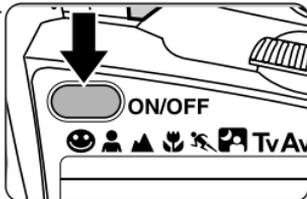

6 Set the exposure mode to Standard program mode.

Move the select lever to set the pointer  to  while depressing the exposure mode button. See page xx

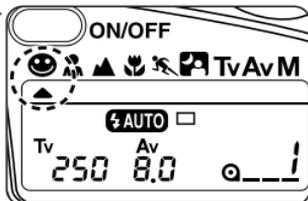

7 Loading the film.

See page xx

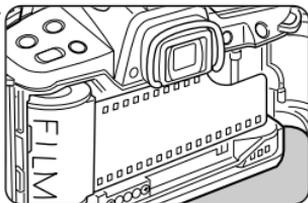

8 Set to the Autofocus

Set the focus mode switch to  in down position. See page xx

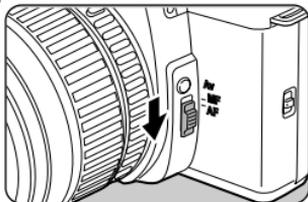

9 Compose the subject by turning the zoom ring.

See page xx



10 Adjust the focus and take a picture.

Frame the subject in the focus frame  and depress the shutter release button. Auto flash pops up automatically if it necessary. See page xx



CAMERA FUNCTIONS AVAILABLE WITH VARIOUS LENSES

Function	Lens [Mount type]	FA lens [KAF2] *1	F lens [KAF] *1
Autofocus (Lens only)		○	○
Manual focus (with FI) *2 (with Matte field)		○*3 ○	○*3 ○
Power zoom		×	×
Image size tracking		×	×
Zoom clip		×	×
Auto zoom effect		×	×
Picture Mode		○	○
Aperture-Priority AE		○	○
Shutter-Priority AE		○	○
Metered Manual		○	○
Auto-popup built-in flash mode *4		○	○
Programmed TTL Auto Flash		○	○
TTL Auto Flash		○	○
????????????????		○	○

Notes:

- *1. As an F/FA 85mm f/2.8 Soft lenses and FA 28mm f/2.8 soft lens do not have the  position on the aperture ring, the shutter cannot be released.
- *2. Manual focusing using the focus indicator (FI) in the viewfinder.
- *3. Lenses with a maximum aperture of f/5.6 or larger.
- *4. Only works when the picture mode is selected.

 **MEMO**

- KAF2 and KAF mount lenses are designed to work with the Autofocus SLR camera.
- The A, F, and FA lenses have the  (auto) position on the lens aperture ring.

The camera will not operate when a lens with following condition.

1. When a lens, which does not have the  position on the aperture ring is attached.
2. When an F, FA or A lens is attached with aperture ring set other than the  position.
3. The accessories for close-up photography are attached.

HOW TO USE THIS OPERATING MANUAL

This manual is organized into the following sections.

1**Basic Operation (Preparation)**

→Page xx

2**Basic Operation (Shooting)**

→Page xx

3**Advanced Operations**

→Page xx

4**Other information**

→Page xx

If you like to begin taking pictures with this new camera as soon as possible, read section 1 and 2, "BASIC OPERATION(PREPARATION)" and " BASIC OPERATION (SHOOTING)". These sections introduce only the basic functions of this camera.

More detailed information can be found in the section 3 and the section 4.

1

BASIC OPERATION (PREPARATION)

- Step 1** PATTACHING THE CAMERA STRAP18
- Step 2** LOADING THE BATTERIES19
- Step 3** TURNING ON THE POWER18
- Step 4** SETTING THE DATA BACK18
- Step 5** IMPRINTING THE DATA18
- Step 6** ATTACHING THE LENS18
- Step 7** FILM LOADING18
- Step 8** OPRATING THE SHUTTER RELEASE
BUTTON18

ATTACHING THE CAMERA STRAP

- 1 Pass the end of the strap through the strap lug from underneath, and then pass the strap through the clasp from underneath as illustrated.

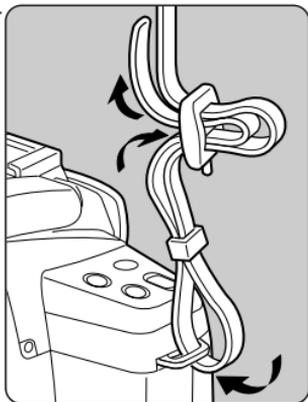

- 2 Follow the same procedure to attach the other end of the strap to the other strap lug.

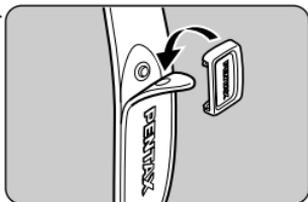

MEMO

- The strap has pockets that can store the viewfinder cap, hot shoe cover or any other small accessory as illustrated.

LOADING THE BATTERIES

- 1** Open the battery chamber cover by turning it to counterclockwise with a coin, etc. as shown in the illustration.

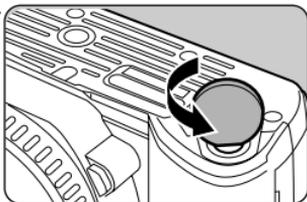

- 2** Load two 3V lithium batteries (CR2) or equivalent into the battery chamber with positive (+) contacts of the batteries pointing up as shown in the illustration.

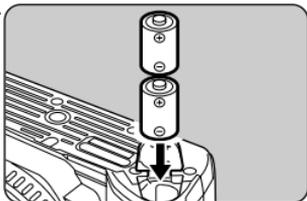

- 3** Push in the battery chamber cover firmly and use a coin to turn the cover clockwise to lock securely.

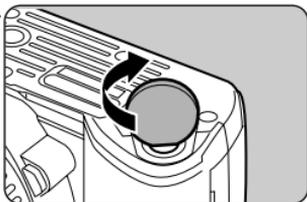

- 4** If the batteries are removed, date indicates [-----] that no data will be imprinted. See page xx for setting the date and time.

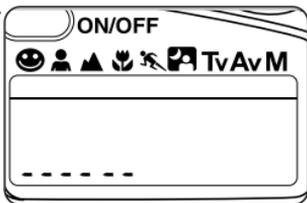

MEMO

- The camera memorizes only the exposure number and date when the batteries were removed.

LOADING THE BATTERIES



MEMO

- Be sure to use two Lithium batteries CR2 or equivalents.
- Both the camera function and the data imprinting function to keep constant track of time use the batteries.
- The optional "AA-Battery Pack FG" is also available for this camera instead of using the lithium batteries.
- Replace the batteries at the same time. Do not mix battery brands, type or an old battery with a new one.
- When the batteries were replaced, date mode will be re-set and the following camera settings will take effect.
All other settings will remain unchanged

Red-Eye-Reduction flash	Auto pop up flash	Self-timer Drive mode
Off	On	Single frame

- Keep a spare battery on hand for replacement convenience when shooting outdoors or while traveling.

Battery Life

using 24-exposure film rolls

???????????	20°C	-10°C
General existing light photography	Approx. 120 rolls	Approx. 30 rolls
Flash photography (using flash 50% of the times)	Approx. 20 rolls	Approx. 15 rolls
Flash photography (using flash 100% of the times)	Approx. 12 rolls	Approx. 5 rolls

MEMO

- CR2 batteries were used under Pentax testing conditions.
- Actual battery life and performance may vary drastically depending on usage of autofocus, built-in flash and external conditions such as temperature and freshness of the battery.
- Battery performance may be temporarily hindered in low temperatures, but it will recover in normal temperature.

Low Battery Warning

When the batteries are nearly exhausted, the battery symbol  appears on the LCD panel to warn you. Replace the batteries as soon as possible.



MEMO

- See page 19 for loading the batteries
- Even if the low-battery symbol appears, exposure will be correct as long as the shutter can be released. It is recommended to replace the batteries as soon as possible.
- When the low battery warning  starts blinking, the shutter cannot be released and no indication in the viewfinder.

TURNING ON THE POWER

- 1 Turn the power ON
Push the main switch button to turn ON.

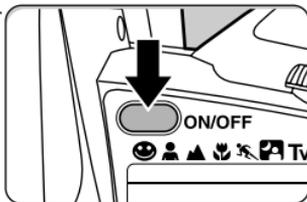

- 2 Turn the power OFF
Push the main switch button again to turn OFF.

MEMO

- Be sure to turn the main switch OFF to prevent accidental battery drain when not in used.
- If the camera is ON and left unused for over 3 minutes, the power is tuned OFF automatically.

ADJUSTING THE DATE AND TIME

- 1 Turn the power ON and depress the [DATE] button to display date mode on the LCD panel.

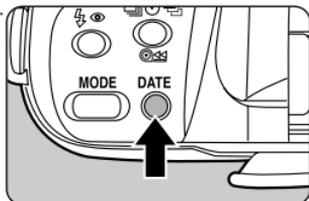

- 2 Keep depressing the [DATE] button for 3 seconds on the date mode display, the "year" digits will start to blink.

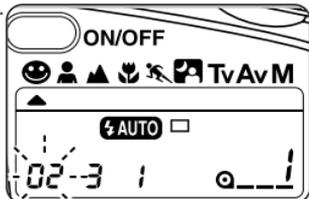

- 3 Each time the [DATE] button is depressed, the blinking digits change in the following order: Year-Month-Day-Hour-Minute-. . . Select the desired digits.

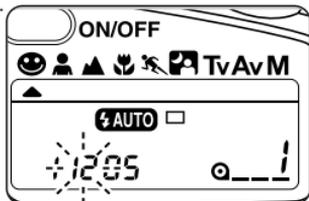

- 4** Move the Select dial to right or left to change the digits that you wish to change the blinking digits.

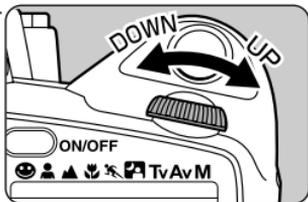

The digits increase by one each time the select dial is moved to right and the digits decreased by it's moved to left.

Holding the select dial for about one second will change the digits rapidly.

- 5** After the data has been changed, depress the [DATE] button each time until blinking stops.

- 6** Depress the [DATE] button to select your date mode that you wish to imprint on your pictures.



MEMO

Depress the [DATE] button in synchronize with a time signal to set the second to zero while (:) is blinking.

Operational precautions

- The working temperature for data printing is 0°C – 50°C (32F – 122F).
- Use DX-coded films with ISO rating from 25 – 5000.
- If high-speed film with an ISO rating of 1000 or faster is used, the imprinted characters may blur.
- If film with ISO rating of 50 or slower is used, the printed characters may be dark or dim.
- If you release the shutter while the blinking data is being corrected, the data cannot be imprinted.

SETTING THE DATA BACK

The DATE model records date information on your pictures clearly on each frame that you expose.

Selecting the date mode

- 1** At each depress of the [DATE] button, the display on the LCD panel changes as follows. (Av/Tv)→(Date mode)→(Av/Tv)

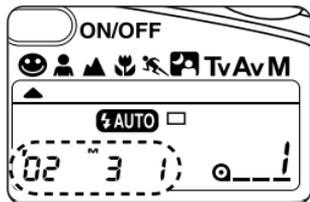
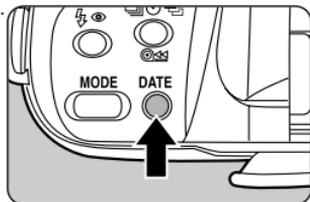

- 2** While the date mode is displayed, at each depress of the [DATE] button as shown in the illustration, the date mode on the LCD panel of the data changes as indicated in the chart.

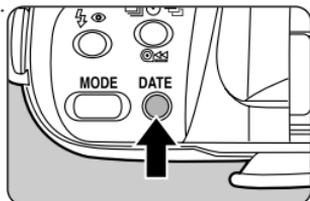

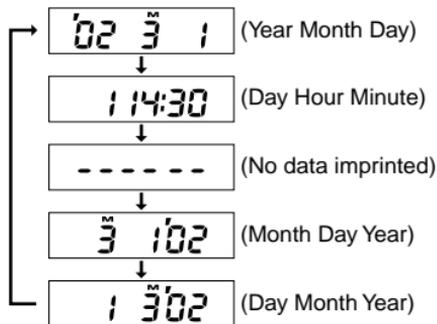

MEMO

- [M] on the LCD indicates "Month".
- Year 2000 will imprint " 00 " on pictures.
- [-- --] indicates that no data will be imprinted.
- If there is a white or yellow object in the left bottom corner of the picture where the data is imprinting, the data may be difficult to read. When composing your picture, try to avoid brightly colored subject in that corner.
- The data operates on power for the 6V lithium battery camera. If the camera batteries were removed or replaced, data setting will be initialized to "[-- --] no data imprinted ", need to adjust the date and time.

ATTACHING THE LENS

- 1** Remove the body mount cap 1 and rear lens cap 2.

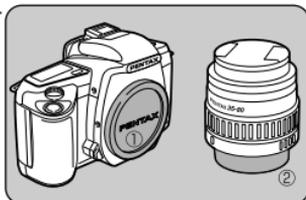

- 2** Align the red dots on the lens and camera while mounting the lens to the camera body, then turn the lens clockwise until it clicks in place.

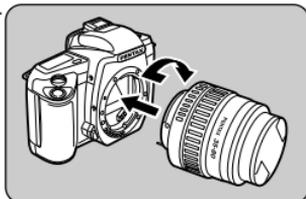

- 3** To remove the front lens cap, squeeze the tabs on both sides in the direction of the arrow.

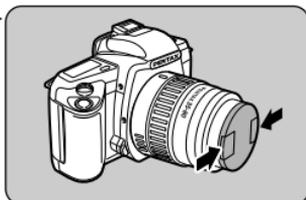

- 4** To remove the lens, hold down the lens unlock button and turn the lens counterclockwise.

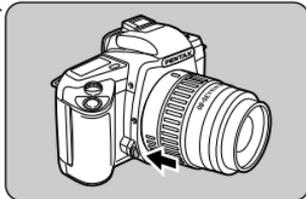

 **MEMO**

- The body mount cap is designed to protect the camera against scratches and dust at the factory. For storage, the optional accessory "Body Mount Cap K" is available.
- After mounting the lens, try to turn the lens counterclockwise to make sure it is locked in place.
- The camera body and lens mount incorporate lens information contacts and an AF coupler. Dirt, dust, or corrosion may cause damage to the electrical system. Clean the contacts with a soft, dry cloth.
- We assume no responsibility nor liability for damages resulting from the use of lenses made by other manufacturers.
- To protect the lens information contacts and AF coupler of the lens against damage after removal, be sure to place the lens down with the mount side upward.

FILM LOADING

We suggest that you first operate the camera with no film loaded to become familiar with its operations.

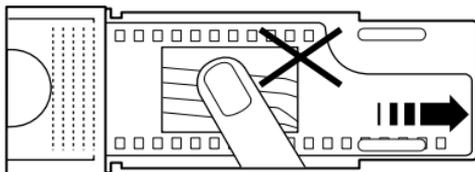

MEMO Remove the protective card

- Before loading film for the first time after purchase, open the back cover and remove the protective card.
- Be careful not to touch the shutter curtains with protective cover.
- Always load and unload the film in the shade or avoid direct sunshine.

- 1 To open the back cover, slide the back cover release lever down in the direction of the arrow.

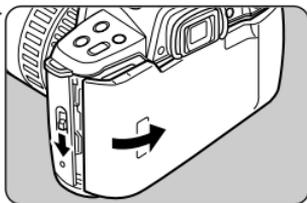

- 2 Place the film cartridge in the film chamber as shown in the illustration.

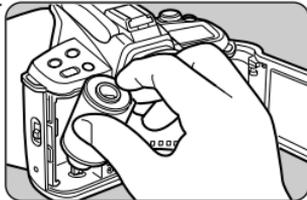

- 3 Pull the film leader out far enough to reach the take-up spool.

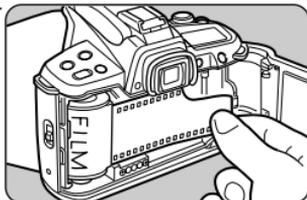

★ Important

The shutter curtains are made from fine precision material. Do not touch them with your fingers or any other object while loading the film.

4 Align the film leader with film leader end mark 1 as shown as illustrated.

- If you pulled out too much film, push it back into the cartridge to reduce the slack.
- Make sure that the film leader is positioned under the film retainer and the film perforations properly engaged on the sprocket tooth.

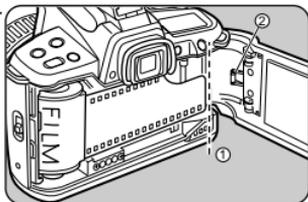

Note

- The DX information pins in the film chamber are used to read film speed. Keep them clean and free from scratches. To remove smudges, wipe them gently with a soft, dry cloth.

5 Close the back cover and turn the main switch ON.

The film will be advanced to first frame automatically and the exposure counter 1 and film status information appear on the LCD panel when film is loaded properly.

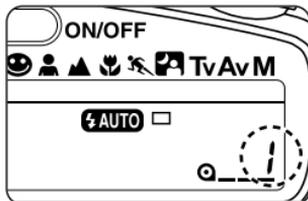
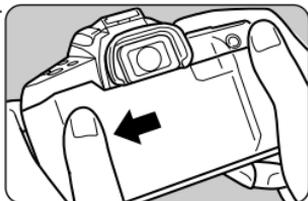

**MEMO Incorrect film loading**

If the film is not loaded properly, (E) will blink on the LCD panel. Open the back cover and load the film again.

Note

- Automatic film speed setting
When DX-coded film is used, the correct film speed is automatically set for the camera. If you use a non-DX coded film, you can set the film speed manually. See page xx

OPERATING THE SHUTTER RELEASE BUTTON

The shutter release button has two positions. Depressing it down halfway (first position) turns on the exposure meter and autofocus system.

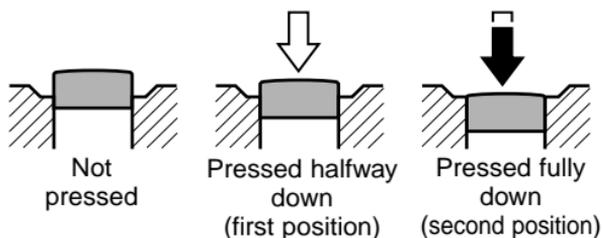

Depressing it fully (second position) releases the shutter. When taking a picture, depress the shutter release button gently to prevent camera shake.

MEMO

- To prevent camera shake, depress the shutter release button gently.
- Before loading a roll of film, slowly depress the shutter release button to learn where the first position is.
- The LCD indication stays on for about 10 seconds after the button is released from the halfway position. Depressing the shutter release button down halfway keeps the LCD indicator on.

2

BASIC OPERATION (SHOOTING)

- Step 1** SET THE STANDARD PROGRAM MODE . . .XX
- Step 2** SET THE SUTO POP-UP FLASHXX
- Step 3** SET THE SINGLE FRAME DRIVE MODE . . .XX
- Step 4** SET THE AUTO FOCUS MODE TO AFXX
- Step 5** USING THE ZOOM LENSXX
- Step 6** HOLDING THE CAMERAXX
- Step 7** TAKING A PICTUREXX
- Step 8** UNLOADING A FILMXX
- Step 9** REWINDING A FILM IN MID-ROLLXX

SET THE STANDARD PROGRAM MODE

For quick and easy shooting, set your camera for Standard program mode, autofocus, auto flash and single frame drive mode.

This standard program mode allows you to take pictures by simply depressing the shutter release button. The camera selects the best combination of aperture and shutter speed setting.

1 Set the lens aperture ring to the **A** position.

To set the lens aperture ring to the **A** position, turn the aperture ring while holding down the aperture-A lock button on the lens.

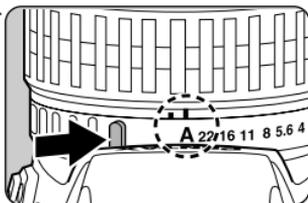

2 Set the pointer mark **▲** to **☺** by moving the select dial while depressing the exposure mode button.

When the shutter release button is depressed halfway down, the shutter speed (TV) and aperture value (AV) are displayed on the LCD panel

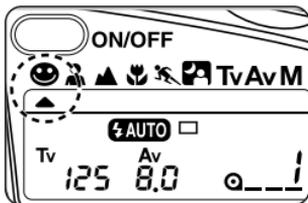
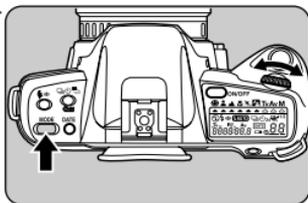

MEMO

- The shutter cannot be released when an F, FA or A lens is attached with the aperture ring set to other than **A** position

SET THE AUTO POP UP FLASH

- 1 Depress the flash mode button until **⚡AUTO** appears on the LCD panel.

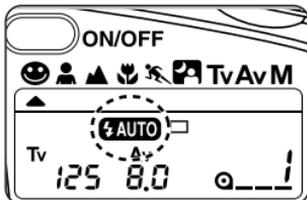
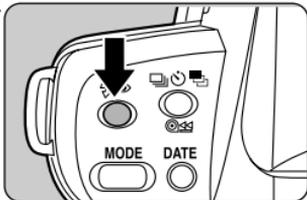

- 2 In this mode, the built-in flash automatically pops up when depressing the shutter button halfway down in the low light or backlight conditions.

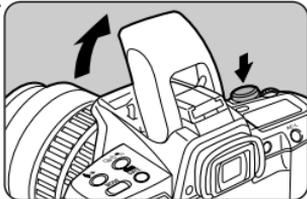

MEMO

- The Built-in flash does not retract automatically, push the built-in flash down into the camera body after use.
- The built-in flash does not discharge when not required even though it has been in the up position. See page xx for more details.
- Do not use a lens hood when the built-in flash is used, as it may obstruct the path of the light coming from the flash, causing vignetting in the picture corners.

SET THE SINGLE FRAME DRIVE MODE

One picture is taken each time the shutter release button is depressed.

Depress the drive mode button until single frame  appears on the LCD panel.

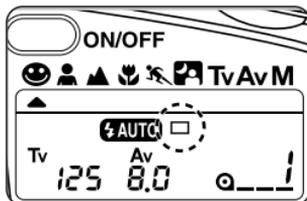
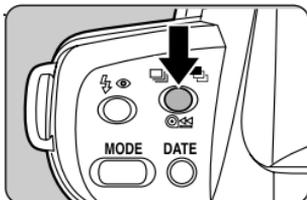

MEMO

The drive mode can also be set to consecutive-frame mode , self-timer , 2 seconds self-timer  or auto bracket shooting mode .

SET THE AUTO FOCUS MODE TO AF

When the shutter release button is depressed halfway down, the lens adjusts focus automatically.

Set the focus mode switch to **AF** in the down position.

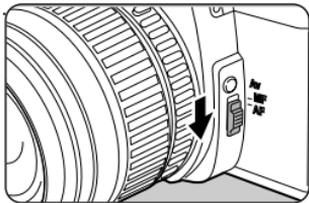

MEMO

- The picture cannot be taken unless focus is achieved. The focus will remain locked as long as shutter release button is held in halfway down.
- See page xx to xx for manual focusing.

USING THE ZOOM LENS

Turning the zoom ring to the right makes the subject appear larger (telephoto) and turning it to the left makes the subject appear smaller (wide angle).



MEMO

- The smaller the number shown on the zoom scale ring, the wider the angle. Conversely, the larger the number, the more magnified the image appears.
- The Image Size Tracking Mode, Zoom Clip Mode, Auto Zoom Effect Mode and Power Zoom function do not operate with this camera even if an FA lens is attached.



Telephoto



Wide angle

HOLDING THE CAMERA

Hold the camera firmly, with your left hand supporting the camera and lens as shown in the illustrations.

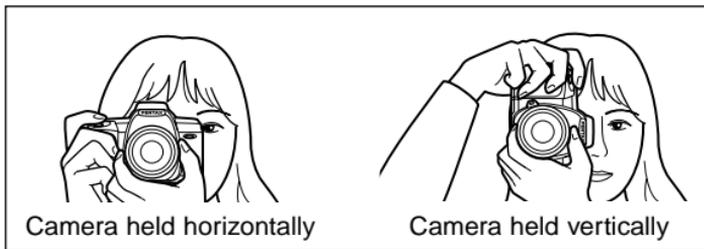

MEMO

- While taking a picture, gently depress the shutter release button. Sudden force on the shutter release button will cause camera shake, making the picture blurred.
- To reduce camera shake, support your body or the camera on a solid object - a table, tree, or a wall for instance.
- When using an telephoto lens, a tripod that is heavier than the total weight of the camera and lens is recommended to avoid camera shake.
- Although there are individual differences among photographers, in general the shutter speed for a hand held camera is the inverse of the focal length. For example, 1/50 of second for focal length is 50mm, and 1/100 of second for it is 100mm. A tripod should be used for shutter speeds slower than this.

TAKING A PICTURE

- 1** Confirm that the focus mode switch has been set to **AF** and the lens aperture ring has been set to **A**, and select the data mode to imprint or not.

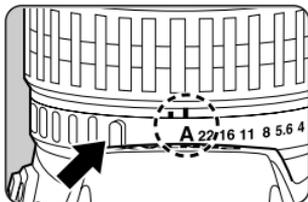
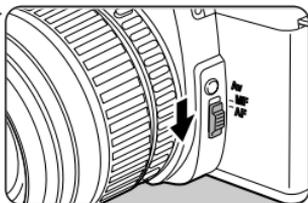

- 2** Frame the subject
Look through the viewfinder and frame the subject with the autofocus **AF** frame **C**.
- When the shutter release button is depressed halfway down, the lens adjust focus automatically.



- 3** Confirm that the shutter speed, aperture value, picture mode on the LCD panel.

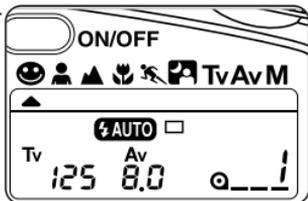

4 When the subject is in focus, the focus indicator in the viewfinder  lights up.

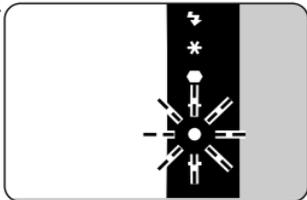

- The focus indicator  blinks when the camera is not able to obtain proper focus for one of the following reasons.
 1. The subject is too close. Adjust the camera-to-subject distance.
 2. The subject is difficult to autofocus. See "HARD-TO-AUTOFOCUS" subject on page xx.

5 Take a picture.
Gently depress the shutter release button completely.
The built-in flash pops up automatically when the subject is not lighted adequately.

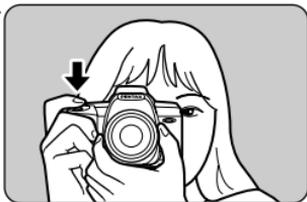

 **MEMO**

- The shutter cannot be released if the subject is out of focus.
- Depress the shutter release button halfway down. While  is on, the camera-to-subject distance is fixed (Focus lock). To refocus on another subject, lift your finger off the shutter release button.

UNLOADING A FILM

- 1 The film automatically rewinds at the end of the roll.**

During rewinding,  blinks on the LCD panel, indicating that the film is being rewound, the exposure counter counts frame numbers in reverse.

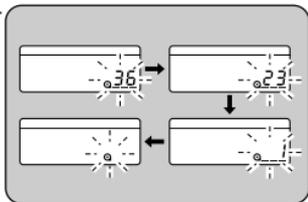

- 2 When the film is fully rewind, only  blinks on the LCD panel.**

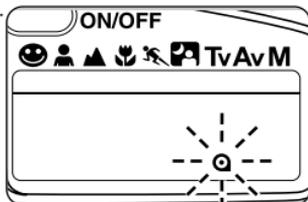

- 3 Open the back cover and remove the film.**

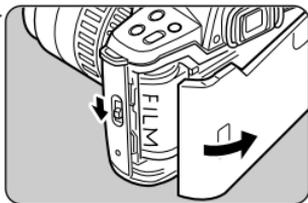

MEMO

- When removing the film from the camera, avoid direct sun light.
- A roll of 24-exposure film takes about 20 seconds to rewind.
- Before opening the back cover, check that  is blinking.
- The shutter may be released a frame or more after the specified number of frames have been used as indicated on the film cartridge. However, those extra frames may be lost in processing. When you take important pictures, rewind the film when the film reaches the number of frames indicated on the film cartridge.

REWINDING A FILM IN MID-ROLL

If you wish to unload the film before exposing all the frames, use this function.

1 Set the main switch to the ON position, Depressing the Drive mode button for over 2seconds, Film status information  will appear on the LCD.

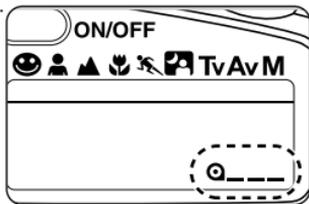

2 Holding the drive mode button and depress the shutter release button to start rewinding. When the film is fully rewound, only  blinks on the LCD panel.

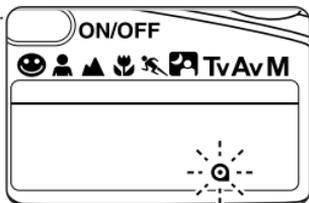

- The film will be rewound, Film status information on the LCD panel blinks and counts the frame numbers in reverse.
- Before opening the back cover, check that  is blinking.

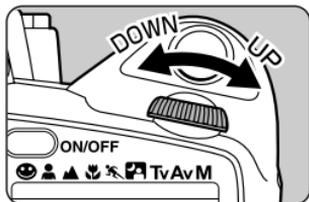

3

ADVANCED OPERATIONS

SELECTING A DRIVE MODE	45-50
CONSECUTIVE-FRAME DRIVE MODE	46
SELF-TIMER MODE	47
AUTO BRACKET EXPOSURE MODE	49
SELECTING 6 PICTURE MODES	51-58
7. STANDARD PROGRAM MODE	53
8. PORTRAIT PROGRAM MODE	54
9. LANDSCAPE PROGRAM MODE	55
10. ACTION PROGRAM MODE	56
11. CLOSE-UP PROGRAM MODE	57
12. NIGHT-SCENE PROGRAM MODE	58-59
EFFECT OF APERTURE AND SHUTTER SPEED	61
SELECTING ANOTHER EXPOSURE MODES	61-69
4. APERTURE -PRIORITY AE MODE	61
5. SHUTTER- PRIORITY AE MODE	63
6. METERED MANUAL MODE	65
AE LOCK FNCTION	70
MANUAL FOCUSING	71
HARD-TO-AUTOFOFUS SUBJECTS	73
USING BUILT-IN FLASH	74
SELECTING THE VARIOUS BUILT-IN FLASH MODES	
RED-EYE REDUCTION FLASH FUNCTION	76
ABOUT RED-EYE PHENOMENON	76
FLASH EFFECTIVE RANGE FOR THE PICTURE MODE WITH ISO	
100 (400) FILM USED	77
MANUAL POP UP THE BUILT-IN FLASH	78
FLASH OFF MODE	80
DAYLIGHT-SYNC SHOOTING	81
ADVANCED OPERATION FOR BUILT-IN FLASH	82
COMPATIBILITY OF F AND FA LENSES WITH THE BUILT-IN FLASH	85
SETTING THE FILM SPEED (ISO) MANUALLY	87
OVERVIEW OF FLASH FUNCTION	88
USING PENTAX DEDICATED AUTO FLASH	90
SLOW-SPED=SYNC SHOOTING	94

SELECTING A DRIVE MODE

This camera has a total of six drive modes as shown.

<p>Single-Frame Drive Mode</p> 	<p>One picture is taken each time the shutter release button is depressed.</p>
<p>Consecutive-Frame Drive Mode</p> 	<p>Pictures can be taken consecutively while holding down the shutter release button. See page 38</p>
<p>Self-timer Mode</p> 	<p>A picture will be taken with a 12-second-delay. See page xx.</p>
<p>2 Seconds self-timer Mode</p> 	<p>A picture will be taken with a 2-second-delay. See page xx</p>
<p>Auto Bracket Exposure Mode</p> 	<p>See page 40 for more details.</p>
<p>Auto Bracket Exposure Mode</p> 	<p>See page 40 for more details</p>

Consecutive-Frame Mode

Pictures can be taken consecutively while holding down the shutter release button.

Setting the consecutive frame drive mode

Depress the drive mode button until  appears on the LCD panel.

1. Depress the shutter release button halfway down to focus on the subject.
2. Depress and hold down the shutter release button completely.
3. Take your finger off from the shutter release button to stop taking pictures.

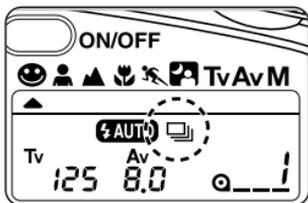
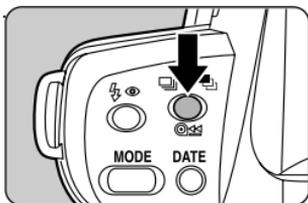

MEMO

- The shutter cannot be released while the built-in flash is being charged.
- Depress the drive mode button to another setting to cancel the consecutive-frame drive mode.

SELECTING A DRIVE MODE

Self-timer Mode

The self-timer mode delays the shutter release, and is useful for taking group shots that include the photographer or when you wish to prevent camera shake for slow speed exposure as close-up or night- scene pictures. The shutter will be released about 2 seconds or 12 seconds after the shutter release button is depressed fully.

- 1 Depress the drive mode button until  appears on the LCD panel.

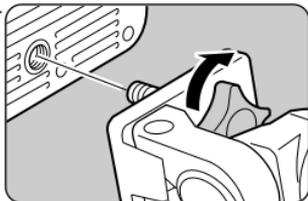

- 2 Focus on the subject first using the autofocus frame and by depressing the shutter release button halfway down.

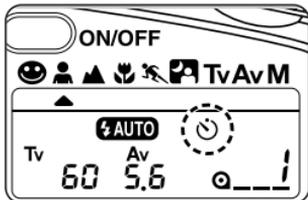
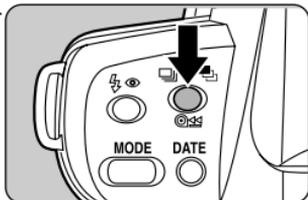

3 Then depress the shutter release button fully to start the self-timer

When the self-timer is in operation, the self-timer lamp blinks and the rate increases for the last two seconds

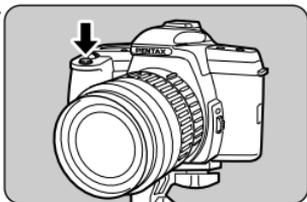

MEMO Preventing stray light entering the eyepiece

Underexposure may occur if light enters the viewfinder during self-timer operation. If you intend to move away from the viewfinder, attach the supplied finder cap as shown in the illustration. When using accessories such as the finder cap, remove the Eyecup FK as illustrated. The Eyecup FK comes from the factory fitted to the camera's viewfinder accessory grooves.

MEMO

- Use of tripod is recommended.
- When the 2 seconds self-timer is used, depress the shutter release button to starts, lock-up the reflex mirror to prevent camera shake and shutter will be released about 2 seconds later.
- To cancel the self-timer operation after it has been activated, depress the drive mode button to disappear  from the LCD panel.

AUTO BRACKET SHOOTING

When you depressed shutter release button, three consecutive frames will be taken at the different exposure times. The first frame is exposed with no compensation. The second frame is under exposed and the third frame is over exposed. The bracketing amount can be set to $\pm 1/2$ EV or ± 1 EV.



??????????



??????????



??????????

- 1** Depress the drive mode button until  or  appears on the LCD panel.

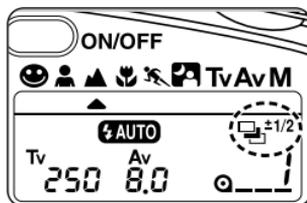
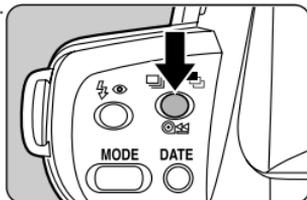

2 Focus on the subject by depressing the shutter button halfway down.

The focus is locked at the first picture and remains locked until 3 pictures are taken.

Take 3 consecutive pictures, depress and hold down the shutter release button.

MEMO

- If you take a finger off from the shutter release button during auto bracketing, the auto bracketing mode will remain effective for about 20 seconds. After that, the auto bracketing exposure for the first bracketed frame will take effect.
- Auto bracket does not work in the Bulb timer Mode.
- If the exposure compensation amount is small, the effect will not be noticeable with print film.
- Only the amount of light of the flash can be changed continuously by using the auto bracketing mode following completion of charging of the built-in flash or external flash unit (TTL and P-TTL Auto only). However, in case of an external flash unit, if three consecutive frames are taken while depressing the shutter button, the second and third frame may be taken prior to completion of charging. Always make sure to check completion of charging for each time.

How to cancel

Auto bracket can be canceled if the power is turned OFF or any other drive mode is set.

SELECTING 6 PICTURE MODES

You can select your desired Picture Mode by depressing the exposure mode button. The picture mode has a total 6 modes as follows. See details for each mode on page xx to xx.

Setting the one of 6 picture modes

	Standard Program Mode	????????????????????????????
	Portrait Program Mode	????????????????????????????
	Landscape Program Mode	????????????????????????????
	Close-up Program Mode	????????????????????????????
	Action Program Mode	????????????????????????????
	Night-scene Program Mode	????????????????????????????

1 Set the lens aperture ring to

A.

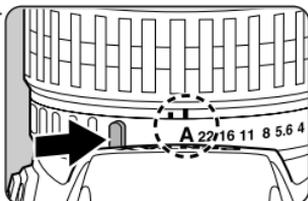

2 Set the pointer mark ▲ to the desired exposure mode symbols () by moving the select dial to left or right while depressing the exposure mode button.

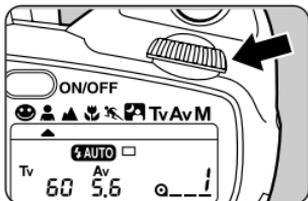
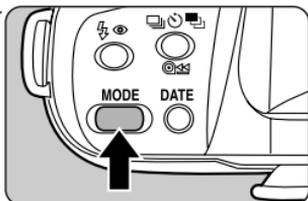

Exposure Warning

If the subject is too bright or too dark, the flash recommended indicator in the viewfinder would blink. If the subject is too bright, select a darker subject. Use a flash if the subject is too dark.

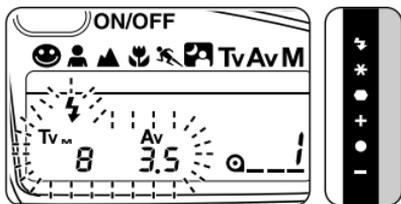

SELECTING 6 PICTURE MODES

Standard program Mode

For easy picture taking, use this Standard program Mode. You simply depress the shutter release button. The camera selects the best combination of aperture and shutter speed setting.



- 1 Set the pointer mark  to  by moving the select dial while depressing the exposure mode button.

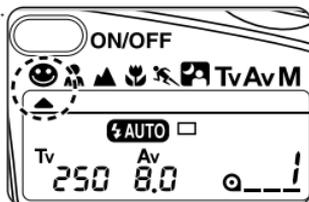

- When the shutter release button is depressed halfway, the shutter speed and aperture setting are displayed on the LCD panel.

Portrait Program Mode

This mode is suitable for taking portrait photography.



- 1 Set the pointer mark  to  by moving the select dial while depressing the exposure mode button.

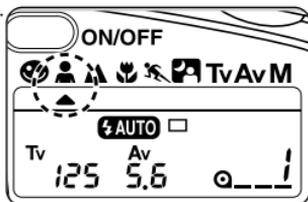

- When the shutter release button is depressed halfway down, the shutter speed and aperture setting are displayed on the LCD panel.

MEMO

In this mode, the telephoto lens produces a portrait in crisp focus against the out-of-focus background, while the wide-angle lens enables you to shoot group photography or snapshots in sharp and clear focus with the extended depth-of-field.

Landscape Program Mode

This mode is ideal for landscape photography and scenic snapshots.



- 1 Set the pointer mark  to  by moving the select dial while depressing the exposure mode button.

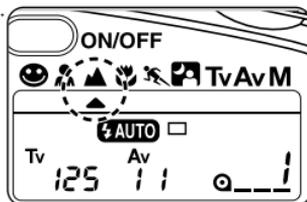

- When the shutter release button is depressed halfway down, the shutter speed and aperture setting are displayed on the LCD panel.

When a landscape photograph is taken in this mode, the resulting photograph will be in focus for entire landscape, including objects close-up and these in the distance.

Close-up Program Mode

This mode is convenient when taking close-up photos of flower and so forth. This mode favors smaller apertures to maximize the depth of field, ensuring sharp focus of a close-up subject.



- 1 Set the pointer mark  to  by moving the select dial while depressing the exposure mode button.

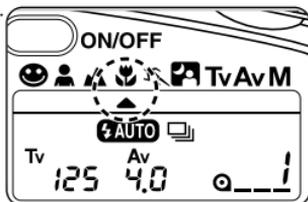

- When the shutter release button is depressed halfway down, the shutter speed and aperture setting are displayed on the LCD panel.

SELECTING 6 PICTURE MODES

Action Program Mode

This mode selects a faster shutter speed to capture a moving subject and prevents blurred images. This mode is especially convenient for active photography. It is also suitable for portraits with blurred background.



- 1 Set the pointer mark  to  by moving the select dial while depressing the exposure mode button.

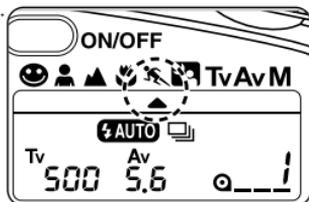

- When the shutter release button is depressed halfway down, the shutter speed and aperture setting are displayed on the LCD panel.

MEMO

- This mode focus on the subject continuously when the shutter release button is depressed half way down, and the shutter can be released whenever the subject is in focus or out of focus.
- If the subject is moving too fast, the shutter may not be released.

Predictive Autofocus Mode

When the camera senses subject movement during the autofocus operation, the camera will automatically switch the focus mode to the predictive autofocus mode to measure the speed of a moving subject, and predict where it will be at the moment of shutter release to maintain sharp focus on the subject.

Night-scene Program Mode

This mode is useful when taking a portrait photograph with a night scene in the background.



- 1 Set the pointer mark  to  by moving the select dial while depressing the exposure mode button.

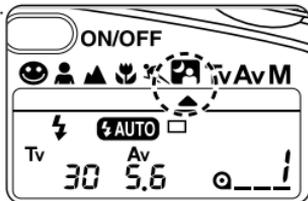

- 2 Press the flash pop up button to activate the flash if auto pop up flash is not selected.

- When the shutter release button is depressed halfway down, the shutter speed and aperture setting are displayed on the LCD panel.

MEMO

It is possible to photograph subjects and background in a balanced way by using the flash to properly expose the foreground subject and a slow-speed to expose the low light background. The shutter speed automatically changes in the range of 1/100 to 2second.

- Use of a tripod is recommended.
- The Standard program mode is automatically set when the built-in flash is not in use.

EFFECT OF APERTURE AND SHUTTER SPEED

A correct exposure is established by a combination of shutter speed and aperture setting according to the subject brightness. There are many correct combinations of shutter speed and aperture for a particular subject brightness. Different shutter speed and aperture settings produce different effects.

Effect of shutter speed

The shutter determines the film exposure times, or the length of time that the light is allowed to strike the film.

If the subject is moving, the image will be blurred when a slow shutter speed is used.

It is possible to enhance the effect of motion, (The movement of a water waterfall) by intentionally using a slower shutter speed.

Choosing a faster shutter speed will allow the image of a moving subject to be frozen. A faster shutter speed also helps prevent camera shake.



Effect of aperture

The aperture increases or reduces the amount of reflected light from an object which passes through the lens, controlling how much light strikes the film. If the aperture is opened up to increase the amount of light, subjects in front of and behind an in-focus subject will not be focused. That is the range of focus (depth of field) becomes small. If the aperture is stopped down to reduce the amount of light, the depth of field increases. For instance, if you shoot a person against a landscape with the aperture open, the landscape in front of and behind the person will be blurred, making the person appear to rise out of the landscape. By contrast, stopping down the aperture increases the in-focus range.



Aperture-Priority AE Mode

When the desired aperture is selected, the appropriate shutter speed is automatically set by the camera for a proper exposure according to the brightness of the subject. This mode is ideal for shooting landscapes with increased depth of field, or a portrait against a blurred background.

- 1** Set the lens aperture ring to **A**.

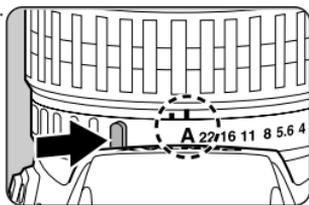

- 2** Set the pointer mark  to **Av** by moving the select dial while depressing the exposure mode button.

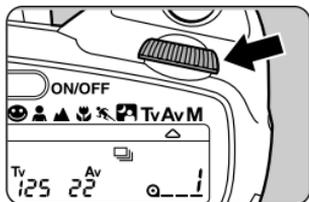
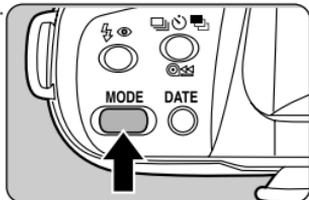

- 3** Select the desired aperture by moving the select dial while depressing the AV button.

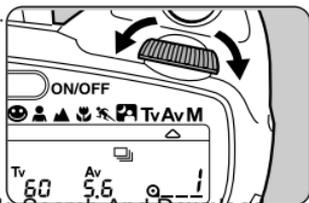

4 ??????????????????????????????
 ??????????????????????????????
 ?????

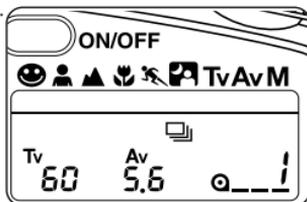

- When the shutter release button is depressed halfway down, the shutter speed and aperture value will be displayed on the LCD panel.

Exposure Warning

If the subject is too bright or too dark, the plus **+** or minus **-** indicator in the viewfinder and the selected shutter speed on the LCD panel would blink slowly as a warning as shown.

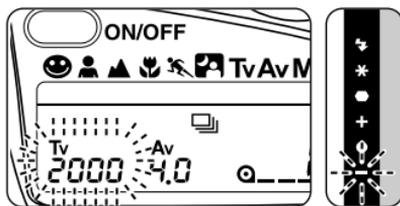

When the subject is too bright, choose a smaller aperture, if available; when it is too dark, choose a larger aperture, if available. When the shutter speed indication stops blinking, you can take the picture. If both plus **+** and minus **-** blink rapidly, it means that the exposure is out of metering range, unable to obtain a correct exposure even if the aperture is adjusted. Select a darker subject if it is too bright, or use a flash if it is too dark.

Shutter-Priority AE Mode

When the desired shutter speed is selected, the appropriate aperture is automatically set by the camera for a proper exposure according to the brightness of the subject. This mode is suitable for freezing the action with a fast shutter speed or capturing a flowing dynamic image with a slow shutter speed.

- 1** Set the lens aperture ring to **A**.

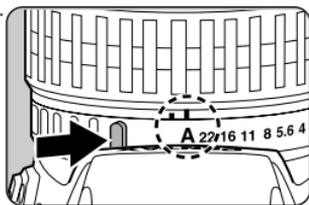

- 2** Set the pointer mark  to **Tv** by moving the select dial while depressing the exposure mode button.

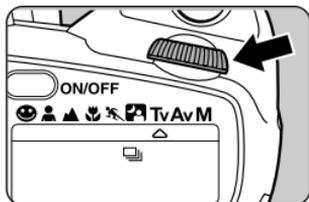
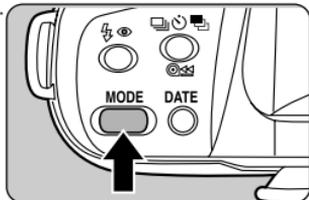

- 3** Select the desired shutter speed by moving the select dial.

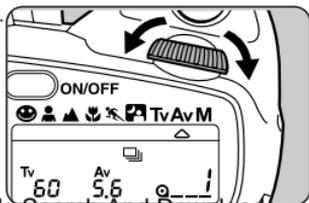

4 ??????????????????????????????
 ??????????????????????????????
 ?????

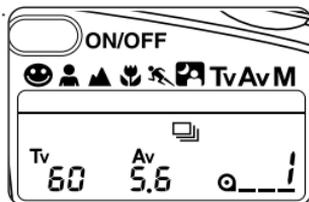

- When the shutter release button is depressed halfway down, the shutter speed and aperture value will be displayed on the LCD panel.

* Exposure Warning

If the subject is too bright or too dark, the plus  or minus 

indicator in the viewfinder and the selected aperture value on the LCD panel would blink slowly. When the subject is

too bright, choose a faster shutter speed. If it is too dark, choose a slower shutter speed. When the selected aperture value stops blinking, you can take the picture. If both selected shutter speed and aperture blink, it means that the exposure is out of metering range, unable to obtain a correct exposure even if the shutter speed is adjusted. Select a darker subject if the subject is too bright. Use a flash if it is too dark.

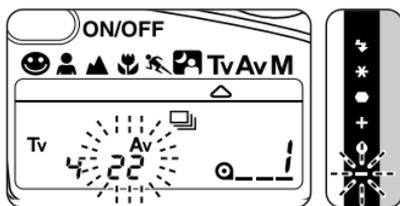

Metered Manual Mode

The manual exposure mode is a convenient exposure mode for taking pictures using the same shutter speed and aperture setting combination, or taking creatively under or over exposed photographs.

- 1** Set the lens aperture ring to **A**.

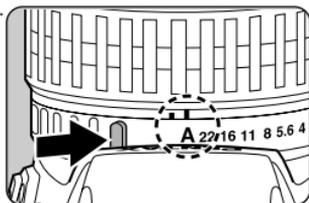

- 2** Set the pointer mark  to **M** by moving the select dial while depressing the exposure mode button.

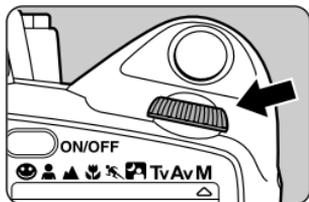
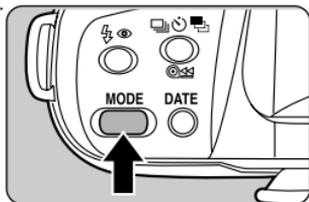

- 3** Move the select dial to change the shutter speed.

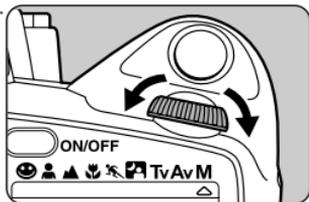

- 4** Move the select dial to change the aperture value while holding the AV button.

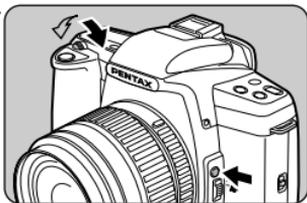

- 5** Confirm the shutter speed and aperture value on the LCD panel.

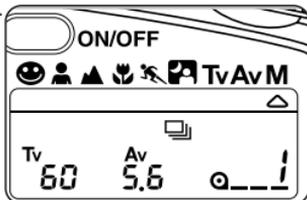

- 6** in the center indicates the correct exposure.
 indicates over exposure.
 indicates under exposure.

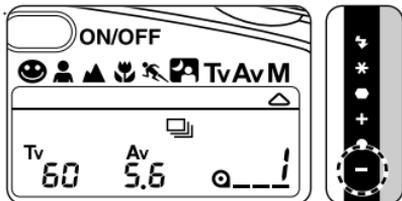

When under or over exposure is set beyond + 1 or - 1 steps (1EV), or indicator will light.

When under or over exposure is set less than + 1 or - 1 steps (1EV), or indicator will light.

EFFECT OF APERTURE AND SHUTTER SPEED



MEMO

The AE lock does not operate in the Metered Manual Mode.

Exposure Warning

If both   blink in the viewfinder and both shutter speed and aperture value blink on the LCD panel, it means that the exposure is out of metering range.

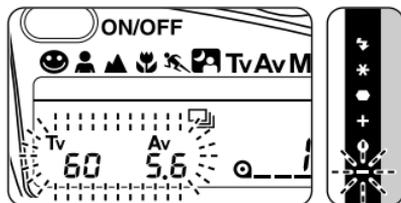

BULB TIMER EXPOSURE MODE

This mode is useful for the long exposures required for shooting night scenes and fireworks. The shutter speed can be set from 45seconds to 32minutes as follows.

45sec, 1min., 1.4min., 2min., 2.8min., 4min., 5.6min., 8min., 11min., 16min., 22min., 32min.

- In the Metered Manual Mode, move the select dial to change the shutter speed to desired slower shutter speed appears on the LCD panel.**

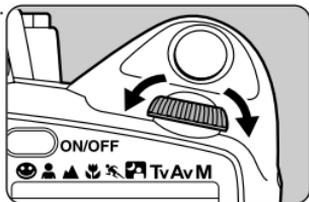

- When using this mode, use a steady tripod to prevent camera shake and gently depress the shutter release button.**

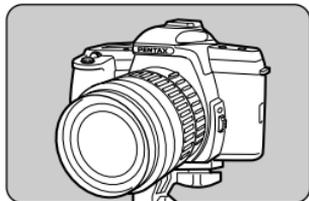

MEMO

- The shutter remains open for selected shutter speed.
-    indicators will not light in this Bulb timer mode.

AE LOCK FUNCTION

The AE Lock function enables an exposure level lock before picture is taken.

If the subject is too small for a proper exposure setting to be obtained, you can zoom in on the subject to obtain the proper exposure setting. Then lock the exposure setting and recompose shot before taking a picture.

To use the AE Lock:

- 1 Position the area to be measured in the viewfinder metering area and press the AE lock button **AE-L**. To cancel the AE lock, press the AE lock button again.

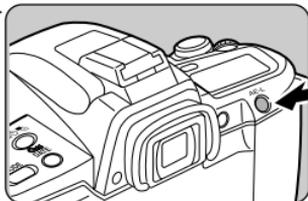

- 2 ***** is displayed in the viewfinder. The measured exposure level is locked for 20 seconds.

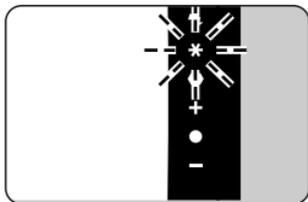

- 3 Recompose the image in the viewfinder and take the picture.

MEMO

- If the shutter release button is depressed halfway down while the AE lock timer is operating, the memorized meter reading will remain even if the AE lock button is released.
 - The auto-popup built-in flash function does not work while the AE lock is in use.
 - AE lock does not work in the Metered Manual Mode and Bulb timer Mode.
- Download from [Www.Somanuals.com](http://www.Somanuals.com). All Manuals Search And Download.

MANUAL FOCUSING

Using a manual focus lens

When you adjust focus manually, you can either look at the focus indicator  in the viewfinder or the viewfinder matte field to check if the subject is in focus.

You can use the manual focus mode to adjust focus with the aid of the focus indicator  in the viewfinder.

How to focus with aid of the in-focus indicator

- 1 Set the focus mode switch to **MF**.

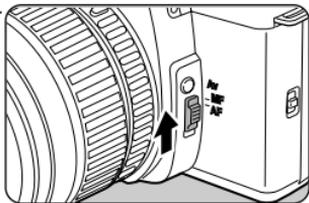

- 2 Frame the subject, then depress the shutter release button halfway down.



- 3 While looking through the viewfinder, turn the focusing ring to right or left until the subject is in focus.

When the subject comes into focus, the focus indicator  lights up in the viewfinder.

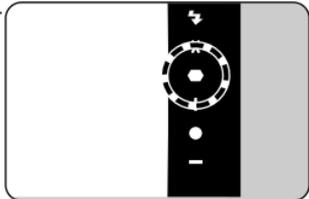

- 4**
Depress the shutter release button fully to take a picture.

When the autofocus mode or the focus indicator is unsuitable for focusing.

When the autofocus function or the viewfinder focus indicator  in the viewfinder cannot be used for focus confirmation for the following reasons, focus on the subject in the manual focus mode with the aid of the matte field in the viewfinder as you would with a non-AF SLR camera.

- a) The focus indicator  blinks because the subject is difficult to autofocus.
- b) The maximum aperture of the lens in use is smaller than f/5.6.

How to focus with aid of the matte field

- 1 Set the focus mode switch to **MF**.

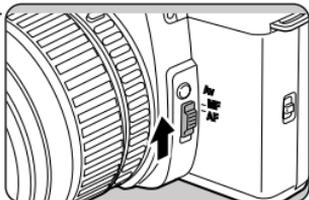

- 2 Frame the subject, then turn the focusing ring to the right or left until the subject looks sharp in the viewfinder.



- 3 Depress the shutter release button fully to take a picture.

MEMO

When the special effect filter or Magic Image Attachment or Stereo Adapter is used, the auto focusing and manual focusing with the in-focus indicator in the viewfinder will not work. Use the manual focus mode to focus on the subject with aid of the matte field.

HARD-TO-AUTOFOCUS SUBJECTS

The autofocus system is highly precise, but not perfect.

Depending on the brightness, contrast, shape, and size of your subject, the autofocus system may not operate. In such a case, set the focus mode switch to **MF** and use the manual focus mode to focus the lens on the subject with the aid of the matte field in the viewfinder (see page xx).

Subjects, which may fool the autofocus system, include:

- a) Extremely low-contrast subjects such as a white wall in the autofocus frame .
- b) Subjects which don't reflect much light in the autofocus frame .
- c) Subjects that are moving too fast.
- d) Multiple subjects in the foreground and background of the autofocus frame .
- e) Subjects positioned against reflected light or strong backlight or with extremely bright backgrounds.

SETTING THE FILM SPEED (ISO) MANUALLY

This camera automatically reads the film speed from the film's DX code. However, the film speed setting can be changed. If you use a non-DX coded film, set the film speed manually.

How to set

1. Load the Non-DX corded film.

Move the select dial until **ISO** appears on the LCD panel while depressing the exposure mode button.

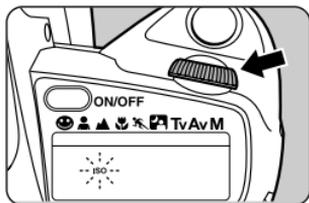
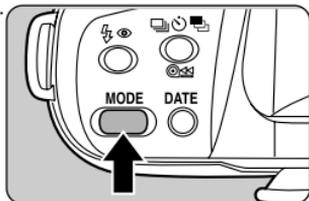

2. Move the select dial to set ISO film speed displayed on the LCD panel.

After the ISO is set, move the select dial until the your desired exposure mode other than ISO.

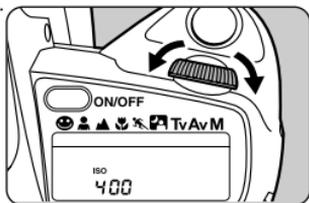

MEMO

- To change the ISO, turn the select dial to the left for a smaller number (Slower film speed, or right for a larger number (Faster film speed).
- The shutter cannot be released when **ISO** is displayed on LCD.
- **ISO** is displayed when the film speed is set manually.

USING BUILT-IN FLASH

Auto-popup flash function

The auto-popup flash function operates with the one of 6 picture modes is set.

In this mode, the built-in flash pops up and discharges automatically in low light and backlight condition.

- 1** Depress the flash mode button until  appears on the LCD panel.

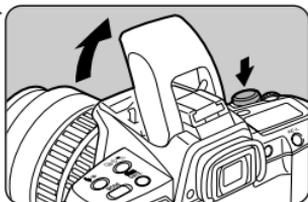

- 2** Depress the shutter release button halfway down, and the built-in flash automatically pops up when the flash is required.

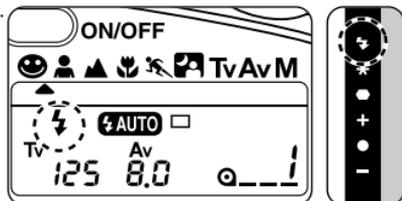

MEMO

- The built-in flash does not retract automatically, push the built-in flash down into the camera body after use.
- The built-in flash does not discharge when not required even though it has been in the up position.
- Do not use the lens hood when the built-in flash is used, as it may obstruct the path of the light coming from the flash, causing vignetting in the picture corners.
- When using an inappropriate For FA lens, () will blink rapidly in the viewfinder and on the LCD panel when the shutter release button is depressed halfway down. For more details on COMPATIBILITY OF F AND FA LENSES WITH THE BUILT-IN FLASH, see page 89.
- If the built-in flash is used continuously, the battery may become warm, but it does not mean that the battery is faulty; it's one of the battery's characteristics.
- The shutter cannot be released until the flash is fully charged.

SELECTING THE VARIOUS BUILT-IN FLASH MODES

At each depress of the flash mode button, the flash mode on the LCD panel changes as shown in the chart

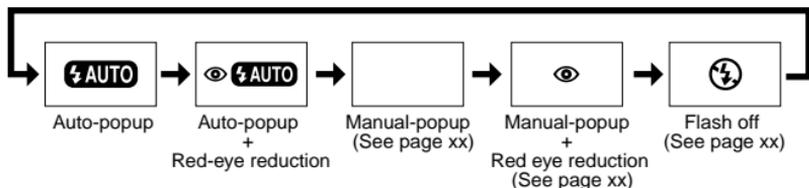
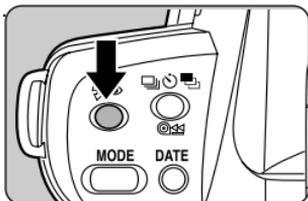

MEMO

- The auto-popup flash mode can only be set when one of 6 picture modes is selected.
- The built-in flash pops up automatically when  AUTO is displayed on the LCD panel. But it discharges only when required. (Automatic flash function)
-  AUTO or  can only be set when one of 6 picture modes is selected.
- The auto-popup function of the built-in flash does not work when the AE lock function is in use.
- The automatic flash function can also be used with the external flash.
- Even if  AUTO is displayed on the LCD panel, the built-in flash does not pop up automatically when the external flash has been mounted either with the power off or the external flash is not yet fully charged.
- If the red-eye reduction is used while the AF360 FGZ, etc. is set as a slave unit, the pre-flash will trigger the slave unit to discharge. Do not use red-eye reduction with slave unit.

RED-EYE REDUCTION FLASH FUNCTION

This camera includes a red-eye reduction flash function, which reduces the red-eye phenomenon utilizing pre-flash. In this mode, the pre-flash is discharged just before the shutter is released which reduces the diameter of the pupil of the eye. Then the main flash is discharged while the pupils are smaller, which in turn reduces the red-eye effect.

ABOUT RED-EYE PHENOMENON

Shooting portraits with flash in a dark environment often causes a subject eyes to turn out reddish in the print. This phenomenon, commonly known as "Red-Eye", is caused by the reflection of the electronic flash in the retina of your subject eye. It can be reduced by taking a picture in a brighter light condition or by shooting with a wider-angle lens at a closer distance, or by employing the red-eye reduction flash feature. When using a Pentax dedicated flash unit off the camera, it may also help to position the flash as far away from the camera as possible.

Flash effective range for the Picture Mode with ISO 100 (400) film used

A lens with a maximum aperture of f/1.4 is marked as 1:1.4 on its barrel.

Maximum Lens Aperture	Effective Range
f/1.4	approx. 0.8 - 3.9m (5.6m) 2.6 - 12.8ft (18.4ft)
f/2	approx. 0.8 - 3.3m (4.8m) 2.6 - 10.8ft (15.7ft)
f/2.8	approx. 0.7-2.8m (4.0m) 2.3-9.2ft (13.1ft)
f/3.5, f/4.7	approx. 0.7 - 2.4m (4.0m) 2.3 - 7.9ft (13.1ft?)
f/5.6	approx. 0.7 - 2.0m (4.0m) 2.3 - 6.6ft (13.1ft?)

MEMO

- This effective range table is only applicable when the exposure mode is set to the Picture Mode. If any other exposure mode is used, see page xx.
- The minimum effective range is always 0.7m (2.6ft) even if a lens with a maximum aperture f/2.8 or smaller is in use. When a subject is shot at a distance less than 0.7m (2.6ft), the correct exposure cannot be obtained, and you will see vignetting in the picture corners.

MANUAL POP UP THE BUILT-IN FLASH

- 1** Push the flash pop-up button to activate the flash.

[FLASH AUTO] will disappear on the LCD panel.

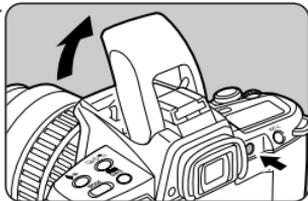

- 2** **[FLASH AUTO]** appears in the viewfinder and on the LCD panel when the flash is fully charged.

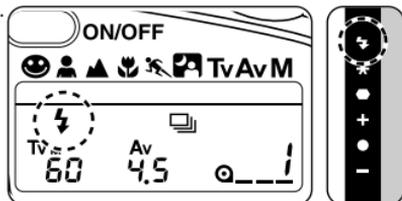

- 3** Depress the shutter release button fully, and the flash unit discharges.



- 4** After using the Built-in flash, push down the flash head to lock it in the closed position.

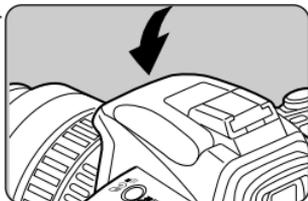

MEMO

- The built-in flash does not pop up even if the flash pop-up button is depressed with the flash mode is set to **[FLASH]**.
 - This mode can be used with the red-eye reduction together.
 - When the flash pop up button is depressed, **[FLASH]** is disappeared from the LCD pane if auto flash mode was set, and the flash is always discharged even if the subject is not required flash light.
 - The shutter cannot be released until the flash is fully charged.
- Download from www.Somanuals.com. All Manuals Search And Download.

- Do not use a lens hood with the built-in flash as it may obstruct the path of the light coming from the flash, causing vignetting in the picture corners.
- With the built-in flash popped up, an external flash cannot be attached to the hot shoe. If you would like to use an external flash together with the built-in flash, see the flash connections on page xx.

FLASH OFF MODE

Use this mode if you don't want the built-in flash to pop-up automatically. The flash will not pop-up automatically even when it is dark nor lights when the flash is required.

1. Depress the Flash mode button until  appears on the LCD panel.

MEMO

- The flash does not discharge even if the built-in flash is in the pop-up position. The flash off mode will work with 6 picture modes.
- The Built-in flash does not pop up automatically or by pushing the Flash pop up button manually.
- In the flash off mode, the external flash will not discharge either.

DAYLIGHT-SYNC SHOOTING

In daylight conditions, when a portrait picture is taken with a person's face cast in shadow, discharging the flash will eliminate the shadow.

1. **Depress the flash pop up button.**
2. **Confirm either the built-in or external flash is fully charged.**
If the background is too bright, it may be over exposed.
3. **Take a picture.**

MEMO

When taking a daylight-sync photograph with  displayed on the LCD panel, the flash may not discharge.



Without Daylight-Sync



With Daylight-Sync

Using other type of a flash

Use of non-Pentax flash units may damage the camera. For the best results, use a Pentax dedicated flash unit.

FLASH RECOMMENDED INDICATOR

The flash recommended indicator  in the viewfinder and on the LCD panel blink slowly to warn and recommend you to use flash when you attempt to take a picture in low light and backlight condition.

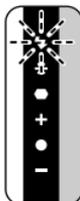
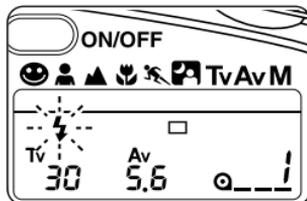

MEMO

In the Shutter-Priority AE Mode and Metered-Manual Mode, the flash recommended indicator blinks only when attempting to photograph a subject in a backlight condition.

INAPPROPRIATE LENS WARNING WHEN THE BUILT-IN FLASH IS USED

When using an inappropriate F or FA lens,  will blink rapidly in the viewfinder and on the LCD panel when the shutter release button is depressed halfway down.

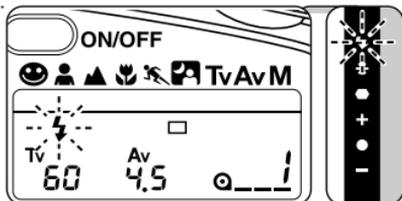

MEMO

- See page xx for more details on compatibility of F and FA lenses with the built-in flash.
- Taking a picture while this warning is appeared may cause vignetting in the picture corners or semi-circular vignetting at the bottom of the picture.

ADVANCED OPERATION FOR THE BUILT-IN FLASH

1. When using one of 6 Picture Modes

- The camera automatically chooses an optimum combination of shutter speed and aperture according to the subject brightness, allowing you to take a flash photograph with ease.
- The shutter speed automatically changes to approximately 1/100 sec. or to a slower speed, which does not cause camera shake. The slowest shutter speed depends on the focal length of the lens fitted to the camera. The slowest shutter speed in the Night-scene Program Mode  is 1 seconds. When the Action program mode is used, the shutter speed is fixed to 1/100 of second.

2. Shutter-Priority AE Mode

- When taking a fast moving subject, you can increase a subject blur effect. The shutter speed can be set slower than 1/100 of second.
- In this mode, the aperture automatically changes according to the ambient brightness, making a flash photograph easily.

3. Aperture-Priority AE mode

- In this mode, the shutter speed automatically changes with the ambient brightness. The shutter speed changes in range of 1/100 sec. to a slower shutter speed that does not cause camera shake. The slowest shutter speed depends on the focal length of the lens in use. The shutter speed of 1/100 sec. is set automatically with a Pentax A lens.

4. Metered Manual Mode

- When using the built-in flash in the Metered Manual Mode, any combination of aperture and shutter speed slower than 1/100 can be set. In this mode, the exposure of the background can be controlled by the manual exposure while the flash properly exposes the foreground subject.

1. Calculating the flash effective range according to the camera-to-subject distance.

Maximum flash distance = Guide Number \div Selected aperture

Minimum flash distance = Maximum flash distance \div 5*



MEMO

- When the distance to the subject is less than 0.7m (2.3ft), the flash cannot be used. If the flash is used less than 0.7m, it causes vignetting in the picture corners, light is distributed unevenly and the picture may be over exposed.
- *The value 5 used in the formula above is fixed value applied to the built-in flash in this camera.

The guide number (GN) depends upon the film speed used as shown below.

ISO25→GN5.5	ISO200→GN15.6
ISO50→GN7.8	ISO400→GN22
ISO100→GN11	

Exp. If an ISO100 film is used at an aperture of f/3.5, the flash effective distance is obtained as follows:

For maximum distance Guide Number (11) \div f/3.5 = 3.14m

For minimum distance 3.14 \div 5 = 0.63m \rightarrow 0.7m *

* Minimum distance of the built-in flash in this camera

Thus, the flash effective distance is from approx. 0.7m to 3.14m.

2. Calculating the aperture according to the camera-to-subject distance

$$\text{Aperture} = \text{Guide Number} \div \text{Camera-to-subject distance}$$

If the calculated aperture value is different than an indicated f-stop, for instance f/3, choose the next smaller aperture value. (f/2.8 in this case).

COMPATIBILITY OF F AND FA LENSES WITH THE BUILT-IN FLASH

If an F or FA lens incompatible with the built-in flash is used, depressing the shutter release button halfway down when the flash is ready, () blink in the viewfinder and on the LCD panel as a warning.

If the flash picture is taken with an incompatible lens, the corner of the picture may look ark or there may be dark, semi-circular area on the lower part of the picture.

○ = compatible △ = Vignetting will occur under the usage conditions

× = incompatible because of vignetting]

Lens Name	Compatibility
F, Fish-Eye Zoom 17-28mm f/3.5-4.5	×
FA Zoom20-35mm f/4	△ Vignetting will occur at focal length is less than 28mm.
FA Zoom 24-90mm f/3.5-4.5AL(IF)	△ Vignetting will occur at focal length between 24-28mm.
FA* Zoom 28-70mm f/2.8AL	×
FA Zoom 28-70mm f/4 AL	○
FA Zoom28-80mmf/3.5-5.6	△ Vignetting will occur at focal length between 28-35mm or the camera to subject distance is less than 1m with the focal length of 35mm.
FA Zoom 28-90mm f/3.5-5.6	○
FA Zoom 28-105mm f/3.2-5.6	○
FA Zoom 28-105mm f/4-5.6 (IF)	△ Vignetting will occur at focal length is less than40mm.
FA Zoom 28-200mm f/3.8-5.6	△ Vignetting will occur at focal length is less than 70mm.
F or FA35-80mm f/4-5.6	○

Lens Name	Compatibility
FA Zoom 70-200mm f/4-5.6	○
FA* Zoom 80-200mm f/2.8	△ Vignetting will occur at focal length is less than 90mm.
F or FA Zoom 80-200mm f/4.7-5.6	○
FA Zoom 80-320mm f/4.5-5.6	○
F or FA Zoom 100-300mm f/4.5-5.6	○
FA Zoom 100-300mm f/4.7-5.6	○
FA*Zoom 250-600mmf/5.6ED(IF)	×
FA20mmf/2.8	×
FA24mmf/2AL(IF)	×
FA28mmf/2.8	○
FA31mmf/1.8AL Limited	○
FA35mmf/2AL	○
FA43mmf/1.9 Limited	○
FA50mmf/1.4,f/1.7	○
FA77mmf/1.8	○
FA*85mmf/1.4	○
FA*135mm	○
FA*200mm	○
FA*300mmf/2.8	×
FA*300mmf/4.5	○
FA*400mmf/5.6	○
FA* 600mmf/4ED (IF)	×
FA MACRO 50mm f/2.8	○
FA MACRO 100mm f/2.8, f/3.5	○
FA MACRO 200mm f/4.0 ED (IF)	○
FA Soft 28mm f/2.8	○
FA Soft 85mm f/2.8	○

OVERVIEW OF FLASH FUNCTION

CAMERA FUNCTION	A	B	C	D	E
Red-eye reduction flash function	○	○	×	○ ^{*1}	×
Smart flash function operates	○	○	○	○	○
After the flash is charged, the camera automatically switches to the flash-sync speed.	○	○	○	○	○
Automatic aperture setting in the Picture Mode or Shutter-Priority AE Mode	○	○	○	○ ^{*2}	○ ^{*2}
Flash confirmation in the viewfinder	×	○	○	×	×
TTL auto flash	○	○ ^{*4}	○	○ ^{*3}	×
Slow-shutter sync flash	○	○	○	○	○
AF illuminator	×	○	○	×	×
Trailing-shutter-curtain sync flash *4	○ ^{*5}	○	○	×	×
Contrast-control-sync flash mode *4	×	○	×	×	×
Multiple burst flash, slave flash	×	○ ^{*6}	×	×	×

A: Built-in flash

B: AF360FGZ, AF500FTZ, AF330FT

C: AF400FTZ, AF240FTZ

D: AF400T, AF280T, AF220T, AF200T, AF080C, AF140C,
AF201SA, AF200SA

E: AF200S, AF160, AF140,

 **MEMO**

- *1. When using the AF280T or AF400T with the flash confirmation OFF and TTL mode, the red-eye reduction function operates.
- *2. When using a type D flash (except AF200SA and AF201SA) in the MS (Manual Sync) or M (Manual) Mode or when using a Type E flash, set the camera exposure mode to the Aperture-Priority AE Mode, Metered Manual or Bulb timer Mode. Picture mode and Shutter –priority AE cannot be used because the actual required aperture value may change.
- *3. With the AF201SA and AF200SA, TTL auto cannot be used.
- *4. The shutter speed is 1/60 of second or slower.
- *5. With TYPE B or C and D flash units, trailing-shutter-curtain sync flash is possible.
- *6. Except AF360FGZ and AF330FTZ.

USING PENTAX DEDICATED AUTO FLASH UNITS

If the built-in flash is not powerful enough, a Pentax dedicated auto flash should be used.

A Pentax dedicated TTL Auto Flash like the PENTAX AF FTZ or AF FT series flash unit (i.e.: AF500FTZ, AF330, AF280T or AF220T) incorporate the TTL Flash Mode.

Using the TTL Auto Flash Mode

1. Remove the hot shoe cover FK.

Store the removed hot shoe cover in the strap pocket.

2. Attach a Pentax dedicated flash unit to the camera.

3. Turn the flash ON.

4. Set the flash mode to the TTL Auto Mode.

5. Confirm that the flash is fully charged.

6. Focus on the subject and depress the shutter release button to take a picture.

MEMO

- When the flash is fully charged, the ready lamp on the flash unit lights up. When the shutter release button is depressed halfway down, [] appears in the viewfinder indicating the flash is ready.
- An external flash can also be made to automatically fire. Note that the flash will not fire against a lighter subject especially during daytime synchro shooting.
- Read the operating manual of the flash unit for more details.

Using both the built-in flash and the external flash

An external flash cannot be used when the built-in flash is in its popped up position. When the built-in flash and the external flash are used simultaneously, use the following optional accessories.

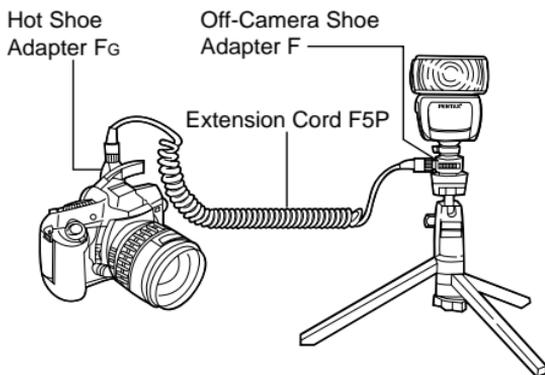

- 1. Remove the hot shoe cover FK from the camera.**
Store the removed hot shoe cover in the strap pocket.
- 2. Attach the hot shoe adapter FG to the camera.**
- 3. Connect the extension cord F5P to the hot shoe adapter FG**
Turn the flash ON.
- 4. Attach the Off-Camera shoe adapter F to a tripod** Set the flash mode to the TTL Auto Mode.
- 5. Attach the flash unit to the Off-camera shoe adapter F**
Connect the extension cord F5P to the off –camera shoe adapter F.
- 6. Depress the flash pop up button to activate the built-in flash**
- 7. Confirm that the all flash units are fully charged.**
- 8. Focus on the subject and depress the shutter release button to take a picture.**

OVERVIEW OF FLASH FUNCTION

- The AF500FtZ can be connected directly to the Extension cord F5P without Off-camera shoe adapter.
- The AF400T flash cannot be used with the built-in flash simultaneously because the 4P sync cord B from the AF400T will interrupt the function of the built-in flash.

Red-eye reduction flash function

The red-eye reduction flash function with an external flash attached can also be used depending on what type of an external flash is attached, and it may have any restrictions for usage. See page 70 for more details. The red-eye reduction flash function can be used only when the external flash is set to the TTL Auto Mode.

Trailing-Shutter-Curtain Flash function

When using the built-in flash and the external flash simultaneously, the trailing-shutter-curtain-flash function for the built-in flash also operates when the external flash is set to the trailing-shutter-curtain flash function. Before shooting, confirm that both flash units are fully charged.

Multi-burst flash with the Pentax dedicated flash

When discharging more than 2 Pentax dedicated flashes, make sure that they are of the same type, combine the type B with Type C or Type D with Type E. Refer to the overview of Flash Function on page 70. The built-in flash can be operated with any type of Pentax TTL dedicated flash unit. 2.

Contrast-Control-Synch Flash Photography

Using the dedicated external flash in combination with the built-in flash allows twin flash photography (contrast-control-synch flash photography). This is based on the difference between the amounts of light discharged from two units.

Contrast control synch flash is possible with the combination of following flash units:

AF360FGZ, AF330FTZ, AF500FTZ and the built-in flash

- 1. Place the flash unit a part from the camera.**
- 2. Depress the flash pop up button to activate the built-in flash.**
- 3. Set the flash synch mode to the Contrast-Control-Synch mode.**
- 2. Ensure that both flash units are fully charged and then depress the shutter button to take a picture.**

MEMO

- The ratio of the amount of flashlight is 1 (built-in flash): 2 (dedicated flash unit).
- Do not combine an accessory with a different number of contacts such as a "Hot Shoe Grip" as a malfunction may occur.
- In the Contrast-Control-Synch Flash Mode, the faster flash sync speed is 1/60 of second.

SLOW-SPEED-SYNC SHOOTING

It is possible to balance the exposure of a foreground subject against a dimly light background by using the flash to properly expose the foreground subject and a slow-shutter-speed to expose the low light background.

With the Night-scene Program Mode

- 1. Set the lens aperture ring to \boxed{A} .**
- 2. Set the pointer mark to () by moving the select dial while depressing the exposure mode button.**
- 3. The built-in flash pops up automatically.**
- 4. Before shooting, confirm that the flash is fully charged.**

In this mode, the shutter speed automatically changes with ambient brightness. The shutter speed changes in the range from 1/100 sec. to 1 second.

When the flash does not pop up in the step 3, push the flash pop-up button to activate the flash.

With the Metered Manual Mode

- 1. Depress the flash pop-up button to activate the built-in flash.**
- 2. Set the Exposure mode to the Metered Manual Mode.**
- 3. Select an appropriate shutter speed (slower than 1/100 of second) and aperture combination for a correct exposure on the LCD panel.**
- 4. Before shooting, confirm that the flash is fully charged.**



MEMO

- The slow-speed-sync can also be used with the Shutter-Priority AE Mode set. Confirm that the exposure is not appearing in the viewfinder.
- In the slow-shutter-sync shooting, use of a tripod is recommended to prevent camera shake.

4

OTHERS

ACCESSORIES (OPTIONAL)XX
TROUBLESHOOTINGXX
PROGRAM LINESXX
STANDARD PROGRAM MODE	
NIGHT-SCENE PROGRAM MODE WITHOUT FLASH	
PORTRAIT PROGRAM MODE	
LANDSCAPE PROGRAM MODE	
CLOSE-UP PROGRAM MODE	
ACTION PROGRAM MODE	
SPECIFICATIONSXX
WARRANTY POLICYXX

ACCESSORIES (OPTIONAL)

A number of dedicated accessories are available for this camera.

AA-BATTERY PACK FG

Battery grip powered by size –AA batteries and dedicated to MZ-60.

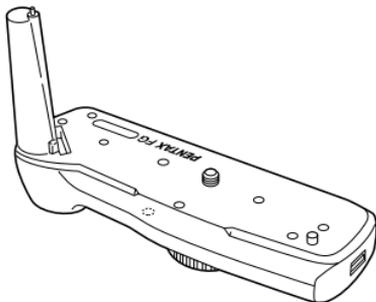

MEMO

Battery life (Using 24-Exposure film rolls)

	Number of film rolls at 20°C(68°F)
General existing light photography	approximately 180 rolls
Flash photography using flash 50% of the times	approximately 35 rolls
Flash photography using flash 100% of the times	approximately 20 rolls

FLASH ACCESSORIES

AF360FGZ

A TTL auto zoom flash unit with guide no. 36(ISO 100). It features include AF spot beam, slave-synch flash, multiple-flash, contrast-control-synch flash and leading /trailing curtain –synch mode.

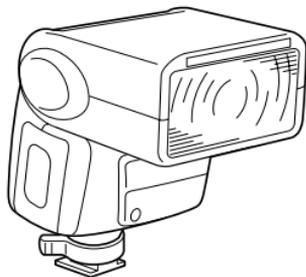

AF500 FTZ

A TTL Auto Zoom flash with a built-in AF spot beam and large guide no. 50 (ISO 100). It features the slave-synch flash function, multiple-flash, contrast-control-synch flash, and leading/trailing-curtain-synch flash mode.

AF220T

A TTL Auto flash with a guide number of 22 ISO 100).

AF201SA

An Auto flash (Not TTL) with a guide number of 20 (ISO 100).

Macro Flash AF140C

A TTL macro flash unit with the guide numbers 14 (ISO 100).

Off-Camera shoe Clip CL-10

Enable the AF360FGZ to be used as a wireless slave flash.

ACCESSORIES (OPTIONAL)

Hot Shoe Adapter F, Extension Cord F5F and Off-Camera –shoe Adapter

The adapters and cords, which allow the external flash to be used off the camera, while maintaining full electric coupling to the camera.

VIEWFINDER AND LENS ACCESSORIES

Magnifier FB

A viewfinder accessory for magnifying the central area of the viewfinder.

Refconverter A

Right angle finder, which attaches to the grooves on both sides of the viewfinder. The viewfinder magnification is able to switch from 1X to 2X.

Filters

Skylight, UV, Cloudy, Y2, O2, R2, and Circular Polarizing Filter are available in sizes of 49mm, 52mm, 58mm, 67mm and 77mm.

Diopter correction lens adapter M

Diopter correction lenses that slide into the eyepiece groove on the camera are available.

If you find it difficult to see the viewfinder image clearly, choose one of the eight correction lenses M of -5, -4, -3, -2, -1, +1, +2, +3 m

Notes on accessories

The camera does not operate when a lens with the following conditions attached.

1. When a lens, which does not have the A, position on the aperture ring is attached.
2. When an F, FA or A lens is attached with the aperture ring set other than the A position.
3. F or FA 85mm f/2.8 Soft lens and FA28mm f/2.8 Soft lens cannot be used because these lenses do not have the A position on the lens aperture ring.

The camera does not operate with the following accessories used.

Accessories for close-up photography

Auto extension tube set K
Auto extension tube K 50mm
Auto extension tube K 100mm
Helicoid extension tube K
Auto bellows-A
49mm and 52mm Reverse adapter K
Extension tube K
Microscope adapter K

Mount adapters

Adapter K for 645 lens
67 lens adapter K

- when the refconverter A is used, it may interfere with the camera when you open or close the back cover. Remove the refconverter A before opening or closing the back cover.
- when the special effect filter or "Magic Image Attachment" or "Stereo Adapter" is used, the auto focusing and manual focusing with the in-focus indicator in the viewfinder do not operate. Use the manual focus mode to focus on the subject with the aid of the matte field surrounding the autofocus frame.

Using a Polarizing Filter

When using an ordinary polarizing filter; the half mirror incorporated into the autofocus system reduces the effectiveness of the autofocus function when used in combination with an ordinary polarizing filter. Use a CIRCULAR POLARIZING FILTER for proper autofocus operation.

Download from [Www.Somanuals.com](http://www.Somanuals.com). All Manuals Search And Download.

TROUBLESHOOTING

What appears troublesome may be easily remedied. Here are some problems that may occur and their remedies. Before contacting a Pentax service center, check the following items.

Symptoms	Causes	Remedies	Reference
The shutter does not release	The lens aperture ring is set to other than the [A] position.	Set the lens aperture ring to the [A] position.	P.24, P.48
	The main switch is [OFF].	Turn the main switch ON.	P.16
	The low battery warning  is blinking.	Replace the battery.	P.12
	The batteries are installed bakwards.	Install the batteries properly.	P.12
	[ISO] is displayed on the LCD panel.	Set the exposure mode to other position.	P56, P64
	The built-in flash is being charged.	Wait until the flash is fully charged.	P.34
Nothing is displayed on the LCD panel.	The main switch is [OFF].	Turn the main switch ON.	P.16
	No battery has been installed.	Install the batteries.	P.12
	The batteries are installed backwards.	Install the batteries properly.	P.12
	The battery is dead.	Replace the batteries.	P.12
The Autofocus does not work.	AF frame is not placed over the subject.	Move the camera until the AF frame  covers the subject.	P.30
	The subject is too close.	Increase the camera-to-subject distance.	P.30
	The focus mode is set to [MF] .	Set the focus mode switch to [AF] .	P.27
	The subject is difficult to autofocus.	Focus manually by using the matte field.	P.60

Symptoms	Causes	Remedies	Reference
AE lock function do not operate.	The Metered Manual Mode or Bulb Exposure Mode is being used.	Set the exposure mode dial to the other position.	P.57
Focus indicator  in the viewfinder blinks.	The subject is too close or difficult to autofocus.	Focus manually by using the matte field.	P.60
The built-in flash does not charge.	Low battery warning  on the LCD panel blinking.	Replace the batteries.	P.12
The built-in flash does not activate when the flash-pop up button is depressed.	The exposure mode is being set to  .	Set the mode dial other than  .	P.26
The built-in flash does not pop up automatically.	The mode dial is set to other than the Picture Mode.	Set the exposure mode dial to the Picture Mode.	
	Flash mode is not set to Auto pop up mode().	Set the flash mode dial to () or ().	
The built-in flash does not discharge even if the flash is in the popped-up position.	When the  AUTO appears on the LCD panel, the built-in flash does not discharge in bright lighting conditions.		
The power zoom system does not function.	The camera does not have the power zoom function.		

In rare cases, the camera may not operate correctly due to statistic electricity. This can be remedied by taking the batteries out and putting them back in again.

PROGRAM LINE

Standard program Mode / Night Scene Program Mode without Flash

At ISO 100 with FA35 - 80mm f/4 - 5.6 lens

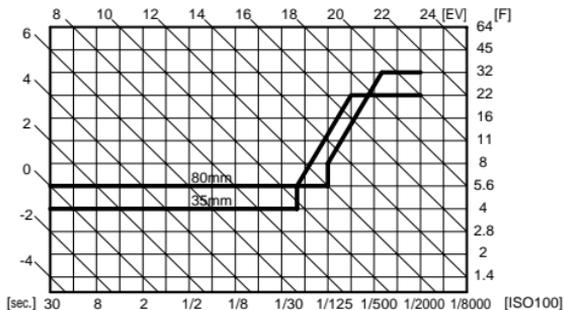

Portrait Program Mode At ISO with FA35 - 80mm f/4 - 5.6 lens

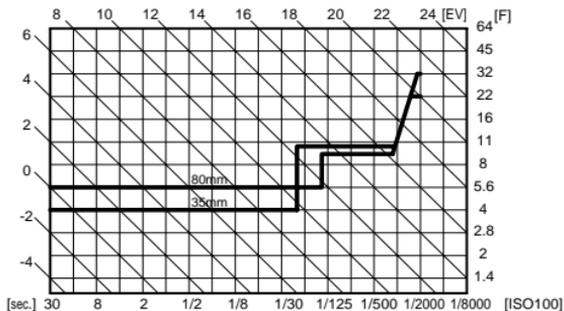

Landscape Program Mode At ISO 100 with FA35 - 80mm f/4 - 5.6 lens

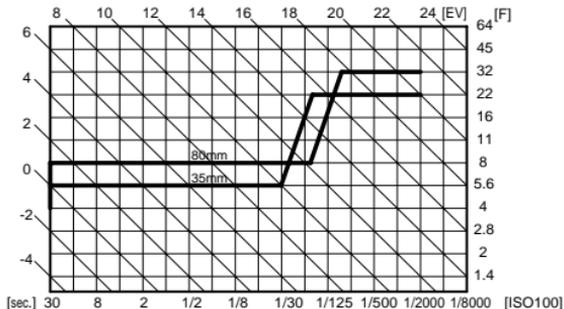

Action Program Mode At ISO 100 with FA35 - 80mm f/4 - 5.6 lens

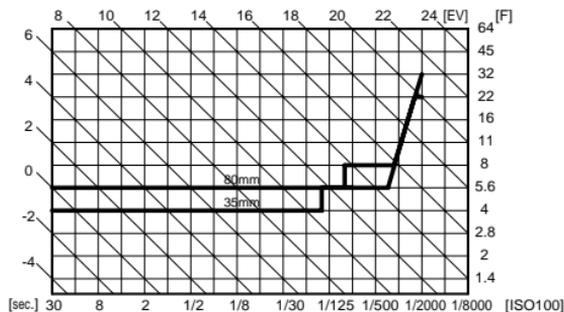

Close-up Program Mode At ISO 100 with FA35 - 80mm f/4 - 5.6 lens

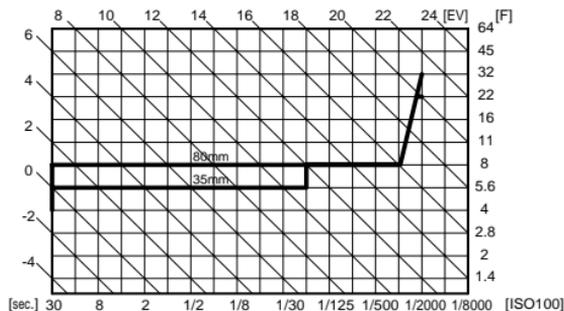

SPECIFICATIONS

- Type** ———— TTL autofocus, auto-exposure 35mm SLR with built-in TTL auto flash (RTF)
- Format** ———— 24x36mm
- Usable Film** ——— 35mm perforated cartridge film. DX-coded film with ISO 25-5000; non-DX coded films with ISO 6-6400
- Exposure Modes** - Picture Mode (Standard program Mode, Portrait Program Mode, Landscape Program Mode, Close-up Program Mode, Action Program Mode, Night-scene Program Mode), Shutter-Priority AE Mode, Aperture-Priority AE Mode, Metered Manual Mode, Bulb Exposure Mode, TTL Flash Mode
- Shutter** ———— Electronically controlled vertical-run focal-plane shutter, Electromagnetic release,
- Speed range** ——— (1) Auto 1/2000-30 sec. (step less), (2) Manual 1/2000-30 sec. (3) Bulb timer 45sec.-32min.
Shutter lock by setting Main switch in OFF position.
- Body Mount** ——— Pentax KAF bayonet mount (K-mount with AF coupler, lens information contacts)
- Compatible Lens** - Pentax KAF2-, KAF- and KA-mount lenses.
- Autofocus System** - TTL phase-matching autofocus system, AF operational brightness range: EV 0 to 18 (at ISO 100 with f/1.4 lens), Focus lock available using shutter release button, Focus Mode:  (predictive AF provided), Manual 
- Viewfinder** ——— Penta-mirror finder, Natural-Bright-Matte focusing screen, Field of view: 90%,
- Magnification** ——— 0.77X(with 50mm f/1.4 lens at ∞), Autofocus frame, Diopter : -1m⁻¹
- Viewfinder Indication** ——— Focus Information: In-focus (Green lamp  is lit), front or back focus signals and unable-to-focus indicator (Green lamp blinks), Flash ready indication  is lit, Over  or Under  or correct exposure  indication in Metered Manual Mode, , ,  AE lock indicator

External LCD

panel Indication — Shutter speed, Aperture value,  = Built-in flash ready indication,  = blinking slowly flash recommended warning,  = blinks rapidly Inappropriate lens warning,  = Red-eye reduction flash function,  = Auto-popup flash function, Automatic flash function, ISO indication,  = Film status information,  = Battery exhaustion warning, Exposure counter,  = Auto bracketing exposure,  = Auto bracketing compensation value,  = Exposure counter,  = Self-timer,  = Consecutive shooting,  = AE Lock

Self-timer — Electronically-controlled with delay time of 12 sec. or 2 sec. with mirror lock up in used, Cancelable after operation

Mirror — Instant-return mirror with AF secondary mirror

Film Loading — Film advances automatically to 1st frame after back cover is closed, Film information window is provided

Film Wind &

Rewind — Auto wind/rewind by built-in motor, Consecutive or Single advance mode, Approx. 1 frames/sec. (consecutive mode), Auto rewinding starts at end of roll, Film rewind/completion of rewinding is displayed on the LCD panel, Mid-roll rewind

Exposure Meter — TTL 2-segment metering, Metering range from EV4 to EV21 at ISO100 with 50mm f/1.4 lens

AE lock — Exposure is memorized for 20 seconds

Flash — Series-control, Auto-popup TTL Auto Flash (RTF), Guide number: 11 (ISO100/m), Illumination angle covers 28mm lens angle of view, Flash-sync-shutter in the range from 1/100 sec. to a slower speed, Day-light-sync flash, Slow-shutter-sync flash, Contrast-control-sync flash (ISO range = 25 – 800), Automatic flash function, Red-eye reduction flash function

Flash sync — Hot shoe with X-contact which couples with Pentax dedicated auto flashes, ISO range = 25-800, Red-eye reduction flash function

Power Source — Two 3V lithium batteries (CR2 or equivalent)

Battery Exhaustion

Warning — Battery exhaustion symbol  is lit (the shutter is locked when blinking; no indication in the viewfinder.)

Dimension and

Weight — 136mm(W) x94.5mm (H) x63mm (D) (5.4"x3.7"x2.5") 325g(11.5 oz) body only without batteries

SPECIFICATIONS ARE SUBJECT TO CHANGE AT ANY TIME WITHOUT NOTIFICATION OR ANY OBLIGATION ON THE PART OF THE MANUFACTURER.

Download from www.Somanuals.com. All Manuals Search And Download.

WARRANTY POLICY

All Pentax cameras purchased through authorized bona fide photographic distribution channels are guaranteed against defects of material or workmanship for a period of twelve months from date of purchase. Service will be rendered, and defective parts will be replaced without cost to you within that period, provided the equipment does not show evidence of impact, sand or liquid damage, mishandling, tampering, battery or chemical corrosion, operation contrary to operating instructions, or modification by an unauthorized repair shop. The manufacturer or its authorized representatives shall not be liable for any repair or alterations except those made with its written consent and shall not be liable for damages from delay or loss of use or from other indirect or consequential damages of any kind, whether caused by defective material or workmanship or otherwise; and it is expressly agreed that the liability of the manufacturer or its representatives under all guarantees or warranties, whether expressed or implied, is strictly limited to the replacement of parts as hereinbefore provided. No refunds will be made on repairs by non-authorized Pentax service facilities.

Procedure During 12-month Warranty Period

Any Pentax which proves defective during the 12-month warranty period should be returned to the dealer from whom you purchased the equipment or to the manufacturer. If there is no representative of the manufacturer in your country, send the equipment to the manufacturer, with postage prepaid. In this case, it will take a considerable length of time before the equipment can be returned to you owing to the complicated customs procedures required. If the equipment is covered by warranty, repairs will be made and parts replaced free of charge, and the equipment will be returned to you upon completion of servicing. If the equipment is not covered by warranty, regular charges of the manufacturer or of its representatives will apply. Shipping charges are to be borne by the owner. If your Pentax was purchased outside of the country where you wish to have it serviced during the warranty period, the manufacturer's representatives in that country may charge regular handling and servicing fees. Notwithstanding this, your Pentax returned to

the manufacturer will be serviced free of charge according to this procedure and warranty policy.

In any case, however, shipping charges and customs clearance fees to be borne by the sender. To prove the date of your purchase when required, please keep the receipt or bills covering the purchase of your equipment for at least a year. Before sending your equipment for servicing, please make sure that you are sending it to the manufacturer's authorized representatives or their approved repair shops, unless you are sending it directly to the manufacturer. Always obtain a quotation for the service charge, and only after you accept the quoted service charge, instruct the service station to proceed with the servicing.

The local warranty policies available from Pentax distributors in some countries can supersede this warranty policy. Therefore, we recommend that you review the warranty card supplied with your product at the time of purchase, or contact the PENTAX distributor in your country for more information and to receive a copy of the warranty policy.

For customers in U.S.A.

STATEMENT OF FCC COMPLIANCE

This device complies with Part 15 of the FCC Rules. Operation is subject to the following two conditions: (1) This device may not cause harmful interference, and (2) this device must accept any interference received, including interference that may cause undesired operation.

Changes or modifications not approved by the party responsible for compliance could void the user's authority to operate the equipment. This equipment has been tested and found comply with the limits for a Class B digital device, pursuant to part 15 of the FCC Rules. These limits are designed to provide reasonable protection against harmful interference in a residential installation. This equipment generates, uses and can radiate frequency energy and, if not installed and used in accordance with the instructions, may cause harmful interference to radio communications. However, there is no guarantee that interference will occur in a particular installation. If this equipment does not cause harmful interference to radio or television reception, which can be determined by turning the equipment off and on, the user is encouraged to try to correct the interference by one or more of the following measures:

- Reorient or relocate the receiving antenna Increase the separation between the equipment and receiver.
- Consult the dealer or an experienced radio/TV technician for help.

For customers in Canada

This Class B digital apparatus meets all requirements of the Canadian Interference - Causing Equipment Regulations.



Asahi Optical Co., Ltd. 2-36-9, Maeno-cho, Itabashi-ku, Tokyo 174-8639, JAPAN

(<http://www.pentax.co.jp/>)

Pentax GmbH (European Headquarters) Julius-Vosseler-Strasse, 104, 22527 Hamburg, GERMANY

(HQ - <http://www.pentaxeurope.com> Germany - <http://www.pentax.de>)

Pentax U.K. Limited Pentax House, Heron drive, Langley, Slough, Berks SL3 8PN, U.K.

(<http://www.pentax.co.uk>)

Pentax France S.A. 12/14, rue Jean Poulmarch, 95106 Argenteuil Cedex, FRANCE

Pentax Benelux B.V. (for Netherlands) Spinveld 25, 4815 HR Breda, NETHERLANDS

(<http://www.pentax.nl>) (for Belgium & Luxembourg) Weiveldlaan 3-5, 1930

Zaventem, BELGIUM (<http://www.pentax.be>)

Pentax (Schweiz) AG Widenholzstrasse 1 Postfach 367 8305 Dietlikon, SWITZERLAND

(<http://www.pentax.ch>)

Pentax Scandinavia AB P.O. Box 650, 75127 Uppsala, SWEDEN (<http://www.pentax.se>)

Pentax Europe n.v. (European Distribution Center) Weiveldlaan 3-5, 1930 Zaventem, BELGIUM

Pentax Corporation 35 Inverness Drive East, Englewood, Colorado 80112, U.S.A.

(<http://www.pentax.com>)

Pentax Canada Inc. 3131 Universal Drive, Mississauga, Ontario L4X 2E5, CANADA

(<http://www.pentaxcanada.ca>)



The CE marking assures that this product complies with the requirements of the EC directive for safety.

This operating manual is printed on recycled paper.

Free Manuals Download Website

<http://myh66.com>

<http://usermanuals.us>

<http://www.somanuals.com>

<http://www.4manuals.cc>

<http://www.manual-lib.com>

<http://www.404manual.com>

<http://www.luxmanual.com>

<http://aubethermostatmanual.com>

Golf course search by state

<http://golfingnear.com>

Email search by domain

<http://emailbydomain.com>

Auto manuals search

<http://auto.somanuals.com>

TV manuals search

<http://tv.somanuals.com>