

PENTAX

EN

Digital Camera

Optio E90

Operating Manual

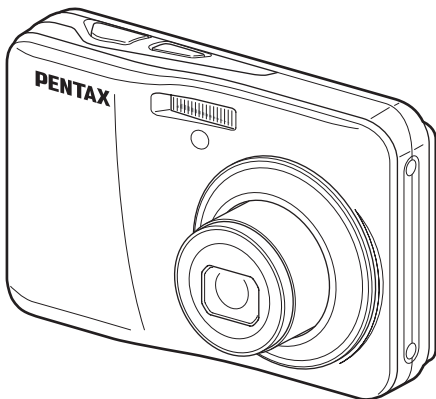

To ensure the best performance from your camera, please read the Operating Manual before using the camera.

Thank you for purchasing this PENTAX Digital Camera.

Please read this manual before using the camera in order to get the most out of all the features and functions. Keep this manual safe, as it can be a valuable tool in helping you to understand all the camera capabilities.

Regarding copyrights

Images taken using the PENTAX Digital Camera that are for anything other than personal enjoyment cannot be used without permission according to the rights as specified in the Copyright Act. Please take care, as there are cases where limitations are placed on taking pictures even for personal enjoyment during demonstrations, performances or of items on display. Images taken with the purpose of obtaining copyrights also cannot be used outside the scope of use of the copyright as laid out in the Copyright Act, and care should be taken here also.

Regarding trademarks

PENTAX and Optio are trademarks of HOYA CORPORATION.



SDHC Logo is a trademark of SD-3C, LLC.

This product supports PRINT Image Matching III. PRINT Image Matching enabled digital still cameras, printers and software help photographers to produce images more faithful to their intentions. Some functions are not available on printers that are not PRINT Image Matching III compliant.

Copyright 2001 Seiko Epson Corporation. All Rights Reserved.

PRINT Image Matching is a trademark of Seiko Epson Corporation. The PRINT Image Matching logo is a trademark of Seiko Epson Corporation.

All other brands or product names are trademarks or registered trademarks of their respective companies.

ArcSoft[®], and its logo are either the registered trademark or trademark of ArcSoft Inc. in the United States and/or other countries.

Microsoft and Windows are registered trademarks of Microsoft Corporation in the United States and other countries.

Windows Vista is either a registered trademark or trademark of Microsoft Corporation in the United States and/or other countries.

Macintosh and Mac OS are trademarks of Apple Inc., registered in the U.S. and other countries.

Regarding Product Registration

In order to serve you better, we request that you complete the product registration, which can be found on the CD-ROM supplied with the camera or the PENTAX website. Thank you for your cooperation.

Refer to chapter 7 for more information.

There is a possibility that the illustrations and the display screen in this manual are different from the actual product.

In this manual, both an SD Memory Card and an SDHC Memory Card are referred to as SD Memory Cards hereafter.

In this manual, the generic term "computer(s)" refers to either a Windows PC or a Macintosh hereafter.

To users of this camera

- Do not use or store this device in the vicinity of equipment that generates strong electromagnetic radiation or magnetic fields.
Strong static charges or the magnetic fields produced by equipment such as radio transmitters could interfere with the monitor, damage the stored data, or affect the product's internal circuitry and cause camera misoperation.
- The liquid crystal panel used in the display is manufactured using extremely high precision technology. Although the level of functioning pixels is 99.99% or better, you should be aware that 0.01% or fewer of the pixels may not illuminate or may illuminate when they should not. However, this has no effect on the recorded image.
- If you point the camera toward an object that is bright, a band of light may appear on the LCD screen. This phenomenon is referred to as "smear" and is not a malfunction of the camera.
- In this manual, the term "battery" refers to any type of batteries used for this camera and accessories.

USING YOUR CAMERA SAFELY

We have paid close attention to the safety of this product. When using this product, we request your special attention regarding items marked with the following symbols.



Warning This symbol indicates that violating this item could cause serious personal injuries.



Caution This symbol indicates that violating this item could cause minor or medium personal injuries, or material losses.

About the Camera



Warning

- Do not attempt to take the camera apart or remodel the camera. High voltages are present within the camera, and there is therefore a danger of electric shocks if the camera is taken apart.
- If the inside of the camera should become exposed as a result of, for example, the camera being dropped, please do not under any circumstances touch such exposed portions, as there is a danger of receiving an electric shock.
- Wrapping the strap of the camera around your neck is also dangerous. Please take care that small children do not hang the strap around their necks.

- If the camera emits smoke or a strange smell, or in the event of any other irregularity, stop using the camera immediately, remove the batteries and contact your nearest PENTAX Service Center. Continued use of the camera may result in fire or electric shock.
- Do not place your finger over the flash when discharging the flash. You may burn yourself.
- Do not discharge the flash while it is touching your clothing as there is a risk of discoloring.
- Some portions of the camera heat up during use, so please take care, as there is a risk of low temperature burns if such portions are held for long periods of time.
- Should the LCD be damaged, be careful of glass fragments. Also, be careful not to allow the liquid crystal to get on your skin or in your eyes or in your mouth.
- Depending on your inherent factors or physical condition, the use of the camera may cause itching, rashes or blisters. In case of any abnormality, stop using the camera and get medical attention immediately.

About the Batteries

Warning

- Be sure to store the battery out of the reach of small children. Placing it in their mouths may cause an electric shock.
- If any leakage from the batteries should come in contact with your eyes, it may cause a loss of sight. Flush your eyes with clean water and get medical attention immediately. Do not rub them.

Caution

- This camera uses two AA alkaline, AA lithium or AA Ni-MH batteries. Do not use batteries other than those specified here. Using some other type of battery may cause the camera to function poorly, or the batteries may explode or cause a fire.
- AA alkaline and AA lithium batteries cannot be recharged. Do not try to take the batteries apart. The batteries may explode or leak if you try to charge them or take them apart.
- Do not insert the batteries with the positive (+) and negative (-) poles in the wrong orientation. Doing so may cause the batteries to explode or cause a fire.
- When replacing the batteries, do not combine different brands, types or capacities. Also, do not combine old batteries with new ones. Doing so may cause the batteries to explode or cause a fire.
- Never try to disassemble or short the batteries. Also, do not dispose of the batteries in a fire, as they may explode.

- Do not charge any batteries other than rechargeable Ni-MH batteries. The batteries could explode or catch fire. Batteries for use with this camera other than Ni-MH batteries cannot be charged.
- If any leakage from the batteries should come in contact with skin or clothes, wash the affected areas thoroughly with water.
- Remove the batteries from the camera immediately if they become hot or begin to smoke. Be careful not to burn yourself during removal.

Keep the Camera and Accessories Out of the Reach of Small Children

Warning

- Be sure to keep the camera and its accessories out of the reach of small children.
 1. Injuries may result from the product falling or from unexpected movement.
 2. Suffocation may result from wrapping the strap around the neck.
 3. Small accessories such as batteries or an SD Memory Card may be swallowed. Seek medical attention immediately if an accessory is accidentally swallowed.

About the AC Adapter

Warning

- Use an AC adapter that is of the power and voltage specified for exclusive use with this product. The use of an AC adapter other than that specified exclusively for use with this product may cause fire or electric shocks. The specified voltage is 100 -240V AC.
- Do not disassemble or modify the product. This can cause a fire or electric shock.
- If the generation of smoke or strange odor from the product or other abnormality occurs, immediately discontinue use and consult a PENTAX Service Center. Continuing to use the product can cause a fire or electric shock.
- If water should happen to get inside the product, consult a PENTAX Service Center. Continuing to use the product can cause a fire or electric shock.
- If a thunder storm should occur while using the battery charger, unplug the AC plug cord and discontinue use. Continuing to use the product can cause damage to the equipment, fire, or electric shock.
- Wipe off the plug of the AC plug cord if it becomes covered with dust. Dust on the plug may cause a fire.

Caution

- Do not place heavy objects on the AC plug cord, allow heavy objects to drop onto it or allow the AC plug cord to become damaged due to excessive bending. If the AC plug cord becomes damaged, consult a PENTAX Service Center.
- Do not short or touch the output terminals of the product while it is still plugged in.
- Do not plug in the AC plug cord with wet hands. This can cause an electrical shock.
- Do not subject the product to strong impacts or allow it to drop onto a hard surface. This can cause a malfunction.
- To reduce the risk of hazards, use only CSA/UL Certified power supply cord set, cord is Type SPT-2 or heavier, minimum NO.18 AWG copper, one end with a molded-on male attachment plug cap (with a specified NEMA configuration), and the other is provided with a molded-on female connector body (with a specified IEC nonindustrial type configuration) or the equivalent.

Care to be Taken During Handling

Before Using Your Camera

- When traveling, take the Worldwide Service Network listing that is included in the package. This will be useful if you experience problems abroad.
- When the camera has not been used for a long time, confirm that it is still working properly, particularly prior to taking important pictures (such as at a wedding or when traveling). Contents of the recording cannot be guaranteed if recording, playback or transferring your data to a computer, etc. is not possible due to a malfunction of your camera or recording media (SD Memory Card), etc.

Precautions on Carrying and Using Your Camera

- The lens on this camera is not interchangeable. The lens is not removable.
- Do not subject the camera to high temperatures or high humidity. Do not leave the camera in a vehicle, as the temperature can get very high.
- As this camera is not waterproof, do not use the camera where it may come in contact with rain, water or any other liquid.
- Do not subject the camera to strong vibrations, shocks, or pressure. Use a cushion to protect the camera from vibrations of motorcycles, automobiles, or ships. If the camera is subjected to strong vibrations, shocks or pressure, take your camera to your nearest PENTAX Service Center and have it checked.

- The temperature range in which the camera can be used is 0°C to 40°C (32°F to 104°F).
- The monitor may appear black under high temperatures, but will return to normal as temperatures normalize.
- The response speed of the liquid crystal display becomes slow at low temperatures. This is due to the properties of the liquid crystal and is not a fault.
- Sudden temperature changes will cause condensation on the inside and outside of the camera. Place the camera in your bag or a plastic bag, removing the camera after temperature of the camera and surroundings are equalized.
- Be careful not to allow dirt, mud, sand, dust, water, toxic gases or salt to enter the camera as this may damage the camera. Wipe away any raindrops or water droplets and allow the camera to dry.
- Please do not press forcefully on the display. This could cause breakage or malfunction.
- Be careful not to sit down with the camera in your back pocket as this may damage the exterior of the camera or the display.
- When using a tripod with the camera, be careful not to overtighten the screw in the tripod socket on the camera.

Cleaning Your Camera

- Do not clean the product with organic solvents such as thinner, alcohol or benzene.





Storing Your Camera

- Do not store the camera with preservatives or chemicals. Storage in high temperatures and high humidity can cause mold to grow on the camera. Remove from the case and store in a dry and well-ventilated location.

Other Precautions

- Periodic checks are recommended every 1 to 2 years in order to maintain high performance.
- Refer to “Precautions When Using an SD Memory Card” (p.33) regarding the SD Memory Card.
- Please note that deleting images or sound files, or formatting the SD Memory Cards or the built-in memory does not completely erase the original data. Deleted files can sometimes be recovered using commercially available software. It is the user’s responsibility to ensure the privacy of such data.

Contents

USING YOUR CAMERA SAFELY	1
Care to be Taken During Handling	4
Contents	6
Composition of the Operating Manual	11
Camera Features	12
Checking the Contents of the Package	15
Names of Parts	16
Names of Operating Parts	17
Monitor Indications	18
Getting Started	25
Attaching the Strap	26
Powering the Camera	27
Installing the Batteries	27
Using the AC Adapter	29
Installing the SD Memory Card	31
Number of Images Recordable on an SD Memory Card	34
Turning the Camera On and Off	35
Playback Mode	36
Initial Settings	37
Setting the Display Language	37
Setting the Date and Time	41
Common Operations	43
Understanding the Button Functions	44
 Mode	44
 Mode	46
Switching Between  Mode and  Mode	48
Setting the Camera Functions	49
Operating the Menus	49
Menu List	53
Taking Pictures	55
Taking Still Pictures	56
Taking Pictures	56
Setting the Shooting Mode	59
Using the Face Detection Function	61
Taking Pictures Automatically (Auto Picture Mode)	63
Taking Pictures in the Custom Settings (Program Mode)	64

Taking Pictures in the Basic Mode (Green Mode).....	66
Using the Zoom	67
Taking Pictures of Dark Scenes (Night Scene/Night Scene Portrait/ Digital SR/Sunset/Candlelight Mode).....	70
Taking Pictures of People (Half-length Portrait/ Portrait/ Natural Skin Tone Mode)	71
Taking Pictures of Children (Kids Mode).....	72
Taking Pictures of Your Pet (Pet Mode).....	73
Taking Pictures of Sports and Leisure Activities (Surf & Snow/ Sport Mode)	74
Framing Your Pictures (Frame Composite Mode).....	76
Using the Self-timer.....	78
Taking a Series of Pictures (Continuous Shooting/ 16-frame Shooting Mode)	79
Taking Panoramic Pictures (Digital Panorama Mode).....	81
Setting the Shooting Functions.....	84
Selecting the Flash Mode	84
Selecting the Focus Mode	86
Selecting the Recorded Pixels.....	88
Setting the Exposure (EV Compensation).....	90
Setting the Sensitivity	90
Setting the Date Imprint Function	92
Recording Movies	93
Recording a Movie.....	93
Selecting the Recorded Pixels for Movies	94
Setting the Movie SR (Movie Shake Reduction) Function.....	96
Saving the Settings (Memory)	97
Playing Back and Deleting Images	99
Playing Back Images	100
Playing Back Still Pictures	100
Playing Back a Movie	101
Four-Image Display, Nine-Image Display, Folder Display and Calendar Display.....	102
Using the Playback Function	104
Slideshow	106
Rotating the Image	108
Zoom Playback.....	109
Zoom In on the Subject's Face Automatically (Face Close-up Playback)	110

Deleting Images	111
Deleting a Single Image	111
Deleting Selected Images.....	112
Deleting All Images.....	114
Recovering Deleted Images	115
Protecting Images from Deletion (Protect)	116
Connecting the Camera to AV Equipment.....	119
Editing and Printing Images	121
<hr/>	
Editing Images	122
Changing the Image Size (Resize).....	122
Cropping Images	123
Using the Digital Filters.....	125
Red-eye Compensation.....	128
Adding a Frame (Frame Composite).....	129
Copying Images.....	133
Setting the Printing Service (DPOF).....	135
Printing Single Images.....	135
Printing All Images.....	137
Settings	139
<hr/>	
Camera Settings.....	140
Formatting an SD Memory Card.....	140
Changing the Sound Settings.....	141
Changing the Date and Time.....	142
Setting the World Time	145
Changing the Display Language	147
Changing the Naming System of the Folder.....	148
Changing the Video Output Format.....	149
Adjusting the Brightness of the Display	150
Using the Power Saving Function	151
Setting Auto Power Off.....	152
Resetting to Default Settings (Reset)	153
Viewing Images on a Computer	155
<hr/>	
Setting Up Your Computer.....	156
Provided Software	156
System Requirements	156
Installing the Software	158
Setting the USB Connection Mode	161

Connecting to Your Computer	163
Connecting the Camera and the Computer.....	163
Transferring Images	164
Disconnecting the Camera from Your Computer.....	167
Starting "MediaImpression 2.0 for PENTAX".....	168
Details on How to Use "MediaImpression 2.0 for PENTAX".....	170
Appendix	171
<hr/>	
Functions Available for Each Shooting Mode	172
Messages	174
Troubleshooting	176
Default Settings	178
List of World Time Cities	182
Optional Accessories	183
Main Specifications	184
WARRANTY POLICY	188
Index	194

In this manual, the method for operating the four-way controller is shown in illustrations, such as in the one below.

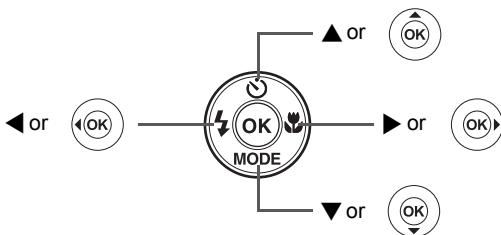

The meanings of the symbols used in this Operating Manual are explained below.

	indicates the reference page number for an explanation of the related operation.
	indicates information that is useful to know.
	indicates precautions to be taken when operating the camera.
mode	This is the mode for capturing still pictures and recording movies. In this manual, the mode for taking still pictures is referred to as the “Still Picture Capture Mode” and the mode for recording movies is referred to as the “ mode”.
mode	This is the mode for viewing still pictures and playing back movies.

Composition of the Operating Manual

This Operating Manual contains the following chapters.

1 Getting Started

This chapter explains what you need to do after purchasing the camera before you start taking pictures. Be sure to read it and follow the instructions.

2 Common Operations

This chapter explains common operations such as the functions of the buttons and how to use the menus. For more details, refer to the respective chapters below.

3 Taking Pictures

This chapter explains the various ways of capturing images and how to set the relevant functions.

4 Playing Back and Deleting Images

This chapter explains how to view still pictures and movies on the camera or on a TV and how to delete images from the camera.

5 Editing and Printing Images

This chapter explains the various ways of printing still pictures and how to edit images with the camera. For information on transferring images to a computer and installing the provided application software, see "Connecting with Computers" in chapter 7. For details on editing and printing images on a computer, see the Help menu of the application software.

6 Settings

This chapter explains how to set the camera-related functions.

7 Viewing Images on a Computer

This chapter explains how to connect the camera to your computer, install the supplied CD-ROM S-SW104, etc.

8 Appendix

This chapter deals with troubleshooting and lists the optional accessories.

Camera Features

In addition to basic picture-taking, the Optio E90 has a variety of shooting modes to suit different situations. This section describes how to make the most of the key features of your camera. Together with the explanations of camera operations, it will enable you to enjoy your camera to the full.

Advanced Movie Recording and Picture Taking Functions

The Optio E90 has a shake reduction function to reduce camera shake during movie recording (p.96).

- **Use the camera to shoot fun-filled movies of your children or pets as a visual diary of their development (p.93).**

Perfect for Portrait Shots!

The Optio E90 comes with a “Face Detection” function that spots the faces in your shot and automatically adjusts the focus and exposure for the faces. It can detect up to 10 people per shot (*), so it will help you take perfect group shots too. It will automatically release the shutter when people are smiling, so you can always get the best shot. It also has a feature that lets you enlarge each person’s face in sequence during playback so you can quickly check their facial expressions.

* Up to 10 face detection frames are displayed on the monitor.

- **Face Detection function (p.61)**
- **Modes for taking stunning pictures of people (p.71)**
- **Face Close-up Playback for easy checking during playback (p.110)**

Add Various Frames to Your Pictures!

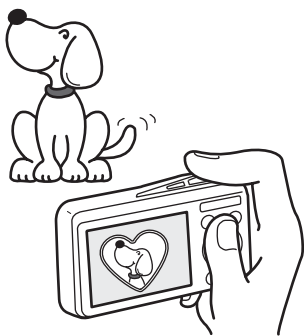

When you take a picture with the Optio E90, you can choose from a wide range of fun frames to create attractive framed shots (p.76). You can also add frames to pictures you have taken and adjust the position of the subject in the picture or reduce or enlarge the picture size to match the frame shape and size. Now you no longer have to worry about the subject not being aligned in the frame (p.129).

- For decorating your pictures with a frame.

Easy-to-Navigate Capture and Playback Functions!

The user-friendly design of the Optio E90 enables easy operation with only a few buttons. Simply by choosing the appropriate icon, you can select the shooting mode (p.59) and choose the optimal settings for the situation, or the playback mode (p.104, p.122) and enjoy the various playback and editing functions. A guide on the display lets you check the functions available in each mode and how to use them.



- A shooting mode guide is displayed in the Capture Mode Palette and a playback mode guide in the Playback Mode Palette (p.59, p.104).
- Use the Green Mode to take pictures easily using standard settings (p.66).

Display Images in Calendar Format!

With the Optio E90, you can display recorded images by date in calendar format (p.103). This lets you quickly find the image you want to play back.

A multitude of functions inside the camera for enjoying images without a Computer!

The Optio E90 has a variety of functions to let you enjoy playing back and editing images without having to connect the camera to your computer and transfer the images first. The camera is all you need to take and edit still pictures (p.122). And no more worries about accidentally deleting images, because now, with the Optio E90, you can recover them again (p.115).



- **Resize (p.122), Cropping (p.123) and Red-eye Compensation (p.128) can be used, while the image is displayed in the playback mode.**

Checking the Contents of the Package



Camera
Optio E90

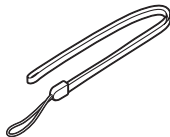

Strap
O-ST86 (*)

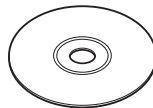

Software (CD-ROM)
S-SW104

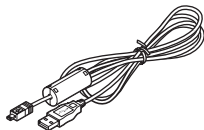

USB cable
I-USB98 (*)



Two AA
alkaline batteries

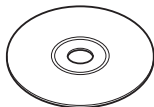

Operating Manual
(this manual)



Quick Guide

Items marked with an asterisk (*) are also available as optional accessories. For other optional accessories, refer to "Optional Accessories" (p.183).

Names of Parts

Front

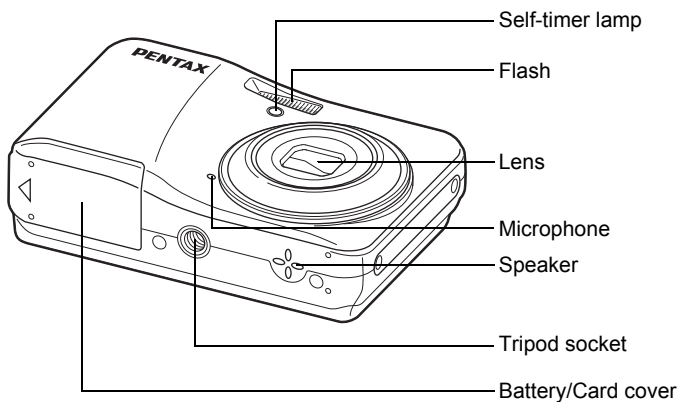

Back

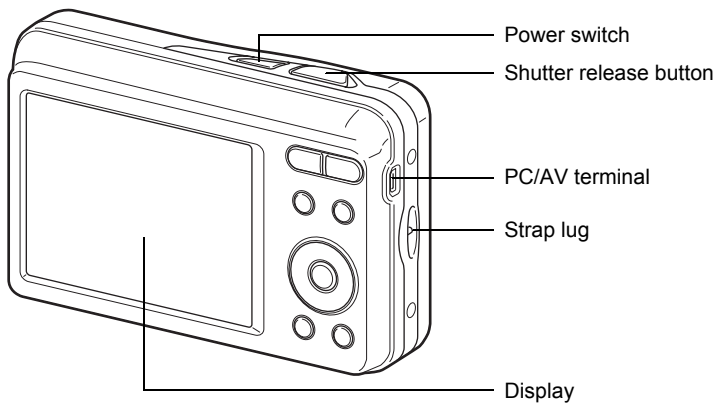

Names of Operating Parts

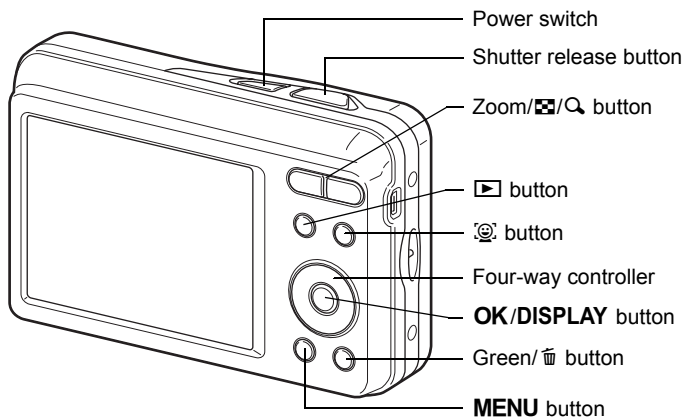

Refer to “Understanding the Button Functions” (p.44 - p.47) for an explanation of the function of each button.



Monitor Indications

Display in Mode

The display shows information such as the camera settings in the capture mode.

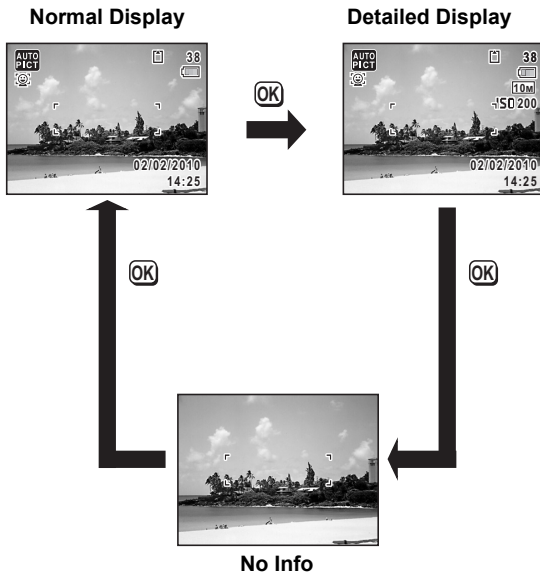
The display changes in the following sequence each time you press the **OK/DISPLAY** button: Normal Display, Detailed Display, No Info.



- To prevent camera shake, use a tripod and/or the self-timer function (p.78).
- When the shooting mode is set to  (Green) mode, the monitor display is as shown on the right. You cannot change the information on the display by pressing the **OK/DISPLAY** button.
- While shooting in  (Movie) mode, you cannot change the information on the display by pressing the **OK/DISPLAY** button. The display is fixed at Normal Display.



Normal Display in Still Picture Capture Mode

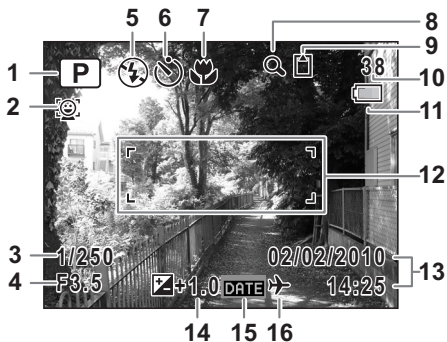

- | | |
|---|-------------------------------------|
| 1 Shooting mode (p.59) | 9 Memory status (p.35) |
| 2 Face Detection icon (p.61) | 10 Remaining image storage capacity |
| 3 Shutter speed | 11 Battery level indicator (p.29) |
| 4 Aperture | 12 Focus frame (p.56) |
| 5 Flash mode (p.84) | 13 Date and time (p.41) |
| 6 Drive mode (p.78, p.79) | 14 EV compensation (p.90) |
| 7 Focus mode (p.86) | 15 Date Imprint setting (p.92) |
| 8 Digital zoom/Intelligent zoom icon (p.67) | 16 World time setting (p.145) |

- * 3 and 4 appear only when the shutter release button is pressed halfway.
- * As to 7, when the focus mode is set to **AF** and the Auto-Macro function is activated, the  appears on the display (p.86).
- * Some indications may not appear depending on the shooting mode.

Detailed Display/No Info Display in Still Picture Capture Mode

A1 to A13 and B1 appear when “Detailed Display” is selected. Only B1 appears when “No Info” is selected.



- | | |
|---|--|
| A1 Shooting mode (p.59) | A9 Battery level indicator (p.29) |
| A2 Face Detection icon (p.61) | A10 Recorded pixels (p.88) |
| A3 Flash mode (p.84) | A11 Sensitivity (p.90) |
| A4 Drive mode (p.78, p.79) | A12 EV compensation (p.90) |
| A5 Focus mode (p.86) | A13 Date Imprint setting (p.92) |
| A6 Digital zoom/
Intelligent zoom icon (p.67) | B1 Focus frame (p.56) |
| A7 Memory status (p.35) | B2 Shutter speed |
| A8 Remaining image storage capacity | B3 Aperture |

* B2 and B3 appear only when the shutter release button is pressed halfway.

* When the shooting mode is **AUTO PICT** (Auto Picture) and if you press the shutter release button halfway, the selected shooting mode appears in A1 even when “No Info” is selected (p.63).

* Some indications may not appear depending on the shooting mode.

Display in Mode

The display shows the shooting information of the image in  mode. The display changes in the following sequence each time you press the **OK/DISPLAY** button: Normal Display, Detailed Display, No Info.

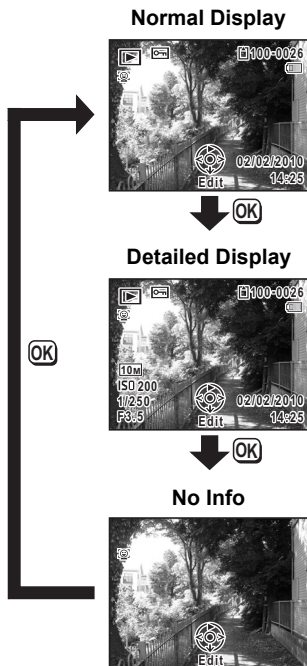

During movie playback, you cannot change the information on the display by pressing the **OK/DISPLAY** button. The display is fixed at Normal Display.

Normal Display/Detailed Display in Still Picture Playback Mode (All of the display items are displayed here for explanatory purposes.)

The display shows information such as the shooting conditions. A1 to A10 appear when “Normal Display” or “Detailed Display” is selected. B1 to B4 appear only when “Detailed Display” is selected.











- | | |
|--|--|
| A1 Playback mode
▶ : Still Picture Playback Mode (p.104) | A7 Battery level indicator (p.29) |
| A2 Face Detection icon (p.61) | A8 Volume icon |
| A3 Protect icon (p.116) | A9 Captured date and time (p.41) |
| A4 Memory status (p.35) | A10 Four-way controller guide |
| A5 Folder number (p.148) | B1 Recorded pixels (p.88) |
| A6 File number | B2 Sensitivity (p.90) |
| | B3 Shutter speed |
| | B4 Aperture |

- * A2 appears only if the Face Detection function worked when the image was shot.
- * In “Normal Display”, A7 and A9 disappear if no operation is performed for two seconds.
- * A8 appears only when the volume is being adjusted during playback of movies. (p.101)
- * A10 appears even when “No Info” is selected, but disappears if no operation is performed for two seconds. When no operation is performed for two seconds in “Normal Display” or “Detailed Display”, only “Edit” disappears.

Guide Indications

A guide for each available button operation appears as follows on the display during operation.

Four-way controller (▲)	▲
Four-way controller (▼)	▼
Four-way controller (◀)	◀
Four-way controller (▶)	▶
MENU button	

Zoom button	
OK/DISPLAY button	
Shutter release button	
Green/  button	
 button	

Memo

1 Getting Started

Attaching the Strap	26
Powering the Camera	27
Installing the SD Memory Card	31
Turning the Camera On and Off	35
Initial Settings	37

Attaching the Strap

Attach the strap (O-ST86) supplied with the camera.

1

Getting Started

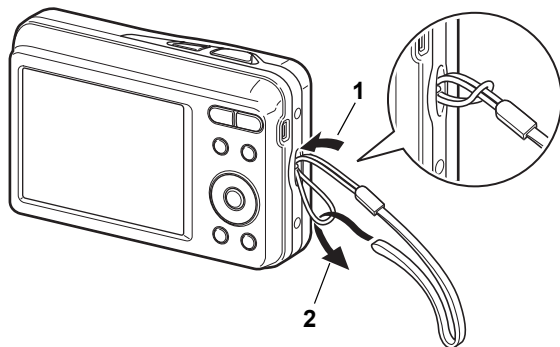

- 1** Pass the narrow end of the strap through the strap lug.
- 2** Pass the other end of the strap through the loop and pull tight.

Installing the Batteries

Install the batteries into the camera. Use two AA alkaline, AA lithium or AA Ni-MH batteries.

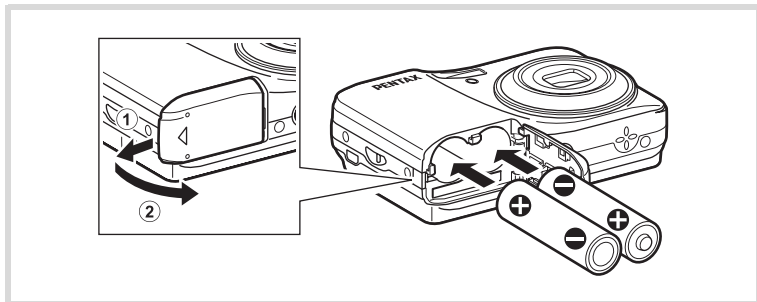

1 Open the battery/card cover.

Slide the battery/card cover in the direction ①. The cover will automatically open in the direction ② when you release your fingers from it.

2 Insert the batteries, making sure the (+) and (-) terminals on the batteries match the (+) and (-) symbols inside the battery compartment.



Make sure to check the direction of the batteries. If the battery is incorrectly oriented, malfunction may result.

3 Close the battery/card cover and slide it in the opposite direction of ①.



- AA alkaline and AA lithium batteries are not rechargeable.
- Do not open the battery/card cover or remove the batteries while the camera is turned on.
- If you do not intend to use the camera for a long time, remove the batteries. If the batteries are left in the camera for a long time, they may leak.
- If the batteries have been removed from the camera for a long time, when they are reinserted and the camera is turned on, the message [Battery depleted] may appear. This can also happen when using the camera for the first time; however this is not a malfunction. Turn the camera off, wait a minute and then turn the camera on again to reset the camera. The date and time may also be reset.
- Insert the batteries correctly. If the batteries are incorrectly oriented, malfunction may result. If the ends of the batteries look dirty, wipe them before inserting into the camera.
- Be careful as the camera or the batteries may become hot when the camera is used continuously for a long period of time.



Use the AC adapter kit K-AC62 (optional) if you intend to use the camera for a long time. (p.29)

Recordable Image No., Movie Recording Time, and Playback Time (When using new AA alkaline batteries at 23°C with the display on)

Recordable Image No.* ¹ (flash used for 50% of shots)	Movie Recording Time* ²	Playback Time* ²
Approx. 220 pictures	Approx. 100 min.	Approx. 400 min.

*1 Recording capacity shows approximate number of shots recorded during CIPA-compliant testing (with display on, flash used for 50% of the shots, and 23 degrees centigrade). Actual performance may vary according to operating conditions.

*2 According to the result of in-house testing.



- In general, battery performance may temporarily deteriorate as the temperature decreases. Be sure to take spare batteries when using the camera in a cold region and keep the batteries warm by placing them in your pocket or inside your coat. Battery performance that has deteriorated due to cold temperature will return to normal performance when the batteries reach room temperature.
- Due to their characteristics, AA alkaline batteries may not allow the camera to make full use of its capabilities when used at cold temperatures. Use of AA lithium or AA Ni-MH batteries is recommended when the camera is used at cold temperatures.
- Be sure to take spare batteries with you when traveling abroad or to a cold region, or if you intend to take a lot of pictures.

Battery Level Indicator

You can check the battery level by the indicator on the display.

Screen Display	Battery Status
(green)	Adequate power remains.
(green)	Batteries are running low.
(yellow)	Batteries are running very low.
(red)	Batteries are exhausted.
[Battery depleted]	The camera will turn off after this message appears.



AA nickel manganese batteries may not display the battery level correctly due to their characteristics. may be displayed for the battery level even if the batteries are running low. The camera may also turn off without warning even if is displayed.

Using the AC Adapter

Use of the AC adapter kit K-AC62 (optional) with a household power supply is recommended if you intend to use the camera for a long time or connect it to a computer.

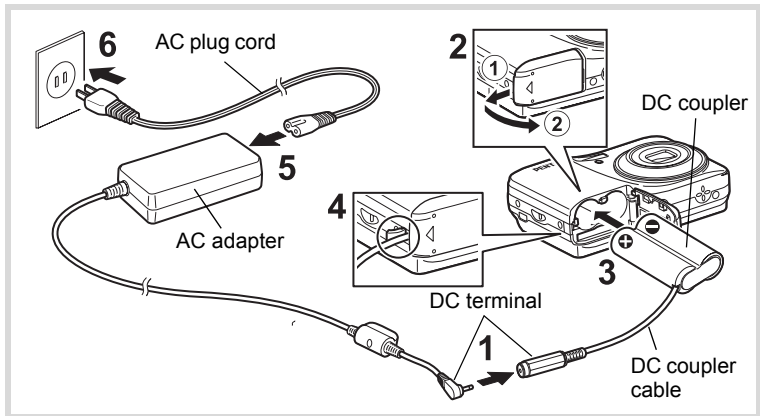

1 Connect the DC terminal of the AC adapter to the DC input terminal of the DC coupler.

2 Make sure that the camera is turned off and open the battery/card cover.

Slide the battery/card cover in the direction ①. The cover will automatically open in the direction ② when you release your fingers from it.

3 Insert the DC coupler into the battery compartment, making sure the (+) and (-) terminals on the coupler match the (+) and (-) symbols inside the battery compartment.

4 Open the DC coupler cable cover, pass the DC coupler cable through the opening, and close the battery/card cover.

Slide the battery/card cover in the opposite direction of ①. Slide the battery/card cover all the way in to make sure it is securely closed.

5 Connect the AC plug cord to the AC adapter.

6 Plug the AC plug cord into the power outlet.



- Make sure that the camera is turned off before connecting or disconnecting the AC adapter.
- Make sure that the AC plug cord and the DC coupler cable are inserted securely. The data may be lost if either becomes disconnected while data is being recorded on the SD Memory Card or the built-in memory.
- Use the AC adapter with due care to avoid fire or electric shock. Be sure to read "USING YOUR CAMERA SAFELY" (p.1) and "About the AC Adapter" (p.3) before using the AC adapter.
- Be sure to read the operation manual accompanying the AC adapter kit K-AC62 before using the adapter.

Installing the SD Memory Card

This camera uses either an SD Memory Card or an SDHC Memory Card. (Both cards are referred to as SD Memory Cards hereafter.) Captured images are saved on the SD Memory Card if a card is inserted in the camera. They are saved in the built-in memory if a card is not inserted (p.35).



- **Be sure to use this camera to format (initialize) an SD Memory Card that is unused or has been used in other cameras or digital devices. Refer to “Formatting an SD Memory Card” (p.140) for instructions on formatting.**
- Make sure that the camera is turned off before inserting or removing the SD Memory Card.



- The still picture storage capacity varies depending on the capacity of the SD Memory Card and the selected number of recorded pixels (p.34).
- The power switch blinks while the SD Memory Card is being accessed (data is being recorded or read).

Backing Up Data

The camera may not be able to access data in the built-in memory in the case of a malfunction. Use a computer or other device to back up important data in another location.

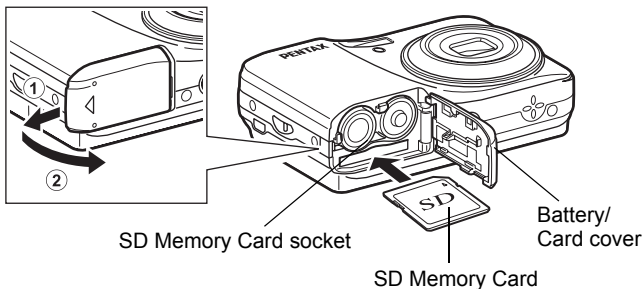

- 1 Open the battery/card cover.**

Slide the battery/card cover in the direction ①. The cover will automatically open in the direction ② when you release your fingers from it.
- 2 Insert the SD Memory Card into the SD Memory Card socket so that the label is facing toward the display.**

Push the card in until it clicks. Images may not be recorded correctly if the card is not inserted all the way.
- 3 Close the battery/card cover and slide it in the opposite direction of ①.**

To Remove the SD Memory Card

- 1 Open the battery/card cover.**
- 2 Push the card into the SD Memory Card socket to eject it.**

Pull the card out.

Precautions When Using an SD Memory Card

- The SD Memory Card is equipped with a write-protect switch. Setting the switch to LOCK prevents new data from being recorded on the card, the stored data from being deleted, and the card from being formatted by the camera or computer.
 appears on the display when the card is write-protected.
- Care should be taken when removing the SD Memory Card immediately after using the camera, as the card may be hot.
- Keep the card cover closed and do not remove the SD Memory Card or turn the camera off while images are being played back or saved to the card, or the camera is connected to a computer with the USB cable, as this may cause the data to be lost or the card to be damaged.
- Do not bend the SD Memory Card or subject it to violent impact. Keep it away from water and store away from high temperature.
- Do not remove the SD Memory Card during formatting as this may damage the card and render it unusable.
- The data on the SD Memory Card may be deleted in the following circumstances. We do not accept any liability for data that is deleted
 - (1) when the SD Memory Card is mishandled by the user.
 - (2) when the SD Memory Card is exposed to static electricity or electrical interference.
 - (3) when the card has not been used for a long time.
 - (4) when the card is ejected or the batteries are removed while the data on the card is being recorded or accessed.
- If it is not used for a long time, the data on the card may become unreadable. Be sure to regularly make a backup of important data on a computer.
- Avoid using or storing the card where it may be exposed to static electricity or electrical interference.
- Avoid using or storing the card in direct sunlight or where it may be exposed to rapid changes in temperature or to condensation.
- When using an SD Memory Card with a slow recording speed, recording may stop while you are taking movies even when there is adequate space in the memory, or shooting and playback may take a long time.
- Be sure to format an SD Memory Card that is unused or has been used on another camera. Refer to "Formatting an SD Memory Card" (p.140).

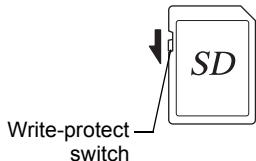

Number of Images Recordable on an SD Memory Card

1

Getting Started

The sizes of the recorded images differ depending on the number of recorded pixels of the images, so the number of images that will be saved on an SD Memory Card also differs.

Choose the appropriate number of recorded pixels for still pictures on the [📷 Rec.Mode] menu.

Selecting the Recorded Pixels 📷 p.88

Choose the appropriate number of recorded pixels in [Movie] on the [📷 Rec.Mode] menu.

Selecting the Recorded Pixels for Movies 📷 p.94

For an approximate guide to the number of images or the length of recorded movies that will be saved on an SD Memory Card, see “Main Specifications” (p.185).

Turning the Camera On and Off

1

Getting Started

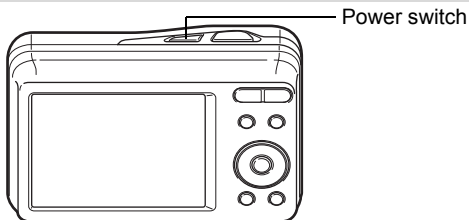

1 Press the power switch.

The camera turns on and the display turns on.

When you turn the camera on, the lens cover opens and the lens extends.

If the [Language/言語] screen or [Date Adjustment] screen appears when you turn the camera on, follow the procedure on p.37 to set the display language and/or current date and time.

2 Press the power switch again.

The display turns off, the lens closes, and the camera turns off.

Taking Still Pictures p.56

Checking the Memory Card

The memory card is checked when the camera turns on and the memory status is displayed.

- : The SD Memory Card is inserted.
Images will be saved on the SD Memory Card.
- : The SD Memory Card is not inserted.
Images will be saved in the built-in memory.
- : The write-protect switch on the SD Memory Card is in the LOCK position (p.33).
Images cannot be recorded.

Memory status



If the batteries have been removed from the camera for a long time, when they are reinserted and the camera is turned on, the message [Battery depleted] may appear. This can also happen when using the camera for the first time; however this is not a malfunction. Turn the camera off, wait a minute and then turn the camera on again to reset the camera. The date and time and other settings may also be reset. Follow the procedure on p.37 to set these settings again.

Playback Mode

Use this mode when you want to play back an image straightaway without taking any more pictures.

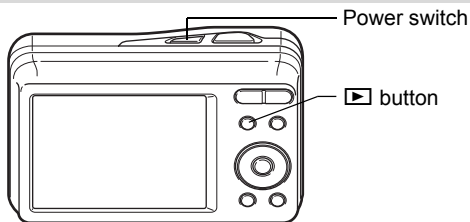

1 Press the power switch while holding down the ▶ button.

The display turns on with the lens retracted and the camera turns on in the playback mode.



To switch from the playback mode to the capture mode, press the ▶ button or press the shutter release button halfway.

Playing Back Still Pictures p.100

Initial Settings

1

Getting Started

The [Language/言語] screen appears when the camera is turned on for the first time. Perform the operations in “Setting the Display Language” below to set the language, and in “Setting the Date and Time” (p.41) to set the current date and time.

Language, Date, and Time can be changed later. Refer to the pages below for instructions.

- To change the language, follow the steps in “Changing the Display Language” (p.147).
- To change the date and time, follow the steps in “Changing the Date and Time” (p.142).

Setting the Display Language

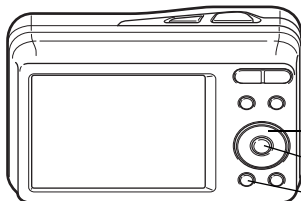

Four-way controller

OK button

MENU button

1

Use the four-way controller (▲▼◀▶) to choose the display language.

Language/言語		
English	日本語	Türkçe
Français	Dansk	Ελληνικά
Deutsch	Svenska	Русский
Español	Suomi	ไทย
Português	Polski	한국어
Italiano	Čeština	中文繁體
Nederlands	Magyar	中文简体
MENU	Cancel	OK

2 Press the OK button.

The [Initial Setting] screen appears in the selected language. If the desired settings for [Hometown] and [DST] (Daylight Saving Time) appear, press the four-way controller (▼) twice to select [Settings complete] and press the **OK** button to display the [Date Adjustment] screen. Go to “Setting the Date and Time” (p.41).

Go to Step 3 in “To Set Hometown and DST” (p.40) if the desired settings do not appear.

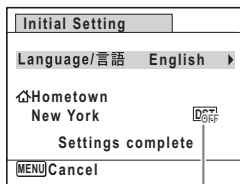

Daylight saving time

If you accidentally select another language and go to the next procedure, perform the following operation to set the language back.

● **When Another Language Has Been Inadvertently Selected**

- 1 Press the four-way controller (▶).**
- 2 Use the four-way controller (▲ ▼ ◀ ▶) to select the language and press the OK button.**

The [Initial Setting] screen appears in the selected language.

● **When the Screen After Step 2 Appears in Another Language**

- 1 Press the OK button.**
- 2 Press the MENU button.**
- 3 Press the four-way controller (▶).**
- 4 Use the four-way controller (▼ ▲) to select [Language/言語].**
- 5 Press the four-way controller (▶).**
The [Language/言語] screen appears.
- 6 Use the four-way controller (▲ ▼ ◀ ▶) to select the language.**
- 7 Press the OK button.**

The [↶ Setting] menu appears in the selected language.

The language is now switched to your desired language. To reset [Hometown], [Date] and [Time], refer to the pages below for instructions.

- To change [Hometown], follow the steps in “Setting the World Time” (☞p.145).
- To change the [Date] and [Time], follow the steps in “Changing the Date and Time” (☞p.142).

To Set Hometown and DST

1

Getting Started

3 Press the four-way controller (▼).

The frame moves to [Hometown].

4 Press the four-way controller (▶).

The [Hometown] screen appears.

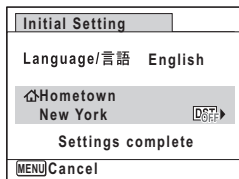

5 Use the four-way controller (◀▶) to choose the city.

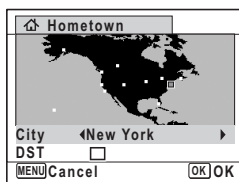

6 Press the four-way controller (▼).

The frame moves to [DST] (Daylight Saving Time).

7 Use the four-way controller (◀▶) to select (On) or (Off).

8 Press the OK button.

The [Initial Setting] screen appears.

9 Press the four-way controller (▼) to select [Settings complete].

10 Press the OK button.

The [Date Adjustment] screen appears. Next, set the date and time.

Setting the Date and Time

Set the current date and time and the display style.

1 Press the four-way controller (▶).

The frame moves to [mm/dd/yy].

2 Use the four-way controller (▲▼) to choose the date and time display style.

Choose from [mm/dd/yy], [dd/mm/yy] or [yy/mm/dd].

Date Adjustment	
Date Format	mm/dd/yy 24h
Date	01/01/2010
Time	00:00
Settings complete	
[MENU] Cancel	

3 Press the four-way controller (▶).

The frame moves to [24h].

4 Use the four-way controller (▲▼) to select [24h] (24-hour display) or [12h] (12-hour display).

Date Adjustment	
Date Format	mm/dd/yy 24h
Date	01/01/2010
Time	00:00
Settings complete	
[MENU] Cancel	

5 Press the four-way controller (▶).

The frame returns to [Date Format].

6 Press the four-way controller (▼).

The frame moves to [Date].

7 Press the four-way controller (▶).

The frame moves to the month.

Date Adjustment	
Date Format	mm/dd/yy 24h
Date	01/01/2010
Time	00:00
Settings complete	
[MENU] Cancel	

8 Use the four-way controller (▲▼) to change the month.

Change the day and year in the same manner.

Next, change the time.

If you selected [12h] in Step 4, the setting switches between am and pm corresponding to the time.

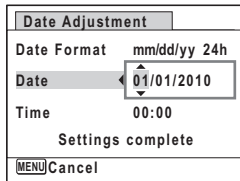

9 Press the four-way controller (▼) to select [Settings complete].

10 Press the OK button.

The setting is saved and the camera returns to capture status.

[Language/言語], [Date], [Time], [Hometown], and [DST] can be changed. Refer to the pages below for instructions.

- To change the language, follow the steps in “Changing the Display Language” (p.147).
- To change the date and time, follow the steps in “Changing the Date and Time” (p.142).
- To change the city or turn DST on and off, follow the steps in “Setting the World Time” (p.145).



When the [Initial Setting] or [Date Adjustment] screen is displayed, you can cancel the setting operation and switch to the capture mode by pressing the **MENU** button. In this case, the [Initial Setting] screen will appear next time you turn the camera on.



If you press the **OK** button in Step 10, the camera clock is reset to 00 seconds. To set the exact time, press the **OK** button when the time signal (on the TV, radio, etc.) reaches 00 seconds.

The video output format (NTSC/PAL) is set to the format of the city selected in [Hometown] on the [Initial Setting] screen. Refer to “List of World Time Cities” (p.182) for the video output format of each city set as the initial setting, and “Changing the Video Output Format” (p.149) for changing the setting of the video output format.

2 Common Operations



Understanding the Button Functions	44
Setting the Camera Functions	49

Understanding the Button Functions

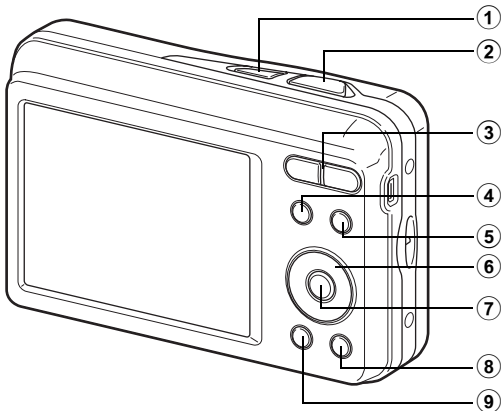







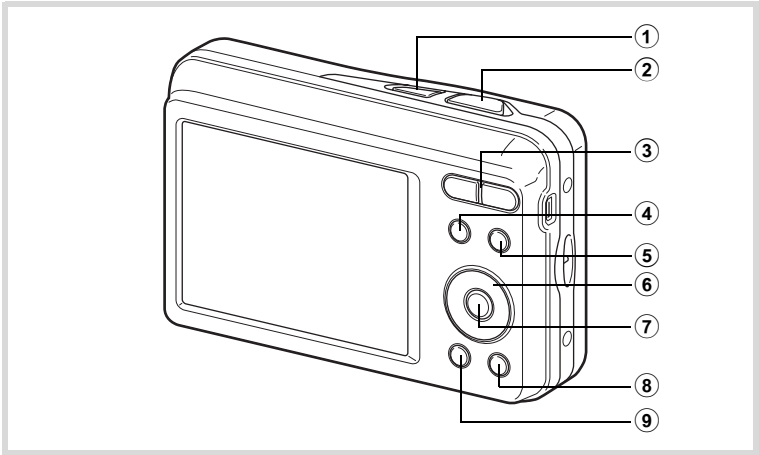

Mode



- ① **Power switch**
Turns the camera on and off (p.35).
- ② **Shutter release button**
Focuses the camera on the subject when pressed halfway in Still Picture Capture Mode (except in **PF** and **▲** modes).
Takes the still picture when pressed down fully (p.57).
Starts and stops movie recording in **Movie** mode (p.93).
- ③ **Zoom button**
Changes the captured area (p.67).
- ④ **▶ button**
Switches to the ▶ mode (p.48).
- ⑤ **☺ button**
Switches the Face Detection function (p.61). The Face Detection function is switched as follows each time the ☺ button is pressed:
Smile Capture → Face Detection Off → Face Detection On

- ⑥ **Four-way controller**
- (▲) Changes the drive mode (p.78, p.79).
 - (▼) Displays the Capture Mode Palette (p.59).
 - (◀) Changes the flash mode (p.84).
 - (▶) Changes the focus mode (p.86).
- ⑦ **OK/DISPLAY button**
Changes the information on the display (p.18).
- ⑧ **Green button**
Switches to the  (Green) mode (p.66).
- ⑨ **MENU button**
Displays the [ Rec.Mode] menu (p.49).



- ① **Power switch**
Turns the camera on and off (p.35).
- ② **Shutter release button**
Switches to  mode (p.48).
- ③ **Zoom//Playback button**
Press  during single-image display to change to four-image display, and press  again to change to nine-image display. Returns to the previous display when  is pressed (p.102).
Enlarges the image when  is pressed during single-image display. Returns to the previous display when  is pressed (p.109).
Press  during nine-image display to change to folder or calendar display (p.103).
Press  during folder display to change to the normal nine-image display (p.103).
Press  during calendar display to change to the normal nine-image display (p.103).
Adjusts the volume during playback of movies (p.101).
- ④ **▶ button**
Switches to  mode (p.48).

5 button

Zooms in on the subject's faces in a face-detected image in the order the faces were detected when the picture was taken. (Face close-up playback) (p.110).

6 **Four-way controller**

(▲) Plays back and pauses a movie (p.101).

(▼) Displays the Playback Mode Palette (p.104).

Stops a movie during playback (p.101).

(◀▶) Displays the previous or next image during single-image display (p.100).

Frame forwards, frame reverses, plays back in reverse, plays back normally, plays back in fast-forward, and plays back in reverse fast-forward when playing back movies (p.101).

(▲▼◀▶) Moves the display area during zoom display (p.109).

Selects an image in four-image/nine-image display, a folder in folder display, and a date in calendar display (p.102, p.103).

Moves the image when using the Frame Composite function (p.129).

7 **OK/DISPLAY button**

Changes the information on the display (p.18).

Returns zoom display or four-image/nine-image display to single-image display (p.102, p.109).

Changes to nine-image display of the selected folder during folder display (p.103).

Changes to single-image display of the selected date during calendar display (p.103).

8 **Green/ button**

Switches from single-image display to the Delete screen (p.111).

Switches from four-image/nine-image display to the Select & Delete screen (p.112).

Switches from folder display to the calendar display screen (p.103).

Switches from calendar display to the folder display screen (p.103).

Saves the paused frame as a single image during the playback of a series of successive images taken with 16-frame shooting function. (p.101)

9 **MENU button**

Displays the [ Setting] menu during single-image display (p.49).



Returns to single-image display during Playback Mode Palette display (p.104).

Returns zoom display or four-image/nine-image display to single-image display (p.102).

Changes to nine-image display of the selected folder during folder display (p.103).

Changes to nine-image display of the selected date during calendar display (p.103).

Switching Between Mode and Mode

In this manual, the capture mode, such as for taking still pictures, is referred to as “ mode” (the capture mode). The playback mode, such as for displaying captured images on the display, is referred to as “ mode” (the playback mode). In  mode, you can perform simple editing operations on the images that are played back.

Follow the procedure below to switch between  mode and  mode.

To Switch from Mode to Mode

1 Press the button.

The camera switches to  mode.

To Switch from Mode to Mode

1 Press the button or the shutter release button halfway.

The camera switches to  mode.



Displaying data stored in the built-in memory

When an SD Memory Card is inserted in the camera, images and movies on the SD Memory Card are displayed. If you want to display images and movies in the built-in memory, turn the camera off and remove the SD Memory Card, or follow the procedure below to use the “Built-in memory display” function.



Make sure that the camera is turned off before inserting or removing the SD Memory Card.

● Viewing images in the built-in memory while the SD Memory Card is inserted (built-in memory display)

- When you press and hold down the  button for more than 1.2 seconds in  mode or while a menu is being displayed, the lens is retracted. After the message [Plays back stored images in the built-in memory] appears, images and movies stored in the built-in memory are displayed.
- In the built-in memory display, you can play back still pictures (including enlarged display) (p.100, p.109) and movies (p.101), and switch between four-image display, nine-image display, folder display, and calendar display (p.102).
- In the built-in memory display, you cannot delete data, delete a selection, display the Playback Mode Palette, or display the menu. If you want to perform any of these operations on images or movies in the built-in memory, do so after removing the SD Memory Card.

Setting the Camera Functions

To change the camera settings, press the **MENU** button to display the [📷 Rec.Mode] menu or [⚙️ Setting] menu. Menus for playing back and editing images are displayed from the Playback Mode Palette.

Operating the Menus

Press the **MENU** button in 📷 mode to display the [📷 Rec.Mode] menu. Press the **MENU** button in ▶ mode to display the [⚙️ Setting] menu. Use the four-way controller (◀▶) to switch between [📷 Rec.Mode] menu and [⚙️ Setting] menu.

During recording

During playback

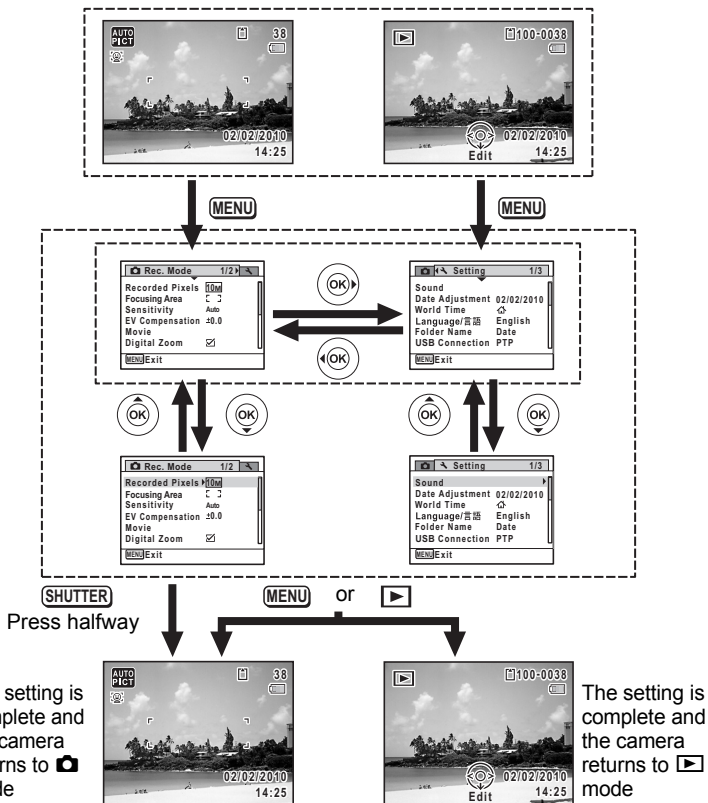

The setting is complete and the camera returns to mode

The setting is complete and the camera returns to mode



Available button operations appear on the display during menu operation.

Ex.) To set the [Focusing Area] on the [📷 Rec.Mode] menu

1 Press the MENU button in 📷 mode.

The [📷 Rec.Mode] menu appears.

2 Press the four-way controller (▼).

The frame moves to [Recorded Pixels].

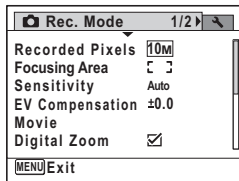

3 Press the four-way controller (▼).

The frame moves to [Focusing Area].

4 Press the four-way controller (▶).

A pull-down menu appears with the items that can be selected.

The pull-down menu displays only those items that can be selected with the current camera settings.

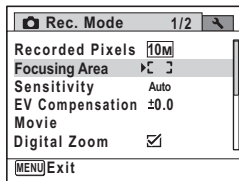

5 Use the four-way controller (▲▼) to change the setting.

The focusing area changes each time the four-way controller (▲▼) is pressed.

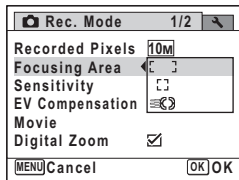

6 Press the OK button or the four-way controller (◀).

The setting is saved and then the camera is ready for setting the other functions. To exit the settings, press the **MENU** button.

To use another operation, refer to the alternate Step 6 options on the next page.

To Save the Setting and Start Taking Pictures

6 Press the shutter release button halfway.

The setting is saved and the camera returns to capture status.
When the shutter release button is pressed fully, the picture is taken.



When the [Setting] menu is displayed from mode, you can switch to mode by pressing the button.

To Save the Setting and Begin Playback of Images

6 Press the button.

When the [Rec.Mode] menu is displayed from mode, the setting is saved and the camera returns to playback status.

To Cancel the Changes and Continue with Menu Operations

6 Press the MENU button.

The changes are canceled and the screen returns to Step 3.



The **MENU** button function differs depending on the screen. Refer to the guide indications.

- Exit : Exits the menu and returns to the original screen.
- : Returns to the previous screen with the current setting.
- Cancel : Cancels the current selection, exits the menu and returns to the previous screen.

Menu List

This displays the items that can be set with the menus and provides descriptions of each item. See the list of default settings in the Appendix “Default Settings” (p.178) to decide whether you want the settings saved when the camera is turned off and whether you want the settings returned to the defaults when the camera is reset.

[📷 Rec.Mode] Menu

This menu shows the functions related to taking still pictures and recording movies.

Item	Description	Page	
Recorded Pixels	For choosing the number of recorded pixels of still pictures	p.88	
Focusing Area	For changing the area of the autofocus	p.87	
Sensitivity	For setting the sensitivity	p.90	
EV Compensation	For adjusting the overall brightness of the picture	p.90	
Movie	Recorded Pixels	For choosing the number of recorded pixels of movies	p.94
	Movie SR	For choosing whether or not to use the movie shake reduction function	p.96
Digital Zoom	For choosing whether or not to use the digital zoom function	p.69	
Memory	For choosing whether to save the set values of the shooting function or return to the defaults when the camera is turned off	p.97	
Date Imprint	For choosing whether to imprint the date and/or time when taking still pictures	p.92	



Use the  (Green) mode to enjoy easy picture-taking using standard settings, regardless of the settings in the [📷 Rec.Mode] menu (p.66).

[Setting] Menu

Item	Description	Page
Sound	For adjusting the operation volume and playback volume, and setting the start-up sound, shutter sound, key operation sound and self-timer sound	p.141
Date Adjustment	For adjusting the date and time	p.142
World Time	For setting the Hometown and Destination	p.145
Language/言語	For setting the language in which menus and messages appear	p.147
Folder Name	For choosing how names are assigned to folders for storing images	p.148
USB Connection	For setting the method for connecting to a computer (MSC or PTP).	p.161
Video Out	For setting the output format to the AV equipment	p.149
Brightness Level	For changing the brightness of the display	p.150
Power Saving	For setting the time until the camera enters power-saving mode	p.151
Auto Power Off	For setting the time until the camera turns off automatically	p.152
Reset	For returning settings other than the date and time, language, world time and video out to their defaults	p.153
Delete all	For deleting all images at once.	p.114
Format	For formatting the SD Memory Card	p.140

3 Taking Pictures

Taking Still Pictures	56
Setting the Shooting Functions	84
Recording Movies	93
Saving the Settings (Memory)	97

Taking Still Pictures

Taking Pictures

The Optio E90 features a wide range of shooting modes and functions to suit almost any subject or scene. This chapter describes how to take pictures with the most commonly used standard settings (the initial factory default settings).

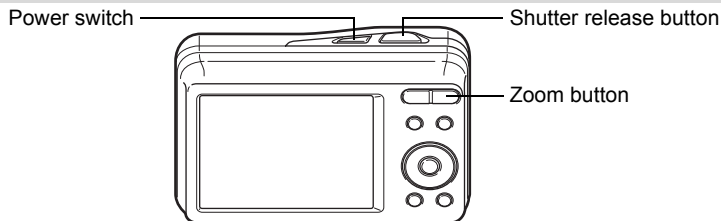

1 Press the power switch.

The camera turns on and is ready to take still pictures. In this manual, this is called Still Picture Capture Mode.

2 Confirm the subject and shooting information on the display.

The focus frame in the middle of the display indicates the zone of automatic focusing.

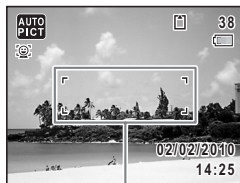

Focus frame

When the camera detects a face, the Face Detection function is activated and the face detection frame appears (p.61).

You can change the captured area by pressing the Zoom button to the left or right (p.67).

- T** (Right) enlarges the subject.
- W** (Left) widens the area that is captured by the camera.

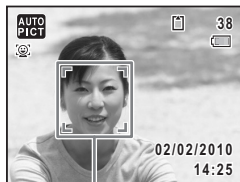

Face detection frame

3 Press the shutter release button halfway.

The focus frame (or face detection frame) on the display turns green when the camera focuses on the subject at the correct distance.



4 Press the shutter release button fully.

The picture is taken.

The flash discharges automatically depending on the light conditions. The image appears on the display for two seconds (Instant Review) and is saved to the SD Memory Card or the built-in memory.



Press the Green button to switch to the  (Green) mode and let the camera set all the shooting functions automatically (p.66).

Using the Shutter Release Button

The shutter release button works in a two-step action as follows.

Press halfway

This refers to pressing the shutter release button gently to the first position. This locks the focus setting and the exposure. The green focus frame lights on the display when the shutter release button is pressed halfway and the subject is in focus. If the subject is out of focus, the frame turns white.

Press fully

This refers to pressing the shutter release button all the way down to the fully depressed position. This takes a picture.

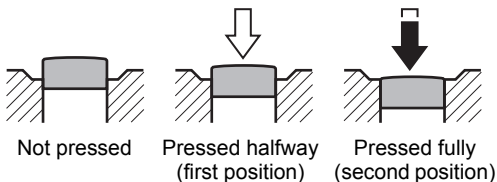

Poor focusing conditions

The camera may not be able to focus under the following conditions. In these cases, lock the focus on an object the same distance away as the subject (by pressing and holding the shutter release button halfway), then aim the camera at your subject and press the shutter release button fully.

- Objects that lack contrast such as a blue sky or white wall
- Dark places or objects, or conditions that prevent light being reflected back
- Horizontal lines or intricate patterns
- Fast moving objects
- When there is an object in the foreground and an object in the background in the captured area
- Strongly reflected light or strong backlighting (bright background)

Setting the Shooting Mode

The Optio E90 has a variety of shooting modes that let you take pictures or record movies in different situations simply by choosing the appropriate mode for the particular situation from the Capture Mode Palette.

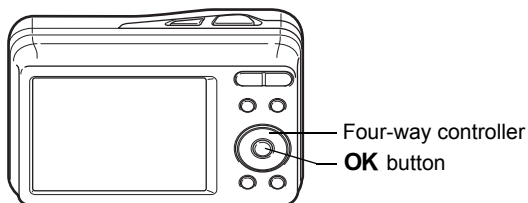

1 Press the four-way controller (▼) in mode.

The Capture Mode Palette appears.

2 Use the four-way controller (▲▼◀▶) to choose a shooting mode.

When an icon is selected in the Capture Mode Palette, the selected shooting mode guide appears.























3 Press the OK button.

The shooting mode is selected and the camera returns to capture status.



Some functions may not be available or may not function fully depending on the selected shooting mode. For details, refer to "Functions Available for Each Shooting Mode" (p.172).

There are 20 available shooting modes.

Shooting Mode		Description	Page
	Auto Picture	Automatically selects the best capture mode.	p.63
	Program	Used for basic shooting. Various functions can also be set with this mode.	p.64
	Night Scene	For night time images. Use of a tripod or other support is suggested.	p.70
	Night Scene Portrait	For images of people at night. Use of a tripod or other support is advised.	p.70
	Half-length Portrait	For portraits with proper framing by automatic zoom. Fixed at [3M] pixels.	p.71
	Movie	For recording movies.	p.93
	Landscape	For capturing landscape views. Enhances colors of sky and foliage.	—
	Flower	For images of flowers. The outline of the flower is softened.	—
	Portrait	For capturing portraits. Reproduces a healthy and bright skin tone.	p.71
	Surf & Snow	For bright images such as sand or snow. Accurately meters for bright scenes.	p.74
	Sport	For a fast moving subject. Tracks the subject until the picture is taken.	p.74
	Digital SR	Higher sensitivity reduces blur.	p.70
	Kids	For capturing moving kids. Reproduces a healthy and bright skin tone.	p.72
	Pet	For capturing moving pets. Select the color according to the pet's coat.	p.73
	Food	For images of food and prepared dishes. Enhances saturation and contrast.	—
	Natural Skin Tone	For images of people. Enhances skin tones while smoothing blemishes.	p.71
	Candlelight	For capturing scenes in candlelight.	p.70
	Digital Panorama	Stitches images taken with the camera to create a panoramic photograph.	p.81
	Frame Composite	For capturing images with a frame. Recorded pixels is fixed at [3M].	p.76
	Sunset	For images of sunsets and warm lighting.	p.70

Using the Face Detection Function

With the Optio E90, the Face Detection function is available with all shooting modes.

When the camera detects a person's face in the image, the Face Detection function displays a yellow face detection frame around the face on the display screen, sets the focus (Face Detection AF) and compensates the exposure (Face Detection AE).

If the subject in the face detection frame moves, the frame also moves and changes size as it tracks the face.

The Face Detection function can detect up to 10 people's faces. If it detects multiple faces, the camera displays a yellow frame over the main face and white frames over the other face(s). It can display up to a total of 10 frames, including a main frame and white frame(s).

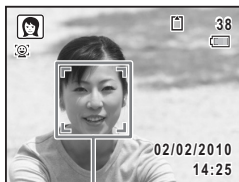

Face detection frame

When multiple faces are detected

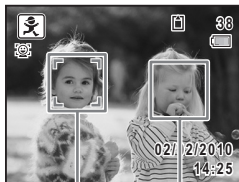

Main frame White frame



- Face Detection AF and AE may not work if the subject is wearing sunglasses, has part of the face covered or is not looking toward the camera.
- If the camera cannot detect the subject's face, the camera focuses using the setting currently selected in [Focusing Area].
- When the Smile Capture function is on, the shutter may not be released automatically because the Smile Capture function may not work in some situations, such as when the detected face is too small. In this case, press the shutter release button to take the picture.

To Switch the Face Detection Function

By default, the Face Detection function is set to Face Detection On. You can switch to Smile Capture, which automatically releases the shutter when your subject smiles. The Face Detection function is switched as follows each time the  button is pressed: Smile Capture → Face Detection Off → Face Detection On

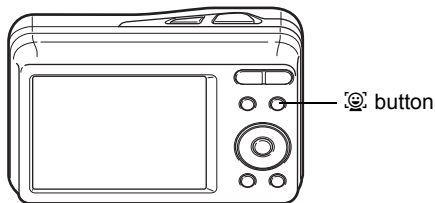

An icon indicating Face Detection On or Smile Capture appears when switched to either face detection function. (The icon does not appear when the Face Detection function is not activated.)

Face Detection On



Smile Capture



Face Detection Off



The Smile Capture function cannot be set in  (Digital Panorama) mode.



- The Face Detection function cannot be set to off in **AUTO PICT** (Auto Picture), (Night Scene Portrait), (Half-length Portrait), (Portrait), (Kids) or (Natural Skin Tone) mode. You can select either Face Detection On or Smile Capture in these modes.
- Face Detection On is automatically selected in (Green), **AUTO PICT** (Auto Picture), (Night Scene Portrait), (Half-length Portrait), (Movie), (Portrait), (Kids) or (Natural Skin Tone) mode. When switching to another mode from one of these modes, the Face Detection setting returns to the previous setting.

Taking Pictures Automatically (Auto Picture Mode)

In **AUTO PICT** (Auto Picture) mode, the camera automatically selects the most appropriate mode depending on the situations and subjects.

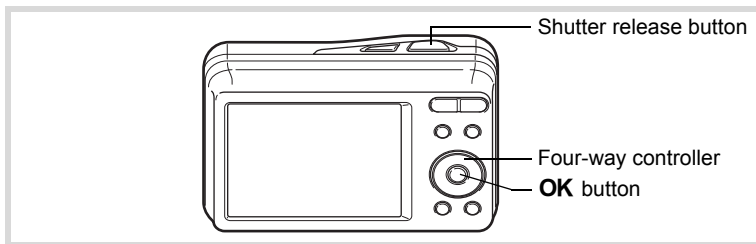

- 1 Press the four-way controller (▼) in mode.**
The Capture Mode Palette appears.
- 2 Use the four-way controller (▲▼◀▶) to select **AUTO PICT**.**
- 3 Press the OK button.**
The **AUTO PICT** (Auto Picture) mode is selected and the camera returns to capture status.
When the camera detects a face, the Face Detection function is activated and the face detection frame appears (p.61).

4 Press the shutter release button halfway.

The focus frame on the display turns green and the selected shooting mode is displayed on the top left of the screen when the camera focuses on the subject at the correct distance.



	Standard		Night Scene		Night Scene Portrait
	Landscape		Flower		Portrait
	Sport		Candlelight		

5 Press the shutter release button fully.

The picture is taken.





The following restrictions apply in **AUTO PICT** mode:

- You cannot turn the Face Detection function off.
- The Focusing Area setting is fixed at [] (Multiple).
- The (Flower) mode cannot be selected when using Digital Zoom or Intelligent Zoom.
- If the (Night Scene) mode is selected when the flash mode is (Auto), the flash mode automatically changes to (Flash Off).
- The camera automatically focuses on the subject when the focus mode is set to **AF** (Standard) or (Macro).

Taking Pictures in the Custom Settings (Program Mode)

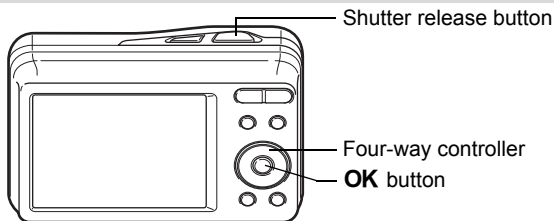
In **P** (Program) mode, the camera automatically sets the shutter speed and aperture for taking still pictures. However, you can select other functions such as the flash mode and recorded pixels.



- 1 Press the four-way controller (▼) in  mode.**
The Capture Mode Palette appears.
- 2 Use the four-way controller (▲▼◀▶) to select .**
- 3 Press the OK button.**

The  (Program) mode is selected and the camera returns to capture status.

When the camera detects a face, the Face Detection function is activated and the face detection frame appears (p.61).



- 4 Set the functions you want to change.**
Refer to "Setting the Shooting Functions" (p.84 - p.92) for details on how to set the functions.
- 5 Press the shutter release button halfway.**
The focus frame on the display turns green when the camera focuses on the subject at the correct distance.
- 6 Press the shutter release button fully.**
The picture is taken.

Taking Pictures in the Basic Mode (Green Mode)

In the **●** (Green) mode, you can enjoy easy picture-taking using standard settings, regardless of the settings in the [📷 Rec.Mode] menu. **●** mode settings are as shown below.

Flash Mode	🔆 (Auto)
Drive Mode	□ (Standard)
Focus Mode	AF (Standard)
Face Detection	On
Information Display	Normal
Recorded Pixels	10M (3648×2736)

Focusing Area	[] (Multiple)
Sensitivity	Auto
EV Compensation	±0.0
Digital Zoom	☑ (On)
Date Imprint	Off

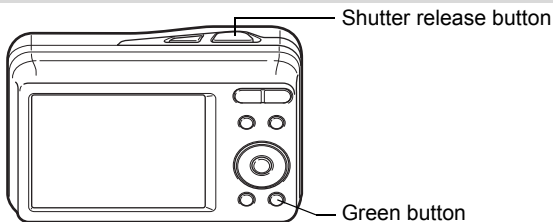

1 Press the Green button in 📷 mode.

The camera switches to **●** mode.

Press the Green button again to return to the status before **● mode was selected.**

When the camera detects a face, the Face Detection function is activated and the face detection frame appears (p.61).



2 Press the shutter release button halfway.

The focus frame on the display turns green when the camera focuses on the subject at the correct distance.

3 Press the shutter release button fully.

The picture is taken.



- In **●** mode, you cannot change the information on the display by pressing the **OK/DISPLAY** button.
- Press the **MENU** button in **●** mode to display the [**Setting**] menu. The [**Rec.Mode**] menu cannot be displayed.
- When the camera is turned off in **●** mode, it turns on in **●** mode next time the power switch is pressed.

Using the Zoom

You can use the zoom to change the captured area.

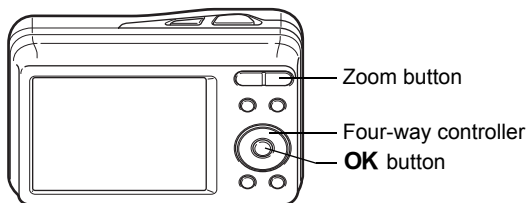

1 Press the Zoom button in **●** mode.

T (Right) enlarges the subject.

W (Left) widens the area that is captured by the camera.

When you press and hold the **T** button, the camera automatically switches from optical zoom to intelligent zoom.

Once the button is released and pressed again, the camera switches to Digital Zoom.

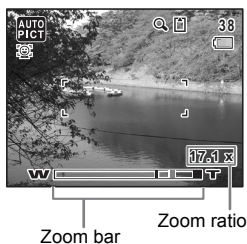

The zoom bar is displayed as follows.

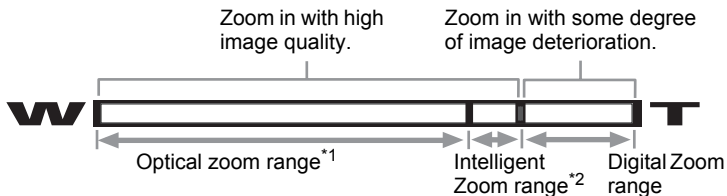

*1 You can zoom in to a maximum of 3× optically.

*2 The Intelligent Zoom range differs depending on the recorded pixels. See the following table.

Recorded pixels and the maximum zoom ratio

Recorded pixels	Intelligent Zoom	Digital Zoom
10M/10M	Not Available (3× optical zoom only)	Equivalent to approx. 17.1×
7M	Approx. 3.5×	
5M	Approx. 4.2×	
3M	Approx. 5.3×	
2.1M16:9	Approx. 5.7×	
2M	Approx. 6.8×	
1024	Approx. 10.7×	
640	Approx. 17.1× (Same as 17.1× Digital Zoom)	



- It is recommended to use a tripod to prevent camera shake when taking pictures at a high magnification rate.
- Pictures taken in the digital zoom range appear grainier than pictures taken in the optical zoom range.
- 2M is available only when shooting panoramic images.
- Intelligent Zoom is not available when the recorded pixels is set to 10M or 10M (3× optical zoom available).
- The image enlarged using Intelligent Zoom may appear rough on the display. This does not affect the quality of recorded image.
- In (Movie) mode, only Digital Zoom is available.



To Set the Digital Zoom

The digital zoom is set to (On) in the default settings. To take pictures using only the optical zoom and Intelligent Zoom, set the digital zoom to (Off).

1 Press the MENU button in  mode.

The [ Rec.Mode] menu appears.

2 Use the four-way controller ( ) to select [Digital Zoom].

3 Use the four-way controller ( ) to select (On) or (Off).

The setting is saved.

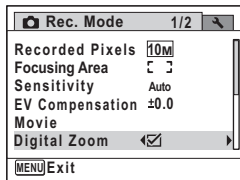





4 Press the MENU button.

The camera returns to capture status.





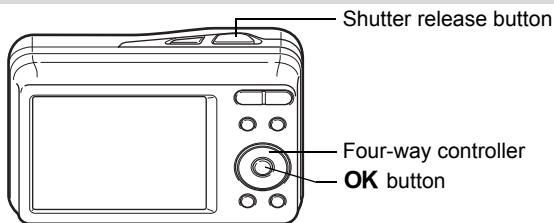

Saving the Digital Zoom Function setting  p.97

Taking Pictures of Dark Scenes (Night Scene/ Night Scene Portrait/Digital SR/Sunset/ Candlelight Mode)

You can choose settings appropriate for taking pictures of dark scenes, such as nightscapes.

	Night Scene	For night time images. Use of a tripod or other support is suggested.
	Night Scene Portrait	For images of people at night. Use of a tripod or other support is advised.
	Digital SR	Higher sensitivity reduces blur.
	Sunset	For images of sunsets and warm lighting.
	Candlelight	For capturing scenes in candlelight.



- 1 Press the four-way controller (▼) in  mode.**
The Capture Mode Palette appears.
- 2 Use the four-way controller (▲▼◀▶) to select , , ,  or .**
- 3 Press the OK button.**
The shooting mode is selected and the camera returns to capture status. When the camera detects a face, the Face Detection function is activated and the face detection frame appears (p.61).
- 4 Press the shutter release button halfway.**
The focus frame on the display turns green when the camera focuses on the subject at the correct distance.

5

Press the shutter release button fully.

The picture is taken.



- The shutter speed tends to be slower when taking pictures of dark scenes.
- To prevent camera shake, use a tripod and/or the self-timer function (p.78).
- In (👤) mode, sensitivity is automatically fixed at Auto.

Taking Pictures of People (Half-length Portrait/Portrait/Natural Skin Tone Mode)

(👤) (Half-length Portrait), (👤) (Portrait) and (👤) (Natural Skin Tone) modes are suitable for taking pictures of people. Face Detection (p.61) operates for each shooting mode, making it easier to emphasize the subject's face when taking pictures.

	Half-length Portrait	For portraits with proper framing by automatic zoom. Fixed at [3M] pixels.
	Portrait	For capturing portraits. Reproduces a healthy and bright skin tone.
	Natural Skin Tone	For images of people. Enhances skin tones while smoothing blemishes.

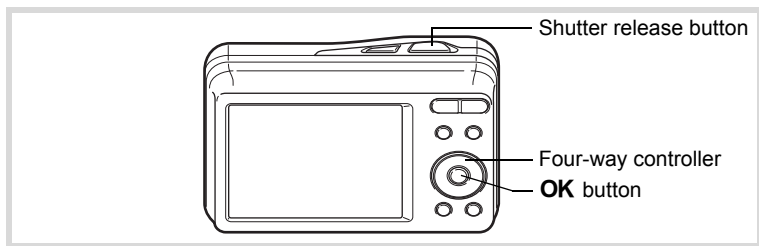

1

Press the four-way controller (▼) in 📷 mode.

The Capture Mode Palette appears.

2 Use the four-way controller (▲▼◀▶) to select , or and press the OK button.

The shooting mode is selected and the camera returns to capture status.

When the camera detects a face, the Face Detection function is activated and the face detection frame appears (p.61).

If the camera detects a person's face in  mode, an orange frame appears showing the area to be zoomed in.



3 Press the shutter release button halfway.

The focus frame on the display turns green when the camera focuses on the subject at the correct distance.

If the camera detects a person's face in  mode, the camera automatically zooms in to enlarge the area in the orange frame shown in Step 2.

4 Press the shutter release button fully.

The picture is taken.

Taking Pictures of Children (Kids Mode)

 (Kids) mode is suitable for taking pictures of moving children. It also reproduces a healthy and bright skin tone. Face Detection (p.61) operates automatically for this mode, making it easier to emphasize the subject's face when taking pictures.

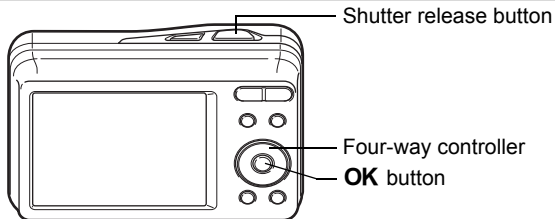

1 Press the four-way controller (▼) in mode.

The Capture Mode Palette appears.

2 Use the four-way controller (▲▼◀▶) to select .

3 Press the OK button.

The  (Kids) mode is selected and the camera returns to capture status.

When the camera detects a face, the Face Detection function is activated and the face detection frame appears (p.61).



4 Press the shutter release button halfway.

The focus frame on the display turns green when the camera focuses on the subject at the correct distance.

5 Press the shutter release button fully.

The picture is taken.

Taking Pictures of Your Pet (Pet Mode)

Use this mode to keep your moving pet in focus while you take the picture and capture the color of your pet's coat. Choose the appropriate icon depending on what color your pet is (closer to black or white or in between).

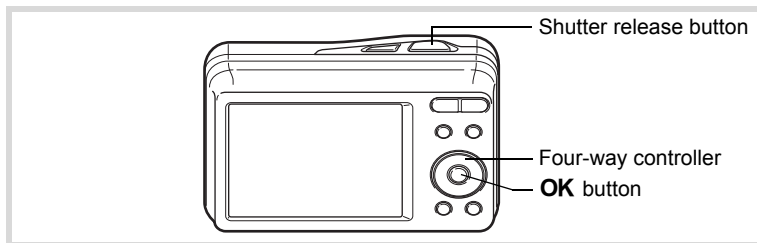

1 Press the four-way controller (▼) in  mode.

The Capture Mode Palette appears.

2 Use the four-way controller (▲▼◀▶) to select .

3 Press the OK button.

The Pet mode selection screen appears.

4 Use the four-way controller (▲▼) to select , , , , or .

There are two types of icons: a cat and dog icon. Choosing either the cat or dog icon does not affect the resulting picture. Choose whichever you prefer.

Choose an icon (white, gray, or black) whose tone best matches your pet's coat or fur.



5 Press the OK button.

The Pet mode is selected and the camera returns to capture status.

When the camera detects a person's face, the Face Detection function is activated and the face detection frame appears (p.61).



6 Press the shutter release button halfway.



The focus frame on the display turns green when the camera focuses on the subject at the correct distance.

The focus frame follows the subject while the shutter release button is pressed halfway.

7 Press the shutter release button fully.

The picture is taken.

Taking Pictures of Sports and Leisure Activities (Surf & Snow/Sport Mode)

	Surf & Snow	For bright images such as sand or snow. Accurately meters for bright scenes.
	Sport	For a fast moving subject. Tracks the subject until the picture is taken.

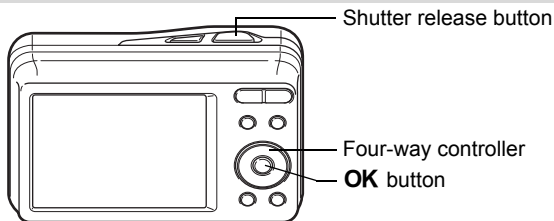

1 Press the four-way controller (▼) in  mode.

The Capture Mode Palette appears.

2 Use the four-way controller (▲▼◀▶) to select  or .

3 Press the OK button.

The shooting mode is selected and the camera returns to capture status.

When the camera detects a face, the Face Detection function is activated and the face detection frame appears (p.61).



4 Press the shutter release button halfway.

The focus frame on the display turns green when the camera focuses on the subject at the correct distance.

When the Sport mode is selected, the focus frame follows the subject while the shutter release button is pressed halfway.



5 Press the shutter release button fully.

The picture is taken.

Framing Your Pictures (Frame Composite Mode)

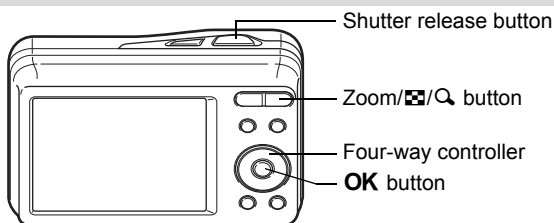



In  (Frame Composite) mode, you can take pictures using the frames stored in the camera.

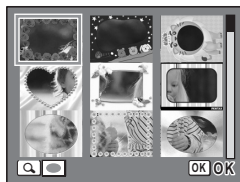

- 1 Press the four-way controller (▼) in  mode.**
The Capture Mode Palette appears.
- 2 Use the four-way controller (▲▼◀▶) to select  and press the OK button.**
A 9-frame display of the frame selection screen appears.

- 3 Use the four-way controller (▲▼◀▶) to choose the frame you want to use.**



- 4 Press  on the Zoom//Quick button.**
The selected frame appears in single-image display.
You can choose another frame using either of the following operations.
 - Four-way controller (◀▶) Press to choose a different frame.
 - Zoom//Quick button () Press to return to the 9-frame display of the frame selection screen, and then perform Step 3 to choose a different frame.

5 Press the OK button.

The frame appears on the display. When the camera detects a face, the Face Detection function is activated and the face detection frame appears (p.61).





6 Press the shutter release button halfway.

The focus frame on the display turns green when the camera focuses on the subject at the correct distance.

7 Press the shutter release button fully.

The picture is taken.



- In  mode, recorded pixels is fixed at  (2048 × 1536).
- At shipment, the camera includes 3 default frames and 17 optional frames built-in. (The CD-ROM supplied with the camera contains a total of 20 frames, including the default frames.)

Optional Frames



The optional frames are stored in the built-in memory in the Optio E90. These optional frames are deleted if the built-in memory is formatted or if the built-in memory files are deleted with a computer. To reload the optional frames into the built-in memory, copy the files from the CD-ROM (S-SW104) supplied with the camera (p.132).

Adding a Frame to a captured image  p.129

Using the Self-timer

In Self-timer mode, the picture is taken ten seconds or two seconds after the shutter release button is pressed.

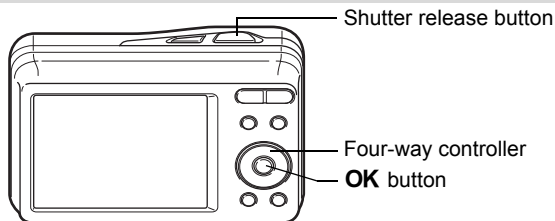

Stabilize the camera with a tripod when taking a picture with the self-timer.

	Use this mode when you want to be included in a group picture. The picture is taken approximately ten seconds after the shutter release button is pressed.
	Use this mode to avoid camera shake. The picture is taken approximately two seconds after the shutter release button is pressed.



3

1 Press the four-way controller (▲) in  mode.

2 Use the four-way controller (◀▶▼) to select  or  and press the OK button.

The camera is ready to take the picture using the self-timer.



When the camera detects a face, the Face Detection function is activated and the face detection frame appears (p.61).



3 Press the shutter release button halfway.

The focus frame on the display turns green when the camera focuses on the subject at the correct distance.

4 Press the shutter release button fully.

When set to , the self-timer lamp lights. The self-timer lamp blinks during the last 3 seconds before shooting or when set to .

The picture is taken ten seconds or two seconds later.



- Focusing may be compromised if you move the camera while the self-timer lamp is blinking when taking still pictures.
- The self-timer lamp does not light up or blink in (Pet) mode.



- In (Movie) mode, recording will start after ten seconds (or two seconds).
- Press the shutter release button halfway while the self-timer is engaged to stop the countdown and press fully to restart the countdown.
- cannot be selected while (Green) mode is in default setting. Select in another shooting mode and then switch the shooting mode to .

Taking a Series of Pictures (Continuous Shooting/16-frame Shooting Mode)

In these modes, pictures are taken continuously as long as the shutter release button is pressed.

	Continuous Shooting	Each time a picture is taken, the image is saved in the memory before the next image is taken. The higher the image quality, the longer the interval between shots.
	16-frame shooting	16 pictures are taken continuously at 1/7.5 second intervals.

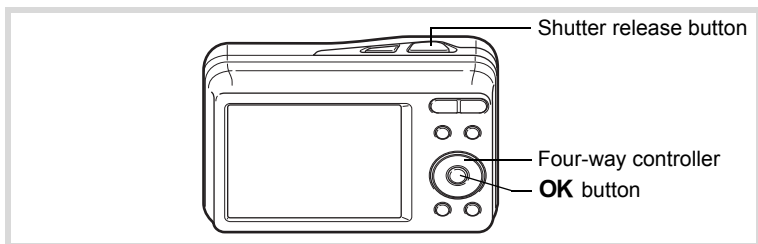

1 Press the four-way controller () in mode.

2 Use the four-way controller () to select or and press the **OK** button.

The camera is ready to take a series of pictures.



3

Press the shutter release button halfway.

The focus frame on the display turns green when the camera focuses on the subject at the correct distance.













4

Press the shutter release button fully.







In  mode, pictures are taken continuously as long as you keep the shutter release button pressed.

In  mode, 16 pictures are taken continuously with one press of the shutter release button.

Caution

- The flash does not discharge in  or  mode.
-  and  cannot be selected in  (Green),  (Auto Picture),  (Night Scene),  (Movie),  (Frame Composite) or  (Digital Panorama) mode.  cannot be selected in  (Half-length Portrait) or  (Digital SR) mode.

memo

- The focus and exposure are locked with the first shot.
- When the Face Detection is activated (p.61), it works only when taking the first shot.
- In  mode, pictures are taken with the following settings.
 - Sensitivity is fixed at Auto.
 - EV Compensation and Auto Focus are adjusted when taking the first picture and are fixed for subsequent pictures.
 - The flash is not available (Ⓢ appears).
 - The last shot taken is displayed in Instant Review.
- In  mode, the recorded pixels is fixed at  (640×480) per one frame and will be saved as a single image in 4 × 4 rows of the 16 images with the recorded pixels of  (2560×1920).
- When you play back the images taken with  mode, they will be displayed as follows.
 - When played back on this camera, 16 images are continuously played back like a movie. You can save one of a series of images taken with  mode as a single image. The available operations during playback are the same as when playing back the movies. (p.101)
 - When played back on a computer, the 16 images are arranged in 4 × 4 rows and displayed as a single image.

Taking Panoramic Pictures (Digital Panorama Mode)

In **■** (Digital Panorama) mode, you can stitch two or three captured frames to create a panoramic photograph with the camera.

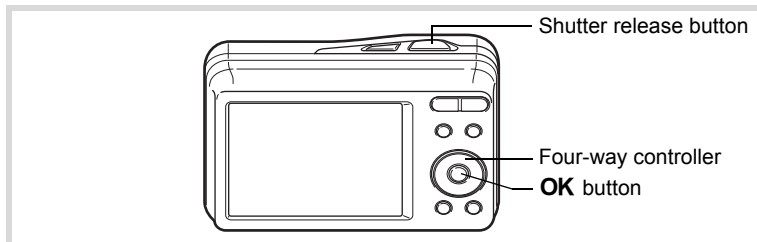

- 1 Press the four-way controller (▼) in mode.**
The Capture Mode Palette appears.
- 2 Use the four-way controller (▲▼◀▶) to select .**
- 3 Press the OK button.**
The camera enters the mode and the message [Set shift direction] is displayed.
- 4 Use the four-way controller (◀▶) to choose the direction in which the images will be joined.**
The screen for taking the first frame is displayed.



When the camera detects a face, the Face Detection function is activated and the face detection frame appears (p.61).



5 Press the shutter release button halfway.

The focus frame on the display turns green when the camera focuses on the subject at the correct distance.

6 Press the shutter release button fully.

The screen for taking the second frame is displayed after you take the first frame.

If you select right (▶) in Step 4:

The right edge of the first frame appears in semi-transparent form on the left edge of the display.

If you select left (◀) in Step 4:

The left edge of the first frame appears in semi-transparent form on the right edge of the display.

7 Move the camera so that the alignment icons for the semi-transparent image and the actual view overlap.

The shutter is automatically released when the icons overlap.

If the actual view is not aligned with the semi-transparent image, an arrow indicating the direction the camera must be moved (either up or down) appears.

If the shutter is not released automatically, press the shutter release button to take the picture.

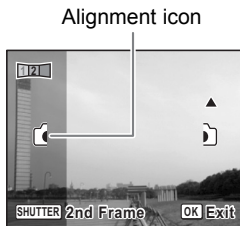

8 Take the third frame.

Repeat Step 7 to take the third frame.

The panorama stitching starts and a stitched image appears.



- Some distortion may result from moving objects, repeating patterns, or if nothing exists when overlapping the first and second frames or the second and third frames on the preview guide.
- When the Face Detection is activated (p.61), it works only when taking the first frame. The Smile Capture function cannot be set.

- 1** After shooting the first frame in Step 6 or second frame in Step 7, press the **OK** button or the four-way controller (**▼**).

A confirmation dialog appears.

- 2** Use the four-way controller (**▲▼**) to select an option and press the **OK** button.

- Save:** Saves the captured image(s) and you can retake the first frame. When this option is selected after shooting the second frame, the first and the second frames are stitched and saved as a panoramic photograph.
- Discard:** Discards the captured image(s) and you can retake the first frame.
- Cancel:** Returns to the previous shooting screen.

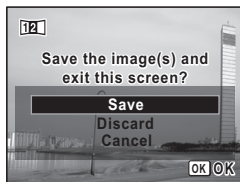

Setting the Shooting Functions

Selecting the Flash Mode

	Auto	The flash discharges automatically depending on the light conditions.
	Flash Off	The flash does not discharge, regardless of the brightness. Use this mode to take pictures where flash photography is prohibited.
	Flash On	The flash discharges regardless of the brightness.
	Flash On + Red-eye	This mode reduces the phenomenon of red eyes caused by the light from the flash being reflected in the subject's eyes. The flash discharges regardless of the light conditions.



- The flash does not discharge () in (Movie) mode, or when the drive mode is set to (Continuous Shooting) or (16-frame shooting), or the focus mode is set to (Infinity).
- A pre-flash discharges when using the red-eye reduction function.
- In (Green) mode, you can only select or .
- In (Night Scene) mode, you cannot select .
- In (Night Scene Portrait) mode, or when the Face Detection is set to On and the flash is set to , the flash mode will automatically change to when a face is detected.



Using the flash when capturing images at a close distance may cause uneven exposure of the image due to the light distribution.

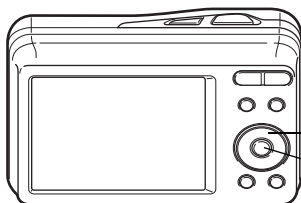

Four-way controller
OK button

1 Press the four-way controller (◀) in mode.

The flash mode changes each time the button is pressed. You can also change the setting using the four-way controller (▲▼).

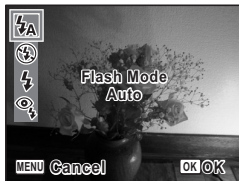

2 Press the OK button.

The setting is saved and the camera returns to capture status.



About the red-eye phenomenon

Taking pictures using the flash may cause the subject's eyes to appear red in the resulting picture. This phenomenon occurs when the light from the flash is reflected in the subject's eyes. It can be reduced by illuminating the area around the subject or moving closer to the subject and zooming out to a wider angle. Setting the flash mode to  (Flash On + Red-eye) is also an effective way of reducing red eyes.

If the subject's eyes appear red despite such precautions, they can be corrected by the red-eye compensation function (p.128).

Saving the Flash Mode setting  p.97

Selecting the Focus Mode

AF	Standard	Use this mode when the distance to the subject is 50 cm (16 in.) or more. The camera is focused on the subject in the autofocus area when the shutter release button is pressed halfway.
	Macro	This mode is used when the distance to the subject is approx. 10 cm to 60 cm (4 in. to 20 in.). The camera is focused on the subject in the autofocus area when the shutter release button is pressed halfway.
PF	Pan Focus	This mode is used when you ask someone to take pictures for you, or when taking pictures of the scenery through the window of a car or train. The entire picture, from the front to the back, is focused.
	Infinity	This mode is used for taking distant objects. The flash is set to  (Flash Off).

1 Press the four-way controller (▶) in mode.



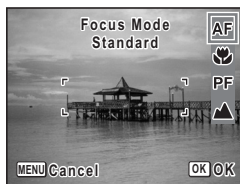

The focus mode changes each time the button is pressed. You can also change the setting using the four-way controller (▲▼).



2 Press the OK button.

The setting is saved and the camera returns to capture status.



- In  (Green) mode, you can only select **AF**, , or **PF**.
- When **AF** (Standard) is selected and the subject is closer than 50 cm, the camera automatically focuses from 10 cm (Auto-Macro function). In this case,  appears on the display.
- When shooting with  selected, if the subject is further than 60 cm away, the camera automatically focuses to ∞ (Infinity).
- When shooting with  selected, even if the subject is not in focus, the camera is able to shoot the image. In this case, a blurred image will be shot.

Saving the Focus Mode setting  p.97

To Set the Focusing Area

You can change the autofocus area (Focusing Area).

	Multiple	Normal autofocus area
	Spot	The autofocus area becomes smaller.
	Automatic Tracking AF	Keeps moving subjects in focus.

- 1 Press the MENU button in mode.**
The [Rec.Mode] menu appears.
 - 2 Use the four-way controller () to select [Focusing Area].**
 - 3 Press the four-way controller ().**
A pull-down menu appears.
 - 4 Use the four-way controller () to change the Focusing Area setting.**
- Rec. Mode 1/2

Recorded Pixels 10M

Focusing Area

Sensitivity

EV Compensation

Movie

Digital Zoom

MENU Cancel OK OK
- 5 Press the OK button.**
The setting is saved.
 - 6 Press the MENU button.**
The camera returns to capture status.



- In (Movie) and (Frame Composite) modes, the Focusing Area cannot be set to .
- In (Green) and (Auto Picture) modes, the Focusing Area is fixed at .

Selecting the Recorded Pixels

You can choose from eight recorded pixels settings for still pictures. The larger your recorded pixels, the clearer the details will appear when you print your picture. As the quality of the printed picture also depends on the image quality, exposure control, resolution of the printer and other factors, you do not need to select more than the required number of recorded pixels. **3M** (2048×1536) is adequate for making postcard-size prints. The more pixels there are, the larger the picture and the bigger the file size. (**10M** is higher in quality than **10M**)

3

Refer to the following table for the appropriate settings according to use.

Recorded Pixels	Use
10M 3648×2736	↑ Clearer For printing high quality photos or A4-size pictures or larger, or editing images on a computer. For making postcard-size prints. For a natural feeling of expansiveness with the same aspect ratio as HDTV. For posting on a website or attaching to e-mail.
10M 3648×2736	
7M 3072×2304	
5M 2592×1944	
3M 2048×1536	
2.1M16:9 1920×1080 (16 : 9)	
1024 1024× 768	
640 640× 480	

The default setting is **10M** (3648×2736).

Shooting/Playback screen when

2.1M16:9 is selected

If you select **2.1M16:9** as the Recorded Pixels setting, the aspect ratio of the image is 16:9 and the monitor display is as shown on the right.



1 Press the MENU button in mode.

The [ Rec.Mode] menu appears.

2 Use the four-way controller (▲▼) to select [Recorded Pixels].

3 Press the four-way controller (▶).
A pull-down menu appears.

4 Use the four-way controller (▲▼) to change the number of recorded pixels.

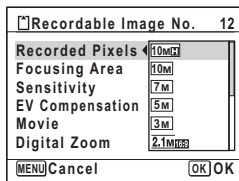

5 Press the OK button.
The setting is saved.

6 Press the MENU button.
The camera returns to capture status.









- The number of recorded pixels for images captured in ● (Green) mode is fixed at 10M.
- The number of recorded pixels for images captured in 📷 (Half-length Portrait) or 📷 (Frame Composite) is fixed at 3M.
- The number of recorded pixels for images captured in Digital Panorama mode is fixed at 2M (1600×1200).
- The number of recorded pixels for images captured with 📷 (16-frame shooting) is fixed at 640 for one frame and 5M (2560×1920) for one image.

Setting the Exposure (EV Compensation)

You can adjust the overall brightness of the picture.

Use this function to take pictures that are intentionally overexposed or underexposed.

- 1 **Press the MENU button in  mode.**
The [ Rec.Mode] menu appears.
- 2 **Use the four-way controller ( ) to select [EV Compensation].**
- 3 **Use the four-way controller ( ) to select the EV value.**

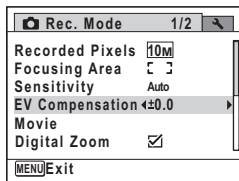

To brighten, select a positive (+) value. To darken, select a negative (-) value. You can choose the EV setting in the range of -2.0 EV to +2.0 EV in 1/3 EV steps.



- 4 **Press the MENU button.**

The camera returns to capture status.



The EV compensation function cannot be used in  (Green) or  (Auto Picture) mode.

Saving the EV Compensation value setting  p.97

Setting the Sensitivity

You can select the sensitivity to suit the brightness of the surroundings.

Auto	The sensitivity is automatically adjusted by the camera. (Sensitivity 100 - 800)
100	 <p>The lower the sensitivity, the less noise that affects the image. The shutter speed will be slower in low light conditions.</p> <p>Higher sensitivity settings use faster shutter speeds in low light conditions to reduce camera shake, but the image may be affected by noise.</p>
200	
400	
800	
1600	

1 Press the MENU button in mode.

The [ Rec.Mode] menu appears.

2 Use the four-way controller () to select [Sensitivity].

3 Press the four-way controller () .

A pull-down menu appears.

4 Use the four-way controller () to change the sensitivity.

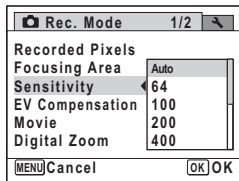



5 Press the OK button.

The setting is saved.

6 Press the MENU button.

The camera returns to capture status.



- When set to  (Green) or  (Movie) mode, only Auto (sensitivity 100 - 800) is available.
- When set to  (Digital SR) mode, only Auto (sensitivity 100 - 1600) is available.

Saving the sensitivity setting  p.97

Setting the Date Imprint Function

You can choose whether to imprint the date and/or time when taking still pictures.

1 Press the **MENU** button in mode.

The [ Rec.Mode] appears.

2 Use the four-way controller () to select [Date Imprint].

3 Press the four-way controller ().

A pull-down menu appears.

4 Use the four-way controller () to select the Date Imprint details.

Choose from [Date], [Date & Time], [Time] or [Off].

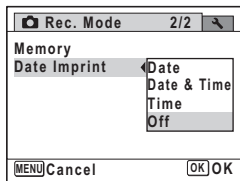

5 Press the **OK** button.

The setting is saved.

6 Press the **MENU** button.

The camera returns to capture status.



- **DATE** appears on the display in  mode when [Date Imprint] is set.
- The date and/or time imprinted with the Date Imprint function cannot be deleted.
- The date and/or time are imprinted on the picture with the display style set in the [Date Adjustment] screen (p.41).
- Note that if the printer or the image editing software is set to print the date and the images to be printed already have the date and/or time imprinted, the imprinted dates and/or times may overlap.

Recording Movies

Recording a Movie

This mode enables you to record movies. Sound is recorded at the same time.

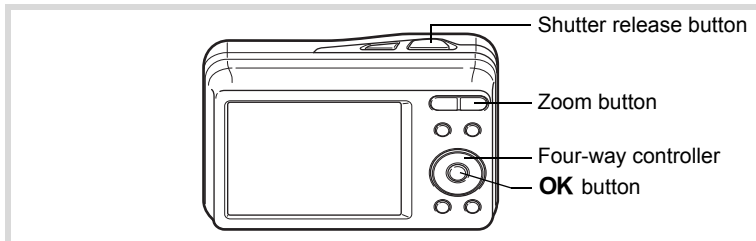

1 Press the four-way controller (▼) in mode.

The Capture Mode Palette appears.

2 Use the four-way controller (▲▼◀▶) to select (Movie).



3 Press the OK button.

(Movie) mode is selected and the camera returns to capture status.

The following information appears on the display.

- 1 Movie mode icon
- 2 Recording indicator (blinks during recording)
- 3 Remaining recordable time
- 4 Focus frame (does not appear during recording)
- 5 Movie shake reduction function icon

You can change the captured area by pressing the Zoom button to the left or right.

T (Right) enlarges the subject.

W (Left) widens the area that is captured by the camera.

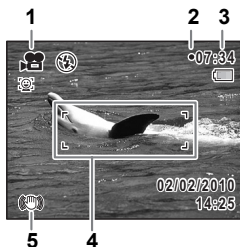

4 Press the shutter release button fully.

Recording starts. You can continue recording until the built-in memory or the SD Memory Card is full, or the size of the recorded movie reaches 2 GB.



- The flash does not discharge in (Movie) mode.
- The focus mode can be changed before recording starts.
- You can use the optical zoom only before recording, while the digital zoom is available both before and during recording.
- When the shooting mode is set to (Movie), Face Detection is automatically set to on. You can select Smile Capture or Face Detection Off by pressing the button before you start recording a movie (p.61). When the Smile Capture function is activated, movie recording starts automatically when the camera detects the subject's smile. However, depending on the condition of the detected faces, movie recording may not start automatically because the Smile Capture function may not work. In this case, press the shutter release button to start movie recording.

5 Press the shutter release button fully.

Recording stops.

Playing Back a Movie p.101





Keeping the Shutter Release Button Pressed

If you keep the shutter release button pressed for more than one second, recording will continue as long as you keep the button pressed. Shooting stops when you take your finger off the shutter release button.











Selecting the Recorded Pixels for Movies

You can choose from four recorded pixels settings for movies: , , and .

The more pixels there are, the clearer the details and the bigger the file size. 30fps will give smoother movies than 15fps, but file size will increase.

 (640×480, 30fps),  (640×480, 15fps)	Suitable for viewing on a TV or computer screen.
 (320×240, 30fps),  (320×240, 15fps)	Suitable for posting on a website or attaching to e-mail.

The default setting is  (640×480, 30fps).

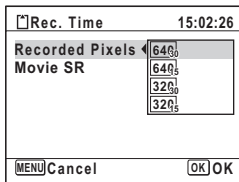

- 1 Press the MENU button in  mode.**
The [ Rec.Mode] menu appears.
- 2 Use the four-way controller ( ) to select [Movie].**
- 3 Press the four-way controller ().**
The [Movie] screen appears.
- 4 Use the four-way controller ( ) to select [Recorded Pixels].**
- 5 Press the four-way controller ().**
A pull-down menu appears.
- 6 Use the four-way controller ( ) to change the number of recorded pixels.**



- 7 Press the OK button.**
The setting is saved.
- 8 Press the MENU button twice.**
The camera returns to capture status.

Setting the Movie SR (Movie Shake Reduction) Function

In  (Movie) mode, you can compensate for camera shake while you are recording a movie with the Movie SR (Movie Shake Reduction) function.

- 1 Press the MENU button in  mode.**
The [ Rec.Mode] menu appears.
- 2 Use the four-way controller (▲▼) to select [Movie].**
- 3 Press the four-way controller (▶).**
The [Movie] screen appears.
- 4 Use the four-way controller (▲▼) to select [Movie SR].**
- 5 Use the four-way controller (◀▶) to select (On) or (Off).**
The setting is saved.
- 6 Press the MENU button twice.**
The camera returns to capture status.

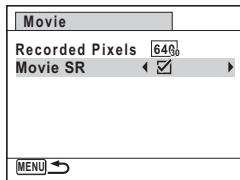

Saving the Settings (Memory)

The Memory function is for saving the current camera settings when the camera is turned off.

For some camera settings, the Memory function is always set to (On) (the settings are saved when the camera is turned off), while for others you can choose on or off (to choose whether the settings are saved or not when the camera is turned off). The items which can be set to (On) or (Off) in the Memory function are shown in the table below. (Items not listed here are always saved in the selected settings when the camera is turned off.)

If you select (On), the settings will be saved in the status they were in immediately before the camera was turned off. If you select (Off), the settings will be reset to the defaults when the camera is turned off. The table below also shows whether the Memory default setting for each item is on or off.

Item	Description	Default Setting	Page
Face Detection	The Face Detection mode set with the [Ⓜ] button.	<input type="checkbox"/>	p.61
Flash Mode	The flash mode set with the four-way controller (◀)	<input checked="" type="checkbox"/>	p.84
Drive Mode	The drive mode set with the four-way controller (▲)	<input type="checkbox"/>	p.78 p.79
Focus Mode	The focus mode set with the four-way controller (▶)	<input type="checkbox"/>	p.86
Zoom Position	The zoom position set with the Zoom button	<input type="checkbox"/>	p.67
Sensitivity	The [Sensitivity] setting on the [📷 Rec.Mode] menu	<input type="checkbox"/>	p.90
EV Compensation	The [EV Compensation] setting on the [📷 Rec.Mode] menu	<input type="checkbox"/>	p.90
Digital Zoom	The [Digital Zoom] setting on the [📷 Rec.Mode] menu	<input checked="" type="checkbox"/>	p.69
DISPLAY	The information display mode set with the OK/DISPLAY button	<input type="checkbox"/>	p.18
File No.	If a new SD Memory Card is inserted when On has been selected, file numbers are assigned sequentially.	<input checked="" type="checkbox"/>	—

1 Press the **MENU** button in **📷** mode.

The [📷 Rec.Mode] menu appears.

2 Use the four-way controller (▲▼) to select [Memory].

3 Press the four-way controller (▶).

The [Memory] screen appears.

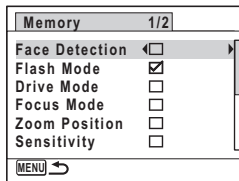
4 Use the four-way controller (▲▼) to choose an item.

5 Use the four-way controller (◀▶) to select (On) or (Off).

6 Press the **▶** button or the shutter release button.

The camera returns to capture status.

4 Playing Back and Deleting Images

Playing Back Images	100
Deleting Images	111
Connecting the Camera to AV Equipment	119

Playing Back Images

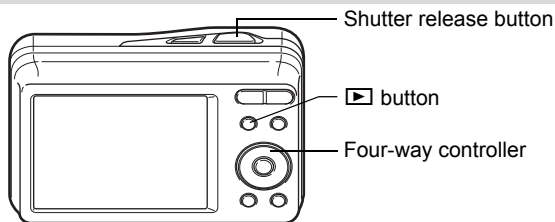

Playing Back Still Pictures



4

Playing Back and Deleting Images

1 Press the button after taking a picture.

The camera enters the  mode and the image appears on the display. Displaying one image in full in  mode ( mode default setting) is called single-image display.

File number





To Play Back the Previous or Next Image

2 Press the four-way controller ().

The previous or next image appears.

To Delete the Displayed Image

Press the  button while the image is displayed to display the Delete screen. Press the four-way controller () to select [Delete] and press the **OK** button.





For information on other deletion procedures  p.111

Playing Back a Movie

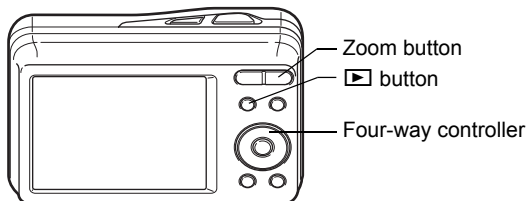
You can play back the movies you have taken. Sound is played back at the same time. You can also play back images taken with  (16-frame shooting) mode in the same way as you play back movies.







1 Enter the  mode and use the four-way controller ( ) to choose the movie you want to play back.





2 Press the four-way controller (). Playback starts.



The following operations can be performed during playback.

- Four-way controller () Plays back in reverse
- Four-way controller () Pauses playback
- Four-way controller () When pressed and held:
Plays back in reverse fast-forward (10×)
- Four-way controller () When pressed and held:
Plays back in fast-forward (10×)
- Zoom button (Right) Increases the volume
- Zoom button (Left) Reduces the volume

The following operations can be performed while playback is paused.

- Four-way controller () Reverses the playback one frame at a time.
- Four-way controller () Forwards the playback one frame at a time.
- Four-way controller () Resumes playback
- Green button Saves the paused frame of a series of images taken with  (16-frame shooting) mode as a single image in  (640×480) pixels.



To cancel playing back in fast-forward, press and hold four-way controller (▶), and to cancel playing back in reverse fast-forward, press and hold four-way controller (◀). The camera returns to either playback in reverse or normal playback.

3 Press the four-way controller (▼).

Playback stops.

Four-Image Display, Nine-Image Display, Folder Display and Calendar Display

Four-Image/Nine-Image Display

4

You can display four or nine thumbnails of captured images at a time.

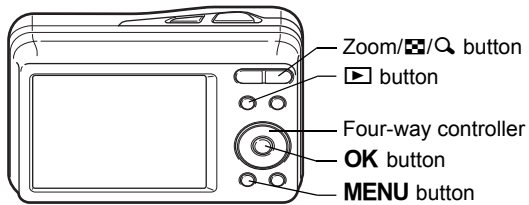

1 In Play mode, press Matrix on the Zoom/Matrix/Quick button.

A page consisting of four thumbnail images appears. The displayed images change four at a time page by page. Press Matrix again to display a page consisting of nine-thumbnail images. The displayed images change nine at a time page by page as well. Press Quick on the Zoom/Matrix/Quick button to return to single-image display from four-image display, and to four-image display from nine-image display.

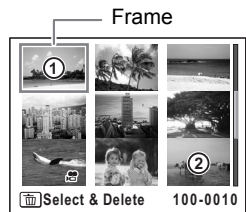

Use the four-way controller (▲▼◀▶) to move the frame. When five or more images have been saved for four-image display or 10 or more images have been saved for nine-image display, if you choose image ① and press the four-way controller (▲◀), the previous page appears. Similarly, if you choose image ② and press the four-way controller (▼▶), the next page appears.





The icons that appear on the images indicate the following:

- | | |
|---|---------------------------------|
| (No icon) | Still picture |
|  | Movie (the first frame appears) |

Press the **OK** button or the **MENU** button to switch to single-image display of the selected image.

Press the  button or the shutter release button to switch to  mode.

To Switch to Folder Display or Calendar Display

In nine-image display, press  on the Zoom//Q button to switch to folder display or calendar display. Press the Green button to switch between folder display and calendar display.

1 In mode, press on the Zoom//Q button.





The screen changes to four-image display. Press  again to change the screen to nine-image display.



2 Press on the Zoom//Q button.

The screen changes to folder display or calendar display.

Folder display

The list of folders with recorded images appears.

Use the four-way controller (   ) to move the frame.



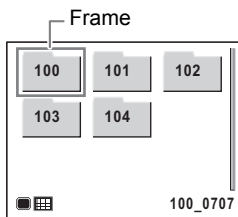

Press the **OK** button or  on the Zoom// button to display the images in the selected folder in nine-image display.





Calendar display

Recorded images are displayed by date in calendar format.

The first image recorded on a date is displayed for that date on the calendar.

Use the four-way controller (   ) to move the frame to a different date.

Press  on the Zoom// button to display the images for a date in nine-image display.

Select a date and press the **OK** button to switch to single-image display of the first image recorded on that date.

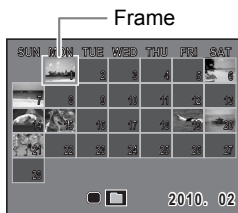



- Press the **MENU** button in folder display or calendar display to switch to nine-image display.
- Press the button or half-press the shutter release button in folder display or calendar display to switch to mode.

Using the Playback Function

Press the four-way controller () in mode to display the Playback Mode Palette.

You can display the playback function you want to use simply by using the four-way controller (, , ,) to choose an icon and pressing the **OK** button.

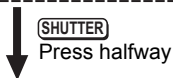
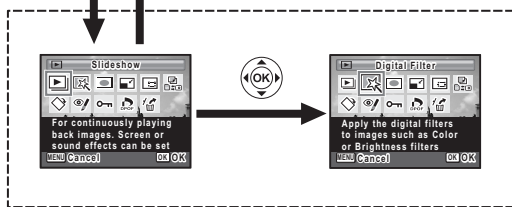
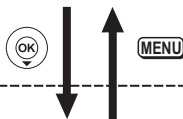

Closes the Playback Mode Palette and goes to mode.













Goes to the screen for selected playback function.











When an icon is selected in the Playback Mode Palette, a guide for the selected function appears.

Playback Mode Palette

Playback Mode	Description	Page
 Slideshow	For continuously playing back images. Screen or sound effects can be set.	p.106
 Digital Filter	Apply the digital filters to images such as Color or Brightness filters.	p.125
 Frame Composite	For composing an image with a frame. Select Overwrite or Save as to save.	p.129
 Resize	Changes Recorded Pixels and Quality Level to make the file size smaller.	p.122
 Cropping	For cropping images to the size you like. Saved as a new image.	p.123
 Image Copy	To copy images between the built-in memory and an SD Memory Card.	p.133
 Image Rotation	Rotates captured images. Useful when viewing vertical images on a TV.	p.108
 Red-eye Compensation	For compensating red-eye. May not work due to the condition of the image.	p.128
 Protect	Protects images from delete function. Format function still erases all.	p.116
 DPOF	For the print settings. Useful when printing at a printing service.	p.135
 Image Recovery	For recovering images which were accidentally deleted.	p.115

Slideshow

You can play back recorded images one after another.







- 1** Enter the  mode and use the four-way controller ( ) to choose an image to start the slideshow with.
- 2** Press the four-way controller ().
The Playback Mode Palette appears.
- 3** Use the four-way controller (   ) to select  (Slideshow).



- 4** Press the **OK** button twice.
The slideshow starts.
Pressing the **OK** button during the slideshow pauses the slideshow. To resume the slideshow, press the **OK** button again.
- 5** Press any button other than the **OK** button.
The slideshow stops.

To Set the Slideshow Conditions

You can set the playback interval and also a screen effect and sound effect for when one image changes to the next.

- 1** Press the four-way controller () in  mode.
The Playback Mode Palette appears.
- 2** Use the four-way controller (   ) to select  (Slideshow).
- 3** Press the **OK** button.
The screen for setting the slideshow conditions appears.

- 4** Use the four-way controller (▲▼) to select [Interval].

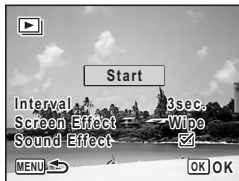

- 5** Press the four-way controller (▶).

A pull-down menu appears.

- 6** Use the four-way controller (▲▼) to change the interval and press the OK button.

Choose from [3sec.], [5sec.], [10sec.], [20sec.] or [30sec.].

- 7** Use the four-way controller (▲▼) to select [Screen Effect].

After selecting [Screen Effect], press the four-way controller (▶). A pull-down menu appears with the following items. Use the four-way controller (▲▼) to select an item and press the OK button.

Wipe	The next image slides over the previous one from left to right
Checker	The next image appears in small square mosaic blocks
Fade	The current image gradually fades out and the next image fades in
Off	No effect

- 8** Use the four-way controller (▲▼) to select [Sound Effect].

- 9** Use the four-way controller (◀▶) to select (On) or (Off).

Except when the [Screen Effect] is set to Off, you can choose (On) or (Off) for the sound that is played when one image changes to the next.

- 10** Use the four-way controller (▲▼) to select [Start] and press the OK button.

The slideshow starts using the selected interval and effect.



- The slideshow will continue until you press any button other than the **OK** button.
- Movies will normally be played through to the end before the next picture is played back, regardless of the interval setting. However, pressing the four-way controller (▶) while playing back a movie skips to the next image.
- Panorama images will be scrolled for display from left to right in 4 seconds before the next picture is played back, regardless of the settings of [Interval] or [Screen Effect].

Connecting the Camera to AV Equipment p.119

4

Rotating the Image

1 Press the button after taking a picture.

The image appears on the display.

2 Press the four-way controller (▼).

The Playback Mode Palette appears.

3 Use the four-way controller (▲▼◀▶) to select (Image Rotation) and press the **OK** button.

The rotation selection screen (0°, Right 90°, Left 90°, or 180°) appears.

4 Use the four-way controller (▲▼◀▶) to choose the rotation direction and press the **OK** button.

The rotated image is saved.

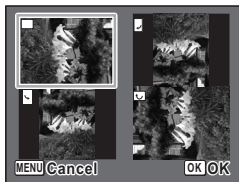

- Panoramic images, images taken with (16-frame shooting) mode and movies cannot be rotated.
- Protected images can be rotated, but they cannot be saved in a rotated state.

Zoom Playback

You can magnify an image up to ten times.

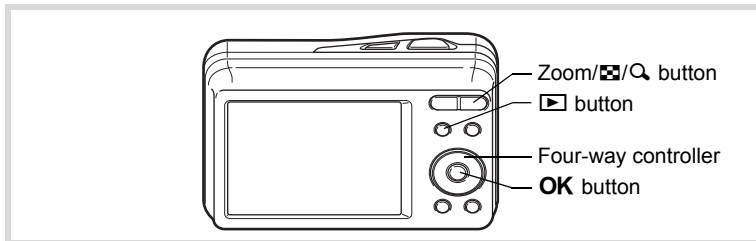

1 Enter the  mode and use the four-way controller ( ) to choose the image you want to magnify.







2 Press  on the Zoom/Zoom In/Zoom Out button.

The image is magnified ($\times 1.1$ to $\times 10$). Holding down  on the Zoom/Zoom In/Zoom Out button changes the magnification continuously. You can use the + mark of the guide at the bottom left of the screen to check which portion of the image is magnified.



Guide

The following operations can be performed while the magnified image is displayed.

- | | |
|---|--|
| Four-way controller (   ) | Moves the position to be magnified |
| Zoom/Zoom In/Zoom Out button () | Makes the image bigger (max. $\times 10$) |
| Zoom/Zoom In/Zoom Out button () | Makes the image smaller (min. $\times 1.1$) |

3 Press the OK button.



The image returns to single-image display.





Images taken with  (16-frame shooting) mode and movies cannot be magnified.

Zoom In on the Subject's Face Automatically (Face Close-up Playback)

You can enjoy playing back images with the subject's faces zoomed up simply by pressing the  button (Face close-up playback) if Face Detection operated when the images were taken.

- 1** Enter the  mode and use the four-way controller ( ) to choose the image you want to magnify.



- 2** Confirm that the  icon is displayed in the image and press the  button.

The image is magnified around the face first detected when the image was taken.

If multiple faces were detected when the image was taken, the subject's faces are zoomed up on each time the  button is pressed in order of the detection during shooting.









- 3** Press the **OK** button.

The image returns to single-image display.



Movies cannot be played back in Face close-up.



- The magnification ratio for Face close-up playback may differ depending on the conditions such as the size of the face detected when shooting.
- Press  on the Zoom// button during Face close-up playback to switch to the zoom playback; the image is displayed at an equal or slightly larger magnification ratio. Press  on the Zoom// button to switch to the zoom playback; the image is displayed at an equal or slightly smaller magnification ratio.

Deleting Images

Delete images with mistakes or that are unnecessary.

When images are inadvertently deleted

With the Optio E90, images that were taken with this camera can be recovered (p.115).

Deleted images can be recovered if the camera has not been turned off or the SD Memory Card has not been removed after deletion. However, deleted images cannot be recovered after operations to write data such as taking pictures, recording movies, protecting images, saving DPOF settings, resizing images, cropping images or formatting have been performed.





Deleting a Single Image

You can delete a single image.

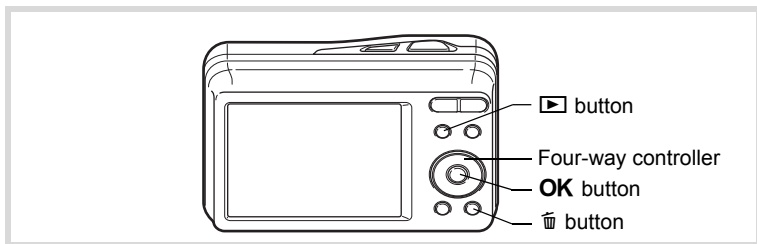

Protected images cannot be deleted (p.116).



- 1 Enter the  mode and use the four-way controller ( ) to choose the image you want to delete.**
- 2 Press the  button.**
A confirmation screen appears.

- 3** Use the four-way controller (▲▼) to select [Delete].



- 4** Press the OK button.

The image is deleted.

Recovering Deleted Images p.115

4 Deleting Selected Images

You can delete several images selected from the four-image or nine-image display at once.



Protected images cannot be deleted.

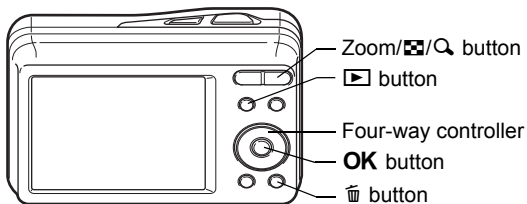

- 1** In ▶ mode, press [grid icon] on the Zoom/[grid icon]/Q button.



Four thumbnail images appear. Press [grid icon] again to display nine thumbnail images.

- 2 Press the  button.**
 appears on the images.



- 3 Use the four-way controller (▲▼◀▶) to choose the images that you want to delete and press the OK button.**

appears on the selected images.

If you select an image and press  on the Zoom// button, the selected image appears in single-image display as long as the button is pressed, enabling you to check whether you really want to delete it or not. (The display returns to the four-image or nine-image display when you release the button.) However, protected images cannot be displayed in single-image display.



- 4 Press the  button.**
 A confirmation dialog appears.

- 5 Use the four-way controller (▲▼) to select [Select & Delete].**



- 6 Press the OK button.**
 The selected images are deleted.

Deleting All Images

You can delete all the images at once.



Protected images cannot be deleted (p.116).

1 Press the MENU button in mode.

[Setting] menu appears.

When you press the MENU button in mode, press the four-way controller () once.

2 Use the four-way controller () to select [Delete all].

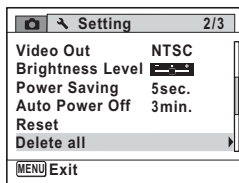

3 Press the four-way controller () .

The [Delete all] screen appears.

4 Use the four-way controller () to select [Delete all].

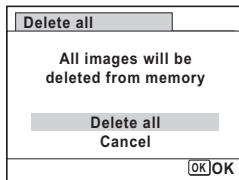

5 Press the OK button.

All the images are deleted.

Recovering Deleted Images

You can recover images that were taken with this camera and then deleted.



After deleting an image, once operations to write data such as taking pictures, recording movies, protecting images, saving DPOF settings, resizing images, cropping images or formatting have been performed, or the SD Memory Card has been removed, or the camera has been turned off, the message [No image to be processed] appears in Step 3 and the deleted images cannot be recovered.

1 After deleting a file, press the four-way controller (▼).
The Playback Mode Palette appears.

2 Use the four-way controller (▲▼◀▶) to select  (Image Recovery).



3 Press the OK button.

4 Use the four-way controller (▲▼) to select [Recover].



5 Press the OK button.

Deletion of the images is cancelled and the files are recovered.



Recovered images have the same file name as before they were deleted.

Protecting Images from Deletion (Protect)

You can protect stored images from being accidentally deleted.

1 Press the four-way controller (▼) in  mode.

The Playback Mode Palette appears.

2 Use the four-way controller (▲▼◀▶) to select  (Protect).

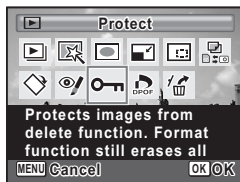

3 Press the OK button.

The screen for selecting [Single Image] or [All Images] appears.

4 Use the four-way controller (▲▼) to select [Single Image].



5 Press the OK button.

The message [Protects this image] appears. To protect another image, use the four-way controller (◀▶) to select another image.

6 Use the four-way controller (▲▼) to select [Protect].



7 Press the OK button.

The selected image is protected.



- To cancel the Protect setting, select [Unprotect] in Step 6.
- appears below the file number on protected images during playback.
- The maximum number of images you can protect in succession with [Single Image] cannot exceed 99.

To Protect All Images

1 Press the four-way controller (▼) in mode.

The Playback Mode Palette appears.

2 Use the four-way controller (▲▼◀▶) to select (Protect).

3 Press the OK button.

The screen for selecting [Single Image] or [All Images] appears.

4 Use the four-way controller (▲▼) to select [All Images].



5 Press the OK button.

6 Use the four-way controller (▲▼) to select [Protect].

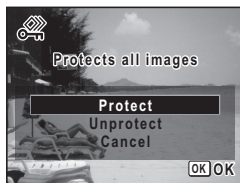

7

Press the OK button.

All the images are protected.



Protected images will be deleted when the SD Memory Card is formatted (p. 140).



To cancel the Protect setting on all your images, select [Unprotect] in Step 6.

4

Connecting the Camera to AV Equipment

By using the optional AV cable (I-AVC7), you can capture and play back images on equipment with a video IN jack, such as a TV. Make sure the camera and TV are turned off before connecting the camera to the TV.

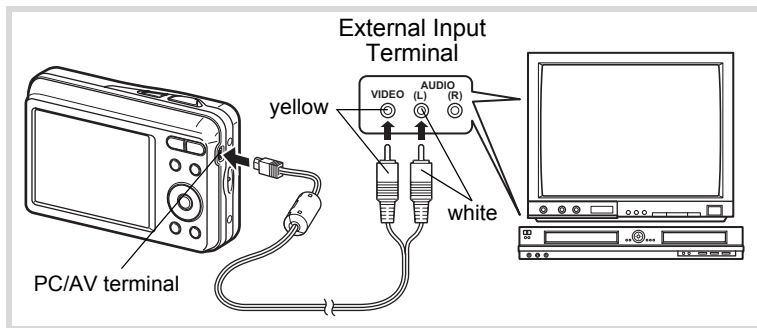

- 1 Connect the AV cable to the PC/AV terminal.**
Connect the terminal of the AV cable with pointing toward the ◀ on the PC/AV terminal of the camera.
- 2 Connect the other ends of the AV cable (yellow: video, white: audio) to the video input terminal and audio input terminal of the AV device.**
When using stereo sound equipment, insert the sound terminal into the L (white) terminal.
- 3 Turn the AV device on.**
When the device that the camera is connected to and the device that plays back images are different, turn both devices on.
When viewing images on AV equipment with multiple video input terminals (such as a TV), refer to the operation manual of the device and select the video input terminal to which the camera is connected.



- It is recommended to use the optional AC adapter kit K-AC62 if you intend to use the camera for a long time.
- Depending on the country or region, images and movie files may fail to be played back if the video output format is set different from the one in use there. If this happens, change the video output format setting (p.149).
- The camera display turns off while the camera is connected to AV equipment.
- Volume cannot be adjusted with the Zoom button while the camera is connected to AV equipment.

5 Editing and Printing Images

Editing Images	122
Setting the Printing Service (DPOF)	135

About printing

The following options are available for printing images taken with this camera.

- 1 Use a printing service.**
- 2 Use your printer with an SD Memory Card slot to print directly from the SD Memory Card.**
- 3 Use your computer's software to print images.**

Changing the Image Size (Resize)

By changing the size of a selected image, you can make the file size smaller than the original. You can use this function to continue taking pictures when the SD Memory Card or the built-in memory is full, by making the images smaller and overwriting the original images to make more space available.



- Images taken with $\overline{2.1M}$, images taken with $\overline{16}$ (16-frame shooting) mode, panoramic images and movies cannot be resized.
- You cannot select a larger resolution or higher quality than that of the original image.

5

1 Enter the  mode and use the four-way controller ($\blacktriangleleft \blacktriangleright$) to choose the image you want to resize.

2 Press the four-way controller (\blacktriangledown).

The Playback Mode Palette appears.

3 Use the four-way controller ($\blacktriangle \blacktriangledown \blacktriangleleft \blacktriangleright$) to select  (Resize).



4 Press the OK button.

The screen for choosing the size appears.

5 Select [Recorded Pixels].

Use the four-way controller (◀▶) to choose the size.

**6 Press the OK button.**

A confirmation dialog for overwriting the image appears. When an image is protected, the image will be saved as a new image without the following confirmation dialog displayed on the screen.

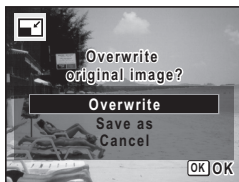
7 Use the four-way controller (▲▼) to select [Overwrite] or [Save as].**8 Press the OK button.**

The resized image is saved.

Cropping Images

You can delete the unwanted part of a picture and save the cropped image as a separate image.



Images taken with 2.1m, panoramic images, images taken with 16 (16-frame shooting) mode and movies cannot be cropped.

1 Enter the  mode and use the four-way controller (◀▶) to choose the image you want to crop.**2 Press the four-way controller (▼).**

The Playback Mode Palette appears.

- 3 Use the four-way controller (▲▼◀▶) to select  (Cropping).**



- 4 Press the OK button.**

The cropping screen appears.

The maximum range for cropping is shown with a green frame on the screen. Cropping cannot be performed inside of this area.

- 5 Choose the cropping conditions.**

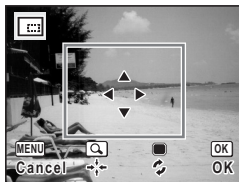

The following operations move the green frame and set the area for cropping on the screen.

- | | |
|---|--|
| Zoom/  /Q button | Changes the size of the cropped section |
| Four-way controller (▲▼◀▶) | Moves the cropping position up, down, left and right |
| Green button | Rotates the cropping frame |

- 6 Press the OK button.**

The cropped image is saved with a new file name.

The number of recorded pixels is selected automatically according to the size of the cropped section.

Using the Digital Filters

This mode lets you change the color tones and perform special processing on a selected image.

B&W Filter	Processes the image using the B&W filter.
Sepia Filter	Processes the image using the sepia filter.
Color Filter	Processes the image using the selected color filter. You can choose from six filters: red, pink, purple, blue, green, and yellow.
Fish-eye Filter	Creates an image that looks as though it was shot with a fish-eye lens.
Starburst Filter	Processes the image of night scenes or lights reflected on water with a special sparkling look achieved by adding effects to the image's highlights. You can choose from three filters: Cross, Heart and Star.
Brightness Filter	Adjusts the brightness of the image.

1 Enter the  mode and use the four-way controller (◀▶) to choose the image you want to edit.

2 Press the four-way controller (▼).
The Playback Mode Palette appears.

3 Use the four-way controller (▲▼◀▶) to select  (Digital Filter).



4 Press the OK button.

The digital filter selection screen appears.

- 1 B&W Filter
- 2 Sepia Filter
- 3 Color Filter
- 4 Fish-eye Filter
- 5 Starburst Filter
- 6 Brightness Filter



To Select a B&W Filter or Sepia Filter

- 5 Use the four-way controller (▲▼) to choose a digital filter.**

The preview image of the results of the filter effect appears.

- 6 Press the OK button.**

A confirmation dialog for overwriting the image appears. When an image is protected, the image will be saved as a new image without the following confirmation dialog displayed on the screen.

- 7 Use the four-way controller (▲▼) to select [Overwrite] or [Save as].**

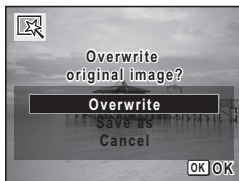

- 8 Press the OK button.**

Images processed with the filter are recorded with the same number of recorded pixels and quality level as the original image.

To Select a Color Filter

- 5 Use the four-way controller (▲▼) to choose a digital filter.**

- 6 Use the four-way controller (◀▶) to adjust the effect.**

The color filter changes in the following sequence each time you press the four-way controller (▶): Red, Pink, Purple, Blue, Green, Yellow.



7 Press the OK button.

A confirmation dialog for overwriting the image appears. When an image is protected, the image will be saved as a new image without the following confirmation dialog displayed on the screen.

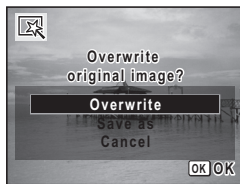
8 Use the four-way controller (▲▼) to select [Overwrite] or [Save as].**9 Press the OK button.**

Images processed with the filter are recorded with the same number of recorded pixels and quality level as the original image.

To Select a Fish-eye Filter, Starburst Filter or Brightness Filter**5 Use the four-way controller (▲▼) to select the digital filter you want to use.****6 Use the four-way controller (◀▶) to adjust the effect.**

	Four-way controller (▲▼)	Default Setting	Four-way controller (◀▶)
Fish-eye Filter	Weak	Medium	Strong
Starburst Filter	Cross (default setting)	Heart	Star
Brightness Filter	Dark	Standard	Bright

7 Press the OK button.

A confirmation dialog for overwriting the image appears.

When an image is protected, the image will be saved as a new image without the following confirmation dialog displayed on the screen.

8 Use the four-way controller (▲▼) to select [Overwrite] or [Save as].**9 Press the OK button.**

Images processed with the filter are recorded with the same number of recorded pixels and quality level as the original image.



Panoramic images, movies or images taken with another camera cannot be edited using Digital Filter function. An error message appears if you choose this function from the Playback Mode Palette and press the **OK** button.

Red-eye Compensation

You can correct images where the flash has caused the subject to appear with red eyes.

1 Enter the [] mode and use the four-way controller (◀▶) to choose the image you want to correct.**2 Press the four-way controller (▼).**

The Playback Mode Palette appears.

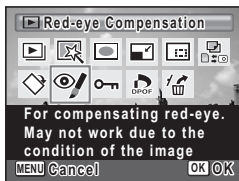
3 Use the four-way controller (▲▼◀▶) to select [Red-eye Compensation].

4 Press the OK button.

A confirmation dialog for overwriting the image appears.

When an image is protected, the image will be saved as a new image without the following confirmation dialog displayed on the screen.

5 Use the four-way controller (▲▼) to select [Overwrite] or [Save as].**6 Press the OK button.**

The edited image is saved with the same number of recorded pixels and quality level as the original.



- The red-eye compensation function cannot be used on panoramic images, images taken with (16-frame shooting) mode, movies or on images where red eyes cannot be detected on the camera. An error message appears in Step 4.
- The red-eye compensation function can only be used with still pictures taken with this camera.

Adding a Frame (Frame Composite)

This function lets you add a decorative frame to still pictures. There are 20 frames already stored in the camera.

1 Enter the mode and use the four-way controller (◀▶) to choose the image to which you want to add a frame.**2 Press the four-way controller (▼).**

The Playback Mode Palette appears.

- 3 Use the four-way controller (▲▼◀▶) to select  (Frame Composite).**

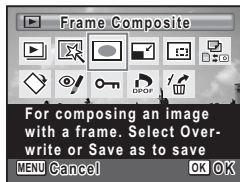



- 4 Press the OK button.**

A 9-frame display of the frame selection screen appears.

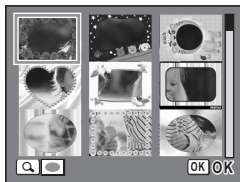
- 5 Use the four-way controller (▲▼◀▶) to choose a frame.**





- 6 Press  on the Zoom//Q button.**

The selected frame appears in single-image display.

You can choose another frame using either of the following operations.

Four-way controller (◀▶) Press to choose a different frame.

Zoom//Q button () Press to return to the 9-frame display of the frame selection screen, and then perform Step 5 to choose a different frame.

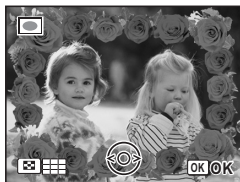

- 7 Press the OK button.**

The frame position and size adjustment screen appears.

Use the four-way controller (▲▼◀▶) to adjust the position of the image, and use the Zoom//Q button to make the image larger or smaller.

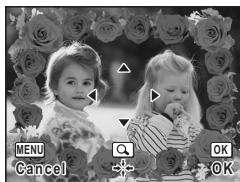

8 Press the OK button.

A confirmation dialog for overwriting the image appears.

When an image is protected, the image will be saved as a new image without the following confirmation dialog displayed on the screen.

9 Use the four-way controller (▲▼) to select [Overwrite] or [Save as].



10 Press the OK button.

The edited image is saved with the recorded pixels of **3M**.



The Frame Composite function cannot be used on images taken with **2.1M**, panoramic images, images taken with **16** (16-frame shooting) mode, movies or images of size smaller than **3M**. An error message appears in Step 4.

Optional Frames

The optional frames are stored in the built-in memory in the Optio E90. These optional frames are deleted if the built-in memory is formatted or if the built-in memory files are deleted from a computer. To reload the optional frames into the built-in memory, copy the files from the CD-ROM (S-SW104) supplied with the camera.

To Copy Frames

- 1 Remove the SD Memory Card from the camera.**
If you leave the SD Memory Card in the camera, the frames will be copied onto the card, not into the camera's built-in memory.
 - 2 Connect the camera to the computer using the provided USB cable (I-USB98).**
See "Connecting with Computers" in chapter 7 for instructions on connecting the camera to a computer.
 - 3 When the device detection window opens, click [Cancel].**
 - 4 Insert the CD-ROM (S-SW104) into the CD-ROM drive.**
 - 5 When the installer window opens, click [EXIT].**
 - 6 If there is not already a "FRAME" folder in the root directory of the camera (removable disk), create the folder.**
 - 7 Copy the desired files from the FRAME folder in the root directory of the CD-ROM to the FRAME folder on the camera (removable disk).**
For information on working with files on your computer, refer to the instruction manual supplied with the computer.
 - 8 Disconnect the USB cable from the computer and camera.**
See "Connecting with Computers" in chapter 7 for instructions on disconnecting the cable.
- Frames can be stored both in the built-in memory and on SD Memory Cards, but using large numbers of frames may slow down processing times.

To Use a New Frame

Frames downloaded from a PENTAX website or other source can be used for adding a frame to pictures.



- Extract the downloaded frame and copy it to the FRAME folder in the built-in memory or the SD Memory Card.
- The FRAME folder is created when the SD Memory Card is formatted with this camera.
- For more information on downloading, refer to the PENTAX website.

Copying Images

You can copy images from the built-in memory to the SD Memory Card and vice versa. This function can only be selected when an SD Memory Card has been inserted in the camera.



Make sure that the camera is turned off before inserting or removing the SD Memory Card.

1 Press the four-way controller (▼) in mode.

The Playback Mode Palette appears.

2 Use the four-way controller (▲▼◀▶) to select (Image Copy).

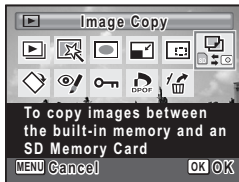

3 Press the OK button.

The copying method selection screen appears.

To Copy Files from the Built-in Memory to the SD Memory Card

All the images in the built-in memory are copied to the SD Memory Card at once. Before copying the images, make sure that there is enough space on the SD Memory Card.

- 4 Use the four-way controller (▲▼) to select [ → ].

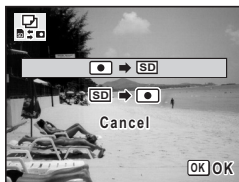



- 5 Press the OK button.
All the images are copied.

5

To Copy Files from the SD Memory Card to the Built-in Memory

Selected images from the SD Memory Card are copied to the built-in memory one at a time.

- 4 Use the four-way controller (▲▼) to select [ → ].
- 5 Press the OK button.
- 6 Use the four-way controller (◀▶) to select the image you want to copy.



- 7 Press the OK button.
The selected image is copied.



When a file is copied from the SD Memory Card to the built-in memory, it is assigned a new file name.

Setting the Printing Service (DPOF)

DPOF (Digital Print Order Format) is the format for storing print order data on still pictures captured with a digital camera. Once the print order data has been stored, the pictures can be printed according to the DPOF settings using a DPOF-compatible printer or photo processing lab. You cannot store print order data for movies.



If the picture already has the date and/or time imprinted on it (p.92), do not set [Date] (On) in DPOF settings. If you select (On), the imprinted date and/or time may overlap.

Printing Single Images

Set the following items for each image.

Copies	Choose the number of copies up to 99.
Date	Specify whether you want the date inserted on the print or not.

1 In mode, press the four-way controller (▼).
The Playback Mode Palette appears.

2 Use the four-way controller (▲▼◀▶) to select (DPOF).

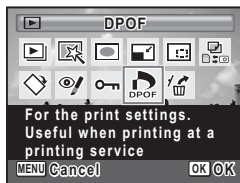

3 Press the OK button.
The screen for selecting [Single Image] or [All Images] appears.

- 4** Use the four-way controller (▲▼) to select [Single Image].



- 5** Press the **OK** button.

The message [Applies DPOF settings to this image] appears.

To apply DPOF settings for another image, use the four-way controller (◀▶) to select another image.

If DPOF settings have already been applied for an image, the previous number of copies and date setting (☑ or ☐) will be displayed.

- 6** Use the four-way controller (▲▼) to choose the number of copies.



- 7** Use the **Green** button to choose whether to insert the date or not.

(On) The date will be imprinted.

(Off) The date will not be imprinted.

To continue setting DPOF print order data, use the four-way controller (◀▶) to choose another image and repeat Steps 6 and 7.



- 8** Press the **OK** button.

The setting is saved and the screen returns to the DPOF menu.





Depending on the printer or printing equipment at the photo processing lab, the date may not be imprinted on the pictures even if ☑ (On) was selected in the DPOF settings.



To cancel DPOF settings, set the number of copies to [00] in Step 6 and press the **OK** button.

Printing All Images

When you choose the number of copies and whether or not to insert the date, the settings are applied to all the images stored in the camera.

- 1 Display the screen for DPOF settings in  mode.**
Refer to Steps 1 to 3 on p.135.
- 2 Use the four-way controller ( ) to select [All Images].**
- 3 Press the OK button.**
The message [Applies DPOF settings to all images] appears.
- 4 Choose the number of copies and whether to insert the date or not.**
Refer to Steps 6 and 7 in “Printing Single Images” (p.136) for details of how to make the settings.
- 5 Press the OK button.**
The settings for all the images are saved and the camera returns to the DPOF setting screen.



The number of copies specified in the DPOF settings applies to all the images. Before printing, check that the number is correct.



Settings for single images are canceled when settings are made with [All Images].

Memo

6 Settings

Camera Settings	140
-----------------------	-----

Formatting an SD Memory Card

Formatting will delete all the data on the SD Memory Card.



Be sure to use this camera to format (initialize) an SD Memory Card that is unused or has been used on other cameras or digital devices.



- Do not remove the SD Memory Card during formatting as this may damage the card and render it unusable.
- Formatting will delete all the data on the card, including protected images and images recorded with a computer or camera other than this camera.
- SD Memory Cards formatted on a computer or device other than the camera cannot be used. Be sure to format the card with the camera.
- The built-in memory cannot be formatted except when an error occurs.

1 Press the **MENU** button in mode.

[ Setting] menu appears.

When you press the **MENU** button in  mode, press the four-way controller () once.

2 Use the four-way controller () to select [**Format**].

3 Press the four-way controller () .

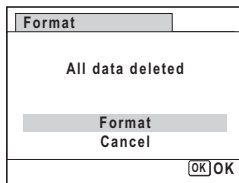

The [**Format**] screen appears.

4 Use the four-way controller () to select [**Format**].



5 Press the OK button.

Format starts.



When formatting is completed, the camera returns to  mode or  mode.

Changing the Sound Settings

You can adjust the volume of operation sounds and change the type of sound.

1 Press the MENU button in mode.

[ Setting] menu appears.

When you press the **MENU** button in  mode, press the four-way controller () once.

2 Use the four-way controller () to select [Sound].

3 Press the four-way controller () .

The [Sound] screen appears.

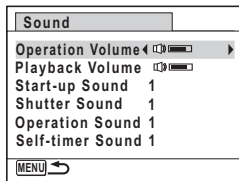

To Change the Operation Volume/Playback Volume

4 Use the four-way controller () to select [Operation Volume].

5 Use the four-way controller () to adjust the volume.

Set the volume to 0 to mute the start-up sound, shutter sound, operation sound, and self-timer sound.



6 Change [Playback Volume] in the same way as in Steps 4 and 5.

To Change the Sound Type

- 4** Use the four-way controller (▲▼) to select [Start-up Sound].
- 5** Press the four-way controller (▶).
A pull-down menu appears.
- 6** Use the four-way controller (▲▼) to select the sound type.
Choose from [1], [2], [3] or [Off].
- 7** Press the OK button.
- 8** Set [Shutter Sound], [Operation Sound] and [Self-timer Sound] in the same way as in Steps 4 to 7.
- 9** Press the MENU button.
The screen returns to the [↖ Setting] menu.

6 Changing the Date and Time

You can change the initial date and time settings. You can also set the style in which the date appears on the camera.

- 1** Press the MENU button in  mode.
[↖ Setting] menu appears.
When you press the MENU button in  mode, press the four-way controller (▶) once.
- 2** Use the four-way controller (▲▼) to select [Date Adjustment].
- 3** Press the four-way controller (▶).
The [Date Adjustment] screen appears.

4 Press the four-way controller (▶).

The frame moves to [mm/dd/yy].
Depending on the initial setting or previous setting, [dd/mm/yy] or [yy/mm/dd] may be displayed.

Date Adjustment	
Date Format	▶mm/dd/yy 24h
Date	01/01/2010
Time	00:00
Settings complete	
[MENU]Cancel	

5 Use the four-way controller (▲▼) to choose the date and time display style.

Choose from [mm/dd/yy], [dd/mm/yy] or [yy/mm/dd].

Date Adjustment	
Date Format	◀mm/dd/yy 24h
Date	01/01/2010
Time	00:00
Settings complete	
[MENU]Cancel	

6 Press the four-way controller (▶).

The frame moves to [24h].

7 Use the four-way controller (▲▼) to select [24h] (24-hour display) or [12h] (12-hour display).

Date Adjustment	
Date Format	◀mm/dd/yy 24h
Date	01/01/2010
Time	00:00
Settings complete	
[MENU]Cancel	

8 Press the four-way controller (▶).

The frame returns to [Date Format].

9 Press the four-way controller (▼).

The frame moves to [Date].

10 Press the four-way controller (▶).

The frame moves to one of the following items depending on the date format set in Step 5.

For [mm/dd/yy] month (Example: [01])

For [dd/mm/yy] day (Example: [01])

For [yy/mm/dd] year (Example: [2010])

The following operations and screens use [mm/dd/yy] as an example. The operations are the same even if another date format has been selected.

Date Adjustment	
Date Format	mm/dd/yy 24h
Date	▶01/01/2010
Time	00:00
Settings complete	
[MENU]Cancel	

11 Use the four-way controller (▲▼) to change the month.

Date Adjustment	
Date Format	mm/dd/yy 24h
Date	◀01/01/2010
Time	00:00
Settings complete	
[MENU]Cancel	

12 Press the four-way controller (▶).

The frame moves to the day field. Use the four-way controller (▲▼) to change the day. After changing the day, change the year in the same manner.

13 Change the time in the same way as in Steps 8 to 11.

If you selected [12h] in Step 7, the setting switches between am and pm corresponding to the time.



14 Press the four-way controller (▼) to select [Settings complete].**15 Press the OK button.**

The date and time settings are saved.



When you press the **OK** button in Step 15, the camera clock is reset to 00 seconds. To set the exact time, press the **OK** button when the time signal (on the TV, radio, etc.) reaches 00 seconds.



Setting the World Time

The date and time selected in “Setting the Date and Time” (p.41) and “Changing the Date and Time” (p.142) serve as the  (Hometown) date and time. By using the world time function, you can display the time in a city other than the Hometown ( Destination). This is useful when taking pictures in a different time zone.

To Set the Destination

1 Press the MENU button in mode.

[ Setting] menu appears.

When you press the MENU button in  mode, press the four-way controller () once.

2 Use the four-way controller () to select [World Time].

3 Press the four-way controller ().

The [World Time] screen appears.

4 Use the four-way controller () to select (Destination).

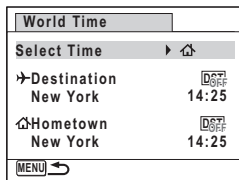

5 Press the four-way controller ().

The [Destination] screen appears. The city that is currently selected blinks on the map.

6 Use the four-way controller () to change the Destination city.

The current time, location and time difference of the selected city appear.

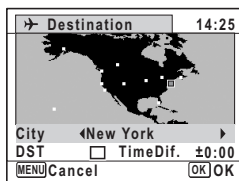

- 7** Use the four-way controller (▲▼) to select [DST].
- 8** Use the four-way controller (◀▶) to select (On) or (Off).
Select (On) if the Destination city uses daylight saving time.
- 9** Press the OK button.
The [World Time] setting is saved.
- 10** Press the MENU button twice.
The camera returns to capture status with the current setting.



Select (Hometown) in Step 4 of p.145 to set the city and DST setting for the Hometown city.

To Display the Time of the Destination on the Display (Select Time)

- 1** Press the MENU button in mode.
[Setting] menu appears.
When you press the MENU button in mode, press the four-way controller (▶) once.
- 2** Use the four-way controller (▲▼) to select [World Time].
- 3** Press the four-way controller (▶).
The [World Time] screen appears.
- 4** Use the four-way controller (▲▼) to select [Select Time].
- 5** Press the four-way controller (▶).
A pull-down menu appears.

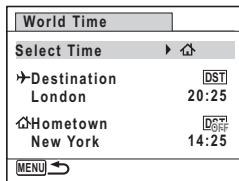

6 Use the four-way controller (▲▼) to select → (Destination) or ↻ (Hometown).

- Displays the time of the Destination city
- ↻ Displays the time of the Hometown city

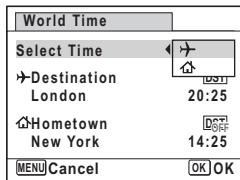

7 Press the OK button.

The setting is saved.

8 Press the MENU button twice.

The camera returns to 📷 mode or ▶ mode.

When → (Destination) is selected in Step 6, the → icon appears on the display to indicate that the destination date and time are displayed in 📷 mode.

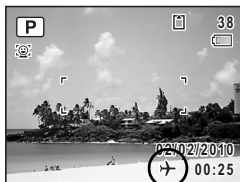

Changing the Display Language

You can change the language in which the menus, error messages, etc. are displayed.

The camera supports the following 20 languages: English, French, German, Spanish, Portuguese, Italian, Dutch, Japanese, Danish, Swedish, Finnish, Polish, Czech, Hungarian, Turkish, Greek, Russian, Thai, Korean and Chinese (traditional and simplified).

1 Press the MENU button in ▶ mode.

[↻ Setting] menu appears.

When you press the **MENU** button in 📷 mode, press the four-way controller (▶) once.

2 Use the four-way controller (▲▼) to select [Language/言語].

3 Press the four-way controller (▶).

The [Language/言語] screen appears.

4 Use the four-way controller (▲▼◀▶) to select the language.

Language/言語		
English	日本語	Türkçe
Français	Dansk	Ελληνικά
Deutsch	Svenska	Русский
Español	Suomi	ไทย
Português	Polski	한국어
Italiano	Čeština	中文繁體
Nederlands	Magyar	中文简体
MENU/Cancel		OK/OK

5 Press the OK button.

The menus and messages are displayed in the selected language.

Changing the Naming System of the Folder

You can change the naming system of the folder for storing images. When the name is changed to the date, pictures are saved in separate folders by the date they were taken.

Date	xxx_mmdd (3-digit folder number_month day) * xxx_ddmm (3-digit folder number_day month) when the date format is set to [dd/mm/yy]
Standard	xxxPENTX (where xxx is the 3-digit folder number)

Taken with the folder name setting [Standard]. (e.g. September 25)

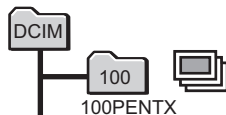



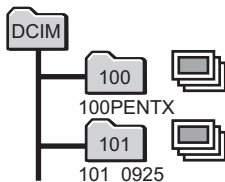



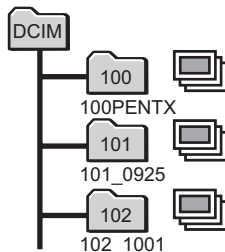

Taken with the folder name setting [Date]. (e.g. September 25)



Next time, taken with the folder name setting [Date] again. (e.g. October 1)











- Up to 900 folders can be created.
- Up to 9999 images can be saved in a folder.

- 1 Press the MENU button in  mode.**
[ Setting] menu appears.
When you press the **MENU** button in  mode, press the four-way controller () once.
- 2 Use the four-way controller ( ) to select [Folder Name].**
- 3 Press the four-way controller () .**
A pull-down menu appears.
- 4 Use the four-way controller ( ) to select [Standard] or [Date].**
- 5 Press the OK button.**
The setting is saved.

Changing the Video Output Format

When you connect the camera to AV equipment, choose the appropriate video output format (NTSC or PAL) for taking and playing back images.

- 1 Press the MENU button in  mode.**
[ Setting] menu appears.
When you press the **MENU** button in  mode, press the four-way controller () once.
- 2 Use the four-way controller ( ) to select [Video Out].**
- 3 Press the four-way controller () .**
A pull-down menu appears.
- 4 Use the four-way controller ( ) to select video output format.**
Choose a video output format to match the output format of the AV equipment.

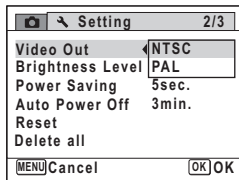

5 Press the OK button.

The setting is saved.



Depending on the country or region, images may fail to be played back if the video output format is set different from the one in use there. If this happens, change the video output format setting.

Connecting the Camera to AV Equipment p.119
Video output format of each city p.182

Adjusting the Brightness of the Display

You can adjust the brightness of the display.

1 Press the MENU button in mode.

[Setting] menu appears.

When you press the **MENU** button in mode, press the four-way controller () once.

2 Use the four-way controller () to select [Brightness Level].

3 Use the four-way controller () to adjust the brightness.

Dark
 Normal
 Bright

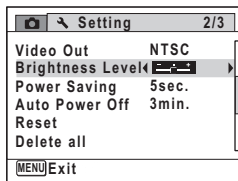

4 Press the MENU button.



The camera returns to mode or mode.
The display appears with the set brightness.

Using the Power Saving Function

You can save battery power by setting the display to dim automatically when no operation is performed for a fixed time. After the power saving function has been activated, the display returns to the ordinary brightness by pressing any of the buttons.

1 Press the **MENU** button in mode.

[ Setting] menu appears.

When you press the **MENU** button in  mode, press the four-way controller () once.

2 Use the four-way controller () to select [Power Saving].

3 Press the four-way controller ().

A pull-down menu appears.

4 Use the four-way controller () to select the time until the camera enters power saving mode.

Choose from [2min.], [1min.], [30sec.], [15sec.], [5sec.] or [Off.].

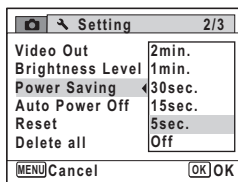

5 Press the **OK** button.

The setting is saved.





- Power Saving does not function in the following situations:
 - in the playback mode
 - while recording a movie
 - while the camera is connected to a computer
 - while a menu is being displayed
- When no operation is performed after the camera is turned on, Power Saving is activated only after 15 seconds elapse even if [5sec.] is set.

Setting Auto Power Off

You can set the camera to turn off automatically when no operation is performed for a fixed time.

1 Press the **MENU** button in mode.

[ Setting] menu appears.

When you press the **MENU** button in  mode, press the four-way controller () once.

2 Use the four-way controller () to select [**Auto Power Off**].

3 Press the four-way controller ().

A pull-down menu appears.

4 Use the four-way controller () to select the time until the camera turns off automatically.

Choose from [5min.], [3min.] or [Off].

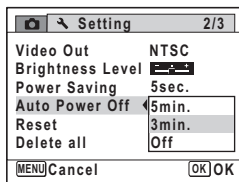

5 Press the **OK** button.

The setting is saved.



Auto Power Off does not function in the following situations:



- while recording a movie
- during a slideshow or movie playback
- while the camera is connected to a computer

Resetting to Default Settings (Reset)

You can reset the camera settings to their defaults. Refer to “Default Settings” (p.178) for the reset settings.

1 Press the **MENU** button in mode.

[ Setting] menu appears.

When you press the **MENU** button in  mode, press the four-way controller () once.

2 Use the four-way controller () to select [Reset].

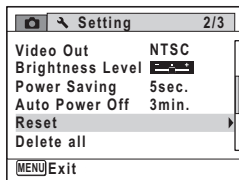

3 Press the four-way controller () .

The [Reset] screen appears.

4 Use the four-way controller () to select [Reset].

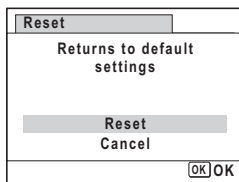

5 Press the **OK** button.

The settings return to the defaults.



The following settings are not affected by resetting:

- Date Adjustment
- World Time
- Language/言語
- Video Out

Memo

7 Viewing Images on a Computer

Setting Up Your Computer	156
Connecting to Your Computer	163

Setting Up Your Computer

By installing the software included on the provided CD-ROM on your computer and connecting the camera to your computer with the USB cable, you can transfer images and movies captured with your camera to the computer and then display and manage them. This section explains how to install the provided software and the other necessary preparations for enjoying the captured pictures and movies on your computer.

Provided Software

The following software is included in the provided CD-ROM (S-SW104).

Image viewing/managing/editing software “MedialImpression 2.0 for PENTAX”

Twelve languages: English, French, German, Spanish, Portuguese, Italian, Dutch, Swedish, Russian, Korean, Chinese (traditional and simplified), Japanese



It is recommended to use the optional AC adapter kit K-AC62 when the camera is connected to the computer (p.29). If the battery runs out of power while images are being transmitted to the computer, the image data may be lost or damaged.

7

Viewing Images on a Computer

System Requirements

The following system requirements must be met for you to fully enjoy the images and movies captured with the camera on your computer.

Windows

OS	Windows XP, Windows Vista or Windows 7 <ul style="list-style-type: none">The OS must be preinstalled and updated to the latest version.
CPU	Pentium IV 1.6 GHz or equivalent AMD Athlon (Intel Core 2 Duo 2.0 GHz or equivalent AMD Athlon X2 processor recommended)
Memory	512 MB minimum (1 GB or more recommended)
Hard Disk Space	300 MB minimum
Others	CD-ROM drive USB port as standard equipment 1024 × 768 pixels, 16-bit color monitor or greater

- * Operation is not guaranteed on all computers meeting the system requirements.
- * The system requirements describe the minimum environment for playing and editing movies.



Windows 95, Windows 98, Windows 98SE, Windows Me, Windows NT and Windows 2000 are not supported.

Macintosh

OS	Mac OS X (Ver.10.3, 10.4, 10.5, 10.6) <ul style="list-style-type: none">The OS must be preinstalled and updated to the latest version.
CPU	PowerPC G4 800 MHz processor or equivalent CPU (Power PC G5 or Intel Core Duo processor recommended)
Memory	512 MB minimum (1 GB or more recommended)
Hard Disk Space	300 MB minimum
Others	CD-ROM drive USB port as standard equipment 1024 × 768 pixels, 16-bit color monitor or greater

- * Operation is not guaranteed on all computers meeting the system requirements.
- * The system requirements describe the minimum environment for playing and editing movies.

Installing the Software

Install the image viewing/managing/editing software “MediaImpression 2.0 for PENTAX”.



- Make sure your computer meets the system requirements before installing the software.
- When multiple accounts have been set up in your computer, log on with an account that has administrative rights before installing the software.

Windows

- 1 Turn your Windows PC on.**
- 2 Insert the provided CD-ROM into the CD-ROM/DVD drive.**
If the installation screen appears, go to Step 5.
- 3 Click [Computer] in the Start menu.**
- 4 Double-click the CD-ROM/DVD drive (S-SW104) icon.**
The installation screen appears.
- 5 Click [MediaImpression 2.0 for PENTAX], choose a language in the “Choose Setup Language” screen and click [OK].**

The setup screen appears. Follow the on-screen guidance and install the software.



6 Select the file format to use and click [Next].

All files in the checked format will open with MediaImpression 2.0 for PENTAX. Remove the check to open the file using another application.

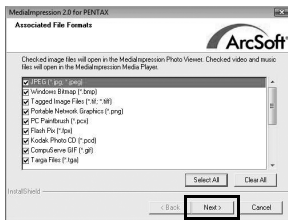

7 Click [Finish].

Installation is complete. Reboot your computer.

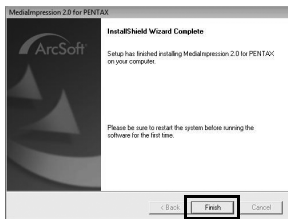

Macintosh

1 Turn your Macintosh on.

2 Insert the provided CD-ROM into the CD-ROM/DVD drive.

3 Double-click the CD-ROM (S-SW104) icon.

4 Double-click the [PENTAX Software Installer] icon.

The installation screen appears.

5 Click [MediaImpression 2.0 for PENTAX].

The setup screen appears. Follow the on-screen guidance and install the software.



- 6** Click [Close].
Installation is complete.

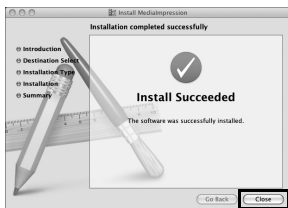

- 7** Click [Exit] on the installation screen.
The window is closed.

Product Registration on the Internet

In order to better serve you, we request that you complete the product registration.

If your computer is connected to the Internet, please click [Product Registration] on the installation screen. The world map screen shown on the right for Internet Product Registration is displayed. Click the displayed country or region and then follow the instructions to register your product.

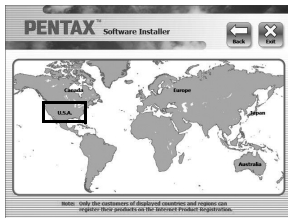

Only customers in countries and regions displayed on the software installation screen can register their products on the Internet Product Registration.

7

Viewing Images on a Computer

Setting the USB Connection Mode

Set the device to which the camera is connected with the USB cable.





Make sure to set the USB Connection mode before connecting your camera to the computer. You cannot perform the following setting if the camera is connected to your computer with the USB cable.

1 Turn your camera on.

2 Press the MENU button in  mode.



The [ Setting] menu appears.

When you press the **MENU** button in  mode, press the four-way controller () once.

3 Use the four-way controller ( ) to select [USB Connection].

4 Press the four-way controller ().

A pull-down menu appears.

5 Use the four-way controller ( ) to select [MSC].

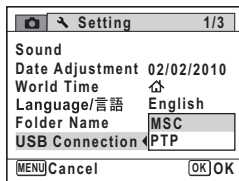

6 Press the OK button.

The setting is saved.

MSC (Mass Storage Class) and PTP (Picture Transfer Protocol)

MSC (Mass Storage Class)

A general-purpose driver program that handles devices connected to the computer via USB as a memory device. Also indicates a standard for controlling USB devices with this driver.

By simply connecting a device that supports USB Mass Storage Class, you can copy, read, and write files from a computer without installing a dedicated driver.

PTP (Picture Transfer Protocol)

A protocol that allows transfer of digital images and control of digital cameras via USB, standardized as ISO 15740.

You can transfer image data between devices that support PTP without installing a device driver.

Unless otherwise specified, select MSC when connecting the Optio E90 to your computer.

Connecting to Your Computer

Connecting the Camera and the Computer

Connect your camera to the computer using the provided USB cable (I-USB98).

- 1 Turn your computer on.**
- 2 Turn your camera off.**
- 3 Connect your camera to the computer using the USB cable.**

Connect the terminal of the USB cable with \leftarrow pointing toward the \blacktriangleleft on the PC/AV terminal of the camera.

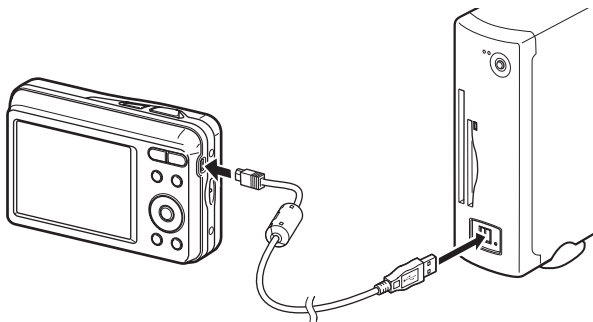

- 4 Turn your camera on.**

For Windows, the “AutoPlay” screen appears on the computer. If the “AutoPlay” screen does not appear, follow the steps in “When the [AutoPlay] screen does not appear” (p.164).

For Macintosh, the camera is recognized as [NO NAME] on the desktop.





- The power switch blinks while the camera is connected to a computer.
- For Macintosh, the volume label name appears instead of [NO NAME] if the SD Memory Card has a volume label. A new unformatted SD Memory Card may show the manufacturer name or model number.

When the [AutoPlay] screen does not appear

1 Double-click the [Medialmpression 2.0 for PENTAX] icon on the desktop.



Medialmpression 2.0 for PENTAX starts and the Start page appears.

2 Click [Import].

The import screen appears. For subsequent steps, go to Step 6 on p.165.

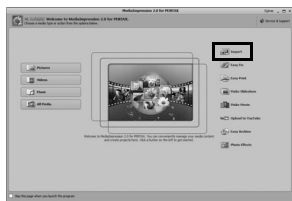

Transferring Images

Import the images captured with the camera into your computer.



- If there is no SD Memory Card in the camera, the images stored in the built-in memory will be transferred to your computer.
- If you are using a Macintosh, go to p.166.

5 Click [Import media files to local disk].

MediaImpression 2.0 for PENTAX starts and the import screen appears.



6 Select an image to import.

To select multiple images, choose the images while pressing the Ctrl key. To specify the destination location, click the folder icon.

If any of the "Import Options" are checked, marks will appear on the appropriate images that were imported.

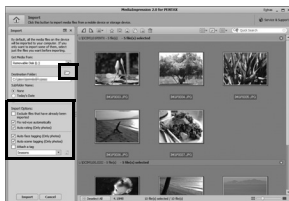

7 Click [Import].

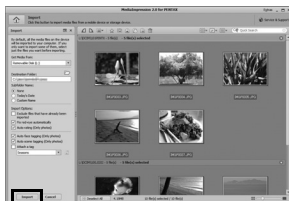

The images are imported to the computer and the Media Browser screen appears. When a message appears after import is complete, click [Done].



If the images from the camera are not displayed in the import screen, select [Removable Disk] in [Get Media from]. If the SD Memory Card has a volume label, the volume label name appears instead of [Removable Disk]. The manufacturer name or model number may appear for a new unformatted SD Memory Card.

7

Macintosh

5 Double-click the [MedialImpression 2.0 for PENTAX] icon in the [Applications] folder.



MedialImpression 2.0 for PENTAX

MedialImpression 2.0 for PENTAX starts and the Start page appears.

6 Click [Import].

The import screen appears. For subsequent steps, refer to Step 6 and 7 on p.165.

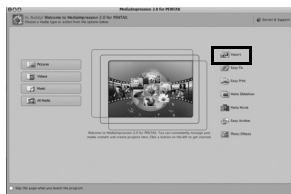

If the images from the camera are not displayed in the import screen, select [NO NAME] (or the volume label name) in [Get Media from].

Disconnecting the Camera from Your Computer

Windows

1 Double-click the [Safely Remove Hardware] icon in the task bar.

The “Safely Remove Hardware” screen appears.



2 Select [USB Mass Storage Device] and click [Stop].

The “Stop a Hardware device” screen appears.

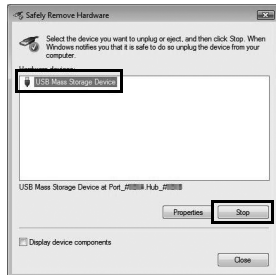

7

Viewing Images on a Computer

3 Select [USB Mass Storage Device] and click [OK].

A message appears indicating that the hardware can be safely removed.



4 Disconnect the USB cable from your Windows PC and the camera.

Macintosh

1 Drag [NO NAME] on the desktop to the trash.

If the SD Memory Card has a volume label, drag the icon of that name to the trash.

2 Disconnect the USB cable from your Macintosh and the camera.



- If the camera (removable disk) is being used by an application such as “Medialmpression 2.0 for PENTAX”, the camera cannot be disconnected until the application is closed.
- The camera will automatically switch to the playback mode when the USB cable is disconnected from your computer or the camera.

Starting “Medialmpression 2.0 for PENTAX”

“Medialmpression 2.0 for PENTAX” lets you view, edit, manage, search for, share, and print images.

1 Double-click the [Medialmpression 2.0 for PENTAX] icon on the desktop (for Windows) or in the [Applications] folder (for Macintosh).

Medialmpression 2.0 for PENTAX starts and the Start page appears.

2**Click [All Media].**

The Media Browser screen appears.

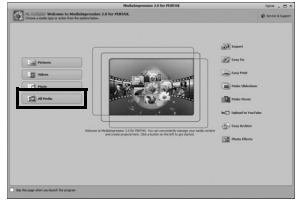

* The screen shown is for a Windows PC. Items shown will differ depending on the operating system and settings.

3**Select and click the folder containing the images you wish to view.**

The images are displayed.

**4****Select and double-click an image you wish to view.**

The selected image is displayed with Mediaspace Photo Viewer. You can enlarge/reduce the display size of the image or edit the image. You can also play back movies or sound files.

**7**

Details on How to Use “Medialmpression 2.0 for PENTAX”

You can find more information on how to use “Medialmpression 2.0 for PENTAX” by using the help pages.

- 1 Select [Help] in [Extras] at the top right of the screen (for Windows) or [Medialmpression Help] in [Help] on the menu bar (for Macintosh).**

The help screen appears in the web browser.

- 2 Click the desired topic.**

The explanation is displayed.



8 Appendix

Functions Available for Each	
Shooting Mode	172
Messages	174
Troubleshooting	176
Default Settings	178
List of World Time Cities	182
Optional Accessories	183
Main Specifications	184
WARRANTY POLICY	188
Index	194

Functions Available for Each Shooting Mode

✓: Can be set. ×: Cannot be set.

Function		Shooting Mode								
		AUTO PICT		P						
Ⓞ Button	Face Detection On	✓	✓	✓	✓	✓	✓	✓	✓	✓
	Smile Capture	✓	✓	✓	✓	✓	✓	✓	✓	✓
	Face Detection Off	×	✓	✓	✓	×	×	✓	✓	✓
Flash Mode	(Auto)	✓	✓	✓	×	✓	✓	×	✓	✓
	(Flash Off)	✓	✓	✓	✓	✓	✓	✓	✓	✓
	(Flash On)	✓	×	✓	✓	✓	✓	×	✓	✓
	(Flash On + Red-eye)	✓	×	✓	✓	✓	✓	×	✓	✓
Drive Mode	(Standard)	✓	✓	✓	✓	✓	✓	✓	✓	✓
	(Self-timer)	✓	✓	✓	✓	✓	✓	✓	✓	✓
	(2 sec. Self-timer)	✓	✓	✓	✓	✓	✓	✓	✓	✓
	(Continuous Shooting)	×	×	✓	×	✓	✓	×	✓	✓
	(16-frame shooting)	×	×	✓	×	✓	×	×	✓	✓
Focus Mode	AF (Standard)	✓	✓	✓	✓	✓	✓	✓	✓	✓
	(Macro)	✓	✓	✓	✓	✓	✓	✓	✓	✓
	PF (Pan Focus)	✓	✓	✓	✓	✓	✓	✓	✓	✓
	(Infinity)	✓	×	✓	✓	✓	✓	✓	✓	✓
Recorded Pixels		✓	×*1	✓	✓	✓	✓	×*2	✓	✓
Focusing Area		×*4	×*4	✓	✓	✓	✓	✓	×*5	✓
Sensitivity		✓	×*6	✓	✓	✓	✓	✓	×*6	✓
EV Compensation		×*7	×*7	✓	✓	✓	✓	✓	✓	✓
Zoom		✓	✓*8	✓	✓	✓	✓	✓	✓*8	✓
Date Imprint		✓	×	✓	✓	✓	✓	✓	×	✓

*1 Fixed at **10M**

*2 Fixed at **3M**

*3 Fixed at **2M**

*4 Fixed at [] (Multiple)

*5 (Automatic Tracking AF) is not available

*6 Fixed at Auto

((A))			Shooting Mode		Page
				Function	
✓	✓	✓	Face Detection On	:@: Button	p.61
✓	✓	×	Smile Capture		
✓	✓	✓	Face Detection Off		
✓	✓	✓	(Auto)	Flash Mode	p.84
✓	✓	✓	(Flash Off)		
✓	✓	✓	(Flash On)		
✓	✓	✓	(Flash On + Red-eye)		
✓	✓	✓	(Standard)	Drive Mode	—
✓	✓	✓	(Self-timer)		p.78
✓	✓	✓	(2 sec. Self-timer)		
✓	×	×	(Continuous Shooting)		p.79
×	×	×	(16-frame shooting)		
✓	✓	✓	AF (Standard)	Focus Mode	p.86
✓	✓	✓	(Macro)		
✓	✓	✓	PF (Pan Focus)		
✓	✓	✓	(Infinity)		
✓	×*2	×*3	Recorded Pixels		p.88
✓	✓*5	✓	Focusing Area		p.87
×*6	✓	✓	Sensitivity		p.90
✓	✓	✓	EV Compensation		p.90
✓*9	✓	✓	Zoom		p.67
✓	✓	✓	Date Imprint		p.92

*7 Fixed at ±0.0

*8 Intelligent Zoom is not available

*9 Only Optical Zoom is available

Messages







Messages such as the following may appear on the display during camera operation.

Message	Description
Battery depleted	The batteries are exhausted. Replace with new batteries. If using rechargeable batteries, charge the batteries. (p.27)
Memory card full	The SD Memory Card is full and no more images can be saved. Insert a new SD Memory Card or delete unwanted images (p.31, p.111). Change the recorded pixels of recorded images and try again (p.122).
Memory card error	Shooting and playback are impossible due to a problem with the SD Memory Card. You may be able to display or copy the images on the card using a computer.
Card is not formatted	The SD Memory Card you have inserted is unformatted or has been formatted on a computer or other device and is not compatible with this camera. Format the SD Memory Card in the camera (p.140).
The built-in memory is not formatted	The data within the built-in memory are damaged. Format the built-in memory.
Card is locked	The SD Memory Card is write-protected (p.33).
Compression error	This message occurs when the camera fails to compress an image. Change the quality level or recorded pixels of the image and try shooting or saving it again.
No image	There are no images on the SD Memory Card.
Movie recording stopped	This message appears when the internal temperature of the camera has exceeded normal operating limits while recording a movie.
Deleting	This message appears when deleting an image.
Camera cannot play this image and sound	You are trying to play back a picture or a movie in a format not supported by this camera. You may be able to play it back on another brand of camera or on your computer.
Image folder cannot be created	The largest file number (9999) has been assigned to an image in the largest folder number (999) and no more images can be saved. Insert a new SD Memory Card or format the card (p.140).
Protected	The image you are trying to delete is protected.

Message	Description
Data being recorded	This message appears when you try to switch to  mode while an image is still being recorded, or when the protect setting or DPOF setting is being changed. It disappears after the image is recorded or the setting is changed.
Data being processed	This message appears when the camera takes more than five seconds to display an image due to image processing, or when the SD Memory Card or the built-in memory is being formatted.
Built-in memory full	Displayed if the built-in memory is full when saving a file.
No image to be processed	Displayed when there are no images.
This image cannot be processed	Displayed for files that cannot be processed.
No card in the camera	Displayed when no SD Memory Card is inserted.
Available built-in memory is insufficient to copy the images	Displayed when there is insufficient built-in memory to perform copying.
Cannot process correctly	Displayed when Red-eye Compensation processing fails.
Plays back stored images in the built-in memory	Displayed when the camera enters the built-in memory display.

Troubleshooting

Problem	Cause	Remedy
The camera will not turn on	The batteries are not installed	Check if batteries are installed. If not, install batteries.
	The batteries are installed incorrectly	Check orientation of the batteries. Reinsert the batteries according to the ⊕ ⊖ symbols in the battery compartment (p.27).
	The batteries are exhausted	Insert new batteries or use the AC adapter.
No image appears on the display	The camera is connected to a computer	The display is off when the camera is connected to a computer.
	The camera is connected to a TV	The display is off when the camera is connected to a TV.
The display is hard to see	The brightness level of the display is set too dark	Adjust the brightness level in [Brightness Level] in the [⌂ Setting] menu (p.150).
	Power Saving function is on	When the Power Saving function is on, the display automatically darkens after a certain amount of time. Press a button to return to the normal brightness level. Select [Off] in [Power Saving] in the [⌂ Setting] menu to turn the Power Saving function off (p.151).
The shutter will not release	The flash is charging	Pictures cannot be taken while the flash is charging. Wait until charging is finished.
	There is no available space on the SD Memory Card or in the built-in memory	Insert an SD Memory Card with available space or delete unwanted images (p.31, 111).
	Recording	Wait until recording is finished.
The picture is dark when using the flash	The subject is too far away in a dark environment, such as a night scene	The picture becomes dark if the subject is too far away. Take pictures within the specified flash range.

Problem	Cause	Remedy
The subject is not in focus	The subject is difficult to focus on with autofocus	The camera may have difficulty in focusing on subjects such as: low contrast subjects (a white wall, a blue sky, etc.), dark subjects, finely-patterned objects, rapidly-moving objects. It is also difficult to get proper focus when shooting through a window or a net. Try shooting using the focus lock (p.58).
	The subject is not in the focusing area	Locate the desired subject in the focus frame (focusing area) in the center of the display. If it is difficult to do so, first lock the focus on the desired subject (focus lock), and then move the camera to recompose.
The flash does not discharge	The flash mode is set to  (Flash Off)	Set to Auto or  (Flash On) (p.84).
	The drive mode is set to  or  The focus mode is set to  The shooting mode is set to 	The flash does not discharge in these modes.



Very occasionally, static electricity may cause camera malfunction. In this case, remove the batteries and install them again. If the camera is then working properly, normal operation is restored and you can continue using the camera.

Default Settings

The table below lists the factory default settings.

The meaning of the indications for menu items with a default setting is explained below.

Last Memory Setting

Yes : The current setting (last memory) is saved when the camera is turned off.

No : The setting returns to the default setting when the camera is turned off.

* : The setting depends on the [Memory] setting (p.97).

— : N/A

Reset Setting

Yes : The setting returns to the default setting with the Reset function (p.153).

No : The setting is saved even after reset.



— : N/A

● [📷 Rec.Mode] Menu Items

Item		Default Setting	Last Memory Setting	Reset Setting	Page
Recorded Pixels		<input type="checkbox"/> 10M (3648×2736)	Yes	Yes	p.88
Focusing Area		<input type="checkbox"/> <input type="checkbox"/> (Multiple)	Yes	Yes	p.87
Sensitivity		Auto	*	Yes	p.90
EV Compensation		±0.0	*	Yes	p.90
Movie	Recorded Pixels	<input type="checkbox"/> 640 (640×480, 30fps)	Yes	Yes	p.94
	Movie SR	<input checked="" type="checkbox"/> (On)	Yes	Yes	p.96
Digital Zoom		<input checked="" type="checkbox"/> (On)	*	Yes	p.69
Memory	Face Detection	<input type="checkbox"/> (Off)	Yes	Yes	p.61
	Flash Mode	<input checked="" type="checkbox"/> (On)	Yes	Yes	p.84
	Drive Mode	<input type="checkbox"/> (Off)	Yes	Yes	p.78 p.79
	Focus Mode	<input type="checkbox"/> (Off)	Yes	Yes	p.86
	Zoom Position	<input type="checkbox"/> (Off)	Yes	Yes	p.67
	Sensitivity	<input type="checkbox"/> (Off)	Yes	Yes	p.90
	EV Compensation	<input type="checkbox"/> (Off)	Yes	Yes	p.90
	Digital Zoom	<input checked="" type="checkbox"/> (On)	Yes	Yes	p.69
	DISPLAY	<input type="checkbox"/> (Off)	Yes	Yes	p.18
	File No.	<input checked="" type="checkbox"/> (On)	Yes	Yes	—

Item	Default Setting	Last Memory Setting	Reset Setting	Page
Date Imprint	Off	Yes	Yes	p.92













● [Setting] Menu Items

Item		Default Setting	Last Memory Setting	Reset Setting	Page
Sound	Operation Volume	3	Yes	Yes	p.141
	Playback Volume	3	Yes	Yes	
	Start-up Sound	1	Yes	Yes	
	Shutter Sound	1	Yes	Yes	
	Operation Sound	1	Yes	Yes	
	Self-timer Sound	1	Yes	Yes	
Date Adjustment	Date Format (date)	According to initial setting	Yes	No	p.41 p.142
	Date Format (time)	24h	Yes	No	
	Date	1/1/2010	Yes	No	
	Time	According to initial setting	Yes	No	
World Time	Select Time	Same as  Hometown	Yes	Yes	p.145
	Destination (City)	According to initial setting	Yes	No	
	Destination (DST)	<input type="checkbox"/> (Off)	Yes	No	
	Hometown (City)	According to initial setting	Yes	No	
	Hometown (DST)	<input type="checkbox"/> (Off)	Yes	No	
Language/ 言語		According to initial setting	Yes	No	p.37 p.147
Folder Name		Date	Yes	Yes	p.148
USB Connection		MSC	Yes	Yes	p.161
Video Out		According to initial setting	Yes	No	p.149
Brightness Level			Yes	Yes	p.150
Power Saving		5 sec.	Yes	Yes	p.151
Auto Power Off		3 min.	Yes	Yes	p.152
Reset		Cancel	—	—	p.153
Delete all		Cancel	—	—	p.114
Format		Cancel	—	—	p.140

● Playback Mode Palette Items

Item		Default Setting	LastMemory Setting	Reset Setting	Page
Slideshow	Interval	3 sec.	Yes	Yes	p.106
	Screen Effect	Wipe	Yes	Yes	
	Sound Effect	<input checked="" type="checkbox"/> (On)	Yes	Yes	
Resize	Recorded Pixels	Depending on the picture taken	—	—	p.122
Cropping		Depending on the picture taken	—	—	p.123
Image Copy		Built-in memory → SD Memory Card	—	—	p.133
Image Rotation		Normal	—	—	p.108
Digital Filter		B&W	No	—	p.125
Frame Composite		Default1	Yes	Yes	p.129
Red-eye Compensation		—	—	—	p.128
Protect	Single Image	Depending on the recorded image	—	—	p.116
	All Images	Depending on the recorded image	—	—	
DPOF	Single Image	Copies: 0	—	—	p.135
	All Images	Date: <input type="checkbox"/> (Off)	—	—	
Image Recovery		Cancel	—	—	p.115

● Key Operation

Item	Function	Default Setting	LastMemory Setting	Reset Setting	Page
 button	Operation Mode	 mode	—	—	—
Zoom button	Zoom Position	Full wide-angle	*	No	p.67
Four-way controller	 Drive Mode	 (Standard)	*	Yes	p.78 p.79
	 Shooting Mode	 (Auto Picture)	Yes	Yes	p.59
	 Flash Mode	 (Auto)	*	Yes	p.84
	 Focus Mode	AF (Standard)	*	Yes	p.86
MENU button	Menu Display	Capture mode:  [Rec.Mode] menu Playback mode:  [Setting] menu	—	—	p.49
OK/DISPLAY button	Information Display	Normal	*	Yes	p.18
 button	Operation Mode	Face Detection On	*	Yes	p.61

List of World Time Cities

City: indicates cities that can be set as either the Initial Setting (p.37) or the World Time (p.145).
Video Output Format: indicates the video output format of the city set as the Initial Setting.

Region	City	Video Output Format	Region	City	Video Output Format
North America	Honolulu	NTSC	Africa/ West Asia	Istanbul	PAL
	Anchorage	NTSC		Cairo	PAL
	Vancouver	NTSC		Jerusalem	PAL
	San Francisco	NTSC		Nairobi	PAL
	Los Angeles	NTSC		Jeddah	PAL
	Calgary	NTSC		Tehran	PAL
	Denver	NTSC		Dubai	PAL
	Chicago	NTSC		Karachi	PAL
	Miami	NTSC		Kabul	PAL
	Toronto	NTSC		Male	PAL
	New York	NTSC		Delhi	PAL
Halifax	NTSC	Colombo		PAL	
Central and South America	Mexico City	NTSC		Kathmandu	PAL
	Lima	NTSC		Dacca	PAL
	Santiago	NTSC	East Asia	Yangon	NTSC
	Caracas	NTSC		Bangkok	PAL
	Buenos Aires	PAL		Kuala Lumpur	PAL
	Sao Paulo	PAL		Vientiane	PAL
Rio de Janeiro	NTSC	Singapore		PAL	
Europe	Lisbon	PAL		Phnom Penh	PAL
	Madrid	PAL		Ho Chi Minh	PAL
	London	PAL		Jakarta	PAL
	Paris	PAL		Hong Kong	PAL
	Amsterdam	PAL		Beijing	PAL
	Milan	PAL		Shanghai	PAL
	Rome	PAL		Manila	NTSC
	Copenhagen	PAL		Taipei	NTSC
	Berlin	PAL		Seoul	NTSC
	Prague	PAL	Tokyo	NTSC	
	Stockholm	PAL	Guam	NTSC	
	Budapest	PAL	Oceania	Perth	PAL
	Warsaw	PAL		Adelaide	PAL
	Athens	PAL		Sydney	PAL
	Helsinki	PAL		Noumea	PAL
Moscow	PAL	Wellington		PAL	
Africa/ West Asia	Dakar	PAL		Auckland	PAL
	Algiers	PAL		Pago Pago	NTSC
	Johannesburg	PAL			

Optional Accessories

A number of dedicated accessories are available for this camera. Products marked with an asterisk (*) are the same as those supplied with the camera.

- **Power supply**

- AC adapter kit K-AC62**

- (AC adapter D-AC62, DC coupler D-DC51, AC plug cord)

- **Cable**

- USB cable I-USB98 (*)**

- AV cable I-AVC7**

- **Strap**

- O-ST86 (*)**

- O-ST24** Genuine leather strap

- O-ST8** Silver chain strap

- O-ST81** Waterproof strap

- **Camera case**

- O-CC81**

Main Specifications

Type	Fully automatic compact digital still camera with built-in zoom lens
Number of Effective Pixels	Approx. 10.1 megapixels
Image Sensor	1/2.3 inch CCD
Number of Recorded Pixels	Still $\frac{10M}{10M}$ (3648×2736 pixels), $\frac{7M}{7M}$ (3072×2304 pixels), $\frac{5M}{5M}$ (2592×1944 pixels), $\frac{3M}{3M}$ (2048×1536 pixels), $\frac{2.1M}{2.1M}$ (16:9) (1920×1080 pixels), $\frac{1024}{1024}$ (1024×768 pixels), $\frac{640}{640}$ (640×480 pixels) <ul style="list-style-type: none">* Fixed at $\frac{3M}{3M}$ (2048×1536) in Half-length Portrait mode.* Fixed at $\frac{3M}{3M}$ (2048×1536) in Frame Composite mode.* Fixed at $\frac{2M}{2M}$ (1600×1200) for one frame in Digital Panorama mode.* Fixed at $\frac{640}{640}$ (640×480) per one frame, and 2560×1920 per one picture in 16-frame shooting mode.
	Movie $\frac{640}{640}$ (640×480 pixels, 30fps), $\frac{640}{640}$ (640×480 pixels, 15fps), $\frac{320}{320}$ (320×240 pixels, 30fps), $\frac{320}{320}$ (320×240 pixels, 15fps) (recorded pixels, frame rate)
Sensitivity (Standard Output Sensitivity)	Auto ISO 100 - 800, Fixed (ISO 100 - 1600) * The sensitivity is fixed at Auto (ISO 100-1600) in the Digital SR.
File Format	Still JPEG (Exif 2.2), DCF 2.0, DPOF, PRINT Image Matching III Movie AVI (Motion JPEG), approx. 30fps/15fps, PCM system, monaural sound, full color, Movie SR (Movie Shake Reduction)
Storage Media	Built-in memory (approx. 6 MB), SD Memory Card, SDHC Memory Card

Approximate Image Storage Capacity and Recording Time Still Pictures

		Built-in Memory	512 MB
10M	3648×2736	1 picture	120 pictures
10M	3648×2736	4 pictures	241 pictures
7M	3072×2304	5 pictures	301 pictures
5M	2592×1944	6 pictures	371 pictures
3M	2048×1536	7 pictures	603 pictures
2.1M	1920×1080	15 pictures	805 pictures
1024	1024× 768	36 pictures	1859 pictures
640	640× 480	68 pictures	3453 pictures

- The image storage capacity is for reference only. The actual image storage capacity may vary depending on the SD Memory Card and the subject.

Movie

		Built-in Memory	512 MB
640	640×480, 30fps	10 sec.	8 min. 57 sec.
640	640×480, 15fps	21 sec.	17 min. 54 sec.
320	320×240, 30fps	21 sec.	22 min. 54 sec.
320	320×240, 15fps	43 sec.	35 min. 48 sec.

- The above figures are based on our standard shooting conditions and may vary depending on the subject, shooting conditions and type of the SD Memory Card used.
- Recording can continue until the built-in memory or the SD Memory Card is full, or the size of the recorded movie reaches 2 GB (when using an SDHC card). If recording stops at 2 GB, start recording again to continue to record the rest of the movie in blocks of 2 GB.

White Balance	Auto	
Lens	Focal Length	5.7 mm - 17.1 mm (approx. 31.5 mm - 94.5 mm in 35mm equivalent focal length)
	Aperture	F2.9 (W) - F5.2 (T)
	Lens Composition	7 elements in 6 groups (3 aspherical elements)
Optical Zoom	3×	
Intelligent Zoom	Approx. 3.6× at 7M (3072×2304), Approx. 17.1× at 640 (640×480) (when combined with optical zoom)	
Digital Zoom	Max. Approx. 5.7× (combines with 3× optical zoom to give zoom magnification equivalent to Approx. 17.1×)	
Motion Blur Reduction	Still	Hi-sensitivity shake reduction mode (Digital SR)
	Movie	Movie shake reduction (Movie SR)

Display	2.7 inch LCD, approx. 230,000 dots	
Playback modes	Single-frame, 4-frame Index, 9-frame Index, Enlargement (max. 10 \times , scrollable), Face Close-up Playback, Folder Display, Calendar Display, Deleting Selected Images, Slideshow, Digital Filter, Frame Composite, Resize, Cropping, Image Copy, Image Rotation, Red-eye Compensation, Protect, DPOF, Image Recovery, Movie Playback	
Focus Modes	Autofocus, Macro, Pan Focus, Infinity	
Focus	Type	3-point autofocus (multiple/spot/automatic tracking AF changeable)
	Focus range (From lens face)	Standard : 0.5 m - ∞ (Wide-angle) 0.5 m - ∞ (Telephoto)
		Macro : 0.1 m - 0.6 m (Wide-angle) 0.35 m - 0.6 m (Telephoto)
	* It is possible to switch to Infinity and Pan Focus. * Face Detection AF is available only while the camera detects the subject's face.	
Focus Lock	By half-pressing the shutter release button	
Exposure control	Metering System	Multi-segment metering
	Exposure Compensation	± 2 EV (can be set in 1/3 EV steps)
Face Detection	Detection of up to 10 people's faces (up to 10 faces in the face detection frame on the display), Smile Capture	
Shooting modes	Auto Picture, Program, Night Scene, Night Scene Portrait, Half-length Portrait, Movie, Landscape, Flower, Portrait, Surf & Snow, Sport, Digital SR, Kids, Sunset, Pet, Food, Natural Skin Tone, Candlelight, Frame Composite, Digital Panorama, Green * Face Detection AE is available only while the camera detects the subject's face.	
Digital Filters	B&W, Sepia, Fish-eye, Starburst (Cross/Heart/Star), Color (Red/Pink/Purple/Blue/Green/Yellow), Brightness	
Movie	Continuous Recording Time	Approx. 1 second - until built-in memory or SD Memory Card is full (however, maximum size is limited to 2 GB)
Shutter Speed	1/2000 sec. - 1/4 sec., max. 4 sec.	
Built-in Flash	Modes	Auto, Flash Off, Flash On, Flash On + Red-eye
	Flash Range	Wide-angle: approx. 0.1 m - 5.4 m (approx. 0.33 ft - 17.72 ft) (Sensitivity: in Auto condition) Telephoto: approx. 0.35 m - 3.0 m (approx. 1.15 ft - 9.84 ft) (Sensitivity: in Auto condition)
Drive Modes	Single-frame, Self-timer (approx. 10 sec., approx. 2 sec.), Continuous and 16-frame shooting	
Self-timer	Electronic control type, control time: Approx. 10 sec., 2 sec.	
Time Function	World Time	75 cities (28 time zones)
Power Source	Two AA (alkaline, lithium or Ni-MH) batteries, AC adapter kit (optional)	

Battery Life	Number of Recordable Images approx. 220 pictures	* Recording capacity shows approximate number of shots recorded during CIPA-compliant testing (with display on, flash used for 50% of the shots, and 23 degrees centigrade). Actual performance may vary according to operating conditions.
	Playback Time approx. 400 min.	* According to the result of in-house testing. Actual time may differ depending on usage conditions.
	Movie Recording Time approx. 100 min.	* According to the result of in-house testing. Actual time may differ depending on usage conditions.
Interfaces	USB/AV terminal	
Video Output	NTSC/PAL (monaural)	
Dimensions	Approx. 92.5 (W) × 60.0 (H) × 28.0 (D) mm (excluding operating or protruding parts)	
Weight	Approx. 122 g (excluding batteries and SD Memory Card)	
	Approx. 170 g (including batteries and SD Memory Card)	
Accessories	Two AA alkaline batteries, USB cable, software (CD-ROM), strap, Operating Manual, Quick Guide	

WARRANTY POLICY

All PENTAX cameras purchased through authorized bona fide photographic distribution channels are guaranteed against defects of material or workmanship for a period of twelve months from date of purchase. Service will be rendered, and defective parts will be replaced without cost to you within that period, provided the equipment does not show evidence of impact, sand or liquid damage, mishandling, tampering, battery or chemical corrosion, operation contrary to operating instructions, or modification by an unauthorized repair shop. The manufacturer or its authorized representatives shall not be liable for any repair or alterations except those made with its written consent and shall not be liable for damages from delay or loss of use or from other indirect or consequential damages of any kind, whether caused by defective material or workmanship or otherwise; and it is expressly agreed that the liability of the manufacturer or its representatives under all guarantees or warranties, whether expressed or implied, is strictly limited to the replacement of parts as hereinbefore provided. No refunds will be made on repairs by non-authorized PENTAX service facilities.

Procedure During 12-month Warranty Period

Any PENTAX which proves defective during the 12-month warranty period should be returned to the dealer from whom you purchased the equipment or to the manufacturer. If there is no representative of the manufacturer in your country, send the equipment to the manufacturer, with postage prepaid. In this case, it will take a considerable length of time before the equipment can be returned to you owing to the complicated customs procedures required. If the equipment is covered by warranty, repairs will be made and parts replaced free of charge, and the equipment will be returned to you upon completion of servicing. If the equipment is not covered by warranty, regular charges of the manufacturer or of its representatives will apply. Shipping charges are to be borne by the owner. If your PENTAX was purchased outside of the country where you wish to have it serviced during the warranty period, regular handling and servicing fees may be charged by the manufacturer's representatives in that country. Notwithstanding this, your PENTAX returned to the manufacturer will be serviced free of charge according to this procedure and warranty policy. In any case, however, shipping charges and customs clearance fees to be borne by the sender. To prove the date of your purchase when required, please keep the receipt or bills covering the purchase of your equipment for at least a year. Before sending your equipment for servicing, please make sure that you are sending it to the manufacturer's authorized representatives or their approved repair shops, unless you are sending it directly to the manufacturer. Always obtain a quotation for the service charge, and only after you accept the quoted service charge, instruct the service station to proceed with the servicing.

- This warranty policy does not affect the customer's statutory rights.
- The local warranty policies available from PENTAX distributors in some countries can supersede this warranty policy. Therefore, we recommend that you review the warranty card supplied with your product at the time of purchase, or contact the PENTAX distributor in your country for more information and to receive a copy of the warranty policy.



The CE Mark is a Directive conformity mark of the European Union.

For customers in USA

STATEMENT OF FCC COMPLIANCE

This device complies with Part 15 of the FCC Rules. Operation is subject to the following two conditions: (1) This device may not cause harmful interference, and (2) this device must accept any interference received, including interference that may cause undesired operation.

Changes or modifications not approved by the party responsible for compliance could void the user's authority to operate the equipment.

This equipment has been tested and found to comply with the limits for a Class B digital device, pursuant to part 15 of the FCC Rules.

These limits are designed to provide reasonable protection against harmful interference in a residential installation. This equipment generates, uses and can radiate radio frequency energy and, if not installed and used in accordance with the instructions, may cause harmful interference to radio communications. However, there is no guarantee that interference will not occur in a particular installation.

If this equipment does cause harmful interference to radio or television reception, which can be determined by turning the equipment off and on, the user is encouraged to try to correct the interference by one or more of the following measures:

- Reorient or relocate the receiving antenna.
Increase the separation between the equipment and receiver.
Connect the equipment into an outlet on a circuit different from that to which the receiver is connected.
- * Consult the dealer or an experienced radio/TV technician for help.

For customers in Canada

This Class B digital apparatus complies with Canadian ICES-003.

Pour les utilisateurs au Canada

Cet appareil numérique de la classe B est conforme à la norme NMB-003 du Canada.

FOR CALIFORNIA, U.S.A. ONLY

Perchlorate Material-special handling may apply. The lithium battery used in this camera contains perchlorate material, which may require special handling. See www.dtsc.ca.gov/hazardouswaste/perchlorate

Declaration of Conformity

According to 47CFR, Parts 2 and 15 for
Class B Personal Computers and Peripherals

We: PENTAX Imaging Company
A Division of PENTAX of America, Inc.

Located at: 600 12th Street, Suite 300
Golden, Colorado 80401 U.S.A.
Phone: 303-799-8000 FAX: 303-790-1131

Declare under sole responsibility that the product identified herein complies with 47CFR Parts 2 and 15 of the FCC rules as a Class B digital device. Each product marketed is identical to the representative unit tested and found to be compliant with the standards. Records maintained continue to reflect the equipment being produced can be expected to be within the variation accepted, due to quantity production and testing on the statistical basis as required by 47CFR §2.909. Operation is subject to the following two conditions: (1) This device may not cause harmful interference, and (2) This device must accept any interference received, including interference that may cause undesired operation. The above named party is responsible for ensuring that the equipment complies with the standards of 47CFR §15.101 to §15.109.

Product Name: PENTAX Digital Still Camera

Model Number: Optio E90

Contact person: Customer Service Manager

Date and Place: February, 2010, Colorado

Information for Users on Collection and Disposal of Old Equipment and Used Batteries



1. In the European Union

These symbols on the products, packaging and/or accompanying documents mean that used electrical and electronic equipments and batteries should not be mixed with general household waste.

Used electrical/electronic equipments and batteries must be treated separately and in accordance with legislation that requires proper treatment, recovery and recycling of these products.

Following the implementation by member states, private households within the EU states may return their used electrical/electronic equipments and batteries to designated collection facilities free of charge*.

In some countries your local retailer may also take back your old product free of charge if you purchase a similar new one.

*Please contact your local authority for further details.



By disposing of this product correctly you will help ensure that the waste undergoes the necessary treatment, recovery and recycling and thus prevent potential negative effects on the environment and human health which could otherwise arise due to inappropriate waste handling.

2. In other countries outside the EU

These symbols are only valid in the European Union. If you wish to discard these items, please contact your local authorities or dealer and ask for the correct method of disposal.





































For Switzerland: Used electrical/electronic equipment can be returned free of charge to the dealer, even when you

Cd

don't purchase a new product. Further collection facilities are listed on the home page of www.swico.ch or www.sens.ch.

Note for the battery symbol (bottom two symbol examples): This symbol might be used in combination with a designation for the chemical element or compound in use. In this case you have to comply with the requirement set by the Directive for the chemicals involved.

Symbols

 mode	10, 48
 mode	10, 48
 button	44, 46
 button	44, 47
[ Rec.Mode]	
menu	53, 178
[ Setting] menu	54, 179
 Green Mode	66
 Delete	100, 111
 Magnify	109
 Four-image display	102
 Nine-image display	102
 Self-timer	78
 Continuous Shooting	79
 16-frame shooting	79
 Auto Picture	63
 Program	64
 Night Scene	70
 Night Scene Portrait	70
 Half-length Portrait	71
 Movie	94
 Landscape	60
 Flower	60
 Portrait	71
 Natural Skin Tone	71
 Surf & Snow	74
 Sport	74
 Digital SR	70
 Kids	72
 Sunset	70
 Candlelight	70
 Pet	73
 Food	60
 Frame Composite	76
 Digital Panorama	81

Numerics

16-frame shooting 	79
---	----

A

AC adapter	29
Auto Picture Mode	63
Auto Power Off	152
Auto 	84
Auto-Macro function	86
Automatic Tracking	
AF	61, 74, 87
AV cable	119
AV equipment	119

B

B&W filter	125
Basic mode	66
Battery level indicator	29
Brightness filter	125
Brightness Level	150
Built-in memory	133
Built-in memory display	48

C

Calendar display	103
Camera shake	18, 68
Candlelight Mode	70
Capture Mode Palette	59
Changing volume	141
Checking the Memory	
Card	35
City name	182
Color filter	125
Connecting to a TV	119
Continuous Shooting 	79
Copy	133
Cropping	123





D

Date and time setting	41, 142
Date Imprint	92
Daylight saving time	40
Default setting	37, 178
Delete 	100, 111
Destination	145
Digital Filter	125
Digital SR	70
Digital Zoom	67, 69
Display brightness	150
Display Language	147
DPOF settings	135
Drive Mode	78, 79

E

Error messages	174
Exposure setting	90

F

Face close-up playback ...	110
Face Detection	61
File number	97
Filters	125
Fish-eye filter	125
Flash Mode	84
Flash Off 	84
Flash On + Red-eye 	84
Flash On 	84
Flower Mode	60
Focus Mode	86
Focusing	86
Focusing Area	87
Folder display	103
Folder Name	148
Food Mode	60
Format	140
Four-image display 	102
Four-way controller	45, 47

Frame Composite	76, 129
-----------------------	---------

G

Green Button	45, 47
Green Mode	66
Guide Indications	23

H

Half-length Portrait Mode	71
Hometown	40, 145

I

Image Recovery	115
Image Storage Capacity	185
Infinity 	86
Info Display	20
Installing a battery	27
Installing the Software	158
Intelligent zoom	67



K

Kids Mode	72
-----------------	----

L

Landscape Mode	60
Language setting	37, 147

M

Macintosh	157
Macro 	86
Magnify 	109
MediaImpression	156
Memory	97
MENU button	45, 47
Movie	93
Movie SR (Movie Shake Reduction) Function	96
MSC	162

N	
Natural Skin Tone Mode	71
Night Scene Mode	70
Night Scene Portrait Mode	70
Nine-image display 	102
NTSC	149
Number of pixels	88

O

OK/DISPLAY button	45, 47
Operating the Menus	49
Optional accessory	183

P

PAL	149
Pan Focus PF	86
Panoramic Pictures	81
Pet Mode	73
Photo processing lab	135
Playback	100, 101
Playback Mode	36
Playback Mode	
Palette	104, 180
Playing back movies	101
Portrait Mode	71
Power Saving	151
Power switch	35, 44, 46
Press fully (shutter release button)	57
Press halfway (shutter release button)	57
Product Registration	160
Program Mode	64
Protect 	116
Provided Software	156
PTP	162

R

Rec.Mode Menu	53, 178
Rec.Mode Palette	59

Recorded Pixels	88, 94
Recording movies	93
Recovering images	115
Red-eye Compensation	128
Red-eye reduction 	84
Reset	153
Resize	122
Rotating	108

S

Saving pictures by date	148
Saving settings	97
Screen Effect	107
SD Memory Card	31
Select Time	146
Self-timer 	78
Sensitivity	90
Sepia filter	125
Setting Menu	54, 179
Shooting information	19
Shooting Mode	59
Shutter release button	44, 46, 57
Slideshow	106
Smile Capture	62
Sound settings	141
Sound types	142
Specifications	184
Sport Mode	74
Standard AF	86
Starburst filter	125
Strap	26
Sunset Mode	70
Surf & Snow Mode	74
System Requirements	156

T

Tele	67
Time imprint	92
TV	119

U

USB Connection 161

V

Video output format 149

W

Wide 67

Windows 157

World Time 145

Z

Zoom 67

Zoom button 44

Memo

Memo

HOYA CORPORATION

PENTAX Imaging Systems Division

2-35-7, Maeno-cho, Itabashi-ku, Tokyo 174-8639, JAPAN
(<http://www.pentax.jp>)

**PENTAX Europe GmbH
(European Headquarters)**

Julius-Vosseler-Strasse 104, 22527 Hamburg, GERMANY
(HQ - <http://www.pentaxeurope.com>)
(Germany - <http://www.pentax.de>)

PENTAX U.K. Limited

PENTAX House, Heron Drive, Langley, Slough, Berks
SL3 8PN, U.K.
(<http://www.pentax.co.uk>)

PENTAX France S.A.S.

112 Quai de Bezons, B.P. 204, 95106 Argenteuil
Cedex, FRANCE
(<http://www.pentax.fr>)

PENTAX Imaging Company

A Division of PENTAX of America, Inc.

(Headquarters)
600 12th Street, Suite 300 Golden, Colorado 80401, U.S.A.
(PENTAX Service Department)
250 North 54th Street Chandler, AZ 85226, U.S.A.
(<http://www.pentaximaging.com>)

PENTAX Canada Inc.

1770 Argentia Road Mississauga, Ontario L5N 3S7,
CANADA (<http://www.pentax.ca>)

**PENTAX Trading
(SHANGHAI) Limited**

23D, Jun Yao International Plaza, 789 Zhaojiabang
Road, Xu Hui District, Shanghai, 200032 CHINA
(<http://www.pentax.com.cn>)

<http://www.pentax.jp/english>

- Specifications and external dimensions are subject to change without notice.

Free Manuals Download Website

<http://myh66.com>

<http://usermanuals.us>

<http://www.somanuals.com>

<http://www.4manuals.cc>

<http://www.manual-lib.com>

<http://www.404manual.com>

<http://www.luxmanual.com>

<http://aubethermostatmanual.com>

Golf course search by state

<http://golfingnear.com>

Email search by domain

<http://emailbydomain.com>

Auto manuals search

<http://auto.somanuals.com>

TV manuals search

<http://tv.somanuals.com>