

# PENTAX™

Digital Camera

# Optio S4

## Operating Manual

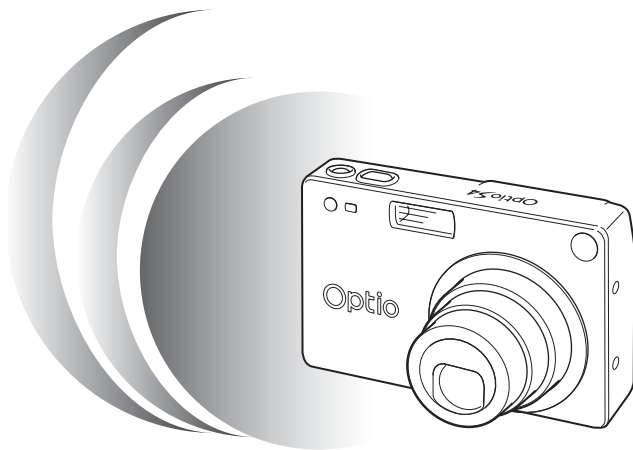

To ensure the best performance from your camera, please read the Operating Manual before using the camera.

Thank you for buying the Pentax Optio S4 Digital Camera. Please read this manual before using the camera in order to get the most out of all the features and functions. Keep this manual safe, as it can be a valuable tool in helping you to understand all the camera's capabilities.

### **Regarding copyrights**

Images taken using the Optio S4 that are for anything other than personal enjoyment cannot be used without permission according to the rights as specified in the Copyright Act. Please take care, as there are even cases where limitations are placed on taking pictures even for personal enjoyment during demonstrations, industrial enterprise or as items for display. Images taken with the purpose of obtaining copyrights also cannot be used outside the scope of use of the copyright as laid out in the Copyright Act, and care should be taken here also.

### **Regarding trademarks**

- The SD logo  is a trademark.
- PENTAX is a trademark of PENTAX Corporation.
- Optio is a trademark of PENTAX Corporation.
- All other brands or product names are trademarks of registered trademarks of their respective companies.
- The USB driver uses software developed by inSilicon Corporation. Copyright © 2002 inSilicon Corporation. All rights reserved.
- This product supports PRINT Image Matching II. When used in combination, PRINT Image Matching II enabled digital still cameras, printers and software help photographers to produce images more faithful to their intentions. Copyright 2001 Seiko Epson Corporation. All Rights Reserved. PRINT Image Matching is a trademark of Seiko Epson Corporation.

## FOR SAFE USE OF YOUR CAMERA

Sufficient attention has been paid to the safety of this product but please pay particular attention to the warnings indicated by the following symbols during use.



### **Warning**

These symbols indicate that it is possible that the user may experience serious difficulties if the warnings are not heeded.



### **Caution**

These symbols indicate that it is possible that the user may experience minor or middling difficulties or physical difficulties if the warnings are not heeded.



### **Warning**

- Do not attempt to take the camera apart or remodel the camera. High voltages are present within the camera, and there is therefore a danger of electric shocks.
- If the inside of the camera should become exposed as a result of, for example, the camera being dropped, please do not under any circumstances touch such exposed portions, as there is a danger of receiving an electric shock.
- Wrapping the strap of the camera around your neck is also dangerous, please take care that small children do not hang the strap around their necks.
- To avoid the risk of it being swallowed by mistake, keep the SD Memory Card / MultiMediaCard out of the reach of small children. Seek medical attention immediately if accidentally swallowed.
- Use an AC adapter that are of the power and voltage specified for exclusive use with this product. The use of an AC adapter other than that specified exclusively for use with this product may cause fire or electric shocks.
- If the camera emits smoke or a strange smell, or in the event of any other irregularity, stop using the camera immediately, remove the battery or disconnect the AC adapter and contact your nearest Pentax service center. Continued use of the camera may result in fire or electric shock.
- Discontinue use of the AC adapter during thunderstorms. This can cause a fire or electrical shock.

## **Caution**

- Never try to disassemble, short the battery. Also, do not dispose of the battery in fire, as it may explode.
- Remove the battery from the camera immediately if it becomes hot or begins to smoke. Be careful not to burn yourself during removal.
- Some portions of the camera heat up during use, so please take care, as there is a risk of low temperature burns if such portions are held for long periods of time.
- Do not place your finger on the flash when it is discharging as there is a risk of burns.
- If any of the battery leakage should come in contact with your eyes, do not rub them. Flush your eyes with clean water and get medical attention immediately.
- If any of the battery leakage should come in contact with skin or clothes, wash the affected areas thoroughly with water.

## **Care to be Taken During Handling**

- Do not clean the product with organic solvents such as thinner or alcohol benzene.
- Places of high temperature and humidity should be avoided. Particular care should be taken regarding vehicles, which can become very hot inside.
- Storing the camera where pesticides and chemicals are handled should be avoided.

Remove from case and store in a well-ventilated place to prevent the camera from becoming moldy during storage.

- Do not use the camera where it may come in contact with rain, water or any other liquid, because the camera is not weather, water, or liquid resistant. Should the camera get wet from rain, splashing water, or any other liquid, wipe it off immediately with a dry soft cloth.
- Ensure that the camera is not subjected to substantial vibrations, shocks or pressure.

Place the camera on a cushion for protection when the camera is subjected to the vibrations of a motorbike, car, or ship, etc.

- The liquid crystal display will become black at temperatures of approximately 60°C (140°F) but will return to normal when normal temperatures are returned to.
- The response speed of the liquid crystal display becomes slow at low temperatures.

- This is due to the properties of the liquid crystal and is not a fault.
- Remove dust from the lens and viewfinder using a blower or clean off dust using a lens brush.
- Periodic checks are recommended every 1 to 2 years in order to maintain high-performance.
- When the camera has not been used for a long time, confirm that it is still working properly, particularly prior to taking important pictures (such as at a wedding or during travelling). Pentax is not responsible for consequential damages (costs incurred as a result of taking pictures, loss of benefits that were to be obtained through taking pictures) arising from failure of this product.
- If the camera is subjected to rapid temperature changes, condensation may form on the inside and outside of the camera. Therefore put the camera in a bag or plastic bag, and take the camera out when the difference in temperature has subsided.
- The temperature range in which the camera can be used is 0°C to 40°C (32°F to 104°F).
- Avoid contact with garbage, dirt, sand, dust, water, toxic gases, salt, etc. as this may cause damage to the camera. If rain or drops of water get onto the camera, please wipe dry.
- Refer to "Precautions When Using an SD Memory Card / MultiMediaCard" (p.17) regarding the SD Memory Card / MultiMediaCard.
- Be sure to use the rechargeable lithium-ion battery D-LI8 provided for this camera. If you use any other battery the camera may be damaged or malfunction.

### **To users of this camera**

- There is a possibility that recorded data may be erased or that the camera may not function correctly when used in surroundings such as installations generating strong electromagnetic radiation or magnetic fields.
- The liquid crystal panel used in the LCD display is manufactured using extremely high precision technology. Although the level of functioning pixels is 99.99% or better, you should be aware that 0.01% or fewer of the pixels may not illuminate or may illuminate when they should not. However, this has no effect on the recorded image.
- There is a possibility that the illustrations and the display screen of the LCD monitor in this manual are different from the actual product.

# Contents

FOR SAFE USE OF YOUR CAMERA .....	1
Care to be Taken During Handling .....	2
Contents .....	4
Contents of the Operating Manual .....	7
Checking the Contents of the Package .....	8
Names of Parts .....	9
Names of Operating Parts .....	10
<b>Getting Started</b> .....	<b>11</b>
<b>Attaching the Strap</b> .....	<b>11</b>
<b>Powering the Camera</b> .....	<b>12</b>
Charging the Battery .....	12
Installing the Battery .....	13
Using the AC Adapter (optional) .....	15
<b>Installing the SD Memory Card / MultiMediaCard</b> .....	<b>16</b>
<b>Initial Settings</b> .....	<b>18</b>
Setting the Display Language .....	18
Setting the Home Town .....	19
Setting the D.S.T. Mode .....	19
Setting the Date and Time .....	20
<b>Quick Start</b> .....	<b>22</b>
<b>Taking Still Pictures</b> .....	<b>22</b>
<b>Playing Back Still Pictures</b> .....	<b>24</b>
Playing Back Images .....	24
Playing Back Previous or Next Images .....	24
Rotating a Displayed Image .....	24
<b>How to View the Recorded Images</b> .....	<b>26</b>
<b>Common Operations</b> .....	<b>28</b>
<b>Turning the Camera On and Off</b> .....	<b>28</b>
Playback Only Mode .....	28
Voice Recorder Mode .....	28
<b>Using the Button Functions</b> .....	<b>29</b>
Capture Mode .....	29
Playback Mode .....	30
Voice Recorder Mode .....	31
<b>Setting the Menus</b> .....	<b>32</b>
How to Set the Menus .....	32
Menu List .....	34
<b>Taking Pictures</b> .....	<b>36</b>
<b>Setting the Shooting Functions</b> .....	<b>36</b>
Changing the Mode .....	36
Selecting the Focus Mode .....	37

Selecting the Flash Mode .....	39
Displaying Shooting Information in Capture Mode .....	40
Selecting the Recorded Pixels .....	41
Selecting the Quality Levels .....	42
Adjusting the Color Balance according to Lighting (White Balance) .....	43
Changing the AF Area (Focusing Area) .....	45
Setting the Light Metering Range to Determine the Exposure (AE Metering) .....	46
Setting the Sensitivity .....	47
Setting the Instant Review time (Instant Review) .....	48
Setting the Image Sharpness (Sharpness) .....	49
Setting the Color Saturation (Saturation) .....	50
Setting the Image Contrast (Contrast) .....	51
EV Compensation .....	52
<b>Taking Pictures .....</b>	<b>53</b>
Setting the Functions (Program Mode) .....	53
Selecting the Picture Mode According to the Shooting Scene (Picture mode) .....	54
Taking Pictures of Dark Scenes (Night-Scene Mode) .....	55
Taking Movie Pictures (Movie Picture Mode) .....	56
Taking Panorama Pictures (Panorama Assist Mode) .....	58
Taking Pictures with Digital Filters (Digital Filter Mode) .....	60
Using Preset Function Settings (User Mode) .....	62
Taking Stereo Pictures (3D Image Mode) .....	63
Continuous Shooting (Continuous Shooting Mode) .....	68
Using the Self-Timer .....	69
Using the Remote Control Unit (optional) .....	70
Using the Zoom .....	71
Taking Time-lapse Movie Pictures (Fast Fwd Movie) .....	73
<b>Saving the Settings (Memory) .....</b>	<b>74</b>
Saving the Menu Items (Memory) .....	74
Register Functions in User Mode .....	75
<b>Recording and Playback .....</b>	<b>76</b>
<hr/>	
<b>Recording Sound (Voice Recorder Mode) .....</b>	<b>76</b>
<b>Playing Back Sound .....</b>	<b>77</b>
<b>Adding a Voice Memo .....</b>	<b>78</b>
Setting the Record Voice Memo to [Off] .....	78
<b>Playback/Erasing/Editing .....</b>	<b>79</b>
<hr/>	
<b>Playing Back Images .....</b>	<b>79</b>
Playing Back Still Pictures .....	79
Zoom Display .....	79

Playing Back Movie Pictures .....	80
Displaying shooting information in Playback mode .....	81
Nine Image Display .....	82
Slideshow .....	83
<b>Erasing Images .....</b>	<b>84</b>
Erasing a Single Image or Voice Memo .....	84
Erasing All Images .....	86
Protecting Images / sound from Deletion (Protect).....	87
<b>Viewing Images on a TV .....</b>	<b>88</b>
<b>Setting the Printing Service (DPOF).....</b>	<b>89</b>
Printing Single Image .....	89
Printing All Images.....	91
<b>Editing Images .....</b>	<b>92</b>
Changing the Image Size .....	92
Trimming Images.....	94
<b>Copying Files .....</b>	<b>95</b>
<b>Settings .....</b>	<b>96</b>
<hr/>	
<b>Camera Settings.....</b>	<b>96</b>
Formatting a SD Memory Card / MultiMediaCard and the Built-in memory.....	96
Changing the Sound Settings .....	97
Changing the Start-up Screen .....	98
Setting the Date Style .....	99
Changing the Date/Time.....	100
Setting the World Time .....	100
Changing the Display Language .....	102
Changing the Video Output Format.....	103
Sleep Timeout .....	104
Setting Auto Power Off .....	104
Setting the Quick Delete Function .....	105
Setting the Quick Zoom Function .....	105
Registering Functions .....	106
Resetting to Default Settings (Reset) .....	107
<b>Setting the Alarm .....</b>	<b>108</b>
Checking the Alarm .....	108
Setting the Alarm .....	108
Turning the Alarm Off .....	109
<b>Appendix .....</b>	<b>110</b>
<hr/>	
<b>List of City Names.....</b>	<b>110</b>
<b>Optional Accessories .....</b>	<b>111</b>
<b>Messages.....</b>	<b>112</b>
<b>Troubleshooting.....</b>	<b>114</b>
<b>Main Specifications .....</b>	<b>116</b>
<b>WARRANTY POLICY.....</b>	<b>118</b>



# Contents of the Operating Manual

This operating manual contains the following chapters.

## 1 Getting Started

This chapter explains what you need to do after purchasing the camera before you start taking pictures. Be sure to read it and follow the instructions.

## 2 Quick Start

This chapter explains the simplest way to take pictures and play back images. Use it if you want to start taking pictures straightaway. It also tells you how to use the SD Memory Card / MultiMediaCard.

## 3 Common Operations

This chapter explains common operations such as the functions of the buttons and how to use the menus. For more details, refer to the respective [Taking Pictures], [Recording and Playback], [Playback/Erasing/Editing] and [Settings] chapters.

## 4 Taking Pictures

This chapter explains the various ways of capturing images and how to set the relevant functions, including how to use the virtual mode dial to change the shooting mode and how to select the Picture mode best suited to the shooting scene.

## 5 Recording and Playback

This chapter explains how to record sound only or add a voice memo to an image, and how to play back voice memos.

## 6 Playback/Erasing/Editing

This chapter explains how to play back images on the camera or on a TV and how to delete images.





## 7 Settings

This chapter explains how to set the camera-related functions.

## 8 Appendix

This tells you about the messages displayed on the LCD monitor and what to do in the event of trouble.

The meanings of the symbols used in this Operating manual are explained below.

	indicates the reference page number for an explanation of the related operation.
	indicates information that is useful to know.
	indicates precautions to be taken when operating the camera.
	The icons above the title show the Capture modes, that can activate the function.

## Checking the Contents of the Package



Camera  
Optio S4

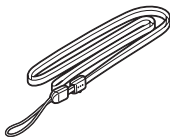

Strap  
O-ST5 (\*)

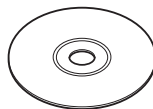

Software (CD-ROM)  
S-SW14

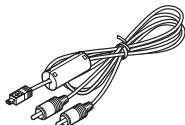

AV cable  
I-AVC7 (\*)

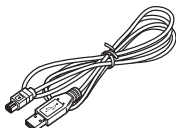

USB cable  
I-USB7 (\*)



3D Image Viewer  
O-3DV1



Rechargeable  
Lithium-ion battery  
D-LI8 (\*)

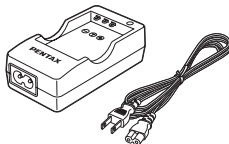

Battery charger  
D-BC8 (\*)



Operating Manual  
this manual

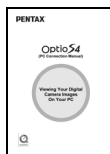

Operating Manual  
(PC Connection Manual)

### About items marked with (\*)

\* Items marked with (\*) are also available as optional accessories. For other optional accessories, refer to the list on page 111.

### \*Type of AC plug cord

D-CO2A Australia / D-CO2B United Kingdom / D-CO2E Europe / D-CO2H Hong Kong / D-CO2J Japan / D-CO2K Korea / D-CO2U North America, Canada

# Names of Parts

## Front

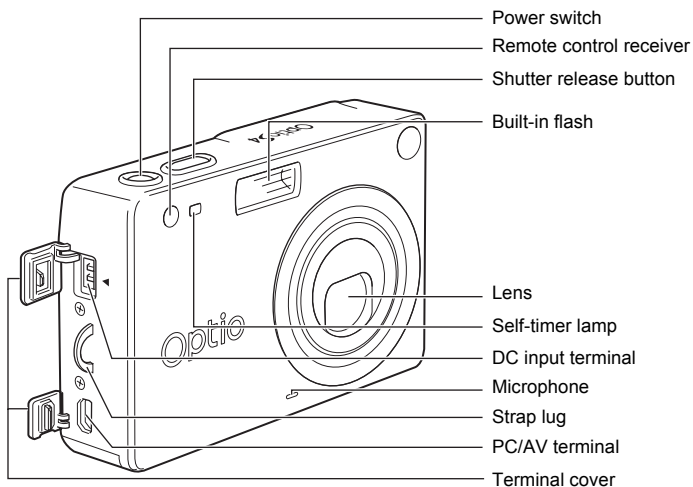

## Back

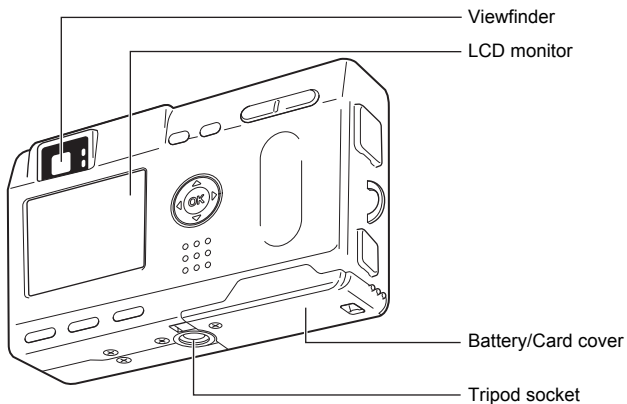

## Names of Operating Parts

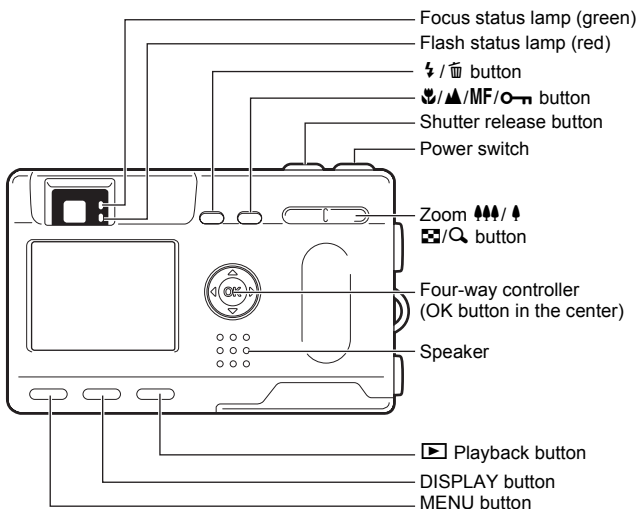

### Guide indications

A guide to available button operation is displayed on the LCD monitor during operation. The buttons are indicated as shown below.

Four-way controller (▲)	▲	Zoom 📺 / 🔍 button (Only for digital zoom and magnified playback)	🔍
Four-way controller (▼)	▼	Display button	DISP
Four-way controller (◀)	◀	🗑️ button	🗑️
Four-way controller (▶)	▶	🔑 button	🔑
MENU button	MENU	OK button	OK

# Attaching the Strap

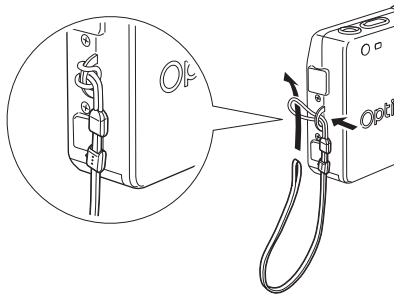

Pass the narrow end of the strap through the strap lug and pass the other end through the loop.

# Powering the Camera

1

Getting Started

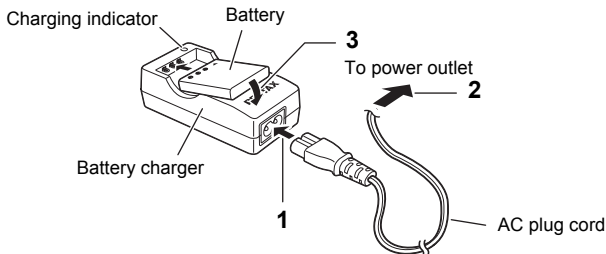

## Charging the Battery

When using the camera for the first time or when the [Battery depleted.] message is displayed, charge the battery.

- 1 Connect the AC plug cord to the battery charger.**
- 2 Plug the AC plug cord into the power outlet.**
- 3 Place the battery in the charger so that the PENTAX name is visible.**

The charging indicator lights red while the battery is charging and changes to green when charging is completed.
- 4 When charging is completed, remove the battery from the battery charger.**



- The time required for full charge is about 100 minutes maximum. The appropriate ambient temperature range for charging the battery is 0°C-40°C (32°F to 104°F).
- The charging time may vary depending on the ambient temperature and charging conditions.
- When the battery reaches the end of its service life, the time that the camera can be operated becomes shorter even when the battery is fully charged. In this event, replace the battery.



- Always charge the battery after purchasing or when it has not been used for a long time.
- Do not use the battery charger D-BC8 to charge the battery other than the rechargeable lithium-ion battery D-LI8, as the charger may overheat or be damaged.
- If the battery is inserted correctly but the charging indicator fails to light, the battery may be faulty. Replace with a new battery.

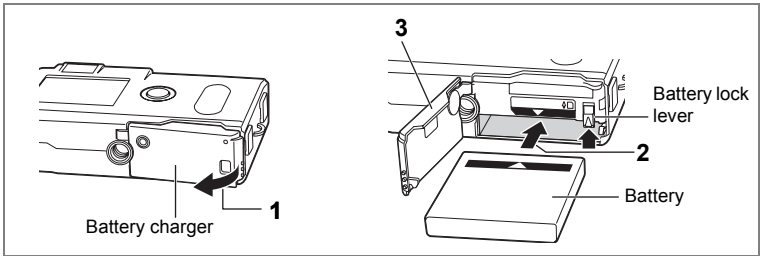

## Installing the Battery

Install the battery provided. When using the camera for the first time, charge the battery before installing.

- 1** Slide the battery/card cover in the direction indicated by the arrow and flip the cover open.
- 2** Insert the battery with ▲ symbol facing toward the LCD monitor while using the side of the battery to press the battery lock lever in the direction indicated by the arrow.
- 3** Close the battery/card cover.

To remove the battery, release the battery by using your finger to press the battery lock lever in the same direction as when you inserted the battery, and pull the battery out.



- If you intend to use the camera continuously for a long period, use of the AC adapter D-AC8 (optional) is recommended. (p.15)



- Do not remove the battery when the camera is turned on.
- If you do not intend to use the camera for a long time, remove the battery.
- If the camera is left without the battery for a long time, the date setting will be reset.
- Insert the battery correctly. If the battery is incorrectly oriented, it may cause malfunction.
- Do not twist the battery/card cover more than is necessary when it is open. Doing so may damage the cover.

## • Approximate Operating Time (when the D-LI8 battery is fully charged)

Number of recordable images : Approx. 180 (when 50% shooting uses flash, LCD monitor ON)

Playback time : Approx. 110 min.

- The description above is based on Pentax measuring conditions and may vary depending on capture mode and shooting conditions.



- Generally, battery performance is temporarily deteriorate as temperature decreases. When the camera is used in a cold environment, keep this product warm by holding it in some protection against cold or inside the clothes. Battery performance once deteriorated due to low temperature will be recovered when the batteries are returned to room temperature.
- Be sure to take a spare battery with you when travelling abroad or to a cold region or if you intend to take a lot of pictures.

## • Battery Level Indicator

You can check the battery level by the  symbol displayed on the LCD monitor.

 (lit green) : Adequate power remains.



 (lit green) : Battery is running low.



 (lit yellow) : Battery is running very low.



 (lit red) : Battery is exhausted.



[Battery Depleted] : After the message is displayed, the camera will turn off.



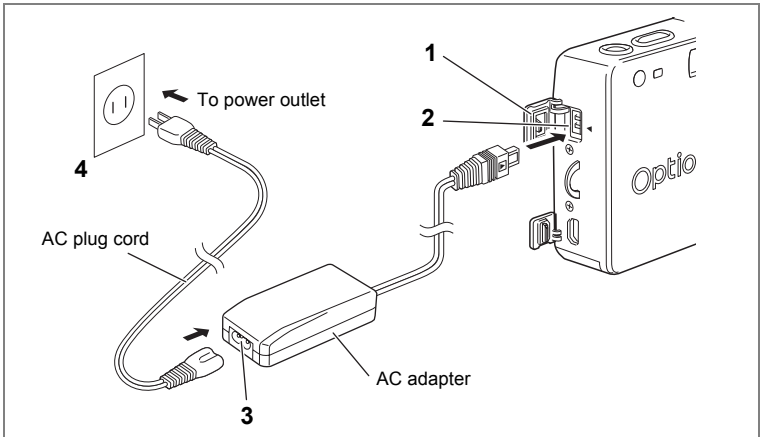

## Using the AC Adapter (optional)

If you intend to use the LCD monitor for a long time or connect the camera to a PC, use of the AC adapter D-AC8 (optional) is recommended.

- 1** Make sure that the camera is turned off and open the terminal cover.
- 2** Connect the DC terminal on the AC adapter to the DC input terminal on the camera, being sure to match the ◀ symbols.
- 3** Connect the AC plug cord to the AC adapter.
- 4** Plug the AC plug cord into the power outlet.



- Make sure that the camera is turned off when connecting or disconnecting the AC adapter.
- Make sure that the AC plug cord and connecting cord are inserted securely. If the cord becomes disconnected while you are taking pictures, the data may be lost.
- When using the AC adapter D-AC8, be sure to read the operation manual accompanying the AC adapter.
- When connecting the DC terminals, be sure to match the ◀ symbols. Inserting the plugs with too much force may damage them.

# Installing the SD Memory Card / MultiMediaCard

1

Getting Started

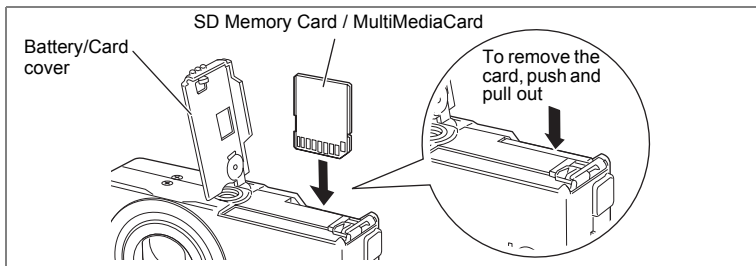

This camera uses an SD Memory Card and MultiMediaCard. Captured images are recorded on the SD Memory Card / MultiMediaCard if a card is inserted (☑ icon on the LCD monitor), or in the Built-in memory if no card is inserted (📷 icon on the LCD monitor). Make sure that the camera is turned off before inserting or removing the SD Memory Card / MultiMediaCard.

- 1 Open the battery/card cover.**
- 2 Insert SD Memory Card / MultiMediaCard so the label (the side with the ▲ symbol) is facing toward the LCD monitor and push the card in until it clicks.**
- 3 Close the battery/card cover.**

To remove the card, eject the card by pressing it in the direction indicated by the arrow and pull it out.

## • Approximate Number of Recordable Images and Recorded pixels/Quality levels

Quality Level	Best	Better	Good	Movie images (320 × 240)
Recorded Pixels	★★★	★★	★	
2304 × 1728	5	9	14	60 sec × 1
1600 × 1200	11	20	28	
1024 × 768	26	47	62	
640 × 480	57	89	119	

- The above table indicates the number of images when using a 16MB SD Memory Card.
- The above table is based on standard shooting conditions specified by PENTAX and may vary depending on the subject, shooting conditions, capture mode, SD Memory Card, etc.

## Data Backup

Very occasionally, data stored in the Built-in memory becomes unreadable. As a backup measure, we recommend that you download important data to a PC or store the data in a media other than the Built-in memory.

## Precautions When Using a SD Memory Card / MultiMediaCard

- Make sure that the camera is turned off before opening the battery/Card cover.
- The SD Memory Card / MultiMediaCard is equipped with a write-protect switch. Setting the switch to [LOCK] protects the existing data by prohibiting recording of new data, deletion of existing data or formatting of the card.

Write-protect switch

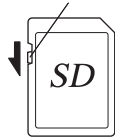

- Care should be taken if you remove the SD Memory Card / MultiMediaCard immediately after using the camera, as the card may be hot.
- Do not remove the SD Memory Card / MultiMediaCard or turn the camera off while data is being recorded on the card or transferred to PC using USB cable as this may cause the data to be lost or the card to be damaged.
- Do not bend the SD Memory Card / MultiMediaCard or subject it to violent impact. Keep it away from water and store away from high temperature.
- Be sure to format unused SD Memory Card / MultiMediaCard or SD Memory Card / MultiMediaCard that have been used on another camera. Refer to "Formatting a SD Memory Card / MultiMediaCard and the Built-in memory" (p.96) for instructions on formatting.
- Never remove the SD Memory Card / MultiMediaCard during formatting as this may cause the card to be damaged and become unusable.
- The data on the SD Memory Card / MultiMediaCard may be erased in the following circumstances. Pentax does not accept any liability for data that is erased
  - when the SD Memory Card / MultiMediaCard is mishandled by the user.
  - when the SD Memory Card / MultiMediaCard is exposed to static electricity or electrical interference.
  - when the card has not been used for a long time.
  - when the card is ejected, the AC adapter is disconnected or the battery is removed while the data on the card is being accessed.
- The SD Memory Card / MultiMediaCard has a limited service life. If it is not used for a long time, the data on the card may become unreadable. Be sure to make a backup of important data on a PC.
- Avoid using or storing the card where it may be exposed to static electricity or electrical interference.
- Avoid using or storing the card in direct sunlight or where it may be exposed to rapid changes in temperature or to condensation.

# Initial Settings

1

Getting Started

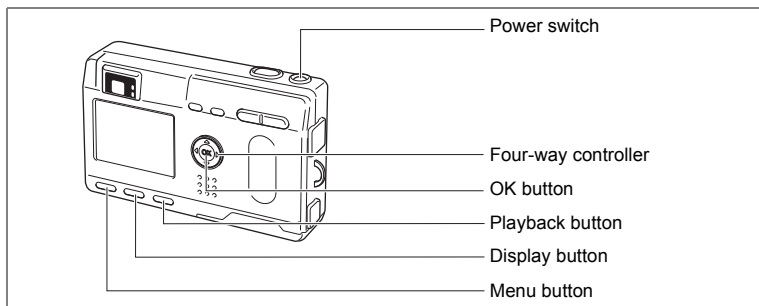

If the initial settings screen appears when you turn the camera on, follow the procedure below to set the display language, Home Town, DST and current date and time. If the date and time that appear at the bottom right of the LCD monitor when you turn the camera on for the first time is not the current time, follow the instructions for “Changing the Date/Time” (p.100) to set the correct date and time.

## Setting the Display Language

You can choose the language in which the menus, error messages, etc. are displayed from the following: English, French, German, Spanish, Italian, Russian, Chinese and Japanese.

- 1 Turn the camera on.**
- 2 Use the four-way controller (◀▶) to select the display language.**
- 3 Press the four-way controller (▼).**

The default setting is English.

The screen for setting the city will be displayed.

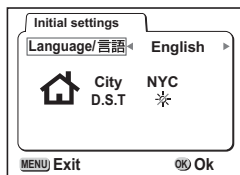

- You can change the setting after it has been made. Refer to “Changing the Display Language” (p.102).

## Setting the Home Town

You can choose the city (Home Town) in which you will use the camera.

**1 Press the four-way controller (◀▶) to select the desired city (Home Town).**

**2 Press the four-way controller (▼).**

The screen for setting the D.S.T will be displayed.

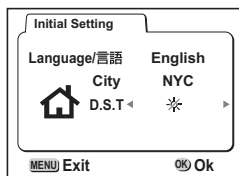

- See p.110 for the list of cities and corresponding code names.
- You can change the setting after it has been made. Refer to “Setting the World Time” (p.100).

## Setting the D.S.T. Mode

You can choose whether or not to display the D.S.T (Daylight Saving Time) mode.

**1 Use the four-way controller (◀▶) to select ※ (On) or ※ (Off).**

The default setting is  (Off).

**2 Press the OK button.**

The screen for setting the Date and Time will be displayed.

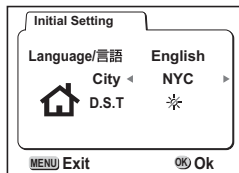

- You can change the setting after it has been made. Refer to “Setting the World Time” (p.100).

# Setting the Date and Time

Set the current date and time.

- 1 Use the four-way controller (▲▼) to change the month.

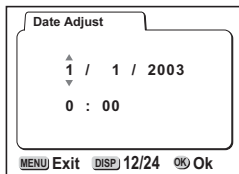

- 2 Press the four-way controller (▶).  
▲ and ▼ will be displayed above and below the day.

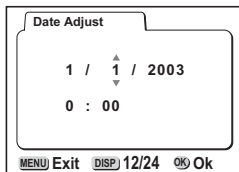

- 3 Use the four-way controller (▲▼) to change the day and press the four-way controller (▶).  
▲ and ▼ will be displayed above and below the year.

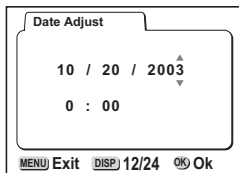

- 4 Repeat Step 3 to change the [year] [hour] and [minutes].

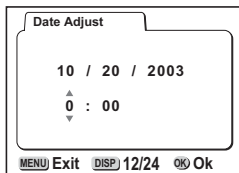

- 5 Use the Display button to select the 12-hour or 24-hour display format.

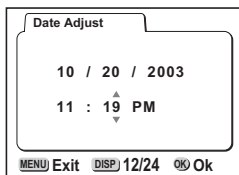

## 6 When you have finished the settings, press the OK button when the clock reaches 00 seconds.

The camera is ready to take a picture.

When you set date and time except the initial settings, press the OK button again after pressing the OK button when the clock reaches 00 seconds to return to capture mode.



- When the initial settings screen is displayed, you can cancel the settings operation and switch to Capture mode by pressing the MENU button. If this is done, the initial settings screen will be displayed next time you turn the camera on.
- You can change the settings after they have been made. Refer to "Changing the Date/Time" (p.100).

## Taking Still Pictures

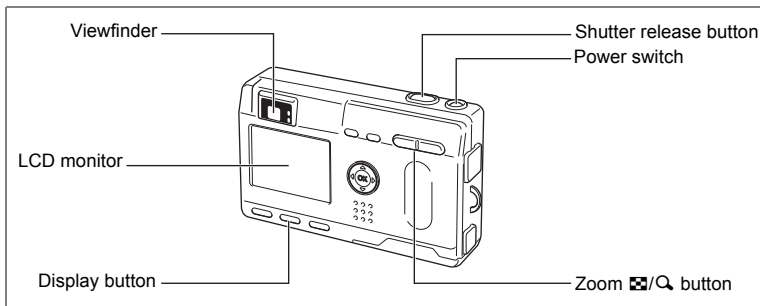

For the simplest procedure to take still pictures:  
The flash fires automatically depending on the light conditions.

### 1 Press the power switch.

The camera will turn on.

### 2 Confirm the subject and shooting information on the LCD monitor.

The focus frame in the middle of the LCD monitor indicates the zone of automatic focusing. You can change the size of the subject by pressing the Zoom button.

▲ : makes the subject bigger.

◆◆◆ : makes the subject smaller.

You can check the size of the subject by looking through the viewfinder.



Focus frame



As there is no focus frame in the viewfinder, be sure to check the focusing area on the LCD monitor.



### 3 Press the shutter release button.

The image will be displayed on the LCD monitor for 1 second (Instant Review) and recorded on the SD Memory Card / MultiMediaCard or the Built-in memory. (The green and red lamps on the right of the viewfinder blink alternately while the image is being recorded on the SD Memory Card / MultiMediaCard or the Built-in memory.)

#### Using the Shutter Release Button

The shutter release button works in a two-step action.

##### • Press halfway

When the shutter release button is pressed lightly (halfway), the focus, exposure and white balance are locked.

The shutter speed and aperture settings are only displayed when the shutter release button is pressed lightly (halfway).

You can find the following information on the LCD monitor, the status lamp and the flash lamp.

##### 1. Autofocus frame

If the subject is in focus, the frame will light green. If the subject is out of focus, the frame will not be displayed.

##### 2. Focus status lamp & Flash status lamp

status	Focus status lamp (green)	Flash status lamp (red)
Lit	Subject is in focus	Flash is charged
Blink	Subject is out of focus	Flash is charging

You cannot take a picture while the flash is charging.

##### • Press down fully

The picture is taken.

#### Instant Review

The Instant Review default setting is 1 second. During this time you can delete the image by pressing the  button (The [Delete] menu will be displayed.), and selecting [Delete], and then pressing the OK button. You can also record a voice memo by pressing the OK button during Instant Review (see p.78).

Setting the Instant Review Time see p.48

## Playing Back Still Pictures

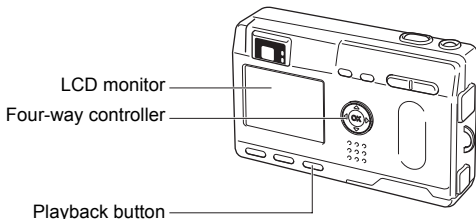

### Playing Back Images

You can display the still picture.

- 1 Press the Playback button after taking a picture.**

The image taken will be displayed on the LCD monitor.

### Playing Back Previous or Next Images

Still images can be played back one at a time, proceeding either forward or backward.

- 1 Press the Playback button after taking a picture.**

An image will be displayed on the LCD monitor.

- 2 Press the four-way controller (◀▶).**



displays the previous image.





displays the next image.

### Rotating a Displayed Image

- 1 Press the four-way controller (▼). The image will rotate clockwise 90°, 180° and 270°.**

Press the OK button to return to normal playback.

## Deleting a Displayed Image

During this time you can erase the image by pressing the  button (The Delete screen will be displayed.), press the four-way controller () to select [Delete], and then pressing the OK button.

Press the Playback button again or press the shutter release button halfway to return to capture mode.

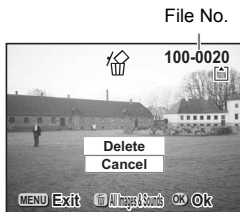

- When the screen is changed to the playback screen, the image with the largest file number will be displayed first
- You can enlarge the image displayed on the LCD monitor by pressing the Zoom  button.
- In the case of movie pictures, the first frame will be displayed.
- If there are no images stored, the [No image&sound] message will be displayed.

Zoom Display  p.79

The zoom display and nine-image display functions cannot be used with rotated images. Moreover, DPOF and delete/protect settings cannot be made. (The camera returns to normal playback.)

## How to View the Recorded Images

Instead of using the Built-in memory, images taken with this camera can be recorded on the SD Memory Card / MultiMediaCard. You can view the images recorded on the card on the camera itself, transfer them to your PC and print them out.



### Viewing Images on the Camera

One of the advantages of a digital camera is that it enables you to view your pictures immediately after you have taken them. You can check the composition and brightness and take the picture again if you are not satisfied.

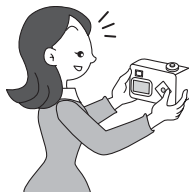

Playing Back Still Pictures  p.79

### Viewing Images on a TV

If you want to show your pictures to friends, you can display them on your TV monitor. To view images on your TV, connect the camera to the TV with the video cable.

Viewing Images on a TV  p.88



## Viewing Images on a PC

Once you have installed the USB driver on your PC, you can view recorded images and edit them on your PC just by connecting the camera to the PC with the USB cable and downloading the images. Or you can remove the SD Memory Card / MultiMediaCard from the camera and transfer the data to your PC using a card reader. If you use a laptop computer, you can transfer the image data by fitting the SD Memory Card / MultiMediaCard into the card adapter and inserting the card adapter into the card slot. (To remove the SD Memory Card / MultiMediaCard from the camera and transfer images using another device, refer to the operating manual for the device.)

☞ Booklet: Viewing Images with your PC  
Viewing Images with your Macintosh



## Printing images by a printing service

Prints of images recorded on the SD Memory Card / MultiMediaCard can be ordered in the same way as with conventional photographs by taking the SD Memory Card / MultiMediaCard to a store that performs printing. The number of prints can be specified and dates can be included in the prints if DPOF (Digital Print Order Format) is set before taking the SD Memory Card / MultiMediaCard to a store that performs DPOF printing.

Setting the Printing Service ☞ p.89



## Turning the Camera On and Off

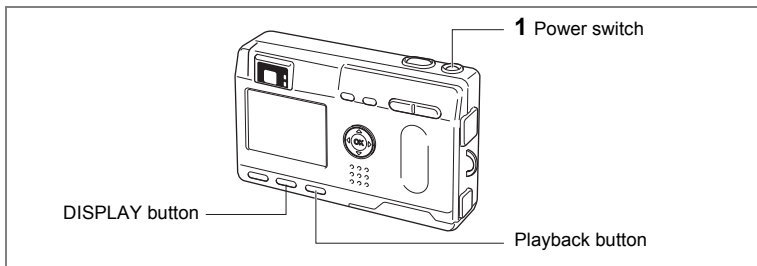

3

## 1 Press the power switch. (The power switch is illuminated by a green light.)

The lens extends when the camera is turned on.

Press the power switch again to turn the camera off.

## Playback Only Mode

Press the power switch while pressing the Playback button to activate the Playback Only mode.

- When the camera is turned on in Playback Only mode, the lens does not extend.
- To switch from Playback Only mode to Capture mode, press the power switch and then press it again.

Playing Back Still Pictures p.79

## Voice Recorder Mode

There are two ways to activate the Voice Recording only mode.  
(The power switch is illuminated by a red light)

- 1 Press the power switch for 2 or more seconds. The lens extends once and retracts.
  - 1 Press the power switch while pressing the DISPLAY button. The lens does not extend.
- To switch from Voice Recording Only mode to Capture Only mode or Playback Only mode, press the power switch and then press it again.

Recording Sound Only p.76

# Using the Button Functions

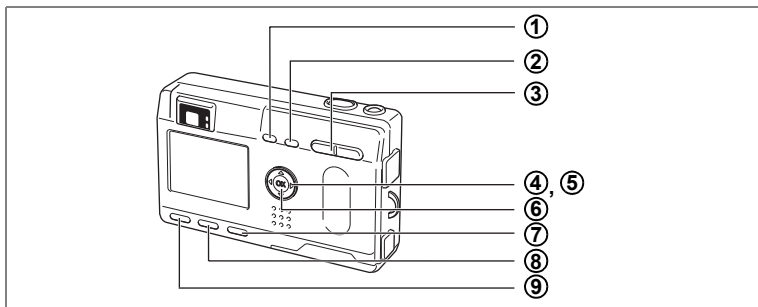

## Capture Mode

- ① **Flash button**  
Changes the flash mode. (☞ p.39)
- ② **MF/AF-L button**  
Changes the focus mode as follows. (☞ p.37)  
Macro mode (☞ p.37) Super macro mode (☞ p.37)  
Infinity-landscape mode (☞ p.37) Manual focus mode (☞ p.38)  
Move focusing area (☞ p.38)
- ③ **Zoom button**  
Changes the size of the subject. (☞ p.22)
- ④ **Four-way controller (◀▶)**  
Changes the EV compensation in all modes. (☞ p.52)  
The function registered on the four-way controller can be changed in the Fn settings. (☞ p.106)  
Adjusts the ratio when the digital filter is set to Slim Filter on the virtual mode dial. (☞ p.60)
- ⑤ **Four-way controller (▲▼)**  
(▲) Selects self-timer mode, remote control mode and continuous shooting mode.  
(▼) Displays the virtual mode dial and changes the shooting mode  
Adjusts the focus in MF mode. (☞ p.38)
- ⑥ **OK button**  
Determines the Menu items. (☞ p.32)
- ⑦ **Playback button**  
Switches to Playback mode. (☞ p.24)
- ⑧ **DISPLAY button**  
Changes the information displayed on the LCD monitor. (☞ p.40, 81)
- ⑨ **MENU button**  
Displays the active menus in [Rec. Mode], [Playback] and [Set-up]. (☞ p.32)

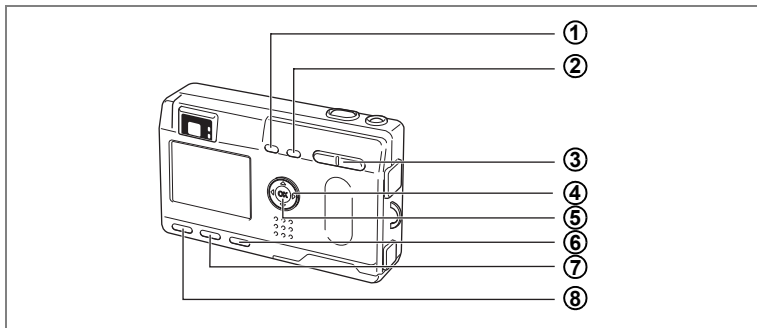

## Playback Mode

- ① **🗑️ button**  
Deletes the image. (☞ p.84)
- ② **🔒 button**  
Protects the image from erasure. (☞ p.87)
- ③ **Zoom/📷/🔍 button**  
📷 displays nine images at once. (☞ p.82)  
-🔍+ changes the size of the Zoom Display image, displayed on the LCD monitor. (☞ p.79)
- ④ **Four-way controller (⬅️➡️)**  
(⬆️) Sets the DPOF (☞ p.89) for the print service.  
(⬅️➡️) Displays the image you wish to view. (☞ p.25)  
(⬇️) Rotate the image.
- ⑤ **OK button**  
Determines the Menu items. (☞ p.32)  
Playback Voice memo.
- ⑥ **Playback button**  
Switches to Playback mode. (☞ p.24)
- ⑦ **Display button**  
Changes the information displayed on the LCD monitor. (☞ p.40, 81)
- ⑧ **MENU button**  
Displays the active menus in [Playback] and [Set-up]. (☞ p.32)



When the camera is turned on in Playback Only mode, pressing the Playback button does not change the mode to the Capture mode. Turn the camera off and turn it on again to switch from playback only mode to capture mode.



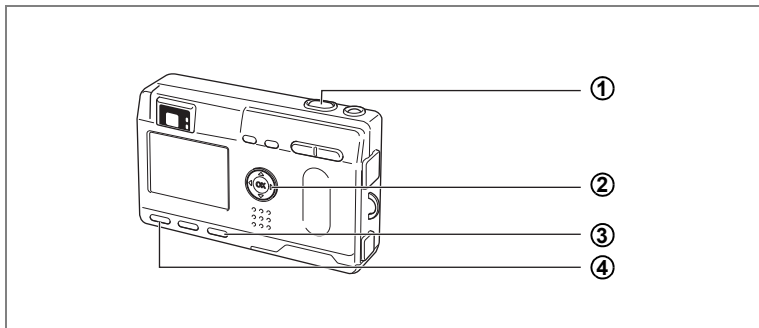

## Voice Recorder Mode

### ① Shutter release button

When pressed, starts recording, and when pressed again, stops recording.

### ② Four-way controller

(▲) Starts playback. When pressed during playback, pauses playback.

(◀▶) Selects a recorded file before playback.

If there are no recorded indexes:

When (◀) is pressed during playback, rewinds 5 seconds.

When (▶) is pressed during playback, advances 5 seconds.

If there are recorded indexes:

When (◀) is pressed during playback, plays back starting from the previous index.

When (▶) is pressed during playback, plays back starting from the next index.

### ③ Playback button

Switches between Voice Recorder Mode and Playback mode.

### ④ MENU button

When pressed during recording, an index can be added.)



When the shutter release button is pressed for more than 1 second, recording continues for as long as the button is held down and stops when the button is released.

# Setting the Menus

When you press the MENU button, the menus are displayed on the LCD monitor. You can set functions, save the settings, and change the camera settings on these menus.

## How to Set the Menus

When you are making settings from a menu, a guide to operation is displayed on the LCD monitor.

### 1 Press the MENU button.

The menu screen will be displayed. The selected area will be displayed in a green frame.

### 2 Press the four-way controller (◀▶).

Use the four-way controller (◀▶) to select the menu screen.

### 3 Use the four-way controller (▲▼) to select an item.

Use the four-way controller (▲▼) to move the frame up or down.

### 4 Use the four-way controller (◀▶) to change the setting.

### 4' If there is a Select screen, use the four-way controller (▶) to move to the Select screen.

When you have finished making the settings, press the OK button to return to the menu.

### 5 Press the OK button.

The settings will be saved and the screen will return to capture or playback status.



- If you press any buttons except the OK button before press the OK button and leave the menu screen, any changes to setting will not be saved.
- Even after you press the OK button and leave the menu screen, if you turn the camera off incorrectly (such as removing the battery when the camera is on), any changes to the setting will not be saved.

## Example of menu operation

### 1 MENU button

#### [Rec. Mode] Menu

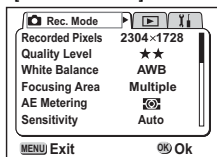

### 2

#### [Playback] Menu

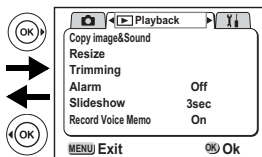

#### [Setup] Menu

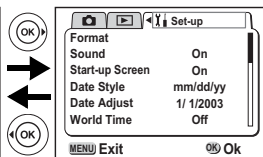

### 3

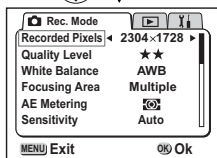

### 3



### 4

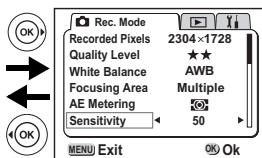
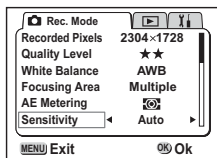

### 3



### 4'

#### Select Screen

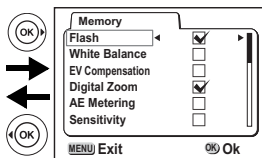
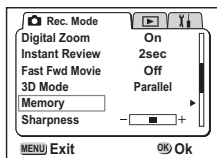

### 3



To the next screen











- If you press the shutter release button halfway to leave the menu screen and switch to Capture mode, any changes to the setting will not be saved.
- When you display the menu from Capture mode, the [Rec. Mode] menu will be displayed, and when you display the menu from Playback mode, the [Playback] menu will be displayed.

## Menu List

### • [📷 Rec. Mode] Menu

○...Adjustable

✕...Any changes made are invalid.

Item	Description	Default Setting	 Panorama  Picture Mode  3D  USER  		Reference
Recorded Pixels	For selecting the size of recorded pixels	2304×1728	○	○	p.41
Quality Level	For selecting the image compression rate.	★★	○	✕	p.42
White Balance	For adjusting the color balance according to lighting.	AWB (Auto)	○	○	p.43
Focusing Area	For changing the Area of the autofocus.	[  ] (Multiple)	○	✕	p.45
AE Metering	For setting the metering method to determine the exposure.		○	○	p.46
Sensitivity	For setting the Sensitivity.	Auto	○	✕	p.47
Digital Zoom	For taking digital zoom pictures.	On	○	○	p.71
Instant Review	For setting the instant review time.	1 sec	○	✕	p.48
Fast Fwd Movie	For setting the startup, shutter and button operation sounds.	Off	✕	○	p.73
3D Mode	For taking 3D pictures.	Parallel mode	○ (3D only)	✕	p.63
Memory	For saving the shooting function settings when the camera is turned off.	Normal	○	○	p.74
Sharpness	For setting the sharpness.	Normal	○	✕	p.49
Saturation	For setting the saturation.	Normal	○	✕	p.50
Contrast	For setting the contrast.	Normal	○	✕	p.51
EV Compensation	For adjusting the exposure between -2.0 and +2.0.	±0.0	○	○	p.52



For “✕” items, you can change the setting on the menu screen, however, any changes are invalid in actual operation.

## • [▶] Playback] Menu

Item	Description	Reference
Copy image & Sound	For copying files between the Built-in memory and the SD Memory Card / MultiMediaCard.	p.95
Resize	Changes the size of images	p.92
Trimming	For trimming images	p.94
Alarm	For setting the alarm to ring at a specific time	p.108
Slide Show	Recorded images are played successively.	p.83
Record Voice Memo	For setting the voice memo recording in the playback mode.	p.78

## • [ⓘ] Set-up] Menu

Item	Description	Reference
Format	For formatting the SD Memory Card / MultiMediaCard	p.96
Sound	For setting the volume of the playback sound, operation sounds (start-up sound, shutter sound, key operation sound, focus sound, self-timer sound) and type of operation sounds.	p.97
Start-up Screen	For setting the Start-up screen when the camera is turned on.	p.98
Date Style	For setting the date style	p.99
Date Adjust	For adjusting the date and time	p.100
World Time	For setting the world time	p.100
Language/ 言語	For changing the language in which menus and messages are displayed	p.102
Video Out	For setting the video output format	p.103
Sleep Timeout	For setting the power saving function	p.104
Auto Power Off	For turning off the power automatically	p.104
Quick Delete	When this option is turned on, the Delete screen is displayed with [Delete] or [All Images] selected.	p.105
Quick Zoom	For playing back images at the maximum zoom size with the Zoom button pressed only once	p.105
Fn Setting	For registering a function on the four-way controller (◀▶)	p.106
Reset	For returning the camera settings to defaults	p.107

## Changing the Mode

Capture mode is for taking pictures and Playback mode is for playing back or erasing images.







### Switching between Capture Mode and Playback Mode

- To change from Capture mode to Playback mode, press the Playback button.
- To change from Playback mode to Capture mode, press the Playback button or the shutter release button halfway.

4

### Selecting the Capture Mode

Display the virtual mode dial and select the shooting mode. There are 8 modes to choose from.

	Program mode	Lets you set all the functions.	p.22
 (Default setting)	Picture mode	Lets you set the functions according to the situation. There are 7 available modes in Picture mode.	p.54
	Night-Scene mode	Lets you take dark scenes such as night views.	p.55
	Movie Picture mode	Lets you take movies.	p.56
	Panorama Assist mode	Lets you take panorama pictures.	p.58
	3D Image mode	Lets you take 3D pictures.	p.63
	Digital Filter mode	Lets you set a color filter.	p.60
USER	USER mode	Lets you activate the preset function settings simply by turning the camera on.	p.62

### 1 Press the four-way controller (▼) in Capture mode.

The virtual mode dial appears.

### 2 Move the icon for the desired mode to the top of the dial using the four-way controller (◀▶).

The icon will be surrounded by a green frame.

### 3 Press the OK button.

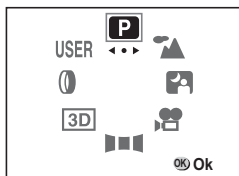

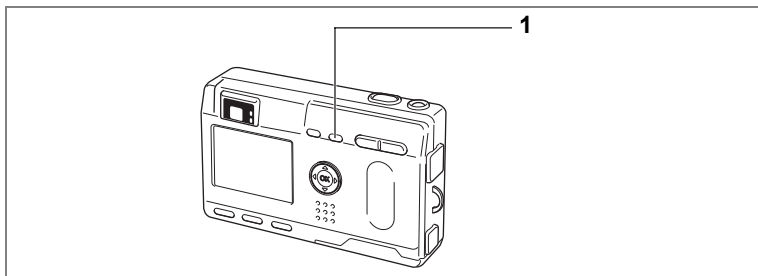

## Selecting the Focus Mode

### • Focus Mode

(No icon)	Autofocus mode	The camera is focused on the subject in the autofocus area when the shutter release button is pressed halfway. Use this mode when the distance to the subject is more than 40 cm (1.3 ft).
🌸	Macro mode	This mode is used when the distance to the subject is approx. 18 cm –50 cm (7 inch –20 inch). When the shutter release button is pressed halfway, the camera is focused on the object in the autofocus area.
🌸	Super macro mode	This mode is used when the distance to the subject is approximately 6 cm –20 cm. (2.4 inch –8 inch). The camera is focused on the subject in the autofocus area continuously pressing with the shutter release button halfway.
▲	Infinity-landscape mode	This mode is used for taking distant objects.
MF	Manual focus mode	Adjust focus manually by the four-way controller (▲▼).
📍	Focusing area mode	The position of the autofocus area is changed.

### 1 Press the 🌸 ▲ or MF button in Capture mode.

The focus mode changes each time the button is pressed and the setting is displayed on the LCD monitor.

The camera is ready to take the picture in the set focus mode.



- The default setting of the focus mode is [Autofocus mode].
- The zoom position is fixed at the middle and the flash will not discharge in [Super Macro Mode].
- When the movie picture mode (📽 p.56) is selected, the focus mode is set to Autofocus mode, Infinity-landscape mode and Manual focus mode.
- The flash does not fire in Super Macro mode.

**Caution**

If you take a picture while looking through the viewfinder when the focus mode is set on Macro and Super Macro, the range of the resulting picture will differ from what was seen in the viewfinder. Be sure to check the image on the LCD monitor.

## Manual Focus

When the mode is set to MF, the central portion of the picture is enlarged to full screen on the LCD monitor for focus adjustment. Use the four-way controller to adjust the focus while watching the indicator on the monitor.



For distant focus



For closer focus

After the focus is set, press any buttons except the four-way controller (▲▼) or take a finger off from the four-way controller (▲▼). The screen returns to the normal display two seconds later.





The central portion of the picture is not enlarged when the digital zoom is enabled.

Saving the Focus Mode  p.74

## Changing the Focusing Point

In autofocus mode, you can change the focusing point by moving the autofocus area.

- 1 In Focusing area mode, press the four-way controller (▲▼◀▶) to move the autofocus area ([ ]).**
- 2 Press the shutter release button.**

To return the autofocus area to its original location, press the   MF button again.



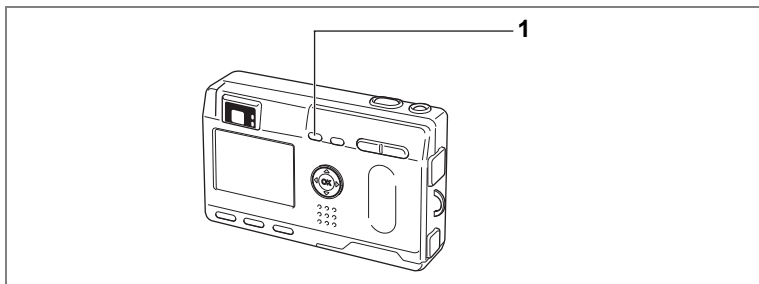

## Selecting the Flash Mode

(No icon)	Auto flash	The flash discharges automatically depending on the light conditions.
	Flash Off	The flash will not discharge, regardless of the brightness.
	Flash On	The flash discharges regardless of the brightness.
	Auto flash + Red-eye reduction	This mode reduces the phenomenon of red eyes caused by the light from the flash being reflected in the subject's eyes. The flash discharges automatically.
	Flash On + Red-eye reduction	This mode reduces the phenomenon of red eyes caused by the light from the flash being reflected in the subject's eyes. The flash will discharge regardless of lighting conditions.



- The flash is off when the Capture mode is set to , continuous shooting or infinity-landscape.
- The flash discharges a total of 3 times, 2 pre-flashes and the third time to take the picture. (In the red-eye reduction modes, the interval between the pre-flashes and the main flash is longer.)

### 1 Press the button in Capture mode.

The flash mode changes each time the button is pressed and the icon is displayed on the LCD monitor.

The camera is ready to take the picture in the set flash mode.

Status of the Focus Status Lamp and Flash Status Lamp p.23  
 Saving the Flash Mode p.74



Using the flash in Macro mode may cause the image to be overexposed.

## Displaying Shooting Information in Capture Mode

You can display information on the LCD monitor when shooting. The display mode can be changed by pressing the Display button.

### Display On

Shooting information is displayed.

- |                               |                        |
|-------------------------------|------------------------|
| 1 Flash mode                  | 2 Shooting mode        |
| 3 Focus mode                  | 4 Capture mode         |
| 5 AF frame                    | 6 Card/Built-in memory |
| 7 Number of recordable images |                        |
| 8 Date & time                 | 9 Battery indicator    |

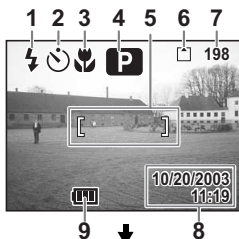

4

### Histogram Display

The brightness distribution of the image is displayed.

The x-axis shows the brightness (darkest at the left end and brightest at the right end) and the y-axis shows the pixel numbers.

- |                 |                   |
|-----------------|-------------------|
| 1 Histogram     | 2 Recorded pixels |
| 3 Quality level | 4 White balance   |
| 5 AE metering   | 6 Sensitivity     |

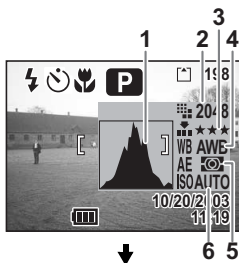

### Display Off

No shooting information is displayed.





- The AF frame is displayed in Autofocus mode.
- If any of the modes are changed such as Flash mode, the mode you have changed is displayed for a few seconds.

### LCD Monitor Off

Turn off the LCD monitor.

(The LCD monitor is not turned off in Playback mode.)



The display cannot be turned off in , , , and  mode.

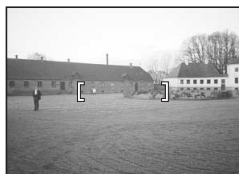

Display On

Saving the Display Mode  p.74

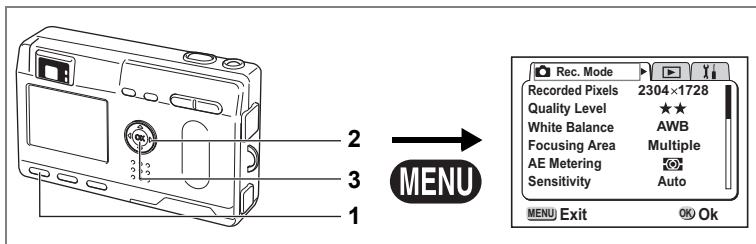

**P** Picture Mode USER

## Selecting the Recorded Pixels

You can choose the number of recorded pixels from [2304×1728], [1600×1200], [1024×768] and [640×480].

2304×1728	Suited for printing on A4 paper (8 1/2 × 11)
1600×1200	Suited for printing on A5 paper
1024×768	Suited for printing on postcards
640×480	Suited for attaching to E-mails or for creating websites

- 1 Select [Recorded Pixels] on the [Rec. Mode] menu.**
- 2 Use the four-way controller (◀▶) to change the size.**
- 3 Press the OK button.**

The camera is ready to take the picture.

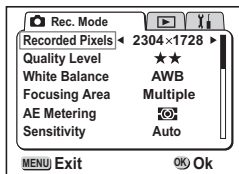

- The recorded pixels is fixed at 320×240 pixels in the movie picture mode.
- If you select a large size, the picture may appear distinct when it is printed out.

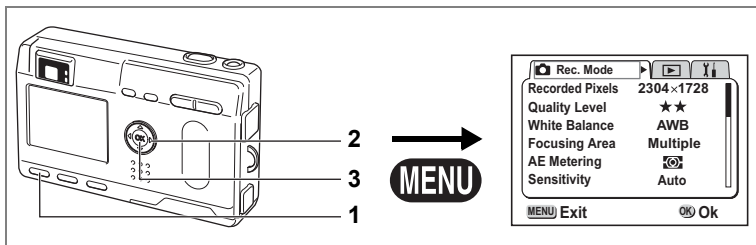

**P** Picture Mode USER

## Selecting the Quality Levels

You can choose the image compression rate. The more stars, the clearer the quality and the larger the volume.

The recorded pixels setting also changes the picture volume.

★★★	Best	Lowest compression ratio. Suited for photo prints.
★★	Better	Standard compression ratio. Suited for viewing the image on a computer screen.
★	Good	Highest compression ratio. Suited for attaching to emails or creating webpages.

**1** Select [Quality Level] on the [ Rec. Mode] menu.

**2** Use the four-way controller ( ) to select the size.

**3** Press the OK button.

The camera is ready to take the picture.

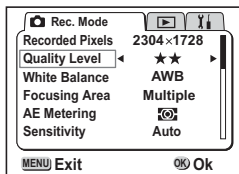

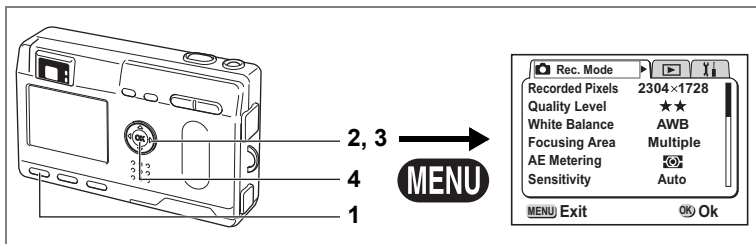

**P** Picture Mode USER

## Adjusting the Color Balance according to Lighting (White Balance)

You can take pictures in natural colors by adjusting the white balance according to the light conditions at the time of shooting.

<b>AWB</b>	Auto	The camera adjusts the white balance automatically.
	Daylight	Use this mode when taking pictures outside in sunlight.
	Shade	Use this mode when taking pictures outside in the shade.
	Tungsten Light	Use this mode when taking pictures under electric or other tungsten light.
	Fluorescent Light	Use this mode when taking pictures under fluorescent light.
	Manual	Use this mode when taking pictures by adjusting the white balance manually.

- 1 Select [White Balance] on the [Rec. Mode] menu.**
- 2 Press the four-way controller (▶).**  
The white balance screen will be displayed.
- 3 Use the four-way controller (◀▶) to select the setting.**
- 4 Press the OK button twice.**  
The camera is ready to take the picture.

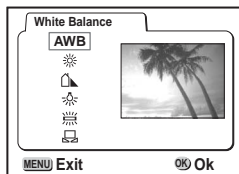

Saving the White Balance p.74

## Manual Setting

- 1 Select [Manual] (manual) on the [White Balance] screen.**
- 2 Point your camera at a blank sheet of paper so that it fills the screen.**
- 3 Press the Display button.**

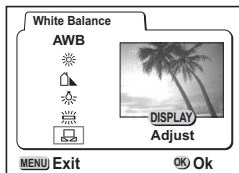

The white balance is automatically adjusted, [Adjust] is displayed on the LCD monitor and the display returns to the menu screen.

- 4 Press the OK button.**

The camera is ready to take the picture.

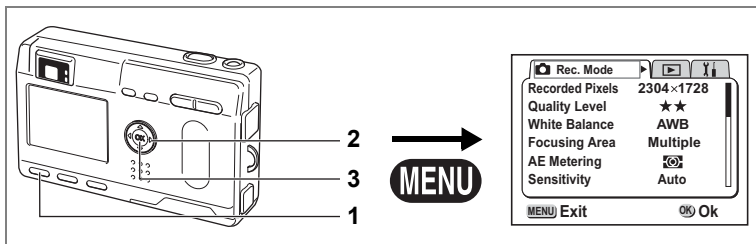

**P** Picture Mode

## Changing the AF Area (Focusing Area)

You can change the autofocus area..

Multiple	Normal range
Spot	The autofocus range becomes smaller. (Spot)

- 1** Select [**Focusing Area**] on the [**Rec. Mode**] menu.
- 2** Use the four-way controller (◀▶) to change the setting.
- 3** Press the OK button.

The camera is ready to take the picture.

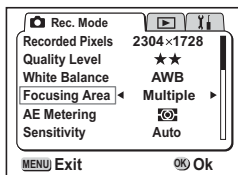

The AF area does not appear in the viewfinder. Always check the focusing area on the LCD monitor.

Saving the Focusing Area Setting p.74

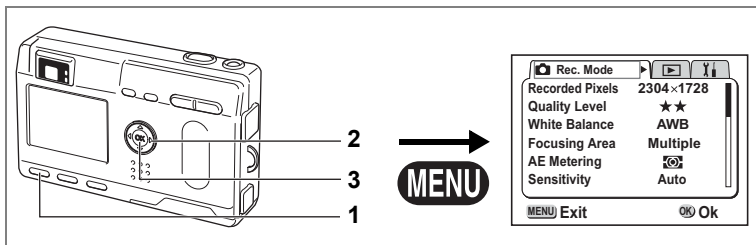

**P** Picture Mode USER

## Setting the Light Metering Range to Determine the Exposure (AE Metering)

4 You can choose which part of the screen to use to measure the brightness and determine the exposure.

	Multi-segment	The exposure is determined by the entire screen.
	Center-weighted	The exposure is determined mainly by the center of the screen.
	Spot	The exposure is determined by the small area in the center of the screen only.

**1** Select [AE Metering] on the [Rec. Mode] menu.

**2** Use the four-way controller (◀▶) to change the metering mode.

**3** Press the OK button.

The camera is ready to take the picture.

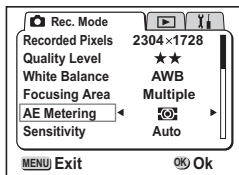

When is selected, the metering point moves in correspondence with movement of the focusing area.

Saving the AE Metering Method p.74



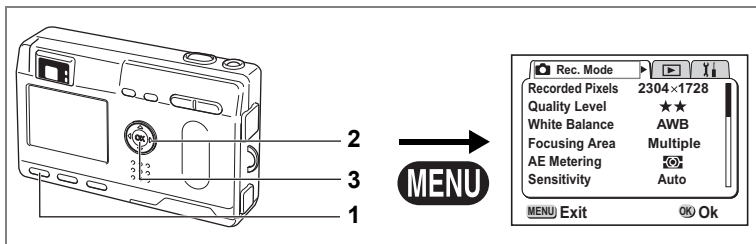

**P** Picture Mode **USER**

## Setting the Sensitivity

You can select the sensitivity to suit the brightness of the surroundings.

### • Sensitivity

AUTO	The camera sets the sensitivity automatically.
50	<ul style="list-style-type: none"> <li>The lower the sensitivity, the sharper the image and the less noise. The shutter speed will be slower in low light conditions.</li> <li>The higher the sensitivity, the faster the shutter speed in low light conditions to reduce camera shake, but the image may be affected by noise.</li> </ul>
100	
200	

- 1 Select [Sensitivity] on the [Rec. Mode] menu.**
- 2 Use the four-way controller (◀▶) to select the sensitivity.**
- 3 Press the OK button.**

The camera is ready to take the picture.

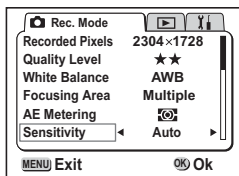

Saving the Sensitivity p.74

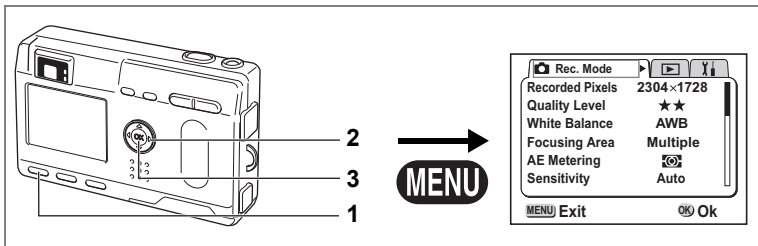

**P** Picture Mode **3D** **USER**

## Setting the Instant Review time (Instant Review)

You can choose the Instant Review time from 0.5sec., 1sec., 2sec., 3sec., 4sec., 5sec. or off (no display).

4

Taking Pictures

- 1** Select [Instant Review] on the [**Rec. Mode**] menu.
- 2** Use the four-way controller (◀▶) to select the display time.
- 3** Press the OK button.

The camera is ready to take the picture.

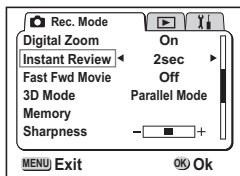

The Instant Review setting is saved when the camera is turned off.

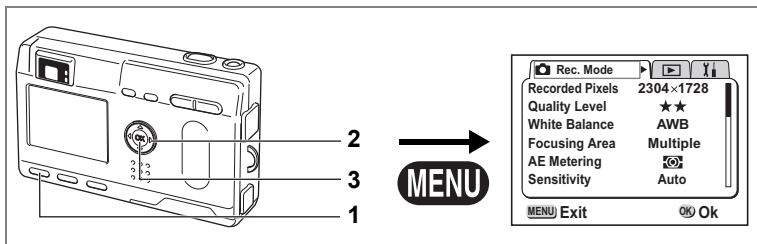

**P** Picture Mode USER

## Setting the Image Sharpness (Sharpness)

You can choose whether you want the image to have sharp or soft outlines.

- 1** Select [Sharpness] on the [ Rec. Mode] menu.
- 2** Use the four-way controller (◀▶) to change the setting from [Normal] to [Hard (+)] or [Soft (-)].
- 3** Press the OK button.

The camera is ready to take a picture.

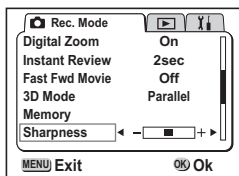

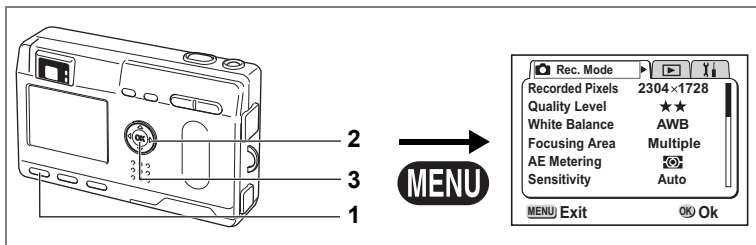

**P** Picture Mode USER

## Setting the Color Saturation (Saturation)

You can set the color saturation.

- 1** Select [Saturation] on the [ Rec. Mode] menu.
- 2** Use the four-way controller ( ) to change the setting from [Normal] to [Hard (+)] or [Soft (-)].
- 3** Press the OK button.

The camera is ready to take the picture.

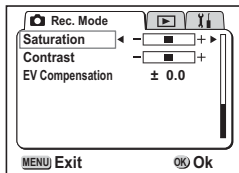

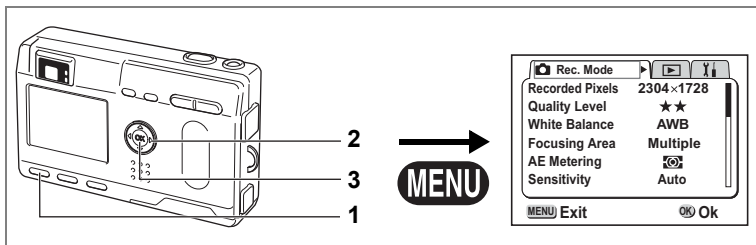

**P** Picture Mode USER

## Setting the Image Contrast (Contrast)

You can set the image contrast.

- 1** Select **[Contrast]** on the **[ Rec. Mode]** menu.
- 2** Use the four-way controller (**◀▶**) to change the setting from **[Normal]** to **[Hard (+)]** or **[Soft (-)]**.
- 3** Press the **OK** button.

The camera is ready to take the picture.

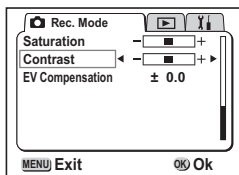

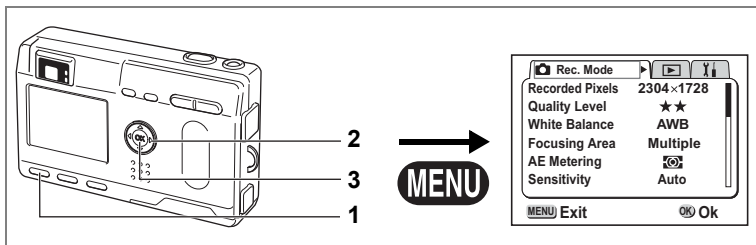

**P** Picture Mode USER

## EV Compensation

You can take pictures that are intentionally over-exposed or under-exposed.

- 1 Select [EV Compensation] on the [📷 Rec. Mode] menu.**
- 2 Use the four-way controller (◀▶) to select the EV setting in the range of  $-2.0$  EV to  $+2.0$  EV in  $1/3$  EV steps.**

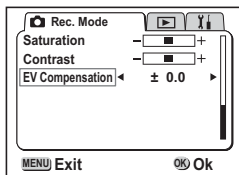

- 3 Press the OK button.**

The camera is ready to take the picture.



EV Compensation is registered on the four-way controller (◀▶) in the Fn default settings. p.106



The light metering method is either center-weighted or spot when the EV setting is adjusted.

Saving the EV Compensation Value p.74

# Taking Pictures

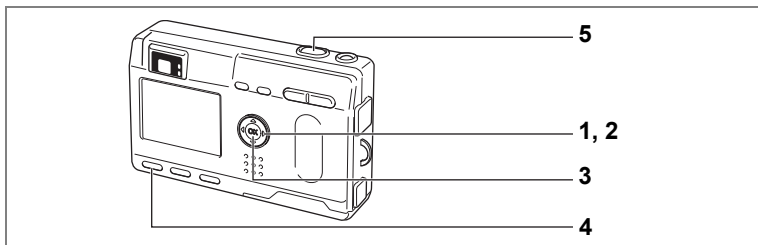

## Setting the Functions (Program Mode)

In Program mode (P), the camera automatically sets the shutter speed and aperture for taking still pictures. However, you can select other functions such as the flash mode or continuous shooting mode.

### 1 Press the four-way controller (▼) in Capture Mode.

The virtual mode dial appears.

### 2 Use the four-way controller (◀▶) to display the Program mode (P) at the top of the dial.

### 3 Press the OK button.

### 4 Set the functions you want to use.

Refer to “Setting the Shooting Functions” (p.36 to p.52) for details of how to set the functions.

### 5 Press the shutter release button.

The picture is taken.

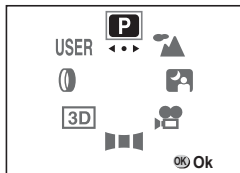

Taking Still Pictures p.22

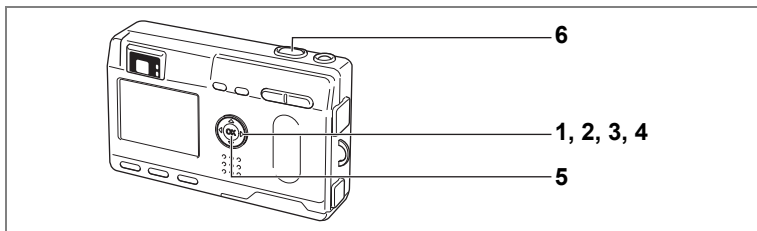

## Selecting the Picture Mode According to the Shooting Scene (Picture mode)

You can select the Picture mode according to the shooting scene.

### • Picture Mode

There are nine available modes in Picture mode.

	Landscape	Enables to take landscape photos with bright colors.
	Flower	Enables to take flower photos bright in color.
	Portrait	Enables to take portraits with spatial effect, by emphasizing the person.
	Self-Portrait	Enables you to take pictures of yourself or to be included in pictures.
	Surf & Snow	Enables to take clear photos at dazzling places like beaches and snow covered mountains.
	Autumn Colors	Enables you to take colorful photos of trees in autumn.
	Sunset	Enables to reproduce beautiful colors for sunrise and sunset photos.

### 1 Press the four-way controller (▼) in Capture Mode.

The virtual mode dial appears.

### 2 Use the four-way controller (◀▶) to display the Picture mode (📷) at the top of the dial.

The default setting is (📷).

The Picture mode dial appears.

### 3 Press the four-way controller (▼) to select the desired mode.

### 4 Use the four-way controller (◀▶) to select the icon for the desired picture mode at the top of the dial.

### 5 Press the OK button.

The Picture mode is selected.

### 6 Press the shutter release button.

The picture is taken.

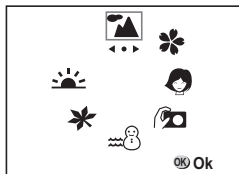
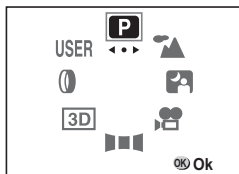

In Picture mode, the EV compensation, saturation, contrast, sharpness and white balance are automatically set to their default settings. You can change the settings.



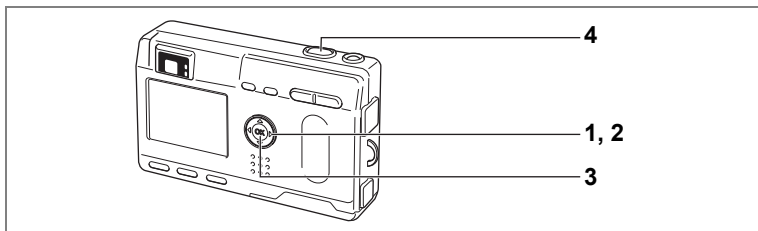

## Taking Pictures of Dark Scenes (Night-Scene Mode)

You can choose settings appropriate for taking pictures of dark scenes, such as nightscapes.

### 1 Press the four-way controller (▼) in Capture mode.

The virtual mode dial appears.

### 2 Use the four-way controller (◀▶) to display the Night-scene mode (🌃) at the top of the dial.

### 3 Press the OK button.

### 4 Press the shutter release button.

The picture is taken.

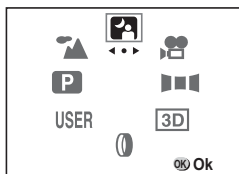

Using the shutter release button ⇨ p.23  
 Playing back still pictures ⇨ p.24



Total shooting time will be longer than the set slow shutter speed when the noise reduction function activates to reduce noise.



The shutter speed is slower when taking pictures of dark scenes. To prevent camera shaking, secure the camera on a tripod or other surface.

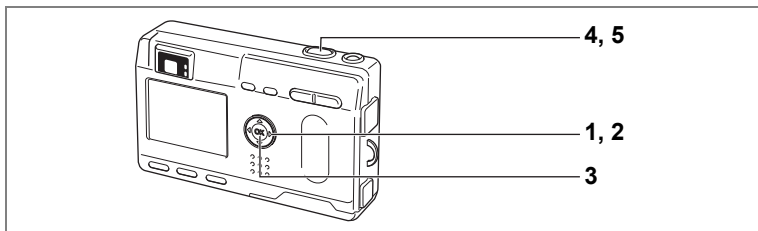

## Taking Movie Pictures (Movie Picture Mode)

This mode enables you to take moving images and sound. The maximum length of one recording (1 set) is approximately 60 seconds.

### 1 Press the four-way controller (▼) in Capture mode.

The virtual mode dial appears.

### 2 Use the four-way controller (◀▶) to display the Movie Picture mode (📹) at the top of the dial.

### 3 Press the OK button.

- 1 Flash off mark
- 2 Movie picture mode icon
- 3 Card/Built-in memory
- 4 Recordable time for next set
- 5 Number of remaining sets

### 4 Press the shutter release button.

Shooting will start. You can change the size of the image using the Zoom button.

⬆ : makes the image bigger.

⬆⬆ : makes the image smaller.

### 5 Press the shutter release button.

Shooting will end.

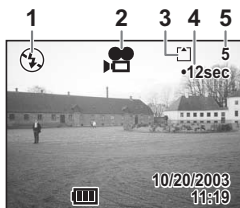

## Keeping the shutter release button pressed

If you keep the shutter release button pressed for more than one second, pictures will be taken for as long as you keep the button pressed. Shooting stops when you take a finger off from the shutter release button.

Playing Back Movie Pictures  p.80



- The flash will not discharge in Movie Picture mode.
- Continuous shooting is not possible in Movie Picture mode.
- The LCD monitor cannot be turned off in Movie Picture mode.
- Sound cannot be recorded when [Fast Fwd Movie] is set to ON.
- Autofocus mode, Infinity-landscape mode and Manual focus mode can be set in Movie Picture mode. The focus is set to fixed position in Autofocus mode.
- Only the digital zoom can be used to change the size of the image in Movie Picture mode. Use the LCD monitor when recording a movie picture.

Fast Forward Movie Mode  p.73

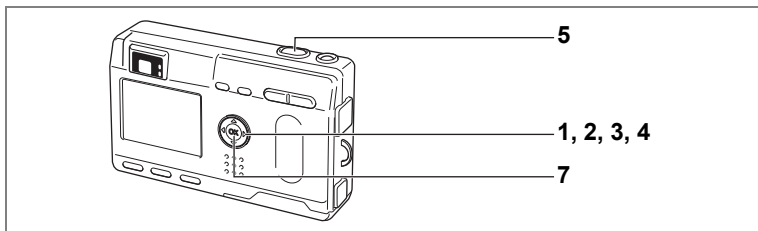

## Taking Panorama Pictures (Panorama Assist Mode)

You can take a number of images and join them together to form a panorama picture. The panorama software provided with the camera and a computer that supports Windows are necessary for joining the images.

4

Taking Pictures

- 1 Press the four-way controller (▼) in Capture mode.**

The virtual mode dial appears.

- 2 Use the four-way controller (◀▶) to display the Panorama Assist mode (■) at the top of the dial.**



- 3 Press the four-way controller (▼).**

- 4 Use the four-way controller to choose the direction in which the images will be joined.**

- ◀ Joins the images at the left.
- ▶ Joins the images at the right.
- ▲ Joins the images at the top.
- ▼ Joins the images at the bottom.

The example shows the images when ▶ is selected.

## 5 Take the first picture.

Press the shutter release button to take the first image. The right edge of the image is displayed in transparent form on the left of the LCD monitor.



## 6 Move the camera to the right and take the second picture.

Repeat the above procedure to take the third and subsequent pictures.

## 7 Press the OK button.

The screen returns to step 4.



To cancel Panorama mode, change to another mode.



- The camera cannot join the images. Use the panorama software provided with the camera.
- Continuous shooting is not possible in Panorama Assist mode.
- A computer that supports Windows is necessary for joining images to form a panorama picture. (The software provided with the camera is not supported by Macintosh.)

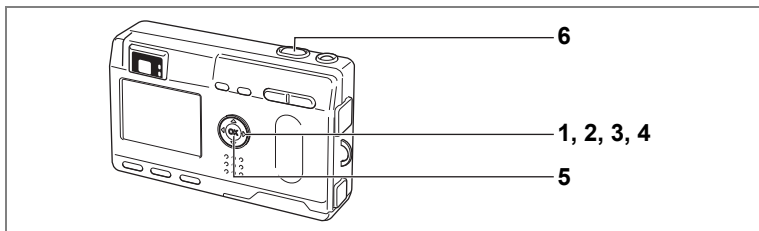

## Taking Pictures with Digital Filters (Digital Filter Mode)

You can take pictures using digital filters. The filters consist of color filters such as red, blue and green, and a slim filter that produces a slim effect.

### • Color Filters

Eight color filters are provided: black-and-white, sepia, red, pink, violet, blue, green and yellow. When you select a color filter in the Digital Filter mode, the display on the LCD monitor is filtered with the selected color, and the pictures are taken in that color.

### • Slim Filter

You can set the degree of slimness in 8 steps vertically or horizontally.

- 1 Press the four-way controller (▼) in Capture mode.**  
The virtual mode dial is displayed.
- 2 Use the four-way controller (◀▶) to display the Digital Filter mode (0) at the top of the dial.**
- 3 Press the four-way controller (▼).**  
The filter options screen is displayed.
- 4 Use the four-way controller (▲▼) to select the filter.**
- 5 Press the OK button.**
- 6 Press the shutter release button.**  
The picture is taken.

## Setting the slim filter [人]

When you select the slim filter in Digital Filter Mode, the slimness setting screen is displayed.

### 1 Use the four-way controller (◀▶) to set the slimness.

 Decreases slimness.

 Increases slimness.

### 2 Press the OK button.

The camera returns to digital filter mode.



The digital zoom cannot be used when the slim filter is selected.

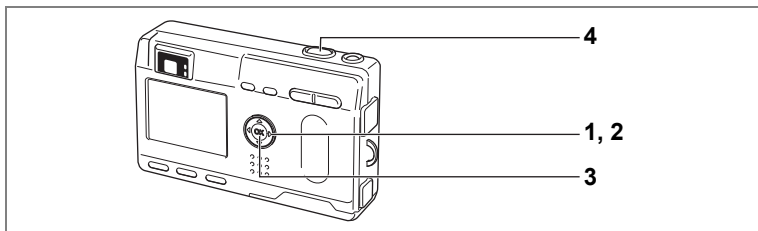

## Using Preset Function Settings (User Mode)

In User mode, you can take pictures using the functions and settings registered in advance in User mode.

- 1 Press the four-way controller (▼) in Capture mode.**

The virtual mode dial appears.

- 2 Use the four-way controller (◀▶) to display the User mode (USER) at the top of the dial.**

- 3 Press the OK button.**

- 4 Press the shutter release button.**

The picture is taken.



Registering Functions in User Mode p.75



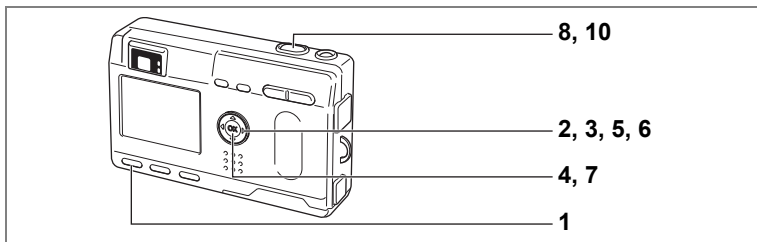

## Taking Stereo Pictures (3D Image Mode)

You can take 3D pictures using the LCD monitor and view them by the parallel method or cross method (p.65). If you print out the 3D pictures and look at them through the 3D image viewer provided, the image will appear in three dimensions.

### Select the viewing mode.

The default setting is [Parallel]. If you do not need to switch to [Cross], go to Step 5.

**1 Press the MENU button.**  
The [Rec. Mode] menu will be displayed.

**2 Press the four-way controller (▲▼) to select [3D Mode].**

**3 Use the four-way controller (◀▶) to select [Parallel].**

To view the picture with the 3D image viewer, select [Parallel].

You can also view it without the image viewer.

**4 Press the OK button.**  
The 3D image mode screen appears again.

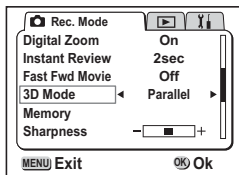

### Take the pictures

**5 Press the four-way controller (▼) in Capture Mode.**  
The virtual mode dial appears.

**6 Use the four-way controller (◀▶) to display the 3D mode (3D) at the top of the dial.**

## 7 Press the OK button.

The screen for taking the first image appears in the left half of the LCD monitor.

## 8 Take the first image.

Hold the camera so that the subject is in the middle of the left half of the screen and press the shutter release button. The image is displayed in the left half of the LCD monitor. The right half of the screen is for taking the second image.

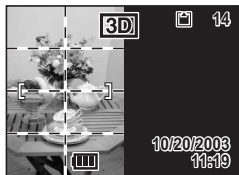

## 9 Move the camera to the right without changing your stance.

## 10 Take the second image.

Make sure that the subject is in the middle of the right half of the screen and press the shutter release button.

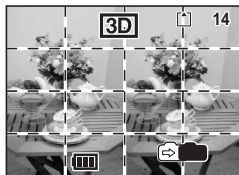

- To cancel the 3D image mode change to another Capture mode.
- A clear three-dimensional effect will not be achieved if the two images are taken in widely different positions (heights) or are not straight. When taking a person, you are recommended to ask your model to stay as still as possible and to take the second picture as quickly as you can. It is easier to take the pictures if you use a tripod or appropriate base.
- As a guide, the camera should be moved about  $1/40$  of the distance between the camera and the subject. For example, if the subject is 3m away, the distance the camera should be moved will be  $3\text{m} \div 40 = 7.5\text{cm}$ .

However, as the way people see three-dimensional images differs from person to person, there is no need to be too concerned. Refer to the table below for a simple guide to how far to move the camera.

Distance to subject	0.1m	0.3m	0.5m	1m	3m	5m
Camera movement	0.5cm	1cm	1.5cm	2.5cm	7.5cm	13cm

- **Viewing 3D pictures by the parallel method and cross method**

As our eyes are positioned about 6 - 7 cm apart, there is a very slight deviation between what we see with our right eye and what we see with our left eye. The difference is processed by our brain to produce a three-dimensional image. This principle is applied to taking and viewing 3D pictures.

3D pictures can be viewed by the parallel method where the left and right lines of vision are virtually parallel, as when looking at a distant scene, or the cross method where the left and right lines of vision are crossed, as when you cross your eyes. A certain amount of practice may be necessary to view 3D pictures without using the viewer.

- **How to Assemble the 3D Image Viewer**

Assemble the 3D image viewer supplied with the camera as shown below.

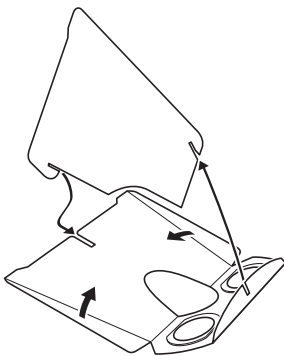

### • How to view 3D pictures using the 3D image viewer

Print out the pictures so that they are about 11cm or 12cm wide and place the divider of the 3D image viewer in the middle of the two.

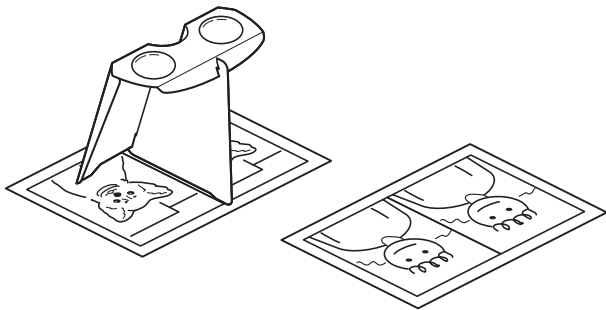

4



As the distance between the left and right eyes differs from person to person, some people may have difficulty obtaining a three-dimensional effect even when looking at prints that are the same size. It may be especially difficult if the pictures are very large or very small. Try different sizes until the right effect is achieved.



- Never look at the sun through the 3D image viewer.
- Do not leave the 3D image viewer where it is exposed to direct sunlight as this may lead to fire.

- Example of a 3D Picture



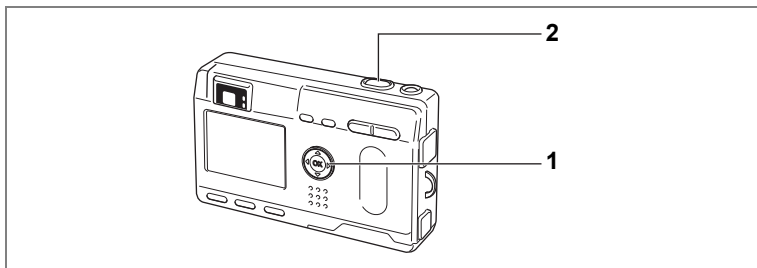

**P** Picture Mode **USER**

## Continuous Shooting (Continuous Shooting Mode)

Pictures are taken continuously while the shutter release button is pressed.

- 1 Press the four-way controller (▲) button to display  on the LCD monitor.**



- 2 Press the shutter release button.**

Pictures will be taken continuously while the shutter release button is pressed. Shooting stops when you take a finger off from the shutter release button.

Playing Back Images  p.24



- You can continue shooting until the SD Memory Card / MultiMediaCard is full.
- The interval will vary according to the [Recorded Pixels] and [Quality Level] setting.



- The flash will not discharge in Continuous Shooting mode.
- Continuous shooting is not available for Movie Picture, Panorama Assist and 3D Image modes.

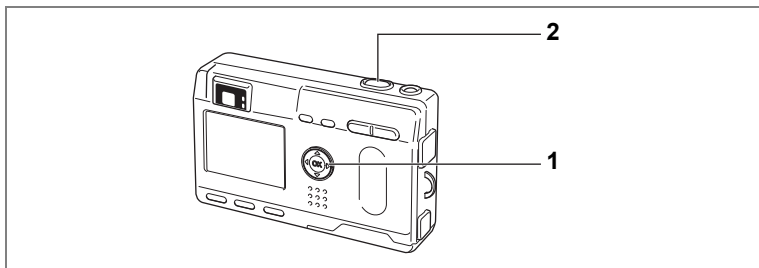

**P** Picture Mode USER

## Using the Self-Timer

The picture will be taken 10 seconds after the shutter release button is pressed.

- 1 Press the four-way controller (▲) in Capture mode to display on the LCD monitor.**
- 2 Press the shutter release button.**

The self-timer is engaged and the self-timer lamp lights. The picture is taken approximately 3 seconds after the self-timer lamp starts to blink.



- If you turn the LCD monitor on, the second count will be displayed.
- To cancel the self-timer, press the four-way controller or the Menu button while the second count is displayed.
- In 3D Image mode, both the first and second images will be taken with the self-timer engaged.

Playing Back Still Pictures p.24  
Taking a Picture of Yourself p.54

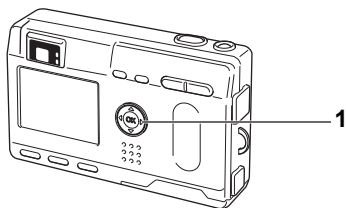

**P** Picture Mode USER

## Using the Remote Control Unit (optional)

4

Taking Pictures

You can take pictures using the remote control F (optional).

- 1 Press the four-way controller (▲) in Capture mode to display (3S) on the LCD monitor.**

The self-timer lamp will blink and the camera is ready to take pictures.

- 2 Press the shutter release button on the remote control unit.**

The self-timer lamp will blink rapidly and the picture will be taken after approximately three seconds.



Playing Back Images p.79



- The buttons on the camera can be used in the same way.
- Please ensure that the remote control unit is no more than 4 meters away from the front of the camera.
- To take a picture immediately after pressing the shutter release button on the remote control unit, press the four-way controller in step 1 to display on the LCD monitor.
- You can use the remote control E (optional) to operate the zoom.

### • Life of the Battery for the Remote Control Unit

A signal can be sent from the remote control unit to the camera approximately 30,000 times. If the battery needs changing, contact your nearest Pentax customer service center. (A charge is made for changing the battery.)



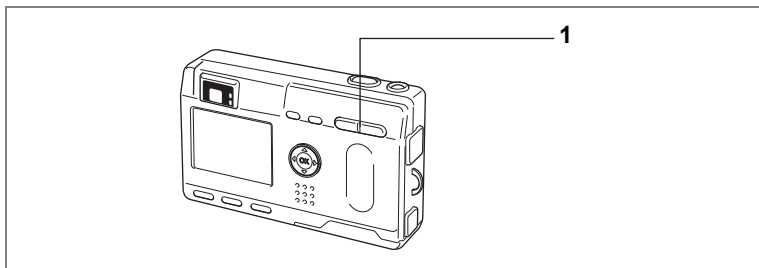

**P** Picture Mode USER

## Using the Zoom

You can use the zoom to take pictures in Tele or Wide mode.

### 1 Press the Zoom button in Capture mode.

- ⬆ : makes the subject larger
- ⬆⬆⬆ : makes the subject smaller

When the digital zoom function is disabled, you can take pictures at up to 3 times magnification using the optical zoom. When the digital zoom is enabled, you can further enlarge the subject to a maximum magnification equivalent to 12 times.

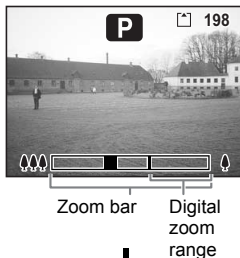

When digital zoom is enabled

Saving the Zoom Position p.74



You cannot use the optical zoom in Movie Picture mode.

## Enabling the Digital Zoom Function

### 1 Press the MENU button in Capture mode.

The [📷 Rec.Mode] menu will be displayed.

### 2 Press the four-way controller (▲▼) to select [Digital Zoom].

### 3 Use the four-way controller (◀▶) to select [On].

### 4 Press the OK button.

The camera is ready to take a picture.

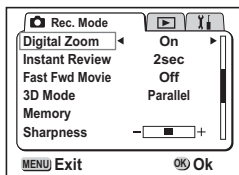

- When you turn the LCD monitor off, the digital zoom is disabled even if the digital zoom function is set to On.
- If [Slim] has been selected for the digital filter, you cannot use the digital zoom.



When you use the digital zoom function, the object should be focused by the LCD monitor.

Saving the Digital Zoom Function Setting p.74

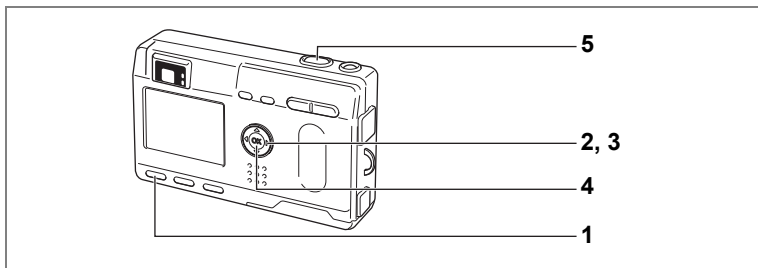

## Taking Time-lapse Movie Pictures (Fast Fwd Movie)

This mode lets you take movie pictures at a delayed frame rate so that when you play the movie back, the action appears speeded up. This function is useful for recording a blooming flowers, etc.

- 1 Press the MENU button in Movie Picture mode.**  
The [📷 Rec.Mode] menu will be displayed.
- 2 Press the four-way controller (▼) to select [Fast Fwd Movie].**
- 3 Use the four-way controller (◀▶) to choose [Off (×1)], [×2], [×5], [×10], [×20], [×50] or [×100].**
- 4 Press the OK button.**
- 5 Press the shutter release button.**



- Off (×1) is the normal setting for movie pictures (12 frames per second). Each time ×2 or ×5 is selected, the number of frames taken per second is reduced to 1/2 or 1/5.
- As movie pictures are normally played back at the rate of 12 frames per second, movies taken at ×2 are played back twice as fast and movies taken at ×5 are played back five times as fast.
- Sound cannot be recorded.

Movie Picture Mode 📷 p.56

# Saving the Settings (Memory)

## Saving the Menu Items (Memory)

You can choose whether you want the set values to be saved when the camera is turned off. If you select  [On], the settings will be saved in the status they were in immediately before the camera was turned off. If you select  [Off], the settings will be reset to the defaults when the camera is turned off.

Item	Description	Default Setting
Flash	The flash mode setting on the # button is saved.	<input checked="" type="checkbox"/>
White Balance	The [White Balance] setting on the [Rec.Mode] menu is saved.	<input type="checkbox"/>
EV compensation	The set EV compensation value is saved.	<input type="checkbox"/>
Digital Zoom	The [Digital Zoom] setting on the [Rec.Mode] menu is saved.	<input checked="" type="checkbox"/>
AE Metering	The [AE Metering] setting on the [Rec.Mode] menu is saved.	<input type="checkbox"/>
Sensitivity	The [Sensitivity] setting on the [Rec.Mode] menu is saved.	<input type="checkbox"/>
Focus Mode	The focus mode setting is saved.	<input type="checkbox"/>
Zoom Position	The zoom position setting is saved.	<input type="checkbox"/>
MF	The manual focus position is saved.	
DISPLAY	The LCD monitor display mode is saved.	<input type="checkbox"/>
File #	The file number is saved. If a new SD Memory Card/MultiMediaCard is inserted, the sequential file number is assigned.	<input checked="" type="checkbox"/>



- Menu items not included in [Memory] will also be saved in the settings selected on the menus for each function when the camera is turned off.
- The zoom position setting in the digital zoom range will not be saved even if [Zoom Position] is set to On in [Memory].
- [Memory] can be set separately in User mode and other shooting modes.

- 1 Press the MENU button in Capture mode.
- 2 Press the four-way controller (▲▼) to select [Memory].
- 3 Press the four-way controller (▶). [Memory] menu will be displayed.
- 4 Use the four-way controller (▲▼) to select the item.
- 5 Press the four-way controller (◀▶) to select  [On] or  [Off].
- 6 Press the OK button twice.  
The camera is ready to take the picture.

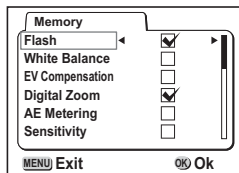
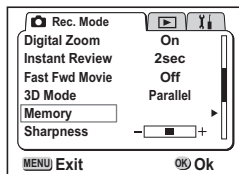

## Register Functions in User Mode

Functions set with the Capture Mode on User will be registered in User mode.

### • Functions registered in User mode

Items registered in User mode	Default setting	Page
Flash mode	Auto	p.39
Drive mode	Normal	p.68~70
Focus mode	Autofocus	p.37
Manual focus position	Infinity	p.38
Recorded pixels	2304×1728	p.41
Quality	★★	p.42
White balance	AWB (auto)	p.43
Focusing area	Multiple	p.45
AE metering	(Multi segment)	p.46
Sensitivity	Auto	p.47
Digital zoom	On	p.71
Instant review	1 sec	p.48
Mode memory	All On	p.74
Sharpness	Normal	p.49
Saturation	Normal	p.50
Contrast	Normal	p.51
Fn settings	EV compensation	p.106

## Recording Sound (Voice Recorder Mode)

You can record sound. The recordable time is displayed on the LCD monitor according to how much space is available on the SD Memory Card / MultiMediaCard.

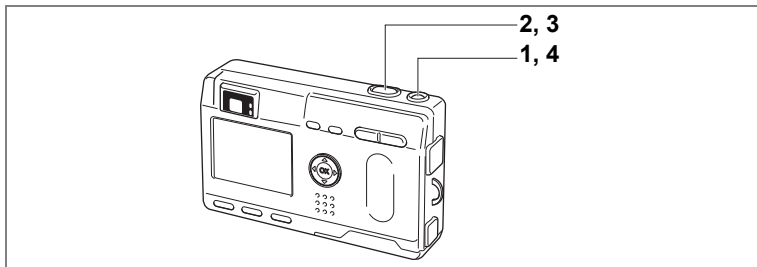

### 1 Press the power switch for more than 2 seconds.

The power switch is illuminated by a red light.

The recordable time is displayed on the LCD monitor.

1 Remaining recordable time

2 Recording time

### 2 Press the shutter release button.

Recording starts. The self-timer lamp and flash status lamp light during recording.

### 3 Press the shutter release button.

Recording stops. The remaining recordable time is displayed.

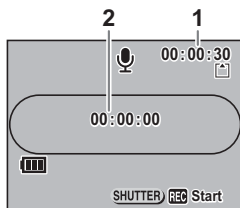

### 4 To exit Voice Recorder mode, turn the camera off.



- When you press the power switch, the lens extends, then retracts immediately and the camera enters the Voice Recorder mode.
- Sound is saved in WAVE monaural files.
- The microphone is located on the front of the camera. Aim the camera to obtain the best sound.
- An index can be added by pressing the MENU button during recording.
- When the shutter release button is pressed for more than 1 second after recording has started, recording continues for as long as the button is held down and stops when the button is released.

# Playing Back Sound

You can play back the recording you made in Voice Recorder Mode.

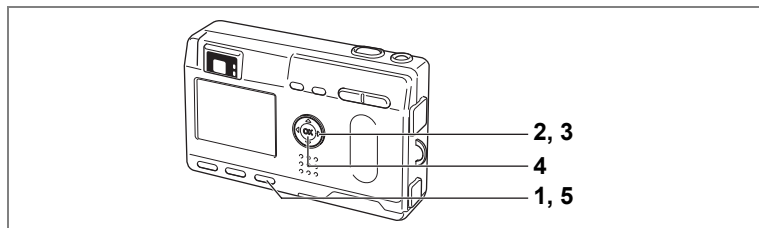

- 1 Enter the Voice Recorder Mode and press the Playback button.**
- 2 Use the four-way controller (◀▶) to select the recording you want to play back.**
- 3 Press the four-way controller (▲).**  
Playback will start.



File recording time

• **The following operations can be performed during playback.**

Four-way controller (▲) Pauses playback  
Press again to resume playback

If there are no recorded indexes:

Four-way controller (◀) Rewinds 5 seconds  
Four-way controller (▶) Advances 5 seconds

If there are recorded indexes:

Four-way controller (◀) Plays back from the previous data  
Four-way controller (▶) Plays back from the next data

Zoom/☒/Q button (⬇) Increases the volume

Zoom/☒/Q button (⬆) Reduces the volume

- 4 Press the OK button.**

Playback will end.

- 5 Press the Playback button.**

The camera will switch to the Voice Recorder Mode.

# Adding a Voice Memo

You can add a voice memo to a captured image.

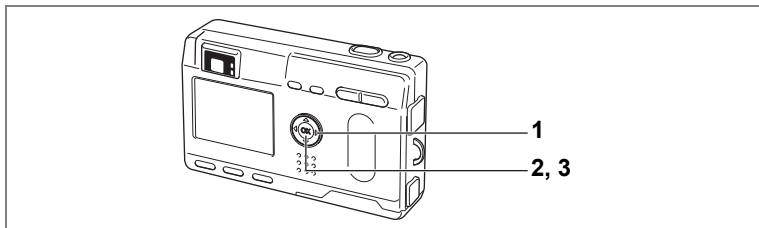

- 1 Enter the playback mode and choose the image to which you want to add a voice memo with the four-way controller (◀▶).**

The voice memo screen will be displayed on the LCD monitor while the image is displayed.



- 2 Press the OK button.**

Recording starts. You can record for up to 30 seconds.

- 3 Press the OK button.**

Recording stops.



- A voice memo cannot be added to an image which already has a voice memo.
-  appears on the screen when a voice memo is added.



A voice memo cannot be added to protected (Ⓞ) images.

## Setting the Record Voice Memo to [Off].

- 1 Select [Record Voice Memo] on the playback menu.**
- 2 Use the four-way controller(◀▶) to select [Off].**
- 3 Press the OK button.**  
() will disappear).



# Playing Back Images

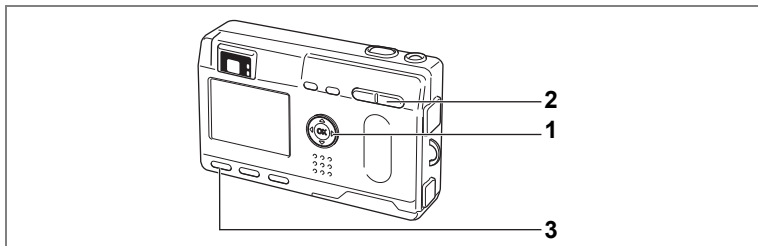

## Playing Back Still Pictures

See “Playing Back Images” (p.24), or “Playing Back Previous or Next Images” (p.24).

## Zoom Display

You can display images magnified up to a maximum of 4 times. A guide to operation is displayed on the LCD monitor during magnification. (The magnification varies depending on the number of recorded pixels.)

**1 Enter the Playback mode and choose the image you want to magnify with the four-way controller (◀▶).**

**2 Press ▲/Q on the Zoom/Erase/Quick button.**

The image will be magnified (1× to 4×). If you keep pressing (▲), the magnification of image will be changed continuously.

- **The following operations can be performed while the magnified image is displayed.**

Four-way controller (▲▼◀▶)	: Moves the position to be magnified
Zoom/Erase/Quick button (▲)	: Makes the image larger
Zoom/Erase/Quick button (◆◆◆)	: Makes the image smaller
Display button	: Turns the guide marks on/off

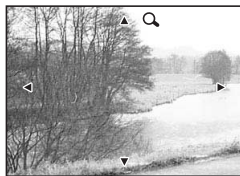

**3 Press the MENU button.**

Zoom playback will end.



- The movie pictures cannot be magnified.
- If the camera is turned on in Playback Only mode, pressing the Playback button will not change the mode to Capture mode. Turn the camera off and then turn it on again.

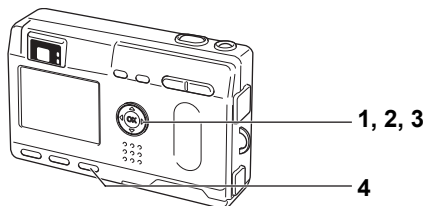

## Playing Back Movie Pictures

You can play back Movie pictures. A guide to operation is displayed on the LCD monitor during playback. You can play back the recording you made in Voice Recorder mode at the same time.

**1 Enter the Playback mode and choose the movie picture you want to play back with the four-way controller (◀▶).**

**2 Press the four-way controller (▲).**

Playback will start.

• **The following operations can be performed during playback.**

Four-way controller (◀) : Reverse playback

Four-way controller (▶) : Forward playback

Four-way controller (▲) : Pause

Display button: Changes the Display mode

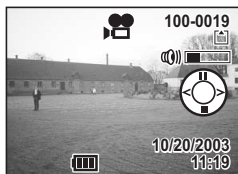

• **The following operations can be performed while Pause is engaged.**

Four-way controller (◀) : Frame reverse

Four-way controller (▶) : Frame forward

Four-way controller (▲) : Releases the Pause function

Display button: Changes the Display mode

**3 Press the four-way controller (▼).**

Movie playback will end.

**4 Press the Playback button.**

The camera will return to Capture mode.

## Displaying shooting information in Playback mode

Shooting information can be displayed on the LCD monitor. Pressing the Display button switches the information displayed.

### Display On

Displays shooting information.

- 1 Voice Memo icon
- 2 Protect icon
- 3 Folder name
- 4 File name
- 5 Card / Built-in memory icon
- 6 Four-way controller operation guide
- 7 Shooting date and time
- 8 Battery icon

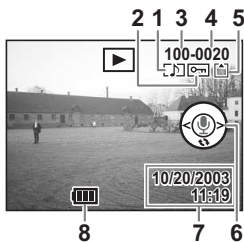

### Histogram Display

Displays the brightness distribution across the image. The horizontal axis shows brightness (left end is darkest, and right end is brightest), and the vertical axis shows the pixels.

- |               |                   |
|---------------|-------------------|
| 1 Histogram   | 2 Recorded pixels |
| 3 Quality     | 4 White balance   |
| 5 AE metering | 6 Sensitivity     |
| 7 F number    | 8 Shutter speed   |

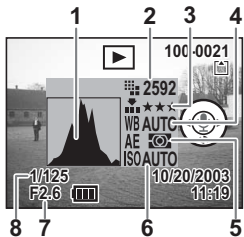

### Display Off

Does not display shooting information.



Display On

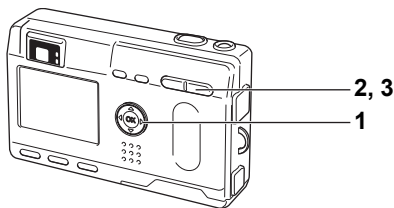

## Nine Image Display

You can display nine images at the same time.

- 1** Enter the Playback mode and choose an image with the four-way controller (◀▶).
- 2** Press /◻ on the Zoom button /Q.

Nine images will be displayed with the selected image in the center. Choose an image with the four-way controller (▲▼◀▶).



Selected image

When 10 or more images have been recorded, the previous 9 images will be displayed if you press the four-way controller (◀) while an image on the left row is selected. If you press the four-way controller (▶) while an image on the right row is selected, next 9 images will be displayed.

- 3** Press /◻ on the Zoom button /Q.

The screen will return to single-image display of the selected image.

\* In case of movies, a single-frame image will be displayed.

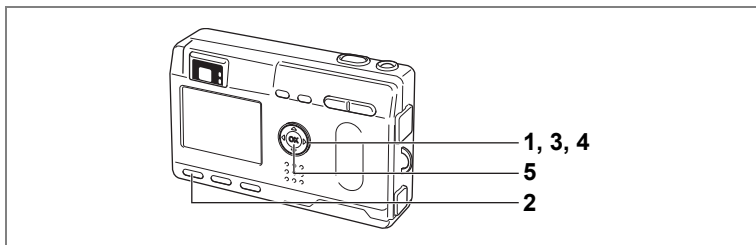

## Slideshow

You can play back all the images on the SD Memory Card/ MultiMediaCard continuously.

**1 Enter the Playback mode and choose the image with which to start the slideshow with the four-way controller (◀▶).**

**2 Press the MENU button.**

The [▶] Playback menu will be displayed.

**3 Select [Slideshow] with the four-way controller (▼).**

**4 Use the four-way controller (◀▶) to change the playback interval.**

Choose from the following: 3 sec, 5 sec, 10 sec, 15 sec, 20 sec, 25 sec, 30 sec.

**5 Press the OK button.**

Playback will start at the set interval.

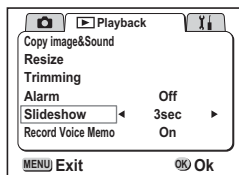

- If you press the OK button during continuous playback, the slideshow will stop.
- The slideshow will continue until you press any button.
- Movie pictures and pictures with a voice memo will be played through to the end before the next picture is played back, regardless of the set playback interval.
- Recordings made in Voice Recorder mode are not played back.

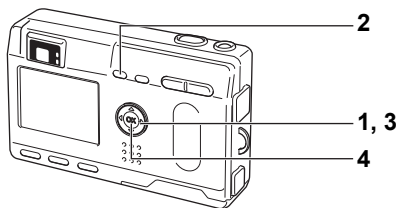

# Erasing Images



## Erasing a Single Image or Voice Memo

- 1 Enter the Playback mode and choose the image or voice memo you want to erase with the four-way controller (◀▶).**
- 2 Press the  button.**  
The Delete screen will be displayed.
- 3 Select [Delete] with the four-way controller (▲).**
- 4 Press the OK button.**



- You can also delete images from Instant Review (p.48).
- You cannot erase protected () images (with the  symbol).
- If [Quick Delete] is set to On in the [Y] Set-up] menu, Step 3 can be omitted.

## Erasing a Voice Memo only

If an image has a voice memo, you can erase the voice memo without erasing the image.

- 1 Enter the Playback mode and choose the image with the voice memo that you want to erase with the four-way controller (◀▶).**
- 2 Press the  button.**  
The Delete screen will be displayed.
- 3 Select [Sound Delete] with the four-way controller (▲).**
- 4 Press the OK button.**

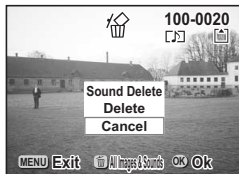

- Select [Delete] in step 3 above to erase both the image and the voice memo.

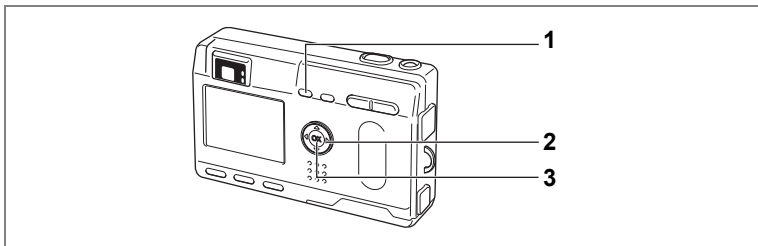



## Erasing All Images

You can erase all the images and sound at once.



- Once erased, images cannot be restored.
- Protected images/sound cannot be erased.

- 1 Enter the Playback mode and press the  button twice.**  
The Delete All screen will be displayed.
- 2 Select [Delete All] with the four-way controller (.**
- 3 Press the OK button.**

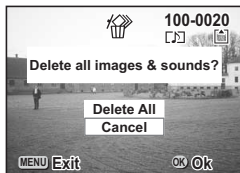



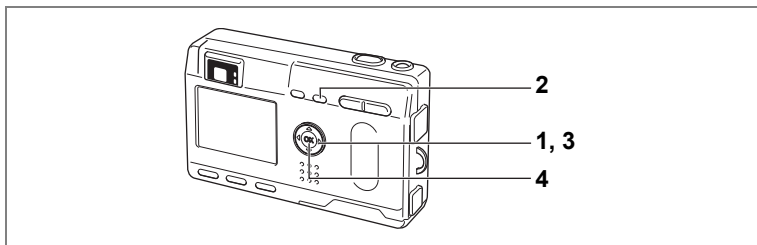

## Protecting Images / sound from Deletion (Protect)

You can protect images/sound from being accidentally erased.

- 1 Enter the Playback mode and choose the image/sound you want to protect with the four-way controller (◀▶).**
- 2 Press the button.**  
The Protect screen will be displayed.
- 3 Select [Protect] with the four-way controller (▲).**
- 4 Press the OK button.**

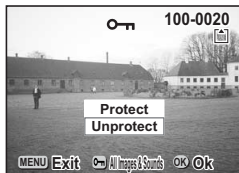

- Select [Unprotect] in step 3 to release the Protect setting.
- If the image is protected, the symbol is displayed when the image/sound is played back.

## Protecting All Images

You can protect all the images.

- 1 Enter the Playback mode.**
- 2 Press the button twice.**  
The Protect All screen will be displayed.
- 3 Select [Protect] with the four-way controller (▲).**
- 4 Press the OK button.**



- Select [Unprotect] in step 3 to cancel the Protect setting on all the images.



Even protected images/sound will be erased by formatting the SD Memory Card / MultiMediaCard.

# Viewing Images on a TV

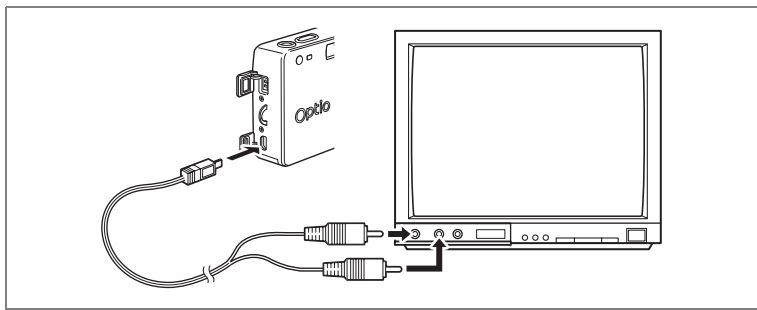

By using the AV cable, you can capture and play back images on a TV or other equipment with a video IN jack. Make sure that both the TV and the camera are turned off before connecting the cable.

- 1 Open the terminal cover and connect the AV cable.
- 2 Connect the other end of the AV cable to the image input terminal and sound input terminal on the TV.
- 3 Turn the TV and camera on.

Changing the Video Output Format  p.103



If you intend to use the camera for a long time, use of the AC adapter (optional) is recommended. Refer to the operating manual for the TV or equipment to which the camera is connected.

# Setting the Printing Service (DPOF)

You can print the images on the SD Memory Card / MultiMediaCard using a DPOF (Digital Print Order Format) compatible printer or at a printing service.

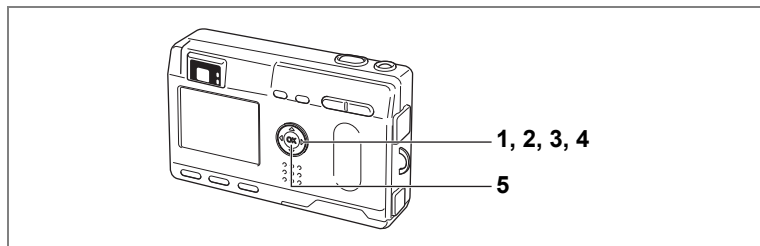

## Printing Single Image

Set the following items for each image.

- **Copies**  
Set the number of prints up to a maximum of 99.
- **Date**  
Specify whether you want the date imprinted on the print or not.

**1** Enter the Playback mode, use the four-way controller (◀▶) to choose the image for which you want to make DPOF settings.

**2** Press the four-way controller (▲) button.

The DPOF menu will be displayed.



**3 Use the four-way controller (◀▶) to select the number of prints, then press the four-way controller (▼).**

The frame will move to [Date].



**4 Use the four-way controller (◀▶) to select whether to insert the date or not.**

- (On): The date will be imprinted.
- (Off): The date will not be imprinted.

**5 Press the OK button.**

Prints can be made according to the settings.



- If DPOF settings have already been made for an image, the previously set number of prints and On/Off date setting will be displayed.
- To cancel DPOF settings, set the number of prints to 0 and press the OK button.

6



- You cannot set the printing service for movie pictures or sound-only files.
- Depending on the printer or printing equipment at the photo processing lab., the date may not be imprinted on the pictures even if the DPOF setting was made.
- DPOF settings cannot be made on the images saved in the Built-in memory. Copy them to the SD Memory Card / MultiMediaCard (p.95) and make DPOF settings.

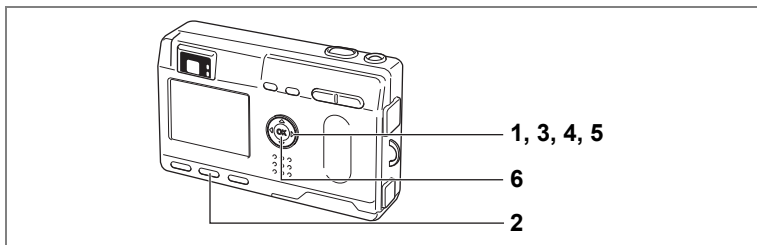

## Printing All Images

- 1** Enter the Playback mode and press the four-way controller (▲).
- 2** Press the Display button.
- 3** Use the four-way controller (◀▶) to select the number of prints.  
You can print up to 99 copies.
- 4** Press the four-way controller (▼).  
The frame will move to [Date].
- 5** Press the four-way controller (◀▶) to select  [On] or  [Off].
  - (On):The date will be printed.
  - (Off):The date will not be printed.
- 6** Press the OK button.  
Prints can be made according to the settings.



- The setting for a single image will be cancelled.
- When you specify the number of prints in the DPOF setting, the number applies to all the images. Before printing, check that the number is correct.
- The setting is not possible for movie pictures.

# Editing Images

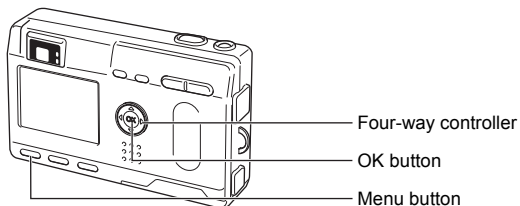

## Changing the Image Size

By changing the size and quality of a selected image, you can make the file smaller than the original. After changing the size, the image can be saved as a new image or written over the original image.

- 1 Press the MENU button.**
- 2 Press the four-way controller (▶).**  
The [▶ Playback] menu will be displayed.
- 3 Press the four-way controller (▲▼) to select [Resize].**
- 4 Press the four-way controller (▶).**  
The Resize screen will be displayed.
- 5 Use the four-way controller (◀▶) to choose the image to resize.**
- 6 Press the OK button.**



- 7** Press the four-way controller (◀▶) to select [Recorded pixels].
- 8** Press the four-way controller (▼).  
The select frame moves to [Quality Level].
- 9** Press the four-way controller (◀▶) to select [Quality Level].
- 10** Press the OK button.
- 11** Press the four-way controller (▲▼) to select [Overwrite] or [Save as].
- 12** Press the OK button.  
The image will be resized.



- Movie pictures cannot be resized.
- You cannot select a larger size than that of the original image.

## Trimming Images

You can trim part of a picture and save it as a separate image.

**1 Press the MENU button.**

**2 Press the four-way controller (►).**

The [▶] Playback] menu will be displayed.

**3 Press the four-way controller (▲▼) to select [Trimming].**

**4 Press the four-way controller (►).**

The image that can be trimmed.

**5 Choose the image you want to trim with the four-way controller (◀▶).**

**6 Press the OK button.**

The trimming screen will be displayed.



**7 Trim the image.**

• **Operations available on the Trimming screen.**

Zoom/□/Q button:

Changes the size of the image

Four-way controller (▲▼◀▶): Moves the trimming position up, down, right and left

MENU button:

Returns to the screen for selecting an image to trim

**8 Press the OK button.**

The trimmed image will be saved as a separate image with same quality level and recorded pixels of the original image.



Movie pictures cannot be trimmed.



# Copying Files

You can copy files from the Built-in memory to the SD Memory Card/ MultiMediaCard and vice versa.

When files are copied from the Built-in memory to the card, all the files are copied at once. When files are copied from the card to the Built-in memory, the files are checked one at a time before being copied.

- 1 Press the MENU button.**
- 2 Press the four-way controller (▶).**  
The [▶ Playback] menu is displayed.
- 3 Press the four-way controller (▼) to select [Copy Image & Sound].**
- 4 Press the four-way controller (▶).**  
The File Copy screen is displayed. Choose the copying method you want to use.

## To copy from the Built-in memory to the SD Memory Card / MultiMediaCard

- 5 Select the copying method.**  
Select  → **SD** and press the OK button.  
All the files will be copied to the SD Memory Card / MultiMediaCard.

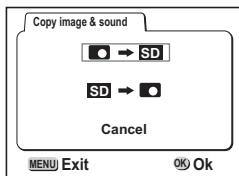

## To copy from the SD Memory Card / MultiMediaCard to the Built-in memory

- 5 Select the copying method.**  
Select **SD** →  and press the OK button.
- 6 Use the four-way controller (◀▶) to select the file you want to copy.**
- 7 Press the OK button.**  
The selected file will be copied to the Built-in memory.



- If the image has a voice memo attached, the sound file will be copied at the same time as the image.
- When a file is copied from the SD Memory Card / MultiMediaCard to the Built-in memory, it is assigned a new file name.
- Be sure to turn the camera off before inserting or removing the SD Memory Card / MultiMediaCard.

## How to recall the [i Set-up] menu

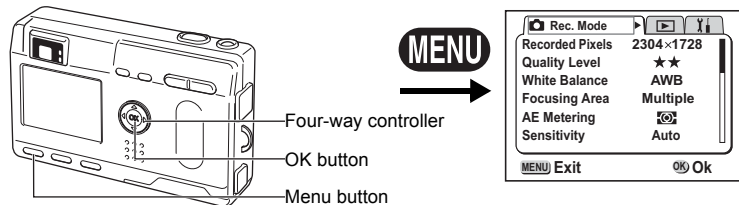

## Formatting a SD Memory Card / MultiMediaCard and the Built-in memory

Formatting will delete all the data on the SD Memory Card/ MultiMediaCard if you are using a card, and all the data in the Built-in memory if there is no card inserted.



- Do not remove the SD Memory Card / MultiMediaCard while the card is being formatted. The card may be damaged and become unusable.
- Formatting will delete protected data too.

7

- 1 Select [Format] on the [i Set-up] menu.**
- 2 Press the four-way controller (▶).**  
The format screen will be displayed.
- 3 Select [Format] with the four-way controller (▲).**
- 4 Press the OK button.**  
Formatting will start. When formatting is completed, the camera is ready to capture images.

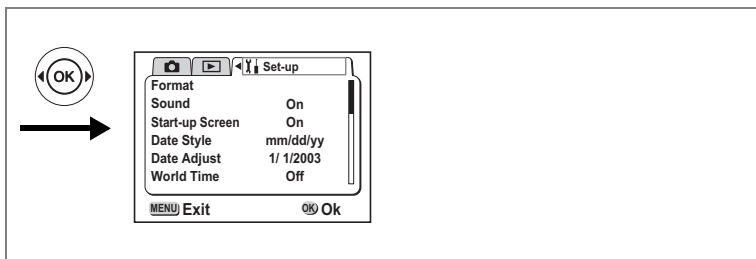

## Changing the Sound Settings

You can change the volume of the playback and operation sounds ([Start-up Sound], [Shutter Sound], [Key Operation Sound], [Focus Sound] and [Self-timer Sound]).

You can also change the type of each sound.

### Changing the volume of playback and operation sounds

- 1 Select [Playback Volume] on the Set-up menu.
- 2 Use the four-way controller (◀▶) to change the volume.
- 3 Press the four-way controller (▼) to select [Operation Volume]
- 4 Use the four-way controller (◀▶) to change the volume.
- 5 Press the OK button twice.

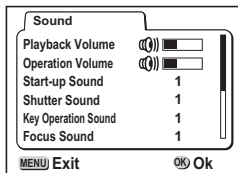

The camera is ready to capture or play back images.

### Selecting the type of start-up sound, shutter sound, key operation sound, focus sound and self-timer sound

- 1 Select [Start-up Sound] on the Set-up menu.
- 2 Use the four-way controller (◀▶) to choose [1], [2], [3] or [Off].
- 3 Change the [Shutter Sound], [Key Operation Sound], [Focus Sound] and [Self-timer Sound] in the same way.
- 4 Press the OK button twice.

The camera is ready to capture or play back images.

## How to recall the [M] Set-up menu

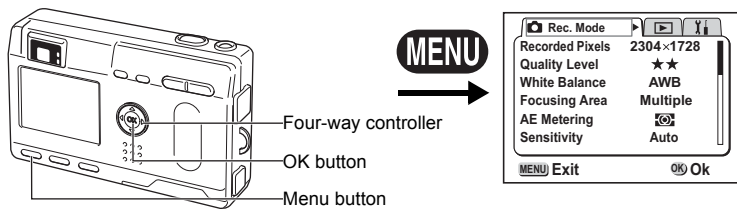

## Changing the Start-up Screen

You can display an image recorded with the camera as the welcome screen when the camera is turned on.

- 1 Select [Start-up Screen] on the [M] Set-up menu.**
- 2 Press the four-way controller (▶).**
- 3 Press the Display button.**
- 4 Use the four-way controller (◀▶) to choose the image you want to display as the start-up screen.**
- 5 Press the OK button.**
- 6 Use the four-way controller (◀▶) to select  [On] or  [Off].**
- 7 Press the OK button twice.**

The camera is ready to take or play back images.



Once the welcome screen has been set, it will not be erased even if the original image is deleted or the SD Memory Card / MultiMediaCard is formatted.

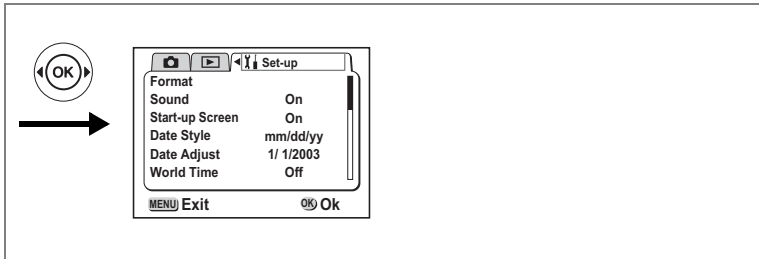

## Setting the Date Style

You can set the style in which the date is displayed on the camera. Choose [mm/dd/yy], [dd/mm/yy] or [yy/mm/dd].

- 1 Select [Date Style] on the [Set-up] menu.**
- 2 Use the four-way controller (◀▶) to change the date style.**
- 3 Press the OK button.**

The camera is ready to capture or play back images with the selected date style.



The style in which the time is displayed is set by [Date Adjust].

## How to recall the [Yi Set-up] menu

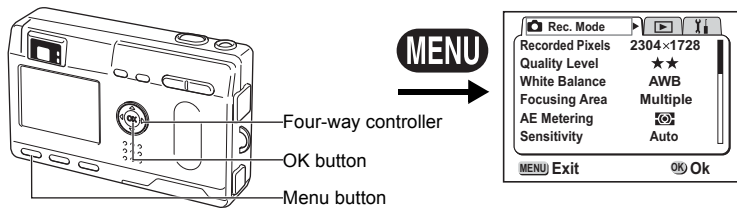

## Changing the Date/Time

You can change the initial date and time settings.

- 1 Select [Date Adjust] on the [Yi Set-up] menu.**
- 2 Press the four-way controller (▶).**  
The date screen will be displayed.

See “Setting the Date and Time” (p.20) for the setting procedure.

## Setting the World Time

The city and time selected in “Initial Settings” (p.18) serve as the Home Time setting.

You can display the time in a city other than the Home Time city (World Time) when shooting or playing back.

- 1 Select [World Time] on the [Yi Set-up] menu.**
- 2 Press the four-way controller (▶).**  
The World Time screen will be displayed.

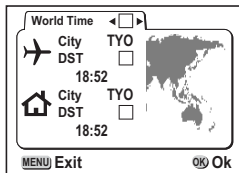

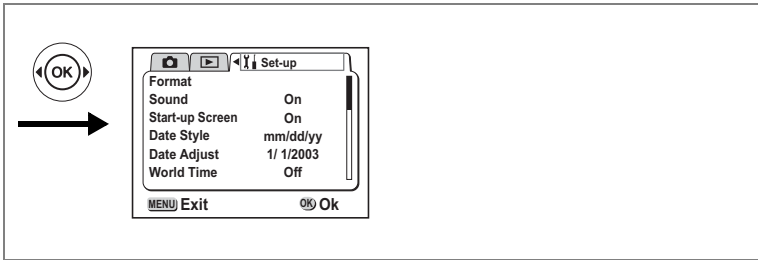

- 3 **Switch [] and [] with the four-way controller (◀▶).**
  - : The time in the country selected in World Time will be displayed.
  - : The time in the country selected in Home Time will be displayed.
- 4 **Press the four-way controller (▼).**

If New York is selected as the world time city, then the cross-shapes line is located in New York on the world map, and then → indicates the current time in New York (NYC).
- 5 **Use the four-way controller (◀▶) to select the World Time city and press the four-way controller (▼).**

◀▶ on the LCD monitor will move to (\*).
- 6 **Select [DST] On (\*) or Off (\*) with the four-way controller (◀▶) and press the four-way controller (▼).**

The frame will move to [↕] (home time city).  
Use the four-way controller (◀▶) to change the Home Time city and DST setting.
- 7 **Press the OK button twice.**

The camera is ready to capture or play back images with the time in the selected city.



See p.110 for the list of cities and code names.





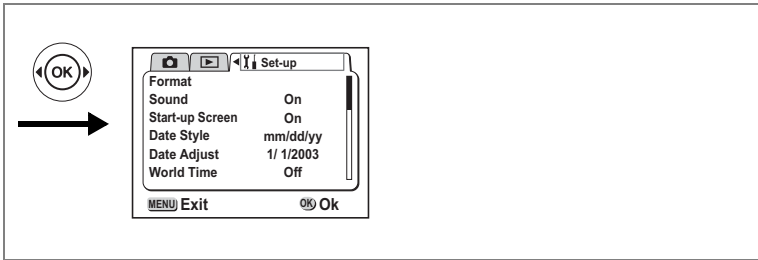

## Changing the Video Output Format

You can select the output format (NTSC or PAL) for taking or playing back images on a TV monitor.

- 1 Select [Video Out] on the [Set-up] menu.**
- 2 Use the four-way controller (◀▶) to change the video output format.**
- 3 Press the OK button.**

The camera is ready to take or play back images.



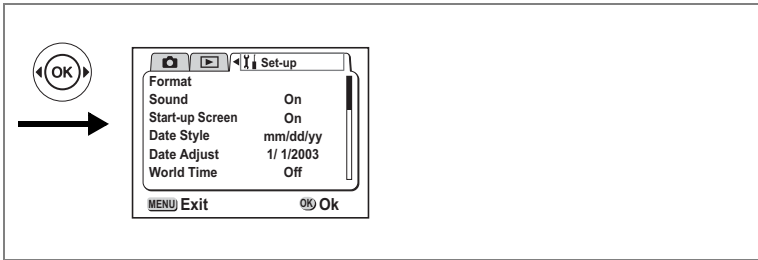

## Setting the Quick Delete Function

When the Quick Delete function is set to On, the Delete screen will be displayed when [Delete] or [Delete All] is selected.

- 1** Select [Quick Delete] on the [Set-up] menu.
- 2** Use the four-way controller (◀▶) to select [On] or [Off]
- 3** Press the OK button.

The camera is ready to capture or play back images.

## Setting the Quick Zoom Function

When the Quick Zoom function is set to On, images can be displayed at maximum magnification simply by pressing the Zoom button once during zoom playback.

- 1** Select [Quick Zoom] on the [Set-up] menu.
- 2** Use the four-way controller to select [On] or [Off]
- 3** Press the OK button.

The camera is ready to capture or play back images.



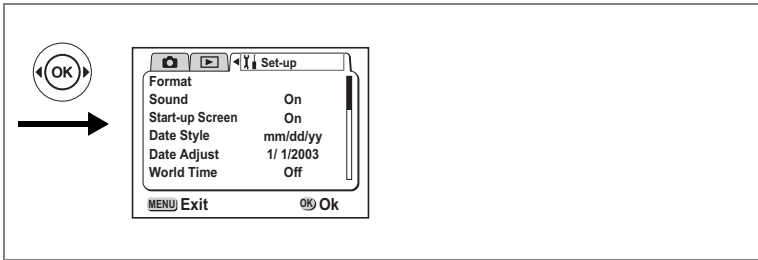

## Resetting to Default Settings (Reset)

You can reset all the settings other than the date and time, language, world time and alarm.

- 1 Select [Reset] on the [Set-up] menu.**
- 2 Press the four-way controller button (▶).**  
The Reset screen will be displayed.
- 3 Use the four-way controller (▲) to select [Reset].**
- 4 Press the OK button.**  
The camera is ready to capture or play back images.

# Setting the Alarm

You can set the alarm to ring at a specified time and display a selected image.

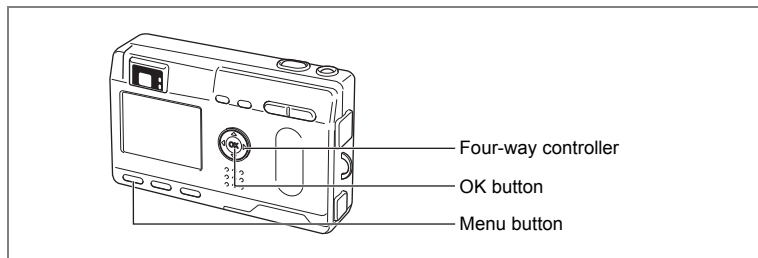

## Checking the Alarm

- 1 Press the MENU button.**
- 2 Press the four-way controller (▶).**  
The [▶ Playback] menu will be displayed.
- 3 Press the four-way controller (▲▼) to select [Alarm].**
- 4 Press the four-way controller (▶).**  
The list of alarms will be displayed.  
Active alarms are indicated by .
- 5 Press the OK button twice.**  
If any alarms are enabled, the camera will be turned off and the alarms will be set.

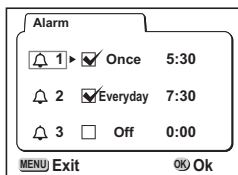

## Setting the Alarm

- 1 Press the MENU button.**
- 2 Press the four-way controller (▶).**  
The [▶ Playback] menu will be displayed.
- 3 Press the four-way controller (▲▼) to select [Alarm].**

#### 4 Press the four-way controller (▶).

The list of alarms will be displayed.

#### 5 Press the four-way controller (▲▼) to select alarm 1-3.

#### 6 Press the four-way controller (▶).

The screen for setting the alarm mode and time will be displayed.

Four-way controller (◀▶): Selects the item.

Four-way controller (▲▼): Changes the setting.

#### 7 Press the Display button.

#### 8 Press the four-way controller (◀▶) to select the image to be displayed when the alarm rings.

#### 9 Press the OK button.

#### 10 Press the OK button 3 times.

The camera will turn off.

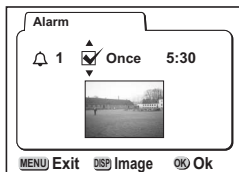
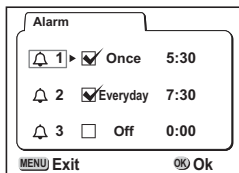

## Turning the Alarm Off

When the camera is turned off and the set time is reached, the alarm will ring for one minute .

The camera will turn off automatically when the alarm has finished ringing.



To stop the alarm ringing, press any button.



The alarm will not ring when the camera is turned on.

## List of City Names

Refer to following list of city and code names for setting the world time..

Code	City names	Code	City names
TYO	Tokyo	JNB	Johannesburg
GUM	Guam	IST	Instanbul
SYD	Sydney	CAI	Cairo
NOU	Noumea	JRS	Jerusalem
WLG	Wellington	MOW	Moscow
AKL	Auckland	JED	Jeddah
PPG	Pagopago	THR	Tehran
HNL	Honolulu	DXB	Dubai
ANC	Anchorage	KHI	Karachi
YVR	Vancouver	KBL	Kabul
SFO	San Francisco	MLE	Male
LAX	Los Angeles	DEL	Delhi
YYC	Calgary	CMB	Colombo
DEN	Denver	KTM	Kathmandu
MEX	Mexico City	DAC	Dacca
CHI	Chicago	RGN	Rangoon
MIA	Miami	BKK	Bangkok
YTO	Toronto	KUL	Kuala Lumpur
NYC	New York	VTE	Vientiane
SCL	Santiago	SIN	Singapore
CCS	Caracas	PNH	Phnom Penh
YHZ	Halifax	SGN	Ho Chi Minh
BUE	Buenos Aires	JKT	Jakarta
SAO	Sao Paulo	HKG	Hong Kong
RIO	Rio de Janeiro	PER	Perth
MAD	Madrid	BJS	Beijing
LON	London	SHA	Shanghai
PAR	Paris	MNL	Manila
MIL	Milano	TPE	Taipei
ROM	Rome	SEL	Seoul
BER	Berlin	ADL	Adelaide



## Optional Accessories

A number of dedicated accessories are available for this camera.

AC adapter D-AC8

USB Cable I-USB7

AV Cable I-AVC7

Camera Case O-CC8

Strap O-ST5

Remote control E

Remote control F

Rechargeable lithium-ion battery D-LI8

Battery charger D-BC8

# Messages









Messages such as the following may be displayed on the LCD monitor during camera operation.

Memory Card full Built-in Memory Full	The SD Memory Card / MultiMediaCard or the Built-in memory is full and no more images can be saved. Insert a new SD Memory Card / MultiMediaCard or delete. (p.16, p.84) Change the quality/size and try again. (p.92, p.94)
No image & sound	There are no images or sound on the SD Memory Card / MultiMediaCard or in the Built-in memory.
Camera can not display this image & sound.	You are trying to play back an image in a format not supported by this camera. You may be able to display it on another brand of camera or PC.
Battery depleted.	The battery is exhausted. Recharge the battery or replace with charged battery. (p.12)
Memory card error.	Shooting and playback are impossible due to a problem with SD Memory Card / MultiMediaCard. Try displaying on a PC.
This card is not formatted.	The SD Memory Card / MultiMediaCard you have inserted is unformatted or has been formatted on a PC or other device and is not compatible with this camera. (p.96)
Data being recorded.	The image is being recorded on the SD Memory Card / MultiMediaCard. The protect setting or DPOF setting is being changed.
Formatting...	The SD Memory Card / MultiMediaCard or Built-in memory is being formatted.

Deleting	The image is being deleted.
Image folder could not be created.	The largest file number has been assigned to an image and no more images can be saved. Insert a new SD Memory Card / MultiMediaCard or format the SD Memory Card / MultiMediaCard or Built-in memory. (p.96)
Battery depleted, the image is not stored.	The battery is exhausted. The image you just captured has not been saved. Recharged the battery or replace with charged battery.
Compression error	Compression of the image you captured has failed. Change the recorded pixels or quality levels, and take a picture again.
Data being recorded	The movie picture is being recorded.
Protect all images & sounds	The image you are trying to delete is a protected image.
Alarm was set	The alarm has been enabled.

# Troubleshooting

Problem	Cause	Remedy
Power will not come on	Battery is not installed	Check battery is installed. If not, install battery.
	Battery is installed incorrectly	Check orientation of battery. Reinsert battery with (▲) symbol towards back of camera. (p.13)
	Battery power is low	Insert a charged battery or use the AC adapter.
No image on the LCD monitor	LCD monitor is set to OFF	Press Display button to turn LCD monitor on. (p.40)
	Image is displayed but is hard to see	Image on LCD monitor may be hard to see when taking pictures outside in sunlight.
Shutter will not release	Flash is charging	When flash lamp blinks red, flash is charging and no pictures can be taken. Lamp lights red when charging is completed.
	No available space on SD Memory Card / MultiMediaCard or in Built-in memory	Insert SD Memory Card / MultiMediaCard with available space or delete unwanted images. (p.16, 84)
	Recording	Wait until recording is finished.
Picture is dark	Subject is too far away in a dark environment, such as a night scene.	Picture becomes dark if subject is too far away. Take picture within range of flash.
	Background is dark	When taking a picture of a person against dark background, such as night scene, the person may appear dark if the flash does not reach background even with correct exposure. Set to  mode to ensure both person and background are clear. (p.36)

Problem	Cause	Remedy
Subject is not in focus	Subject difficult to focus on	Subjects difficult to focus on using autofocus: objects with little contrast (blue sky, white walls, etc.), dark objects, finely patterned objects, fast-moving objects, scenery through window or net, etc. Lock focus on another object located at same distance (press shutter release button halfway), then aim at target and press shutter release button fully, or use Manual Focus mode.
	Subject is not in focusing area	Position subject in AF frame (focusing area) in middle of LCD monitor. If the subject is outside the focusing area, aim the camera at the subject and lock the focus (press shutter release button halfway), then compose picture and press the shutter release button fully.
	Subject is too close	Set focus mode on  (Macro) or  (Super Macro). (p.37)
	Focus mode is set on  (Macro) or  (Super Macro).	Normal pictures will be out of focus if taken with focus mode set on  (Macro) or  (Super Macro).
Flash does not discharge	Flash mode is set to Off	Set to Auto or  (p.39)
	The Capture mode is set to  , continuous shooting or infinity-landscape mode.	Flash will not discharge in these modes.

# Main Specifications

Type	Fully automatic compact-type digital still camera with built-in zoom lens	
Effective Pixels	4.0 megapixels	
Sensor	4.23 megapixels (total pixels), 1/2.5 inch interline transfer CCD with a primary color filter	
Recorded Pixels	Still	2304×1728 pixels, 1600×1200 pixels, 1024×768 pixels, 640×480 pixels
	Movie picture	320×240 pixels
Sensitivity	Auto, manual (Equivalent to ISO 50, 100, 200)	
File Format	Still	JPEG (Exif2.2), DCF, DPOF, PRINT Image Matching II
	Movie	AVI (Open DML Motion JPEG), approx. 15 fps, with sound
	Sound	WAV (ADPCM system), max. recording time 59 min. 46 sec. (when using a 16 MB SD Memory Card)
Quality Level	"Best", "Better", "Good"	
Storage Medium	Built-in memory (approx. 11 MB), SD Memory Card / MultiMediaCard (MMC)	

## Image Storage Capacity

Recorded Pixels \ Quality Level	Best (★★★)	Better (★★)	Good (★)	Movie picture (320×240)
2304×1728	5	9	14	60 sec × 1
1600×1200	11	20	28	
1024×768	26	47	62	
640×480	57	89	119	

- When using a 16MB SD Memory Card

White Balance	Auto, Daylight, Shade, Tungsten Light, Fluorescent light, Manual	
	Lens	
	Focal Length	5.8 mm – 17.4 mm (Equivalent to 35 mm – 105 mm in 35 mm format)
	Maximum Aperture	f/2.6 – f/4.8
	Lens Composition	6 elements in 5 groups (two aspherical elements)
	Zoom type	Electrically driven
	Picture Range	39.5 mm×29.6 mm (screen is filled) (Super Macro mode)
Lens Barrier	Electrically driven	
	Digital Zoom	
Capture Mode	Max 4× (Combines with 3× optical zoom to give zoom magnification equivalent to 12×)	
Viewfinder	Type	Real-image zoom viewfinder
	Magnification	Wide 0.28×, Tele 0.78×
	Diopter	-1 m <sup>-1</sup> (at 3 m)

LCD monitor	1.6 inch TFT color LCD with 84 kilopixels monitor (with backlight)	
Playback Functions	Single-frame, 9-frame index, enlargement (max. 4'), scroll, slideshow, movie playback, histogram display, image/sound copying, trimming, resizing	
Focusing System	Type	TTL contrast detection system by sensor 7-point autofocus (Spot autofocus possible)
	Focusing Range (From lens front)	Normal: 0.4 m to infinity (full zoom range) Macro: 0.18 m – 0.5 m (full zoom range) Super macro: 0.06 m – 0.2 m (middle zoom position only) Landscape: Infinity (full zoom range)
	Focus Lock	By half-pressing shutter release button
Manual Focus	0.06 m to infinity	
Exposure Mechanism	AE Metering	TTL metering by sensor (multi-segment, center-weighted, spot)
	Shooting Modes	Standard, Picture, Night-Scene, Movie, Panorama Assist, 3D, Digital Filter, USER
	EV compensation	±2EV (Can be set in 1/3EV steps)
	Movie	Recording time approx. 1 sec. – 1 min., Fast Fwd Movie: max. approx. 100 min.
Shutter	Type	Electronic/mechanical shutter
	Speed	Approx. 1/2000 sec. - 4 sec.
Flash	Type	Auto flash with red-eye reduction function
	Flash Modes	Auto, Flash Off, Flash On, Auto + Red-eye Reduction, Flash On + Red-eye Reduction
	Working Range	Wide: Approx. 0.2m-3.5m w/sensitivity at 200 Tele: Approx. 0.1m-2.0m w/sensitivity at 200
Drive Modes	Single-frame, Continuous, Remote Control, Self-timer	
Self-timer	Electronic control type, delay time: approx. 10 sec.	
Time function	World Time setting for 62 cities (28 time zones)	
Power Supply	Rechargeable lithium-ion battery D-Li8, AC adapter (optional)	
Battery Life	Approx. 160 images (with LCD monitor on, flash fired for 50% of shots and using a rechargeable lithium-ion battery D-Li8, in accordance with Pentax measuring conditions)	
In/Out Port	USB/AV terminal (PC communication type USB 1.1), external power supply terminal	
Video Output format	NTSC, PAL	
Size	83 (W) × 52 (H) × 20 (D) mm (excluding operating members and projections)	
Mass	98g (excluding battery and SD Memory Card / MultiMediaCard)	
Mass when shooting	113g (including battery and SD Memory Card / MultiMediaCard)	
Accessories	Rechargeable lithium-ion battery, 3D image viewer, USB cable, software (CD-ROM), AV cable, strap, operating manual	

# WARRANTY POLICY

All Pentax cameras purchased through authorized bona fide photographic distribution channels are guaranteed against defects of material or workmanship for a period of twelve months from date of purchase. Service will be rendered, and defective parts will be replaced without cost to you within that period, provided the equipment does not show evidence of impact, sand or liquid damage, mishandling, tampering, battery or chemical corrosion, operation contrary to operating instructions, or modification by an unauthorized repair shop. The manufacturer or its authorized representatives shall not be liable for any repair or alterations except those made with its written consent and shall not be liable for damages from delay or loss of use or from other indirect or consequential damages of any kind, whether caused by defective material or workmanship or otherwise; and it is expressly agreed that the liability of the manufacturer or its representatives under all guarantees or warranties, whether expressed or implied, is strictly limited to the replacement of parts as hereinbefore provided. No refunds will be made on repairs by non-authorized Pentax service facilities.

## Procedure During 12-month Warranty Period

Any Pentax which proves defective during the 12-month warranty period should be returned to the dealer from whom you purchased the equipment or to the manufacturer. If there is no representatives of the manufacturer in your country, send the equipment to the manufacturer, with postage prepaid. In this case, it will take a considerable length of time before the equipment can be returned to you owing to the complicated customs procedures required. If the equipment is covered by warranty, repairs will be made and parts replaced free of charge, and the equipment will be returned to you upon completion of servicing. If the equipment is not covered by warranty, regular charges of the manufacturer or of its representatives will apply. Shipping charges are to be borne by the owner. If your Pentax was purchased outside of the country where you wish to have it serviced during the warranty period, regular handling and servicing fees may be charged by the manufacturer's representatives in that country. Notwithstanding this, your Pentax returned to the manufacturer will be serviced free of charge according to this procedure and warranty policy. In any case, however, shipping charges and customs clearance fees to be borne by the sender. To prove the date of your purchase when required, please keep the receipt or bills covering the purchase of your equipment for at least a year. Before sending your equipment for servicing, please make sure that you are sending it to the manufacturer's authorized representatives or their approved repair shops, unless you are sending it directly to the manufacturer. Always obtain a quotation for the service charge, and only after you accept the quoted service charge, instruct the service station to proceed with the servicing.



- This warranty policy does not affect the customer's statutory rights.
- The local warranty policies available from Pentax distributors in some countries can supersede this warranty policy. Therefore, we recommend that you review the warranty card supplied with your product at the time of purchase, or contact the PENTAX distributor in your country for more information and to receive a copy of the warranty policy.



The CE Mark is a Directive conformity mark of the European Community.

## For customers in USA

### STATEMENT OF FCC COMPLIANCE

This device complies with Part 15 of the FCC Rules. Operation is subject to the following two conditions: (1) This device may not cause harmful interference, and (2) this device must accept any interference received, including interference that may cause undesired operation.

Changes or modifications not approved by the party responsible for compliance could void the user's authority to operate the equipment.

This equipment has been tested and found comply with the limits for a Class B digital device, pursuant to part 15 of the FCC Rules.

These limits are designed to provide reasonable protection against harmful interference in a residential installation. This equipment generates, uses and can radiate frequency energy and, if not installed and used in accordance with the instructions, may cause harmful interference to radio communications. However, there is no guarantee that interference will not occur in a particular installation.

If this equipment does cause harmful interference to radio or television reception, which can be determined by turning the equipment off and on, the user is encouraged to try to correct the interference by one or more of the following measures:

- Reorient or relocate the receiving antenna.  
Increase the separation between the equipment and receiver.  
Connect the equipment into an outlet on a circuit different from that to which the receiver is connected.
- \* Consult the dealer or an experienced radio/TV technician for help.

## For customers in Canada

This Class B digital apparatus meets all requirements of the Canadian Interference - Causing Equipment Regulations.

## Pour les utilisateurs au Canada

Cet appareil numérique de la classe B respecte toutes les exigences du Règlement sur le matériel brouilleur du Canada.

**Declaration of Conformity**  
According to 47CFR, Parts 2 and 15 for  
**Class B Personal Computers and Peripherals**

We: PENTAX U.S.A., Inc.

Located at: 600 12<sup>th</sup> Street, Suite 300  
Golden, Colorado 80401 U.S.A.  
Phone: 303-799-8000 FAX: 303-790-1131

Declare under sole responsibility that the product identified herein, complies with 47CFR Parts 2 and 15 of the FCC rules as a Class B digital device. Each product marketed, is identical to the representative unit tested and found to be compliant with the standards. Records maintained continue to reflect the equipment being produced can be expected to be within the variation accepted, due to quantity production and testing on the statistical basis as required by 47CFR 2.909. Operation is subject to the following two conditions: (1) This device may not cause harmful interference, and (2) This device must accept any interference received, including interference that may cause undesired operation. The above named party is responsible for ensuring that the equipment complies with the standards of 47CFR §15.101 to §15.109.

Product Name: PENTAX Digital Still Camera

Model Number: Optio S4

Contact person: Customer Service Manager

Date and Place: August, 2003, Colorado

<b>PENTAX Corporation</b>	2-36-9, Maeno-cho, Itabashi-ku, Tokyo 174-8639, JAPAN ( <a href="http://www.pentax.co.jp/">http://www.pentax.co.jp/</a> )
<b>PENTAX Europe GmbH (European Headquarters)</b>	Julius-Vosseler-Strasse, 104, 22527 Hamburg, GERMANY (HQ - <a href="http://www.pentaxeurope.com">http://www.pentaxeurope.com</a> ) (Germany - <a href="http://www.pentax.de">http://www.pentax.de</a> )
<b>PENTAX U.K. Limited</b>	PENTAX House, Heron Drive, Langley, Slough, Berks SL3 8PN, U.K. ( <a href="http://www.pentax.co.uk">http://www.pentax.co.uk</a> )
<b>PENTAX France S.A.S.</b>	12/14, rue Jean Poulmarch, 95106 Argenteuil Cedex, FRANCE
<b>PENTAX Benelux B.V.</b>	(for Netherlands) Spinveld 25, 4815 HR Breda, NETHERLANDS ( <a href="http://www.pentax.nl">http://www.pentax.nl</a> ) (for Belgium & Luxembourg) Weiveldlaan 3-5, 1930 Zaventem, BELGIUM ( <a href="http://www.pentax.be">http://www.pentax.be</a> )
<b>PENTAX (Schweiz) AG</b>	Widenholzstrasse 1 Postfach 367 8305 Dietlikon, SWITZERLAND ( <a href="http://www.pentax.ch">http://www.pentax.ch</a> )
<b>PENTAX Scandinavia AB</b>	P.O. Box 650, 75127 Uppsala, SWEDEN ( <a href="http://www.pentax.se">http://www.pentax.se</a> )
<b>PENTAX U.S.A., Inc</b>	600 12 <sup>th</sup> Street, Suite 300 Golden, Colorado 80401, U.S.A. ( <a href="http://www.pentax.com">http://www.pentax.com</a> )
<b>PENTAX Canada Inc.</b>	3131 Universal Drive, Mississauga, Ontario L4X 2E5, CANADA ( <a href="http://www.pentaxcanada.ca">http://www.pentaxcanada.ca</a> )



for your  
precious moments

- Printed on recycled paper
- Specifications and external dimensions are subject to change without notice.

57335

Copyright © PENTAX Corporation 2003  
01-200308 Printed in Japan

## Free Manuals Download Website

<http://myh66.com>

<http://usermanuals.us>

<http://www.somanuals.com>

<http://www.4manuals.cc>

<http://www.manual-lib.com>

<http://www.404manual.com>

<http://www.luxmanual.com>

<http://aubethermostatmanual.com>

Golf course search by state

<http://golfingnear.com>

Email search by domain

<http://emailbydomain.com>

Auto manuals search

<http://auto.somanuals.com>

TV manuals search

<http://tv.somanuals.com>