

RICOH

Digital Camera

PENTAX Q-S1

Start Guide

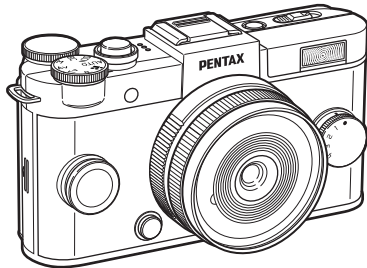

Thank you for purchasing the PENTAX Q-S1 digital camera.

This Start Guide provides information on how to get your PENTAX Q-S1 ready for use and its basic operations. To ensure proper operation, please read this Start Guide before using the camera.

For details on how to use the various shooting methods and settings, please refer to the Operating Manual (PDF) posted on our website.

Refer to p.48 for details on the Operating Manual.

Checking the Contents of the Package



Hot shoe cover Fk
(Installed on camera)



Q body mount cover
(Installed on camera)

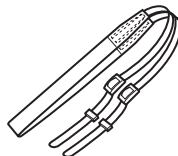

Strap
O-ST131

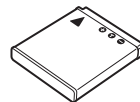

Rechargeable lithium-ion
battery D-LI68

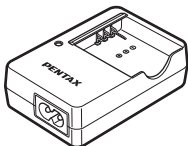

Battery charger
D-BC68P



AC plug cord

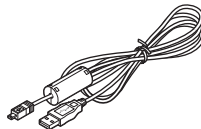

USB cable
I-USB7

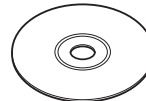

Software (CD-ROM)
S-SW151

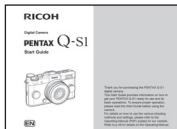

Start Guide (this manual)

Lenses that can be used with the PENTAX Q-S1

Lenses that can be used with the camera are Q-mount lenses. A K-mount lens can be attached to the camera with the use of the optional Adapter Q for K Mount Lens. (p.30)

Download from [Www.Somanuals.com](http://www.Somanuals.com). All Manuals Search And Download.

Contents

Names and Functions of the Working Parts	3
Operating Controls	4
Monitor Display	5
How to Change Function Settings	8
Using the Direct Keys	8
Using the Control Panel	8
Using the Menus	9
Menu List	10
Rec. Mode Menus	10
Movie Menu	12
Playback Menu	12
Set-up Menu	13
Custom Setting Menus	15
Getting Your Camera Ready for Use	16
Attaching the Strap	16
Attaching a Lens	16
Using the Battery and Charger	17
Inserting a Memory Card	18
Initial Settings	18
Formatting a Memory Card	19
Basic Shooting Operation	20
Capture Mode Types	21
Shooting with Smart Effect	24
Reviewing Images	25
Playback Mode Palette	26

Restrictions on Each Capture Mode	27
Restrictions on the Combinations of Special Functions	29
Functions Available with Various Lenses	30
Using a K-Mount Lens	31
Main Specifications	32
Operating Environment for USB Connection and Provided Software	36
For Using Your Camera Safely	37
Care to be Taken During Handling	39
WARRANTY POLICY	42
Information on the Operating Manual	48

There is a possibility that the illustrations and the display screen of the monitor in this manual are different from the actual ones.

Regarding copyrights

Images taken with this camera that are for anything other than personal enjoyment cannot be used without permission according to the rights as specified in the Copyright Act. Please take care, as there are cases where limitations are placed on taking pictures even for personal enjoyment during demonstrations, performances or of items on display. Images taken with the purpose of obtaining copyrights also cannot be used outside the scope of use of the copyright as laid out in the Copyright Act, and care should be taken here also.

To users of this camera

- Do not use or store this camera in the vicinity of equipment that generates strong electromagnetic radiation or magnetic fields. Strong static charges or the magnetic fields produced by equipment such as radio transmitters could interfere with the monitor, damage the stored data, or affect the camera's internal circuitry and cause camera misoperation.
- The liquid crystal panel used for the monitor is manufactured using extremely high precision technology. Although the level of functioning pixels is 99.99% or better, you should be aware that 0.01% or fewer of the pixels may not illuminate or may illuminate when they should not. However, this has no effect on the recorded image.
- In this manual, the generic term "computer(s)" refers to either a Windows PC or a Macintosh.
- In this manual, the term "battery(ies)" refers to any type of batteries used for this camera and its accessories.

Regarding User Registration

In order to better serve you, we request that you complete the user registration, which can be found on the CD-ROM supplied with the camera or on our website. Thank you for your cooperation.

<http://www.ricoh-imaging.com/registration/>

Names and Functions of the Working Parts

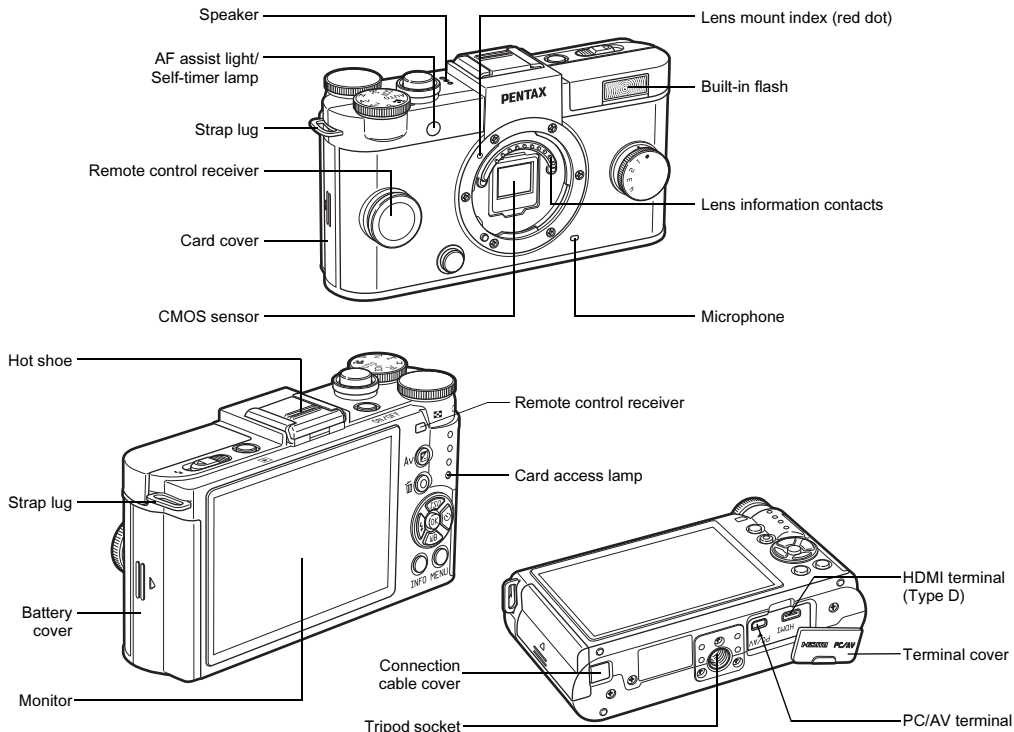

Operating Controls

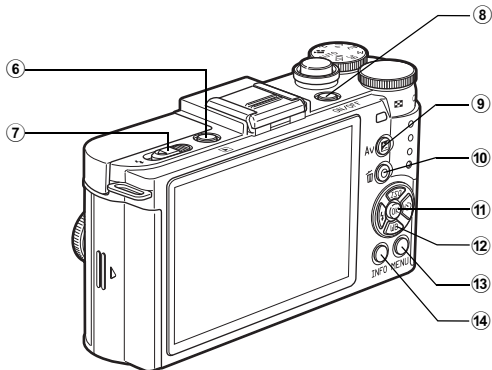
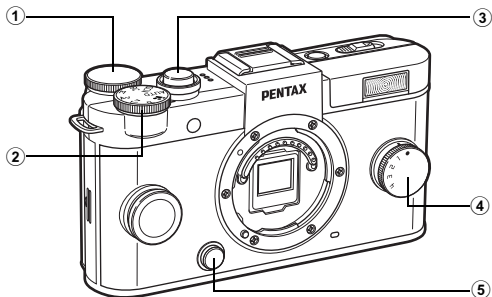

① E-dial (☉)

Sets the shutter speed, aperture, and exposure compensation values. (p.23)

You can change the camera settings when the control panel is displayed. (p.8)

You can change the menu tabs when a menu screen is displayed. (p.9)

In playback mode, use this to magnify an image or display multiple images at the same time.

② Mode dial

Changes the capture mode. (p.20)

③ Shutter release button

Press to capture images. (p.20)

In playback mode, press halfway to switch to capture mode.

④ Quick dial

You can easily retrieve functions such as those assigned with Smart Effect. (p.24)

⑤ Lens unlock button

Press to detach the lens on the camera. (p.16)

⑥ Playback button (⏮)

Switches to playback mode. (p.25) Press the button again to switch to capture mode.

⑦ Flash pop-up switch

Slide to pop up the built-in flash.

⑧ Power switch

Press to turn the camera on and off.

⑨ EV compensation button (☉)

Press to change the exposure compensation and aperture values. (p.23)

In playback mode, the JPEG data remaining in the buffer memory is saved in RAW format.

⑩ **Green/Delete button (O/📷)**

Resets the values being adjusted. Also, you can assign a function to this button.

Press to delete images during playback. (p.25)

⑪ **OK button (OK)**

When the control panel or a menu is displayed, press this button to confirm the selected item.

⑫ **Four-way controller (▲▼◀▶)**

Displays the Sensitivity, White Balance, Flash Mode or Drive Mode setup menu. (p.8)

When the control panel or a menu is displayed, use this to move the cursor or change the item to set.

Press ▼ during playback to display the playback mode palette. (p.26)

⑬ **MENU button (MENU)**

Displays a menu. Press this button while the menu is displayed to return to the previous screen. (p.9)

⑭ **INFO button (INFO)**

Changes the style of the display on the monitor. (p.5, p.7)

About the four-way controller

In this manual, each button of the four-way controller is indicated as shown in the illustration on the right.

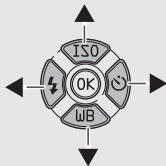

Monitor Display

Capture Mode

When the camera enters capture mode, the subject and the current shooting function settings are displayed on the monitor. This state is referred to as “standby mode”. Press **INFO** in standby mode to display the “control panel” and change settings. (p.8) If you press **INFO** while the control panel is displayed, you can change the type of information displayed in standby mode.



Standby mode
(Standard Information Display)

Control panel



Shooting Info Display
selection screen

Standby Mode

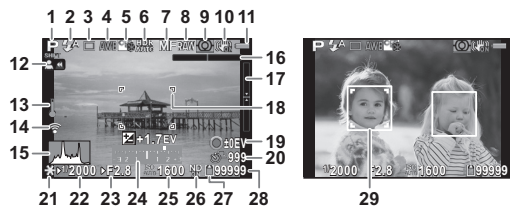

- | | |
|---------------------------|---------------------------|
| 1 Capture mode | 17 Electronic Level |
| 2 Flash Mode | (vertical) |
| 3 Drive Mode | 18 AF frame |
| 4 White Balance | 19 Reset exposure |
| 5 Custom Image | compensation value |
| 6 HDR Capture/Digital | 20 Interval Shooting/ |
| Filter | Multi-exposure/ |
| 7 MF mode | Smart Effect |
| 8 File Format | 21 AE Lock |
| 9 AE Metering | 22 Shutter speed |
| 10 Shake Reduction/ | 23 Aperture value |
| Movie SR | 24 EV bar scale |
| 11 Battery level | 25 Sensitivity |
| 12 Turning the focus ring | 26 ND Filter |
| in MF mode | 27 Memory card |
| 13 Temperature warning | 28 Image storage capacity |
| 14 Eye-Fi communication | 29 Face detection frame |
| status | (when [Autofocus |
| 15 Histogram | Method] is set to [Face |
| 16 Electronic Level | Detection]) |
| (horizontal) | |

Control Panel

mode

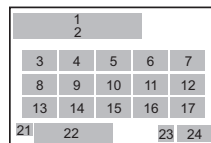

mode

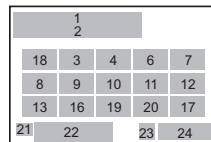

- | | |
|----------------------------|--------------------------|
| 1 Function name | 15 File Format |
| 2 Setting | 16 JPEG Recorded Pixels |
| 3 Custom Image/ SCN | and Quality Level/Movie |
| mode | Recorded Pixels |
| 4 Digital Filter | 17 Shake Reduction/ |
| 5 HDR Capture | Movie SR |
| 6 Highlight Correction | 18 Exposure Setting |
| 7 Shadow Correction | 19 Framerate |
| 8 AE Metering | 20 Recording Sound Level |
| 9 ND Filter | 21 Destination |
| 10 Focus Method | 22 Current date and time |
| 11 Autofocus Method | 23 Memory card |
| 12 Focus Peaking | 24 Number of recordable |
| 13 Distortion Correction | still pictures/movie |
| 14 Aspect Ratio | recordable time |

Playback Mode

The captured image and shooting information are displayed in single image display of the playback mode.

Press **INFO** to change the type of information displayed in single image display. Use **◀▶** to select the type and press **OK**.



Single image display
(Standard Information Display)



Playback Info Display
selection screen

How to Change Function Settings

The camera functions and their settings can be selected and changed by using the following ways.

Direct keys	Press ▲▼◀▶ in standby mode.
Control panel	Press INFO in standby mode. (indicated with the  icon in this manual)
Menus	Press MENU .

Using the Direct Keys

▲	Sensitivity
▼	White Balance
◀	Flash Mode
▶	Drive Mode

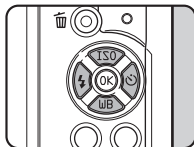

Using the Control Panel

INFO

You can set frequently used shooting functions. Press **INFO** in standby mode.

Use ▲▼◀▶ to select an item.

Use  to change settings.

Press **MENU** to cancel setting operation.



Press **OK** to confirm the selected item and return to the control panel.

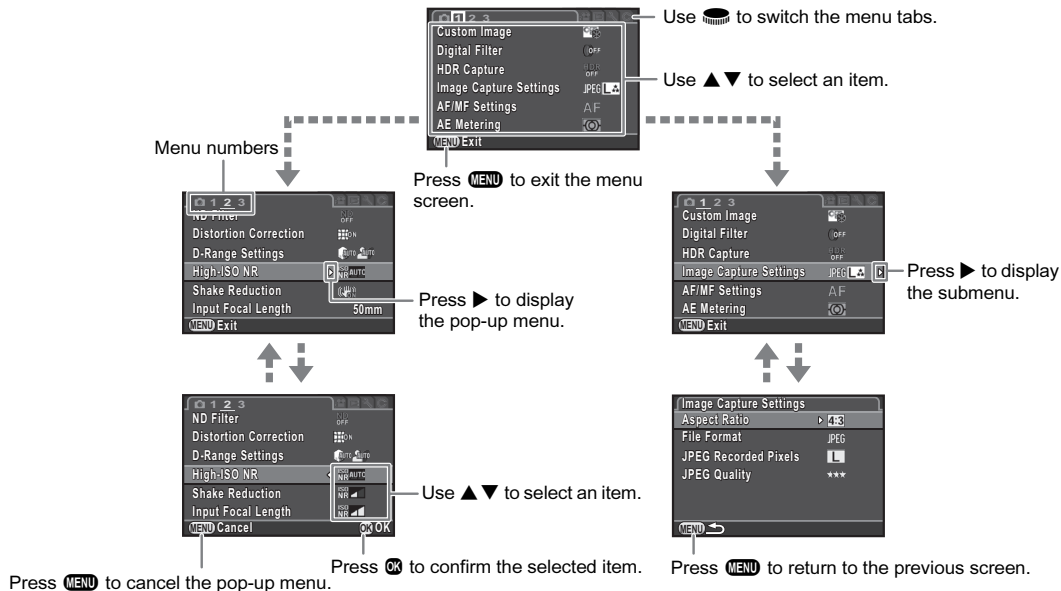



Most functions are set from the menu. Functions that can be set on the control panel can also be set from the menus.



Menu List



Rec. Mode Menus

Menu	Item	Function	Default Setting	
	Custom Image *1	Sets the image finishing tone such as color and contrast before shooting an image.	Bright	
	Digital Filter *1	Applies a digital filter effect when taking pictures.	No Filter	
	HDR Capture *1	Enables capturing images with high dynamic range.	Off	
	Image Capture Settings	Aspect Ratio *1	Sets the horizontal and vertical ratio of images.	4:3
		File Format *1	Sets the file format of images.	JPEG
		JPEG Recorded Pixels *1	Sets the recording size of images saved in JPEG format.	L
		JPEG Quality *1	Sets the quality of images saved in JPEG format.	★★★
	AF/MF Settings	Focus Method *1	Selects the autofocus or manual focus mode.	AF
		Autofocus Method *1	Selects the autofocus method in AF mode.	Multiple AF Points
		AF Assist Light	Sets whether to use the assist light when autofocusing in dark locations.	On
		MF Autozoom	Magnifies the monitor display and makes it easier to focus on the subject.	Off
Focus Peaking *1		Emphasizes the outline of the subject in focus and makes it easier to check the focus.	Off	
AE Metering *1	Selects the part of the sensor to use for measuring brightness and determining exposure.	Multi-segment		
	ND Filter *1	Sets whether to use the ND filter built-in to the lens.	Off	
	Distortion Correction *1	Reduces distortions occurring due to lens properties.	On	

Menu	Item		Function	Default Setting
	D-Range Settings	Highlight Correction *1	Expands the dynamic range and prevents bright areas from occurring.	Auto
		Shadow Correction *1	Expands the dynamic range and prevents dark areas from occurring.	Auto
	High-ISO NR		Sets the Noise Reduction setting when shooting with a high ISO sensitivity.	Auto
	Shake Reduction *1		Activates the Shake Reduction function.	On
	Input Focal Length		Sets the focal length when using a lens for which focal length information cannot be obtained.	0.0 mm
	Live View	Electronic Level	Displays the camera angle (horizontal and vertical) in standby mode.	On
		Grid Display	Displays the grid in standby mode.	Off
		Histogram Display	Displays the histogram in standby mode.	Off
		Highlight Alert	Bright (overexposed) areas blink red in standby mode.	Off
	Instant Review	Display Time	Sets the Instant Review display time.	1sec.
		Zoom Instant Review	Sets whether to display magnified image during Instant Review.	Off
		Save RAW Data	Sets whether to save the RAW image during Instant Review.	On
		Delete	Sets whether to delete the displayed image during Instant Review.	On
		Histogram Display	Displays the histogram during Instant Review.	Off
	Highlight Alert	Bright (overexposed) areas blink red during Instant Review.	Off	
	Quick Dial		Assigns functions to the quick dial.	Smart Effect
	Green Button	Green Button	Assigns a function to  .	Green Button
		Action in M/TAv Mode	Sets the camera action for when  is pressed in M / TAv mode.	P LINE
		E-dial in Program	Sets the value to change when  is turned in P mode.	P SHIFT
Memory		Determines which settings to save when the power is turned off.	All On except Focus Position, Digital Filter, HDR Capture	



*1 The functions can also be set from the control panel.

Movie Menu

Menu	Item	Function	Default Setting
 1	Exposure Setting *1	Sets whether to adjust the shutter speed and aperture value manually.	Program AE
	Digital Filter *1	Applies a digital filter effect when recording a movie.	No Filter
	Movie Capture Settings *1	Sets the number of recorded pixels and the framerate of the movie.	 /30 fps
	Movie Continuous AF	Continues autofocusing even while recording a movie.	On
	Recording Sound Level *1	Sets the volume level for recording.	Volume level 3
	Movie SR *1	Activates the Movie Shake Reduction function.	On





*1 The functions can also be set from the control panel.

Playback Menu

Menu	Item	Function	Default Setting	
 1	Slideshow	Display Duration	Sets an image display interval.	3sec.
		Screen Effect	Sets a transition effect when the next image is displayed.	Off
		Repeat Playback	Starts the slideshow again from the beginning after the last image is displayed.	Off
		Auto Movie Playback	Plays back movies during the slideshow.	On
 1	Quick Zoom	Sets the initial magnification when magnifying images.	Off	
	Highlight Alert	Bright (overexposed) portions blink red in Standard Information Display or Histogram Display in playback mode.	Off	
	Auto Image Rotation	Rotates images which were captured with the camera held vertically or of which the rotation information has been changed.	On	
	Delete All Images	Deletes all saved images at once.	-	

Set-up Menus

Menu	Item	Function	Default Setting	
1	Language/言語	Changes the display language.	English	
	Date Adjustment	Sets the date and time and the display format.	01/01/2014	
	World Time	Switches the displayed date and time to that of your hometown or a specified city.	Hometown	
	Sound Effects	Switches the operation sound on/off and changes the volume for In-focus, AE-L, Self-timer, Remote Control, One Push File Format and Shutter Sound.	Volume 3 Shutter Sound: 1 Others: On	
	LCD Display	Guide Display	Sets whether to display the operation guides when the capture mode is changed.	On
		Display Color	Sets the display color of the control panel and the menus.	1
	LCD Display Settings	Adjusts the brightness and the color of the monitor.	0	
2	Flicker Reduction	Cuts down on screen flicker by setting the power frequency.	50Hz	
	Interface Options	Video Out	Sets the output format when connecting to an AV device with a video input terminal.	-
		HDMI Out	Sets the output format when connecting to an AV device with an HDMI input terminal.	Auto
		USB Connection	Sets the USB connection mode when connecting to a computer.	MSC
	Folder Name	Sets the naming system for folders to store images.	Date	
	Create New Folder	Creates a new folder on the memory card.	-	
	File No.	Sequential Numbering	Sets whether to continue the sequential numbering for the file name even if a new folder is created.	On
		Reset File Number	Resets the file number and starts numbering from 0001 again.	-
	Eye-Fi	Sets the camera action for when an Eye-Fi card is used.	Off	

Menu	Item	Function	Default Setting
3	Power Saving	Enables saving battery power by setting the monitor display to dim automatically if no operations are made within 5 seconds.	On
	Auto Power Off	Sets the time until the camera turns off automatically if no operations are made for a certain period of time.	1min.
	Reset	Resets the settings of the direct keys and for the items of the  menu,  menu,  menu,  menu, control panel, and playback mode palette.	-
4	Pixel Mapping	Maps out and corrects any defective pixels on the CMOS sensor.	-
	Dust Removal	Cleans the CMOS sensor by shaking it.	-
	Format	Formats a memory card.	-
	Firmware Info/Options	Displays the camera's firmware version.	-

Custom Setting Menus

Menu	Item	Function	Default Setting
C1	1. Lens Shutter Options	Sets whether to use the lens shutter and/or the electronic shutter.	Lens shutter only
	2. Sensitivity Steps	Sets the adjustment steps for ISO sensitivity.	1 EV Step
	3. AE-L with AF Locked	Sets whether to lock the exposure value when the focus is locked.	Off
	4. Link AE and AF Point	Sets whether to link the exposure and AF point in the focusing area during multi-segment metering.	Off
	5. Bracketing Order	Sets the order for Exposure Bracketing shooting.	0 - +
	6. WB When Using Flash	Sets the white balance setting when using flash.	Auto White Balance
C2	7. AWB in Tungsten Light	Sets the tungsten light color tone when the white balance is set to AWB (Auto White Balance).	Subtle Correction
	8. AF Release Options	Sets the action priority for when the shutter release button is fully pressed in AF mode.	Focus-priority
	9. AF with Remote Control	Sets whether to use autofocus when shooting with a remote control unit.	Off
	10. Focus Ring in AF Mode	Disables the focus ring operation during AF mode.	Enable
	11. Flash When Retracted	Sets whether to discharge the built-in flash when retracted.	Discharge Flash
	12. Release While Charging	Sets whether to release the shutter while the built-in flash is charging.	Off
C3	13. Color Space	Sets the color space to use.	sRGB
	14. Save Rotation Info	Sets whether to save rotation information when shooting.	On
	15. Save Menu Location	Saves the last menu tab displayed on the monitor and displays it again the next time MENU is pressed.	Reset Menu Location
	16. Auto SR Off	Automatically turns off the Shake Reduction function when Self-timer or Remote Control is set.	Enable Auto SR Off
	Reset Custom Functions	Resets all the settings in the C 1-3 menus to the defaults.	-

Getting Your Camera Ready for Use

Attaching the Strap

- 1 Pass the end of the strap through the strap lug and secure it on the inside of the clasp.

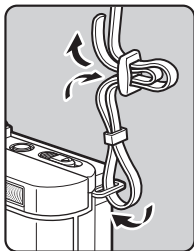

- 2 Attach the other end in the same manner.

Attaching a Lens

- 1 Make sure that the camera is turned off.
- 2 Remove the body mount cover (1) and lens mount cover (2).
After removing the cover, be sure to put the lens down with the lens mount side facing upward.
- 3 Align the lens mount index (red dots: 3) on the camera and the lens, and secure by turning the lens clockwise until it clicks.

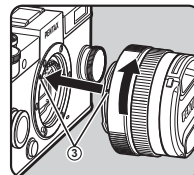
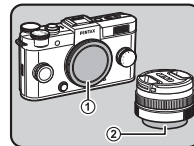

To remove the lens

Attach the lens cap, and then turn the lens counterclockwise while holding down the lens unlock button (4).

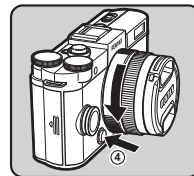

Using the Battery and Charger

Charging the Battery

- 1 Connect the AC plug cord to the battery charger.
- 2 Plug the AC plug cord into the power outlet.

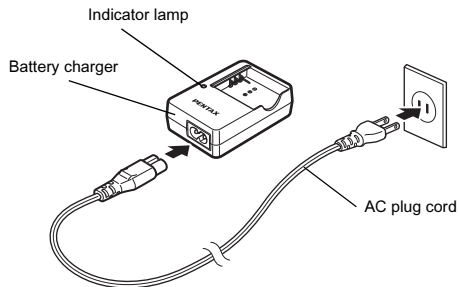

- 3 Face the ▲ mark on the battery up, and insert it into the battery charger.

The indicator lamp is lit while charging and turns off when the battery is fully charged.
(Approximate maximum charging time: 115 minutes)

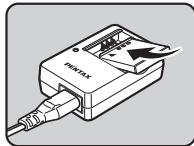

Inserting/Removing the Battery

- 1 Slide the battery cover in the direction of ①.

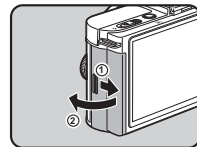

- 2 Insert the battery until it locks into place with the ▲ mark facing toward the lens.

To remove the battery, push the battery lock lever in the direction of ③.

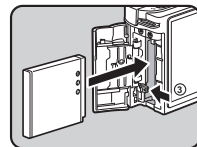

- 3 Close the battery cover, and slide it in the direction of ⑤.

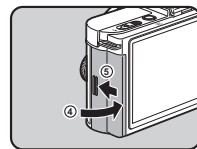

Inserting a Memory Card

- 1 Slide the card cover in the direction of ①.

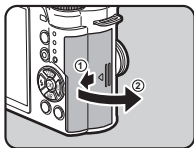

- 2 Insert the card all the way with the memory card label facing toward the monitor. Push the memory card in once to remove.

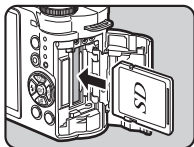

- 3 Close the card cover, and slide it in the direction of ④.

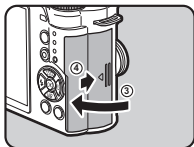

Initial Settings

- 1 Press the power switch. The [Language/言語] screen appears.

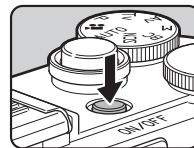

- 2 Use ▲▼◀▶ to select the desired language and press OK.

The [Initial Setting] screen appears in the selected language. Proceed to Step 7 if ⏏ (Hometown) does not need to be changed.



- 3 Press ▼ to move the frame to ⏏ and press ▶.
- The [⏏ Hometown] screen appears.

- 4 Use ◀▶ to select a city. Use ⏏ to change the region.



- 5 Press ▼ to select [DST] (daylight saving time), and use ◀▶ to select or .

- 6 Press OK.

The camera returns to the [Initial Setting] screen.

- 7** Press **▼** to select **[Settings complete]** and press **OK**.
The [Date Adjustment] screen appears.



- 8** Press **▶**, and use **▲▼** to select the date format.

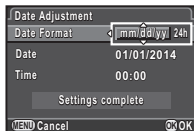

- 9** Press **▶**, and use **▲▼** to select 24h or 12h.

- 10** Press **OK**.

The frame returns to [Date Format].

- 11** Press **▼**, and then press **▶**.

The frame moves to the month if the date format is set to [mm/dd/yy].

- 12** Use **▲▼** to set the month.

Set the day, year and time in the same manner.

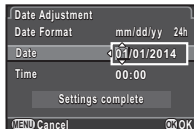

- 13** Press **▼** to select **[Settings complete]** and press **OK**.

The camera switches to capture mode and is ready to take a picture.

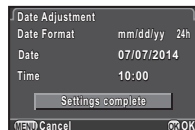

Formatting a Memory Card



- 1** Press **MENU**.

The **1** menu appears.

- 2** Use **⊙** to display **4** menu.

- 3** Use **▲▼** to select **[Format]** and press **▶**.

The [Format] screen appears.

- 4** Press **▲** to select **[Format]** and press **OK**.

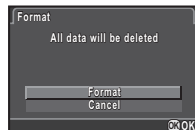

Basic Shooting Operation

- 1** Remove the front lens cap by pushing the top and bottom portions as indicated in the illustration.

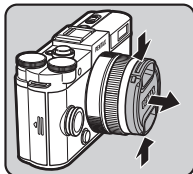

- 2** Turn the mode dial to select the capture mode.



Dial indicator

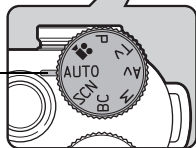

The selected capture mode is displayed on the monitor (Guide Display).



- 3** View the subject on the monitor.

- 4** When using a zoom lens, turn the zoom ring to the right or left to adjust the composition of the image.

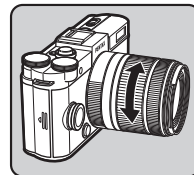

- 5** Position the subject inside the AF frame and press the shutter release button halfway.

Focus on the subject.





AF frame

- 6** Press the shutter release button fully.

The captured image is displayed on the monitor (Instant Review).

Available operations

- | | |
|---|----------------------|
|  | Deletes the image. |
|  | Saves the RAW image. |

Capture Mode Types

Select the capture mode that suits the subject and shooting conditions.

The following capture modes are available on this camera.

Capture Mode	Application
AUTO (Auto Picture modes)	Automatically selects the optimal capture mode from (Standard), (Portrait), (Landscape), (Macro), (Night Scene Portrait), (Sunset), (Blue Sky) or (Forest).
SCN (Scene modes)	Offers you various scene modes to choose from.
BC (Blur Control mode)	Enables you to create a picture that looks as if it was taken with a wide-open aperture and shallow depth of field, by shooting multiple images with different focus positions and merging them into a single image.
P/Tv/Av/M (Exposure modes)	Changes the shutter speed and aperture value.
 (Movie mode)	Records a movie.

Memo

- The functions that can be set vary depending on the capture mode. Refer to "Restrictions on Each Capture Mode" (p.27) for details.

Scene Modes











1 Set the mode dial to SCN.

The Scene mode selection screen appears.

2 Use to select a scene mode.



	Portrait	For capturing portraits. Reproduces a healthy and bright skin tone.
	Landscape	For capturing landscape views. Reproduces the vivid green of trees.
	Macro	For capturing tiny objects at close focus range like flowers, coins, jewelry, and more.
	Moving Object	For capturing images of fast moving subjects.
	Night Scene Portrait	For capturing images of people in low light conditions, such as dusk or at night.
	Sunset	For capturing sunrises or sunsets in beautiful, vivid color.
	Blue Sky	For capturing images of blue sky. Produces a more impressive deep blue.
	Forest	Enhances colors of trees and sunbeams through foliage and produces a vivid color image.
	Night Scene	Used for shooting at night.
	Night Scene HDR	Takes three consecutive images at three different exposure levels to create a single composite image with them.
	Night Snap	For taking snapshots in poorly lit place.

 HDR	Captures 3 images to generate a single HDR image and provides a wider dynamic range.
 Quick Macro	For quick capture of tiny objects at close focus range.
 Food	For capturing images of food. Saturation will be rather high to make food look appetizing.
 Pet	For capturing moving pets.
 Kids	For capturing moving kids. Reproduces healthy and bright skin tone.
 Surf & Snow	For capturing images of dazzling backgrounds, such as snowy mountains.
 Backlight Silhouette	Produces a silhouette image of subject in backlight condition.
 Candlelight	For capturing scenes in candlelight.
 Stage Lighting	For capturing moving subjects in poorly lit place.
 Museum	For capturing images in places where a flash is prohibited.

3 Press **OK**.

Memo

- You can change the scene mode from the control panel or the  1 menu.

Blur Control Mode

1 Set the mode dial to BC.



2 Use  to adjust the level of blur.
Check the blur effect in the image by viewing it in playback mode.



Exposure Modes

✓: Available #: Restricted ✕: Not available

Mode	Change Shutter Speed	Change Aperture Value	Change Sensitivity	EV Compensation
P Program Automatic Exposure	# *1	# *1	✓	✓
Tv Shutter Priority Automatic Exposure	✓	✕	✓	✓
Av Aperture Priority Automatic Exposure	✕	✓	✓	✓
M Manual Exposure	✓	✓	✓ *2	✕

*1 You can set the value to be changed in [Green Button] of the  menu.

*2 When the sensitivity is set to [ISO AUTO], the camera operates in **TA**v (Shutter & Aperture Priority Automatic Exposure) mode.

1 Set the mode dial to **P**, **Tv**, **Av** or **M**.

▶ appears next to the value that can be changed.



2 Use to adjust the value.

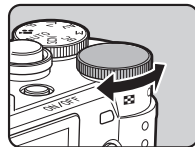

3 In **M** mode, press (1), and use (2) to change the aperture value.

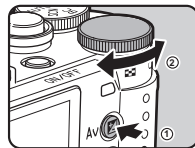

In **P/Tv/Av** mode, the exposure compensation value can be adjusted (from -3 to +3 EV in increments of 1/3 EV) by the same operation.



EV bar scale

Movie Mode

- 1 Set the mode dial to .

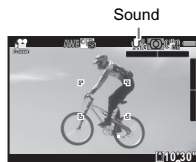

Recordable Time

- 2 Press the shutter release button halfway.

When [Focus Method] is set to **AF**, autofocus is performed.

- 3 Press the shutter release button fully.

Movie recording starts.

● blinks at the top left of the screen.

When [Focus Method] is set to **AF**, press **OK** to perform autofocus.

- 4 Press the shutter release button fully.

Movie recording stops.

Shooting with Smart Effect

You can take images using various effects.
The following effects are available.

Brilliant Color
Unicolor Bold
Vintage Color
Antique
Warm Fade

Tone Expansion
Bold Monochrome
Vibrant Color Enhance
Faded Color
USER 1 to 3

- 1 In standby mode, turn the quick dial to select the position 1 to 4.

With the default settings, Brilliant Color, Unicolor Bold, Vintage Color, and Antique can be selected.

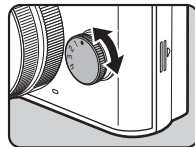

- 2 Shoot.

- 3 After taking pictures, return the quick dial to the position 0.

The camera returns to the original settings.

Memo

- To use effects other than Brilliant Color, Unicolor Bold, Vintage Color, and Antique, the settings of the quick dial must be changed. For details on how to change the settings, refer to the Operating Manual.

Reviewing Images





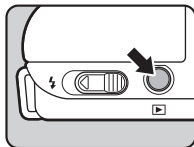







1 Press .

The camera enters playback mode and the most recently captured image is displayed (single image display).



2 Review the captured image.









Available operations

	Displays the previous image.
	Displays the next image.
	Deletes the image.
 to the right	Magnifies the image (up to 16×). Use     to change the area to display. Press  to return the display area to the center.
 to the left	Switches to the thumbnail display.
	Saves the RAW image (only when a JPEG image was taken and the data remains in the buffer).
	Changes the type of information displayed.
	Displays the playback mode palette.

Playing Back Movies



Available operations









	Plays back/pauses a movie.
	Forwards a frame (when paused).
Press and hold 	Fast-forwards playback.
	Reverses a frame (when paused).
Press and hold 	Fast-reverses playback.
	Stops playback.
	Adjusts the volume (6 levels).
	Saves the displayed frame as a JPEG file (when paused).





Playback Mode Palette

Playback functions can be set from the playback mode palette as well as the 1 menu.

You can edit images with the playback mode palette.



Item	Function
 Image Rotation *1	Changes the rotation information of images.
 Digital Filter *1	Processes images with digital filters.
 Red-eye Edit *1 *2	Corrects images of a subject captured with red eyes.
 Resize *1 *2	Changes the number of recorded pixels of the image.
 Cropping *1 *2	Crops out only the desired area of an image.
 Index	Joins a number of images together and creates an index image with them.
 Protect	Protects images from being accidentally erased.
 Slideshow	Plays back images one after another.
 Save as Manual WB *1	Saves the white balance settings of the captured image as Manual White Balance.

Item	Function
 Save Cross Processing	Saves the settings used for an image captured in Cross Processing mode of Custom Image or Smart Effect as your "Favorite" settings.
 Save Smart Effect *1	Saves the shooting settings of your favorite image to the quick dial.
 RAW Development *3	Develops RAW images into JPEG format.
 Movie Edit *4	Divides a movie or deletes unwanted segments.
 Eye-Fi Image Transfer	Transfers selected images wirelessly using an optional Eye-Fi card.

*1 Not available when a movie is displayed.

*2 Not available when a RAW image is displayed.

*3 Available only when a RAW image is saved.

*4 Available only when a movie is displayed.

Restrictions on Each Capture Mode

#: Restricted x: Not available

Capture Mode		SCN											BC	Bulb			
		AUTO															
Function		AUTO ^{*1}				AUTO ^{*1}	x	AUTO ^{*1}	AUTO ^{*1}	AUTO ^{*1}	AUTO ^{*1}	AUTO ^{*1}	AUTO ^{*1}		- ISO 1600		
Sensitivity		AUTO ^{*1}	AUTO ^{*1}	AUTO ^{*1}	AUTO ^{*1}	AUTO ^{*1}	x	AUTO ^{*1}	AUTO ^{*1}	AUTO ^{*1}	AUTO ^{*1}	AUTO ^{*1}	AUTO ^{*1}		- ISO 1600		
Flash		⁺²	⁺²	x	⁺²	⁺²	x	⁺²	⁺²	x	⁺²	x	x			x	
Drive Mode	Single Frame Shooting					x				x	x					x	
	Continuous Shooting					⁺³	x		x	⁺³	⁺³			x	x	x	
	Self-timer					x				x	x					x	
	Remote Control	0 sec./3 sec.					x				x	x					⁺²
		Continuous Shooting					x	x		x	x	x			x	x	x
	Exposure Bracketing						x	x		x	x	x			x	x	x
	Multi-exposure						x	x		x	x	x			x		x
Interval Shooting						x	# ^{*4}		x	x	x			x	x		
Focus Method		^{*1}	^{*1}			^{*1}		^{*1}		^{*1}	^{*1}	^{*1}				^{*5}	
File Format	RAW/RAW+						x		x					x		x	

Function \ Capture Mode	SCN												BC	Bulb		
	AUTO															
Shake Reduction						x									x	
White Balance	AWB ^{*1}	AWB ^{*1}	AWB ^{*1}	AWB ^{*1}	AWB ^{*1}	AWB ^{*1}	AWB ^{*1}	AWB ^{*1}	AWB ^{*1}	AWB ^{*1}	AWB ^{*1}	AWB ^{*1}				
Custom Image	x	x	x	x	x	x	x	x	x	x	x	x				
Digital Filter						x										
HDR Capture						*6		x						x	x	x
Save RAW Data					x	x			x	x						x

*1 Fixed to; the setting cannot be changed.

*2 Limited to; available settings are limited.

*3 Fixed to; for JPEG, for RAW/RAW+.

*4 The shortest shooting interval is 10 sec.

*5 Focus methods other than and can be selected.

*6 Specific settings are used.

Restrictions on the Combinations of Special Functions

x: Not available

		Continuous Shooting	Exposure Bracketing	Multi-exposure	Interval Shooting	Digital Filter	Smart Effect	HDR Capture
Flash								x
Drive Mode	Continuous Shooting		x	x	x			x
	Self-timer	x	x	x	x			
	Remote Continuous Shooting	x	x	x	x			x
	Exposure Bracketing	x		x	x			x
	Multi-exposure	x	x		x	x	x	x
	Interval Shooting	x	x	x				
File Format	RAW/RAW+	📄*1		x				x
Custom Image							x	
Digital Filter				x			x	x
Smart Effect				x		x		x
Save RAW Data		x	x	x				x

*1 Fixed to; the setting cannot be changed.

Functions Available with Various Lenses

A group	01 STANDARD PRIME 02 STANDARD ZOOM 06 TELEPHOTO ZOOM 08 WIDE ZOOM
B group	04 TOY WIDE 05 TOY TELEPHOTO 07 MOUNT SHIELD
C group	03 FISH-EYE
D group	ADAPTER Q FOR K MOUNT LENS

✓ : Available # : Restricted X : Not available

Function \ Lens Type	A group	B group	C group	D group
AF	✓	X	X	X
MF	✓	✓ ^{*1}	✓	✓
Quick-shift focus	✓	X	X	X
Autofocus Method	✓	X	X	X
MF Autozoom	✓	X	X	X
Aperture control	✓	X	X	# ^{*2}
ND filter on the lens	✓	X	X	X
Shutter on the lens	✓	X	X	✓ ^{*3}
Electronic shutter	✓ ^{*4}	✓	✓	✓ ^{*4}
AUTO/SCN/BC mode	✓	# ^{*5}	# ^{*5}	# ^{*2}
P/Tv/Av mode	✓	# ^{*5}	# ^{*5}	# ^{*2}
M mode	✓	# ^{*5 *6}	# ^{*5 *6}	# ^{*2}
Ⓜ mode	✓	# ^{*5}	# ^{*5}	# ^{*2}
Movie Continuous AF	✓ ^{*7}	X	X	X
P-TTL auto flash	✓ ^{*8}	✓ ^{*9}	# ^{*9 *10}	# ^{*9 *11}

- *1 No focusing mechanism on 07 MOUNT SHIELD
- *2 Set the aperture manually.
- *3 Lens shutter built-in to the adapter used.
- *4 Set [1. Lens Shutter Options] to [Lens and electronic shutters] or [Electronic shutter only] in the **C1** menu. When [Lens and electronic shutters] is selected, you can take pictures at higher speeds with the electronic shutter than with the lens shutter.
Ex.) With a 01 STANDARD lens
Pictures are taken at 1/2000 sec. or slower with the lens shutter and 1/2000 sec. or faster with the electronic shutter.
- *5 Aperture value fixed.
- *6 **Bulb** mode is not available. Allows the use of a slow shutter speed of up to 2 sec.
- *7 06 TELEPHOTO ZOOM lens is not available.
- *8 Built-in flash: 1/2000 sec., external flash: 1/250 sec.
- *9 Flash sync speed is approx. 1/13 sec.
- *10 Light is unevenly distributed.
- *11 Light may be unevenly distributed.

Compatibility with the Built-in Flash

Depending on the lens being used, the use of the built-in flash may be limited.

Lens	Restrictions when using the built-in flash
02 STANDARD ZOOM	If the focal length is less than 6 mm, vignetting may occur at the wide-angle setting.
03 FISH-EYE	The built-in flash is not available due to vignetting.
08 WIDE ZOOM	Light may be unevenly distributed depending on the shooting conditions because the built-in flash does not cover the angle of view of the lens.

About Hoods

When using a hood with a 02 STANDARD ZOOM lens, be sure to use the PH-RBB 40.5mm. If the PH-SBA 40.5mm is used, vignetting may occur at the wide-angle setting.

About Filters

Vignetting will occur at the wide-angle setting if the 100 PL FILTER is used with a 02 STANDARD ZOOM lens.

Using a K-Mount Lens

A K-mount lens can be attached to this camera with the use of the optional Adapter Q for K Mount Lens. When a K-mount lens is used, the focal length must be set manually for some functions such as Shake Reduction, since the focal length cannot be obtained automatically.

1 Turn the camera off.

2 Attach the adapter and lens to the camera, and turn the camera on.

The [Input Focal Length] screen appears.

3 Set the lens focal length.

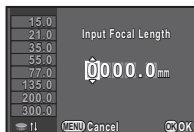

Available operations

- | | |
|----|----------------------------------|
| ▲▼ | Changes the value of each digit. |
| ◀▶ | Selects a digit. |
| 🗲 | Selects a value from the list. |

When using a zoom lens, select the actual focal length which the zoom is set to.

4 Press **OK.**

The camera returns to standby mode.

🗲 Memo

- The focal length setting can be changed in [Input Focal Length] of the **☑2** menu.
- When the Adapter Q for K Mount Lens is used, the camera operates in **Av** mode when the capture mode is set to other than **M** mode.
- Refer to the Adapter Q for K mount lens manual for details.

Main Specifications

Model Description

Type	Lens-interchangeable SL digital camera
Lens Mount	PENTAX bayonet Q-mount
Compatible Lens	Q-mount lenses

Image Capture Unit

Image Sensor	Type: CMOS sensor with a primary color filter Size: 1/1.7-inch
Effective Pixels	Approx. 12.4 megapixels
Total Pixels	Approx. 12.76 megapixels
Dust Removal	Image sensor cleaning using ultrasonic vibrations "DR II"
Sensitivity (Standard output)	AUTO: ISO 100 to ISO 12800 (1/3 EV steps) • Up to ISO 1600 when the shutter speed is set to 2 sec. or slower.
Image Stabilizer	Sensor shift Shake Reduction

File Formats

Recording Formats	RAW (DNG), JPEG (Exif 2.3), DCF 2.0 compliant
Recorded Pixels	<p>JPEG: 4:3 L 12M (4000×3000) M 7M (3072×2304) S 3M (1920×1440) 3:2 L 10M (4000×2664) M 6M (3072×2048) S 2M (1920×1280) 16:9 L 9M (4000×2248) M 5M (3072×1728) S 2M (1920×1080) 1:1 L 9M (2992×2992) M 5M (2304×2304) S 2M (1440×1440)</p> <p>RAW: 4:3 L 12M (4000×3000)</p>

Quality Level	RAW (12 bit): DNG JPEG: ★★★ (Best), ★★ (Better), ★ (Good) • RAW and JPEG simultaneously recordable
Color Space	sRGB, AdobeRGB
Storage Media	SD Memory Cards, SDHC Memory Cards, SDXC Memory Cards and Eye-Fi Cards
Storage Folder	Date (100_1018, 100_1019...)/ PENTX (100PENTX, 101PENTX...)

LCD Monitor

Type	TFT color LCD monitor, wide angle viewing, with AR coating
Size	3.0 inches
Dots	Approx. 460,000 dots
Adjustment	Brightness and colors adjustable
Display	Field of view: approx. 100%, Electronic Level, Grid Display (4 × 4 Grid, Golden Section, Scale), Highlight Alert, Histogram

White Balance

Auto	TTL by CMOS image sensor
Preset	Daylight, Shade, Cloudy, Fluorescent Light (D : Daylight Color, N : Daylight White, W : Cool White, L : Warm White), Tungsten, Flash, CTE , Manual
Manual	Configuration using the display screen (up to 3 settings can be saved), Copying the white balance settings of a captured image
Fine Adjustment	Adjustable ±7 steps on A-B axis and G-M axis

Autofocus System



Type	Contrast detection AF
Brightness Range	EV 0 to 18 (ISO100)
Focus Method	AF/MF switching
Autofocus Method	Face Detection, Tracking, Multiple AF Points, Select, Spot
AF Assist Light	Dedicated LED AF assist light

MF Autozoom	Off/×2/×4/×6
Focus Peaking	Off/On

Exposure Control

Type	TTL image sensor metering Metering modes: Multi-segment metering, Center-weighted metering, and Spot metering
Metering Range	EV 1 to 17 (ISO 100, F1.9 lens), +2 EV with Electronic Shutter enabled, +2 EV with an ND filter
Exposure Modes	Auto Picture modes: Standard, Portrait, Landscape, Macro, Night Scene Portrait, Sunset, Blue Sky, Forest Scene modes: Portrait, Landscape, Macro, Moving Object, Night Scene Portrait, Sunset, Blue Sky, Forest, Night Scene, Night Scene HDR*, Night Snap, HDR*, Quick Macro*, Food, Pet, Kids, Surf & Snow, Backlight Silhouette, Candlelight, Stage Lighting, Museum Program, Shutter Priority, Aperture Priority, Manual, Bulb, Blur Control* *JPEG only
EV Compensation	± 3 EV (1/3 EV steps)
AE Lock	Can be assigned to the  button from the menu.
Shutter	Lens shutter: 1/2000 - 30 seconds (1/3 EV steps, 1/8000 - 30 seconds with Electronic Shutter enabled), Bulb • When using a lens that has no lens shutter, shooting at 1/8000 - 2 seconds with the electronic shutter is available, while Bulb shooting is not available.
Aperture	From wide open to F8 • Aperture is fixed when using a lens that has no lens shutter.
ND Filter	Off/On • Not available when using a lens that has no lens shutter.

Drive Modes

Mode Selection	Single frame, Continuous (Hi, Lo), Self-timer (12s, 2s), Remote Control (0 sec., 3 sec., continuous), Exposure Bracketing (3 frames, remote control), Multi-exposure (0 sec., self-timer, remote control), Interval Shooting
Continuous FPS	Approx. 5 fps, JPEG (4:3  12M/★★★/Continuous Hi): up to 5 frames Approx. 1.5 fps, JPEG (4:3  12M/★★★/Continuous Lo): up to 100 frames

Built-in Flash







Type	Built-in retractable P-TTL flash Guide number: approx. 4.9 (ISO100/m), approx. 7 (ISO200/m) Angle of view coverage: equivalent to 28 mm in 35 mm format
Flash Modes	P-TTL, Red-eye Reduction, Slow-speed Sync, Trailing Curtain Sync
Sync Speed	Lens shutter: built-in flash 1/2000 seconds Used with external flash units: 1/250 seconds Electronic shutter: 1/13 seconds
Flash Exposure Compensation	-2.0 to +1.0 EV

Capture Functions

Custom Image	Bright, Natural, Portrait, Landscape, Vibrant, Radiant, Muted, Bleach Bypass, Reversal Film, Monochrome, Cross Processing
Noise Reduction	High-ISO NR
Dynamic Range Setting	Highlight Correction, Shadow Correction
Lens Correction	Distortion Correction
Digital Filter	Toy Camera, High Contrast, Shading, Tone Expansion, Invert Color, Extract Color, Unicolor Bold, Water Color, Posterization, Slim, Fish-eye
HDR Capture	Auto, Type1, Type2

Multi-exposure	Number of Shots: 2-9 Exposure adjusted automatically.
Interval Shooting	Shooting interval: 3 sec. to 24 hr. Start Interval: immediately, from the set time Number of Shots: up to 999 images
Smart Effect	Brilliant Color, Unicolor Bold, Vintage Color, Antique, Warm Fade, Tone Expansion, Bold Monochrome, Faded Color, Vibrant Color Enhance, USER 1-3
Electronic Level	Displayed on LCD monitor (horizontal and vertical directions)



Movie

Recording Format	MPEG-4 AVC/H.264
Recorded Pixels	 (1920×1080,  , 30 fps/25 fps/24 fps)  (1280×720,  , 30 fps/25 fps/24 fps)  (640×480,  , 30 fps/25 fps/24 fps)
Sound	Built-in monaural microphone
Recording Time	Up to 25 minutes; automatically stops recording if the internal temperature of the camera becomes high.
Custom Image	Bright, Natural, Portrait, Landscape, Vibrant, Radiant, Muted, Bleach Bypass, Reversal Film, Monochrome, Cross Processing
Digital Filter	Toy Camera, High Contrast, Shading, Tone Expansion, Invert Color, Extract Color, Unicolor Bold, Water Color, Posterization, Slim, Fish-eye
Interval Movie Record	Recording interval: 3 sec., 5 sec., 10 sec., 30 sec., 1 min., 5 min., 10 min., 30 min., 1 hr. Recording time: 12 sec. to 99 hr. Start Interval: immediately, from the set time
Movie Continuous AF	Off/On

Playback Functions

Playback View	Single frame, Multi-image display (4, 9, 30, and 56 thumbnails), Image magnification (up to 16×, scrollable, quick zoom), Rotated image display, Histogram (Y histogram, RGB histogram), Highlight Alert, Auto Image Rotation, Detailed Information Display, Folder Display, Calendar Filmstrip Display, Slideshow
Delete	Single image, all images, select & delete, folder, instant review image
Digital Filter	Base Parameter Adj, Toy Camera, High Contrast, Shading, Tone Expansion, Invert Color, Extract Color, Unicolor Bold, Water Color, Posterization, Slim, Fish-eye, Retro, Sketch, Miniature, Soft, Starburst
RAW Development	File Format (JPEG), Aspect Ratio, Color Space, White Balance, Custom Image, Digital Filter, Sensitivity, High-ISO NR, Shadow Correction, Distortion Correction
Editing Features	Resize, Cropping (aspect ratio can be changed), Index, Movie Edit (dividing a movie file and deleting unwanted segments), Capturing a JPEG still picture from a movie, Red-eye Edit, Save RAW Data

Customization

Custom Functions	16 items
Mode Memory	11 items
Button/Dial Customization	 /  button: Green Button, Preview, One Push File Format, AE Lock, Enable AF Quick Dial: Smart Effect, Aspect Ratio, Focus Method, Focus Peaking, ND Filter
World Time	World Time settings for 75 cities (28 time zones)

Power Supply

Battery Type	Rechargeable Lithium-ion Battery D-LI68
AC Adapter	AC Adapter Kit K-AC115 (optional)

Battery Life	Number of recordable images (with 50% flash usage): approx. 250 images, (without flash usage): approx. 260 images Playback time: approx. 160 minutes • Tested in compliance with CIPA standard using a new rechargeable lithium-ion battery at a temperature of 23°C. Actual results may vary depending on the shooting conditions/ circumstances.
--------------	--

Interfaces

Connection Port	USB 2.0/AV output terminal, HDMI output terminal (Type D)
USB Connection	MSC/PTP
Video Output Format	NTSC/PAL

Dimensions and Weight

Dimensions	Approx. 105.0 mm (W) × 58.0 mm (H) × 34.0 mm (D) (excluding the operation parts and protrusion)
Weight	Approx. 203 g (loaded and ready with the dedicated battery and SD Memory Card) Approx. 183 g (body only)

Accessories

Package Contents	USB Cable I-USB7, Strap O-ST131, Rechargeable Lithium-ion Battery D-Li168, Battery Charger D-BC68P, AC plug cord, Software (CD-ROM) S-SW151, Start Guide <Mounted on the camera> Hot shoe cover FK, Body mount cover
Software	Digital Camera Utility 5

Approximate Image Storage Capacity and Playback Time

(When using the fully charged battery)

Battery	Temperature	Normal Shooting	Flash Photography		Playback Time
			50% Use	100% Use	
D-Li168	23°C	260	250	240	160 minutes

- The image storage capacity (normal recording and flash use 50%) is based on measuring conditions in accordance with CIPA standards, while other data is based on our measuring conditions. Some deviation from the above figures may occur in actual use depending on the selected capture mode and shooting conditions.

Approximate Image Storage Capacity by Size

(When using a 2 GB memory card)

Aspect Ratio	Recorded Pixels	JPEG Quality			RAW
		★★★	★★	★	
16:9	L 9M	544	755	1264	103
	M 5M	908	1250	2060	–
	S 2M	2183	2939	4596	–
3:2	L 10M	461	641	1077	103
	M 6M	771	1064	1764	–
	S 2M	1871	2533	4010	–
4:3	L 12M	410	571	961	103
	M 7M	687	951	1582	–
	S 3M	1679	2281	3639	–
1:1	L 9M	547	759	1270	103
	M 5M	908	1250	2060	–
	S 2M	2183	2939	4596	–

- The number of storable images may vary depending on the subject, shooting conditions, selected capture mode and memory card, etc.

Operating Environment for USB Connection and Provided Software

With the provided software "Digital Camera Utility 5", you can develop RAW files on a computer. Install the software from the provided CD-ROM (S-SW151).

We recommend the following system requirements to connect the camera to a computer and to use the software.

Windows

OS	Windows 8.1 (32-bit, 64-bit), Windows 8 (32-bit, 64-bit), Windows 7 (32-bit, 64-bit) or Windows Vista (32-bit, 64-bit)
CPU	Intel Core 2 Duo or higher
RAM	2 GB or more
HDD	For installing and starting up the program: 100 MB or more of available space For saving image files: Approx. 5 MB/file (JPEG), Approx. 25 MB/file (RAW)
Monitor	1280×1024 dots, 24-bit full color or higher

Macintosh

OS	OS X 10.9, 10.8 or 10.7, or Mac OS X 10.6
CPU	Intel Core 2 Duo or higher
RAM	2 GB or more
HDD	For installing and starting up the program: 100 MB or more of available space For saving image files: Approx. 5 MB/file (JPEG), Approx. 25 MB/file (RAW)
Monitor	1280×1024 dots, 24-bit full color or higher

Memo

- QuickTime is required to play back movies transferred to a computer. You can download it from the following site:
<http://www.apple.com/quicktime/download/>

For Using Your Camera Safely

We have paid close attention to the safety of this camera. When using this camera, we request your special attention regarding items marked with the following symbols.



Warning

This symbol indicates that ignoring this item could cause serious personal injuries.



Caution

This symbol indicates that ignoring this item could cause minor or medium personal injuries, or loss of property.

About the Camera



Warning

- Do not disassemble or modify the camera. High voltage areas are present inside the camera, with the risk of electric shock.
- If the camera interior is exposed due to dropping or otherwise damaging the camera, never touch the exposed portion. There is a risk of electric shock.
- Do not aim the camera at the sun or other strong light sources when taking pictures or leave the camera sitting in direct sunlight with the lens cap off. Doing so may cause the camera to malfunction or cause a fire.
- Do not look at the sun or other strong light sources through a lens. Doing so may lead to a loss of eyesight or cause vision to be impaired.
- If any irregularities occur during use, such as smoke or a strange odor, stop use immediately, remove the battery or the AC adapter, and contact your nearest service center. Continued use can cause a fire or electrical shock.



Caution

- Do not place your finger over the flash when discharging the flash. You may burn yourself.
- Do not cover the flash with clothing when discharging the flash. Discoloration may occur.
- Some portions of the camera heat up during use. There is a risk of low temperature burns when holding such portions for long periods.

- Should the monitor be damaged, be careful of glass fragments. Also, be careful not to allow the liquid crystal to get on your skin or in your eyes or mouth.
- Depending on your individual factors or physical condition, the use of the camera may cause itching, rashes or blisters. In case of any abnormality, stop using the camera and get medical attention immediately.

About the Battery Charger and AC Adapter



Warning

- Always use the battery charger and AC adapter exclusively developed for this camera, with the specified power and voltage. Using a battery charger or AC adapter not exclusive to this camera, or using the exclusive battery charger or AC adapter with an unspecified power or voltage can cause a fire, electric shock, or camera breakdown. The specified voltage is 100 - 240V AC.
- Do not disassemble or modify the product. This can cause a fire or electrical shock.
- If the generation of smoke or strange odor from the product or other abnormality occurs, immediately discontinue using and consult your nearest service center. Continued use can cause a fire or electrical shock.
- If water should happen to get inside the product, consult your nearest service center. Continued use can cause a fire or electrical shock.
- If you see a lightning flash or hear thunder during use of the battery charger or AC adapter, unplug the power plug and discontinue using. Continued use can cause damage to the product, fire or electrical shock.
- Wipe off the power plug if it should become covered with dust. Accumulated dust may cause a fire.
- To reduce the risk of hazards, use only CSA/UL certified power supply cord set, cord is Type SPT-2 or heavier, minimum NO.18 AWG copper, one end with a molded-on male attachment plug cap (with a specified NEMA configuration), and the other is provided with a molded-on female connector body (with a specified IEC nonindustrial type configuration) or the equivalent.



Caution

- Do not place or drop heavy objects on or forcefully bend the AC plug cord. Doing so may damage the cord. Should the AC plug cord be damaged, consult your nearest service center.

- Do not touch or short-circuit the terminal area of the AC plug cord while the cord is plugged in.
- Do not handle the power plug with wet hands. This can cause an electric shock.
- Do not drop the product, or subject it to violent impact. This can cause the product to breakdown.
- Do not use the battery charger D-BC68P to charge batteries other than the rechargeable lithium-ion battery D-LI68. Attempting to charge other types of batteries may cause an explosion or heating, or may damage the battery charger.

About the Rechargeable Lithium-ion Battery

Warning

- If any leakage from the battery should come in contact with your eyes, do not rub them. Flush your eyes with clean water and get medical attention immediately.

Caution

- Only use the specified battery with this camera. Use of other batteries may cause an explosion or fire.
- Do not disassemble the battery. Disassembling the battery may cause an explosion or leakage.
- Remove the battery from the camera immediately if it becomes hot or begins to smoke. Be careful not to burn yourself during removal.
- Keep wires, hairpins, and other metal objects away from the + and - contacts of the battery.
- Do not short the battery or dispose of the battery in fire. This can cause an explosion or fire.
- If any leakage from the battery should come in contact with skin or clothing, it may cause irritation to the skin. Wash the affected areas thoroughly with water.
- Precautions for D-LI68 Battery Usage:
 - USE SPECIFIED CHARGER ONLY.
 - DO NOT INCINERATE.
 - DO NOT DISASSEMBLE.
 - DO NOT SHORT CIRCUIT.
 - DO NOT EXPOSE TO HIGH TEMP. (140°F / 60°C)

Keep the Camera and its Accessories out of the Reach of Small Children

Warning

- Do not place the camera and its accessories within the reach of small children.
 1. If the product falls or is operated accidentally, it may cause serious personal injuries.
 2. Wrapping the strap around a neck may cause suffocation.
 3. To avoid the risk of a small accessory such as the battery or memory cards from being swallowed by mistake, keep them out of the reach of small children. Seek medical attention immediately if an accessory is accidentally swallowed.

Care to be Taken During Handling

Before Using Your Camera

- When the camera has not been used for a long time, confirm that it is still working properly, particularly prior to taking important pictures (such as at a wedding or when traveling). Contents of the recording cannot be guaranteed if recording, playback or transferring your data to a computer, etc. is not possible due to a malfunction of your camera or recording media (memory cards), etc.

About the Battery and Charger

- To keep the battery in optimum condition, avoid storing it in a fully charged state or in high temperatures.
- If the battery is left inserted and the camera is not used for a long time, the battery will over-discharge and shorten the battery's life.
- Charging the battery a day before use or on the day of use is recommended.
- The AC plug cord provided with this camera is developed exclusively for the battery charger D-BC68P. Do not use it with other devices.

Precautions on Carrying and Using Your Camera

- Do not subject the camera to high temperatures or high humidity. Do not leave the camera in a vehicle, as the temperature can get very high.
- Do not subject the camera to strong vibrations, shocks, or pressure. Use a cushion to protect the camera from vibrations of motorcycles, automobiles, or ships.
- The temperature range for camera use is 0°C to 40°C (32°F to 104°F).
- The monitor may appear black at high temperatures, but will return to normal at normal temperatures.
- The monitor may respond more slowly at low temperatures. This is due to liquid crystal properties, and is not a malfunction.

- Sudden temperature changes will cause condensation on the inside and outside of the camera. Place the camera in your bag or a plastic bag, and remove it after temperatures of the camera and surroundings are equalized.
- Avoid contact with garbage, mud, sand, dust, water, toxic gases, or salt. These could cause the camera to breakdown. Wipe the camera to dry off any rain or water drops.
- Do not press on the monitor with excessive force. This could cause it to break or malfunction.
- Be careful not to overtighten the screw in the tripod socket when using a tripod.

Cleaning Your Camera

- Do not clean the camera with organic solvents such as thinner, alcohol, and benzene.
- Use a lens brush to remove dust accumulated on the lens. Never use a spray blower for cleaning as it may damage the lens.
- Please contact your nearest service center for professional cleaning of the CMOS sensor. (This will involve a fee.)
- Periodic inspections are recommended every one to two years to maintain high performance.

Storing Your Camera

- Do not store the camera with preservatives or chemicals. Storage in high temperatures and high humidity can cause mold to grow on the camera. Remove the camera from its case and store it in a dry and well-ventilated place.
- Avoid using or storing the camera where it may be exposed to static electricity or electrical interference.
- Avoid using or storing the camera in direct sunlight or in locations where it may be exposed to rapid changes in temperature or to condensation.

About SD Memory Cards

- The SD Memory Card is equipped with a write-protect switch. Setting the switch to LOCK prevents new data from being recorded on the card, the stored data from being deleted, and the card from being formatted by the camera or computer.
- The SD Memory Card may be hot when removing the card immediately after using the camera.
- Do not remove the SD Memory Card or turn off the power while the card is being accessed. This may cause the data to be lost or the card to be damaged.
- Do not bend the SD Memory Card or subject it to violent impact. Keep it away from water and store away from high temperatures.
- Do not remove the SD Memory Card while formatting. The card may be damaged and become unusable.
- Data on the SD Memory Card may be deleted in the following circumstances. We do not accept any liability for data that is deleted if
 1. the SD Memory Card is mishandled by the user.
 2. the SD Memory Card is exposed to static electricity or electrical interference.
 3. the SD Memory Card has not been used for a long time.
 4. the SD Memory Card or the battery is removed while the card is being accessed.
- If the SD Memory Card is not used for a long time, the data on the card may become unreadable. Be sure to regularly make a backup of important data on a computer.
- Format new SD Memory Cards. Also format SD Memory Cards previously used with other cameras.
- Please note that deleting data stored on an SD Memory Card, or formatting an SD Memory Card does not completely erase the original data. Deleted data can sometimes be recovered using commercially available software. If you are going to discard, give away or sell your SD Memory Card, you should ensure that the data on the card is completely deleted or the card itself is destroyed if it contains any personal or sensitive information.
- The data on your SD Memory Card should be managed at your own risk.

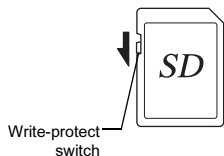

About Eye-Fi Cards

- An SD Memory Card with a built-in wireless LAN ("Eye-Fi card") can be used with this camera.
- Use of an access point and an Internet connection are required for transferring images via wireless LAN. For details, refer to the Eye-Fi website. (<http://www.eye.fi>)
- Update your Eye-Fi card to the latest firmware before using it.
- Set [Eye-Fi Communication] of [Eye-Fi] to [OFF], or do not use an Eye-Fi card in a location where the use of wireless LAN devices is restricted or prohibited, such as airplanes.
- Eye-Fi cards can be used only in the country in which the card was purchased. Please observe all local laws governing the Eye-Fi card usage.
- This camera features a function to enable/disable the communication function of the Eye-Fi card, however, we do not guarantee the operability of all Eye-Fi card functions.
- Refer to the Eye-Fi card manual for details on how to use the card.
- Please contact the Eye-Fi card manufacturer regarding any malfunctions or problems concerning Eye-Fi cards.

Trademarks

Microsoft, Windows and Windows Vista are registered trademarks of Microsoft Corporation in the United States of America and other countries.

Macintosh, Mac OS, and QuickTime are trademarks of Apple Inc., registered in the U.S. and other countries.

Intel, Intel Core, and Pentium are trademarks of Intel Corporation in the U.S. and/or other countries.

SDXC Logo is a trademark of SD-3C, LLC.

Eye-Fi, the Eye-Fi logo and Eye-Fi *connected* are trademarks of Eye-Fi, Inc.

This product includes DNG technology under license by Adobe Systems Incorporated.

The DNG logo is either a registered trademark or trademark of Adobe Systems Incorporated in the United States and/or other countries.

HDMI, the HDMI logo and High-Definition Multimedia Interface are trademarks or registered trademarks of HDMI Licensing, LLC in the United States and/or other countries.

All other trademarks are the property of their respective owners.

This product supports PRINT Image Matching III. PRINT Image Matching enabled digital still cameras, printers and software help photographers to produce images more faithful to their intentions. Some functions are not available on printers that are not PRINT Image Matching III compliant.

Copyright 2001 Seiko Epson Corporation. All Rights Reserved. PRINT Image Matching is a trademark of Seiko Epson Corporation. The PRINT Image Matching logo is a trademark of Seiko Epson Corporation.



AVC Patent Portfolio License

This product is licensed under the AVC Patent Portfolio License for the personal use of a consumer or other uses in which it does not receive remuneration to (i) encode video in compliance with the AVC standard ("AVC video") and/or (ii) decode AVC video that was encoded by a consumer engaged in a personal activity and/or was obtained from a video provider licensed to provide AVC video. No license is granted or shall be implied for any other use.

Additional information may be obtained from MPEG LA, L.L.C. See <http://www.mpegla.com>.

WARRANTY POLICY

All our cameras purchased through authorized bona fide photographic distribution channels are guaranteed against defects of material or workmanship for a period of twelve months from the date of your purchase. Service will be rendered, and defective parts will be replaced without cost to you within that period, provided the camera does not show evidence of impact, sand or liquid damage, mishandling, tampering, battery or chemical corrosion, operation contrary to operating instructions, or modification by an unauthorized repair shop. The manufacturer or its authorized representatives shall not be liable for any repair or alterations except those made with its written consent and shall not be liable for damages from delay or loss of use or from other indirect or consequential damages of any kind, whether caused by defective material or workmanship or otherwise; and it is expressly agreed that the liability of the manufacturer or its representatives under all guarantees or warranties, whether expressed or implied, is strictly limited to the replacement of parts as hereinbefore provided. No refunds will be made on repairs by non-authorized service facilities.

Procedure During 12-month Warranty Period

Any camera which proves defective during the 12-month warranty period should be returned to the dealer from whom you purchased the camera or to the manufacturer. If there are no representatives of the manufacturer in your country, send the camera to the manufacturer, with postage prepaid. In this case, it will take a considerable length of time before the camera can be returned to you owing to the complicated customs procedures required. If the camera is covered by warranty, repairs will be made and parts replaced free of charge,

and the camera will be returned to you upon completion of servicing. If the camera is not covered by warranty, regular charges of the manufacturer or of its representatives will apply. Shipping charges are to be borne by the owner. If your camera was purchased outside of the country where you wish to have it serviced during the warranty period, regular handling and servicing fees may be charged by the manufacturer's representatives in that country. Notwithstanding this, your camera returned to the manufacturer will be serviced free of charge according to this procedure and warranty policy. In any case, however, shipping charges and customs clearance fees to be borne by the sender. To prove the date of your purchase when required, please keep the receipt or bills covering the purchase of your camera for at least a year. Before sending your camera for servicing, please make sure that you are sending it to the manufacturer's authorized representatives or their approved repair shops, unless you are sending it directly to the manufacturer. Always obtain a quotation for the service charge, and only after you accept the quoted service charge, instruct the service station to proceed with the servicing.

- **This warranty policy does not affect the customer's statutory rights.**
- **The local warranty policies available from our distributors in some countries can supersede this warranty policy. Therefore, we recommend that you review the warranty card supplied with your product at the time of purchase, or contact our distributor in your country for more information and to receive a copy of the warranty policy.**

For customers in USA

STATEMENT OF FCC COMPLIANCE

This device complies with Part 15 of the FCC Rules. Operation is subject to the following two conditions: (1) This device may not cause harmful interference, and (2) this device must accept any interference received, including interference that may cause undesired operation.

Changes or modifications not approved by the party responsible for compliance could void the user's authority to operate the equipment.

This equipment has been tested and found to comply with the limits for a Class B digital device, pursuant to part 15 of the FCC Rules.

These limits are designed to provide reasonable protection against harmful interference in a residential installation. This equipment generates, uses and can radiate radio frequency energy and, if not installed and used in accordance with the instructions, may cause harmful interference to radio communications. However, there is no guarantee that interference will not occur in a particular installation.

If this equipment does cause harmful interference to radio or television reception, which can be determined by turning the equipment off and on, the user is encouraged to try to correct the interference by one or more of the following measures:

- Reorient or relocate the receiving antenna.
- Increase the separation between the equipment and receiver.
- Connect the equipment into an outlet on a circuit different from that to which the receiver is connected.

* Consult the dealer or an experienced radio/TV technician for help.

For customers in Canada

This Class B digital apparatus complies with Canadian ICES-003.

Pour les utilisateurs au Canada

Cet appareil numérique de la classe B est conforme à la norme NMB-003 du Canada.

FOR CALIFORNIA, U.S.A. ONLY

Perchlorate Material-special handling may apply.

The lithium battery used in this camera contains perchlorate material, which may require special handling.

See www.dtsc.ca.gov/hazardouswaste/perchlorate

Declaration of Conformity

According to 47CFR, Parts 2 and 15 for
Class B Personal Computers and Peripherals

We: RICOH IMAGING AMERICAS
CORPORATION

Located at: 633 17th Street, Suite 2600
Denver, Colorado 80202 U.S.A.
Phone: 800-877-0155
FAX: 303-790-1131

Declare under sole responsibility that the product identified herein complies with 47CFR Parts 2 and 15 of the FCC rules as a Class B digital device. Each product marketed is identical to the representative unit tested and found to be compliant with the standards. Records maintained continue to reflect the equipment being produced can be expected to be within the variation accepted, due to quantity production and testing on the statistical basis as required by 47CFR §2.909. Operation is subject to the following two conditions: (1) This device may not cause harmful interference, and (2) This device must accept any interference received, including interference that may cause undesired operation. The above named party is responsible for ensuring that the equipment complies with the standards of 47CFR §15.101 to §15.109.

Product Name: Digital Camera
Model Number: PENTAX Q-S1
Contact person: Customer Service Manager
Date and Place: August, 2014, Colorado

Information for Users on Collection and Disposal of Old Equipment and Used Batteries



1. In the European Union

These symbols on the products, packaging and/or accompanying documents mean that used electrical and electronic equipment and batteries should not be mixed with general household waste.

Used electrical/electronic equipment and batteries must be treated separately and in accordance with legislation that requires proper treatment, recovery and recycling of these products.



By disposing of these products correctly you will help ensure that the waste undergoes the necessary treatment, recovery and recycling and thus prevent potential negative effects on the environment and human health which could otherwise arise due to inappropriate waste handling.

If a chemical symbol is added beneath the symbol shown above, in accordance with the Battery Directive, this indicates that a heavy metal (Hg = Mercury, Cd = Cadmium, Pb = Lead) is present in the battery at a concentration above an applicable threshold specified in the Battery Directive.

For more information about collection and recycling of used products, please contact your local authorities, your waste disposal service or the point of sale where you purchased the products.

2. In other countries outside the EU

These symbols are only valid in the European Union. If you wish to discard used products, please contact your local authorities or dealer and ask for the correct method of disposal.

For Switzerland: Used electrical/electronic equipment can be returned free of charge to the dealer, even when you don't purchase a new product. Further collection facilities are listed on the home page of www.swico.ch or www.sens.ch.



The CE Mark is a Directive conformity mark of the European Union.

Information on the Operating Manual

An Operating Manual (PDF) containing information on how to use this camera is available. Please download it from our website. A printed version can also be purchased upon request. Please contact your nearest service center.

Operating Manual Download:

<http://www.ricoh-imaging.com/manuals/>



User Registration:

<http://www.ricoh-imaging.com/registration/>

Memo

RICOH IMAGING COMPANY, LTD.

2-35-7, Maeno-cho, Itabashi-ku, Tokyo 174-8639, JAPAN
(<http://www.ricoh-imaging.co.jp>)

**RICOH IMAGING EUROPE
S.A.S**

112 Quai de Bezons, B.P. 204, 95106 Argenteuil Cedex, FRANCE
(<http://www.ricoh-imaging.fr>)

**RICOH IMAGING
DEUTSCHLAND GmbH**

Am Kaiserkai 1, 20457 Hamburg, GERMANY
(<http://www.ricoh-imaging.de>)

RICOH IMAGING UK LTD.

PENTAX House, Heron Drive, Langley, Slough, Berks SL3 8PN, U.K.
(<http://www.ricoh-imaging.co.uk>)

**RICOH IMAGING AMERICAS
CORPORATION**

633 17th Street, Suite 2600, Denver, Colorado 80202, U.S.A.
(<http://www.us.ricoh-imaging.com>)

**RICOH IMAGING CANADA
INC.**

520 Explorer Drive Suite 300, Mississauga, Ontario, L4W 5L1, CANADA
(<http://www.ricoh-imaging.ca>)

**RICOH IMAGING CHINA CO.,
LTD.**

23D, Jun Yao International Plaza, 789 Zhaojiabang Road, Xu Hui District,
Shanghai, 200032, CHINA
(<http://www.ricoh-imaging.com.cn>)

- Specifications and external dimensions are subject to change without notice.

Free Manuals Download Website

<http://myh66.com>

<http://usermanuals.us>

<http://www.somanuals.com>

<http://www.4manuals.cc>

<http://www.manual-lib.com>

<http://www.404manual.com>

<http://www.luxmanual.com>

<http://aubethermostatmanual.com>

Golf course search by state

<http://golfingnear.com>

Email search by domain

<http://emailbydomain.com>

Auto manuals search

<http://auto.somanuals.com>

TV manuals search

<http://tv.somanuals.com>