

PENTAX®

ZOOM 70-X

ZOOM 70-X DATE

OPERATING MANUAL



OUTLINE OF BASIC OPERATIONS

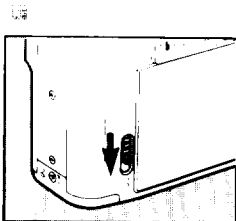

Open the back cover
(see page 7).

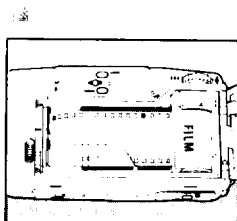

Load the film and close the
back cover.

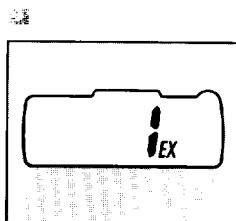

The film automatically
advances to the first frame.

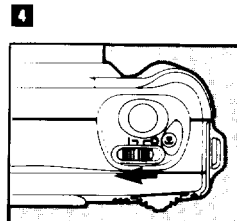

Set the main switch to (|)
(see page 3).

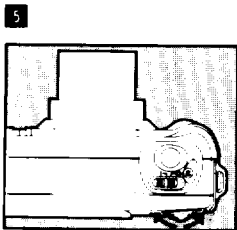

Frame your subject and
operate the zooming lever to
determine the composition
(see page 5).

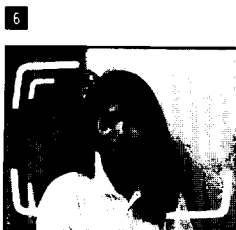

Focus your subject
(see page 12).

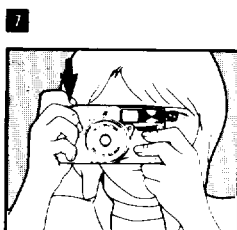

Press the shutter release
button. In dark conditions,
the flash fires automatically.

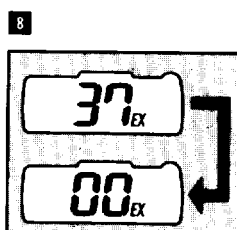

When the film reaches its
end, the camera automati-
cally rewinds the film
(see page 16).

Welcome to the world of Pentax zoom compact photography! Your compact, lightweight camera is a great companion to preserve your favorite memories.

Its built-in 35 — 70 mm zoom lens gives you the freedom to frame everything from breathtaking landscapes to family portraits, even detailed close-ups. Built-in auto flash helps you capture a subject in a dimly-lit night or an indoor scene with clarity and brilliance, and functions as a fill-in flash for daylight flash-sync photography. Since most of the operations — including film loading, film speed setting, winding/rewinding, focus and exposure control — are automatic, you can take great pictures with little effort. The DATE model makes it easy to remember when you take pictures.

Please read this manual carefully before operating the camera to learn how to take consistently flawless pictures.

Names of the camera's working parts are listed on the front and back flaps of this manual. Keep the flaps unfolded for quick reference while you read.

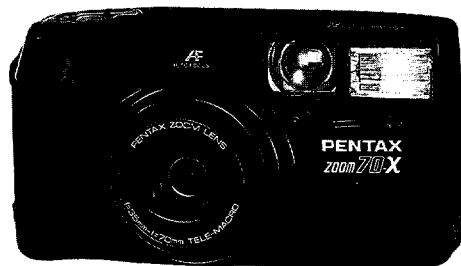

NAMES OF WORKING PARTS

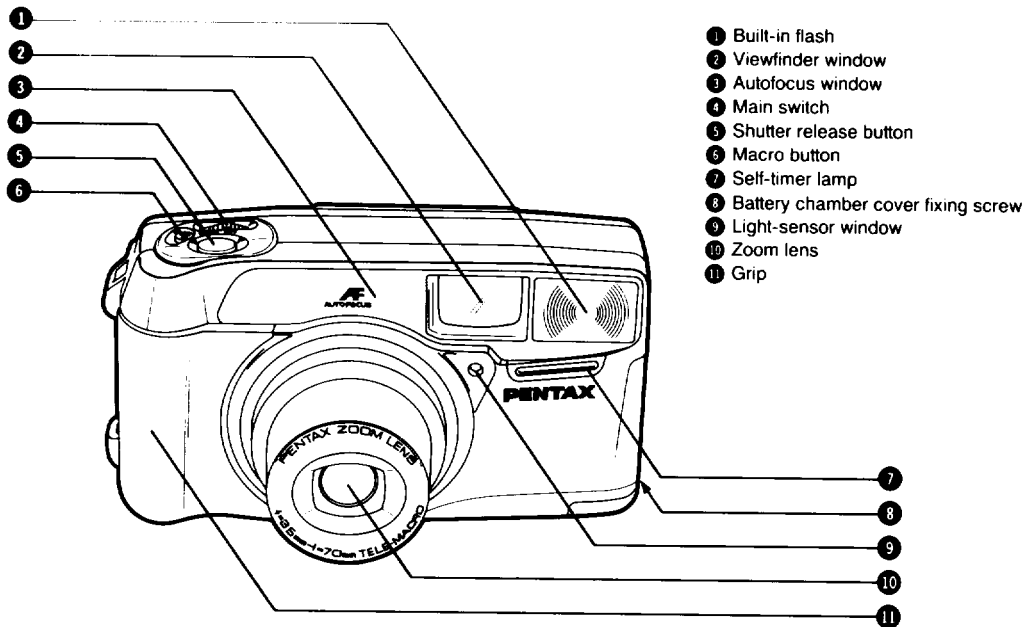

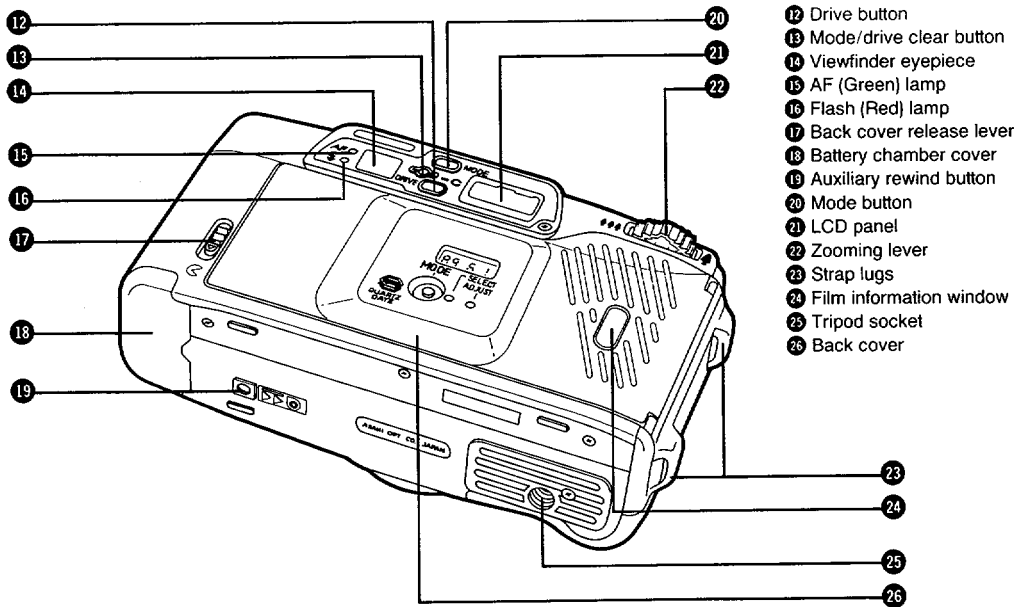

- 12 Drive button
- 13 Mode/drive clear button
- 14 Viewfinder eyepiece
- 15 AF (Green) lamp
- 16 Flash (Red) lamp
- 17 Back cover release lever
- 18 Battery chamber cover
- 19 Auxiliary rewind button
- 20 Mode button
- 21 LCD panel
- 22 Zooming lever
- 23 Strap lugs
- 24 Film information window
- 25 Tripod socket
- 26 Back cover

SPECIFICATIONS

SPECIFICATIONS ARE SUBJECT TO CHANGE WITHOUT ANY OBLIGATION ON THE PART OF THE MANUFACTURER.

Type:

35 mm fully automatic leaf-shutter camera with built-in zoom lens and auto flash.

Film:

Auto film speed setting with 35 mm perforated DX-coded film with ISO rating from 50 to 1600. 24 x 36 mm format.

Lens:

Pentax power zoom 35 — 70 mm f:3.5 — 6.7, 7 elements in 6 groups. Two zooming speeds.

Focusing system:

Pentax infrared active auto focusing. Range: 1 m (3.3 ft) — infinity; 0.6 m (2 ft) — 1 m (3.3 ft) in MACRO.

Exposure control:

Programmed auto-exposure control. Range: EV 9 — 16.5 in WIDE, EV11 — 16.5 in TELE and MACRO at Auto mode (ISO 100). +1.5 EV exposure compensation provided.

Viewfinder:

Zoom finder with albedo-bright frame. Magnification: approx. 0.49X (WIDE) — 0.90X (TELE).

Shutter:

Programmed AE between-the-lens shutter with speeds approx. 1/5 sec. — 1/250 sec. and Bulb (1/2 — 8 sec.). Multiple exposure function provided.

Self-timer:

10 second delay self-timer with LED indication. Dual-frame self-timer mode provided.

Flash:

Built-in zoom flash. Recycle time: approx. 3 sec. with fresh lithium batteries.

Film loading/winding:

Auto film-loading. Two auto film-winding modes: single frame mode and consecutive mode (1.2 sec./frame).

Film rewinding:

Auto start at end of roll. Auto stop upon completion of rewinding. Rewinding in mid-roll provided.

Power source:

Two 3V lithium batteries (CR-123A or DL-123A)

Battery life:

Approx. 125 rolls of 24-exposure film without flash.

Size & weight:

137 (W) x 75.5 (H) x 48.5 (D) mm (5.4" x 3" x 1.9");
380 grams (13.4 oz.) without battery.

DATE model

Imprinting mode:

"Year, Month and Day", "Day, Hour and Minute" or blank.

Size & weight:

137 (W) x 75.5 (H) x 50.5 (D) mm (5.4" x 3" x 2");
390 grams (13.8 oz.) without battery.

- Names of working parts Flaps
- Outline of basic operations Inside cover

PRESHOOTING PREPARATIONS

1. Strap and soft case ②
2. Main switch and battery check ③
3. How to hold the camera ④
4. Operating 35 — 70 mm zoom lens ⑤

BASIC OPERATIONS

1. Usable film ⑥
2. Film loading ⑦
3. Viewfinder displays and shooting ranges ⑩
4. Green/red lamps ⑪
5. Ordinary photography ⑪
6. Taking pictures ⑫
7. Focus-lock shooting ⑭
8. Unloading film ⑮

OPERATIONS OF MAJOR FUNCTIONS

- Taking macro pictures ⑱
- How to select modes ⑳
- Flash-On (forced emission) ㉑
- Flash-Off (flash override) ㉒
- Exposure Compensation ㉓
- Bulb and Bulb-Synchro ㉔
- Consecutive Shooting ㉕
- Self-Timer ㉖
- Dual-Frame Self-Timer ㉗
- Multi-Exposure ㉘
- Combination chart of exposure and shooting systems ㉙
- DATE model ㉚
- Battery exhaustion warning ㉛
- Replacing batteries ㉜
- Taking care of your camera ㉝
- Troubleshooting ㉞
- Warranty policy ㉟
- Specifications ㊱

PRESHOOTING PREPARATIONS

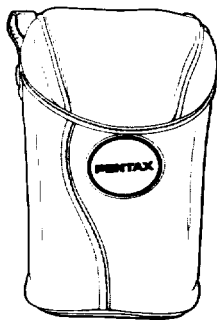

Soft case (optional)

When putting the camera into the soft case, be sure to turn the main switch off ().

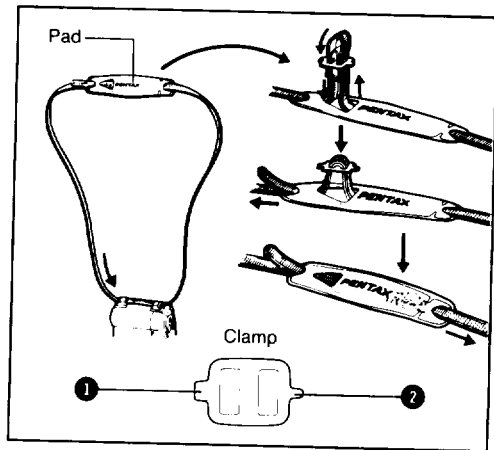

Strap

Fit the strap on the camera as illustrated.

Use the clamp's protrusion **1** as a screwdriver to open the battery chamber cover.

On the DATE model, use protrusion **2** to press the SELECT and ADJUST buttons.

2. MAIN SWITCH AND BATTERY CHECK

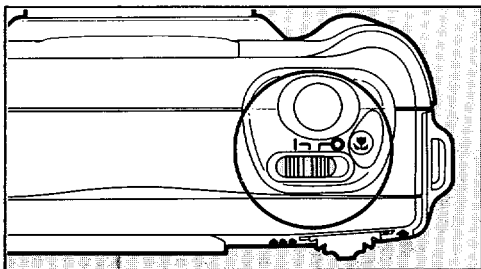

Main switch

On (**|**): The power is on, and the camera is ready for setting and shooting.

Off (**○**): The power is off, and the camera is not in use.

Caution:

The lens protector automatically opens when the main switch is on (**|**), and closes when the main switch is off (**○**). Never attempt to open the lens protector by hand.

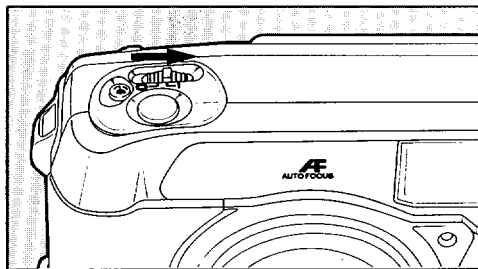

Battery check

After you turn the main switch on (**|**), the lens slightly extends and the lens protector opens. Then you can shoot.

Notes:

- If you have a DATE model, do not remove the batteries until they are exhausted, since they are used to keep constant track of time for the date function.
- Refer to page 34 for directions on battery insertion.

3. HOW TO HOLD THE CAMERA

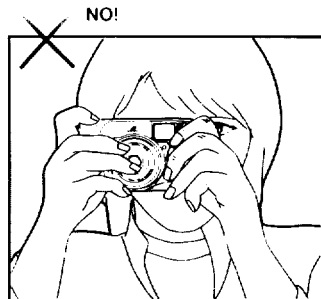
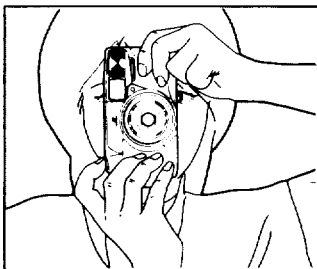
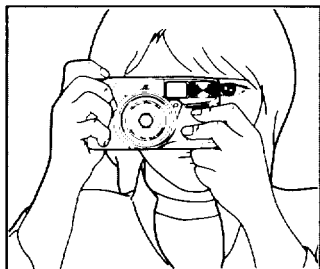

When shooting, hold the camera securely with both hands. Keep the camera as still as possible, and gently press the shutter release button. (If pressed forcefully, the camera is likely to shake, and the picture will be blurred.) Try to brace your elbows against your body, or support yourself and the camera against a stable, stationary object, such as a wall.

When using flash with the camera vertically positioned, hold the camera so that the flash is above the lens.

Caution:

Do not hold the zoom lens because it moves back and forth when zooming.

Note:

- Do not place your fingers or hair on the lens, autofocus window, sensor window, flash, etc.

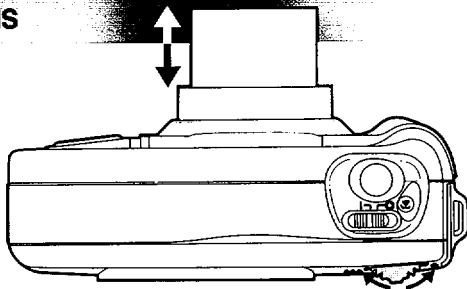
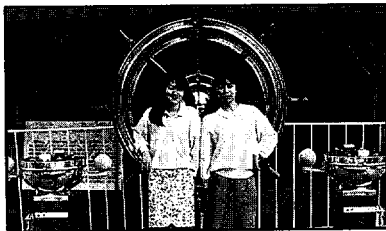
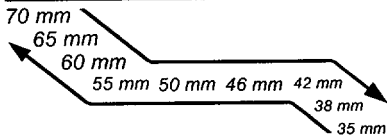

When you press the zooming lever to the right (▲), the lens frames the subject more tightly, moving towards the 70 mm telephoto setting. When you press the zooming lever to the left (▲▲▲), the lens moves towards the wider-angle 35 mm setting.

Frame your subject. Release the zooming lever when you attain the desired composition. Then, press the shutter release button.

Notes:

- As you press the zooming lever, the lens focal length is displayed on the LCD panel. (The shutter is not released when zooming.)
- The zoom lens has two operational speeds. It moves slowly when the zooming lever is pressed lightly, and moves quickly when the lever is pressed further.
- When the camera is left for more than 3 minutes with the main switch on (I), the lens automatically returns to the 35 mm (wide-angle) position.

BASIC OPERATIONS

After reading this instruction manual to familiarize yourself with operations, you're ready to insert the film.

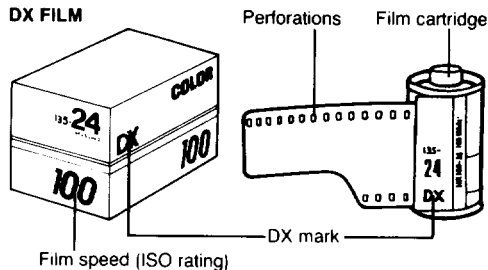

Automatic film speed setting

This camera is designed to use DX-coded films with ISO ratings from 50 to 1600. When such film is loaded, its film speed is automatically set in the camera.

Notes:

- When buying DX film, make sure the package bears the "DX" mark.
- If non-DX film is loaded, the film speed will be automatically set to ISO 100, regardless of the film's actual speed.
- Use high-speed film with an ISO rating of 1000 or 1600 mainly for shooting indoors or in dimly-lit conditions.

FILM LOADING

Turn on the power by setting the main switch to (O).

1

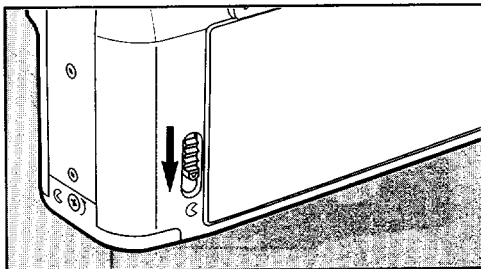

- 1 Slide the back cover release lever in the direction of the arrow as illustrated to open the back cover.

2

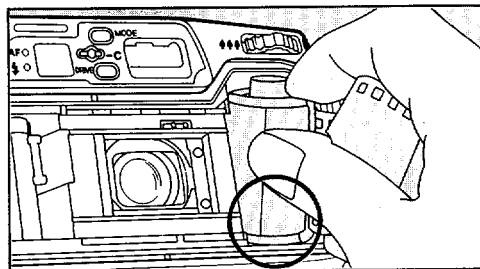

- 2 Place the film cartridge in the film chamber, fitting its flat side on the top of the rewind shaft.

7

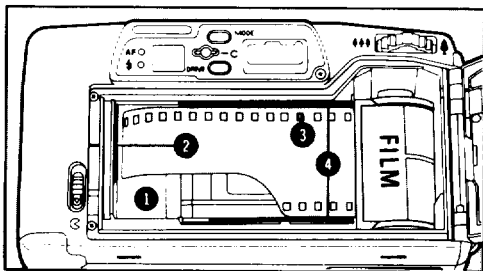

- 3** Pull the film leader out far enough from the cartridge to reach the take-up spool **1**. Align the tip with the film leader end mark **2**.

Notes:

- Make sure the film perforations properly engage the sprocket teeth **3**.
- Make sure the film is properly placed between the guide rails **4**.
- Make sure the film is taut as illustrated. Take up any slack in the film by pushing it back into the cartridge.
- If the end of the film leader is extremely bent, straighten it or cut off the bent portion.

8

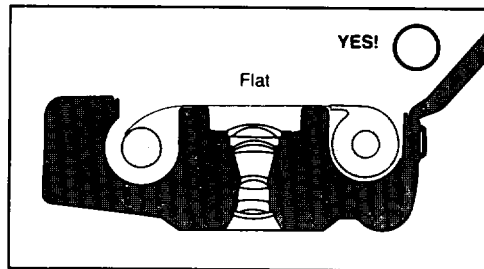
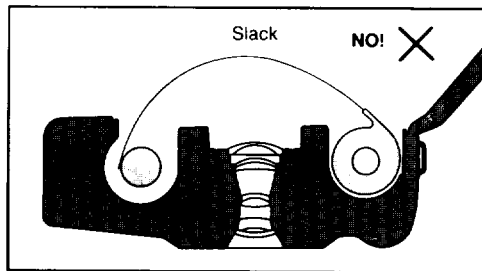

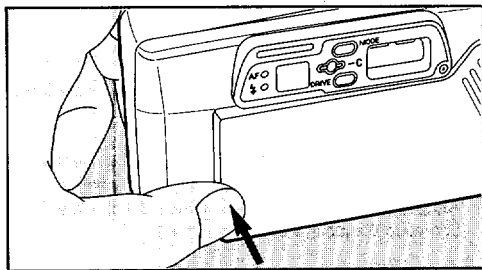
4

- 4** Close the back cover. The film automatically advances to the first frame. (Even if no film is loaded, the motor operates for a second or two after the back cover is closed.)

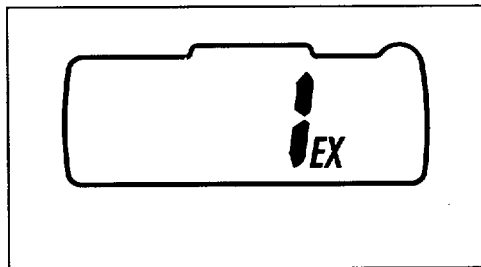
5

- 5** When "1" appears in the exposure counter on the LCD panel, the film automatically stops winding. The indication as shown above appears.

Notes:

- If "1" does not appear on the LCD panel, the film is not properly loaded. Reload the film.
- After the shutter is released for each exposure, the film automatically advances to the next frame, unless the camera is in Multi-Exposure mode.

3. VIEWFINDER DISPLAYS AND

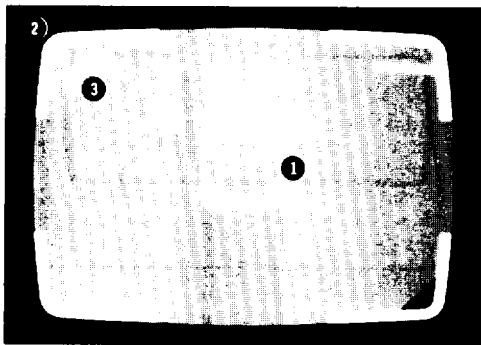

1 Autofocus frame

Position this frame at the subject of focus.

2 Picture-area frame

This is the ordinary picture area. Compose the picture within this frame.

3 Parallax-correction frame

When taking a macro picture in which the subject is about 0.6 meters (2 ft) away, or an ordinary shot in which the subject is about one meter (3.3 ft) away, compose the picture within this frame.

← Part of the lens front appears in the viewfinder when the lens is in its wide-angle position, but this won't appear on the film when the picture is taken.

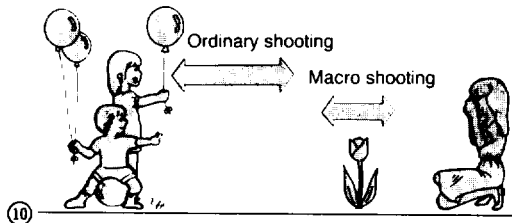

Shooting ranges

(effective camera-to-subject distance)

- The ordinary setting allows a shooting range from ∞ (infinity) to one meter (3.3 ft).
- The macro setting allows a shooting range from one meter (3.3 ft) to 0.6 meters (2 ft). No subject closer than 0.6 meters can be clearly photographed.

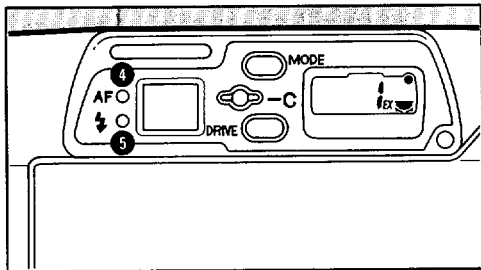

When you press the shutter release button half-way, the lamps 4 and/or 5 as shown above glow or flicker.

- 4 **Green lamp:** When it glows you can take a picture. When it flickers, you cannot.
- 5 **Red lamp:** When it glows, flash is ready to fire. When it flickers, flash is being charged.

Note:

- If the green lamp flickers in the ordinary or macro settings, the subject is either too close or too far. Adjust the camera-to-subject distance so that the green lamp glows, then release the shutter.

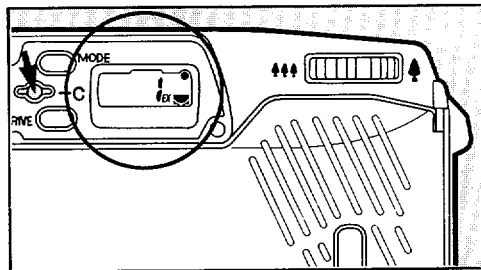

When the LCD panel is as shown above, the camera is in the Auto and Single-Frame Shooting modes. These modes are used for ordinary picture-taking situations. If the LCD panel displays indications other than those above, press the mode/drive clear (C) button to reset the LCD panel to appear as above.

6. TAKING PICTURES



- 1 After zooming and composing your shot, position the autofocus frame () on the subject.

2

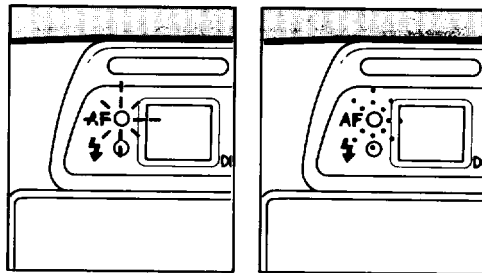

- 2 Press the shutter release button half-way with your subject in focus, and the green lamp glows. If the subject is closer than one meter (3.3 ft), the green lamp flickers and the shutter cannot be released. In this case, lengthen the camera-to-subject distance.

Note:

- If you wish to shift subject focus, release your finger from the shutter release button and press the shutter release button half-way again.

3

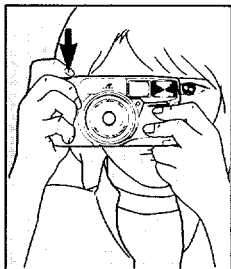

*

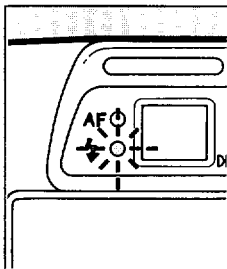

3 Press the shutter release button all the way down, and the shutter is released.

Then, the film automatically advances to the next frame.

Notes:

- When the shutter is released, the self-timer lamp glows momentarily to indicate that a shot has been taken.
- When the green lamp flickers, the (M) macro mark on the LCD panel also flickers to recommend use of macro mode.
- The shutter cannot be released while the lens is zooming.

* When taking pictures in the dark, the flash automatically fires.

When the shutter release button is lightly pressed in dark lighting, the red lamp glows, indicating that flash is ready to fire. A flickering red lamp means the flash is being charged.

Therefore, make sure the red lamp glows before shooting.

Flash-effective ranges (Nega-color film used)

Lens ISO	50	100	400	1600
35mm (▲▲▲)	1 ~ 3.5 m	1 ~ 5 m	1 ~ 10 m	1 ~ 18 m*
70mm (▲)	1 ~ 2.5 m	1 ~ 3.5 m	1 ~ 7 m	1 ~ 12 m
Macro (M)	0.6 ~ 1 m	0.6 ~ 1 m	0.6 ~ 1 m	—

* Because of high film speed, overexposure may occur at close range.

Red eye

Shooting portraits with the flash may result in "red-eye", the red spots in your subject's eye. Refer to page 39 for the details.



If you shoot without positioning the autofocus frame () on the main subject of the picture as shown above, only the background will be in focus. When the main subject of your picture is off the autofocus frame in the center of the viewfinder, use the focus-lock technique.

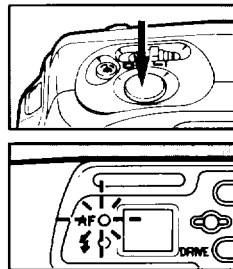

- 1** When taking a picture of two people, for example, first position the autofocus frame () on one of the two.
- 2** As you press the shutter release button half-way, the green lamp on the lefthand side of the viewfinder eye-piece glows, and focus and exposure are temporarily locked.

3



- 3 While pressing the shutter release button half-way, re-aim the camera or recompose the picture, then release the shutter.

Notes:

- You can cancel focus lock simply by taking your finger off the shutter release button.
- When in the Consecutive Shooting mode (), focus lock cannot be used.

Hard-to-autofocus subjects

Like many other autofocus cameras, this camera's autofocus system is highly precise, but is not almighty, so it may not focus as you wish on certain subjects. In such cases, use the focus-lock technique on a subject which is both near the actual one and equidistant from the lens.

Subjects which are hard to autofocus include:

1. Black objects like hair, which don't reflect much light (and therefore don't reflect infrared autofocus beams).
2. Wire netting, latticework, iron exercise-bars, etc.
3. Flickering light sources such as neon signs, fluorescent lamps, TV images, sunlight coming through trees, etc., and subjects illuminated by these light sources.
4. Glossy and reflective surfaces like glass, mirrors, car bodies, etc.
5. Fast-moving objects, like trains in motion.
6. Water jets, water surface, smoke, flame, fireworks, etc., which are formless.

8. UNLOADING FILM

(Be...

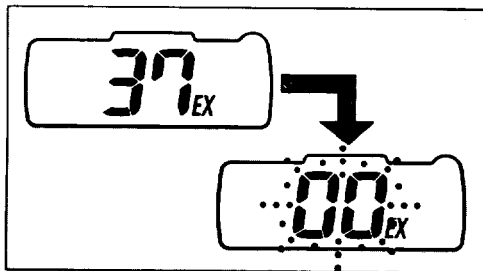

- 1 After you have exposed the last frame of the roll, film rewinds automatically. Then, the motor stops, and (00) flickers as shown to indicate end of rewind.

2

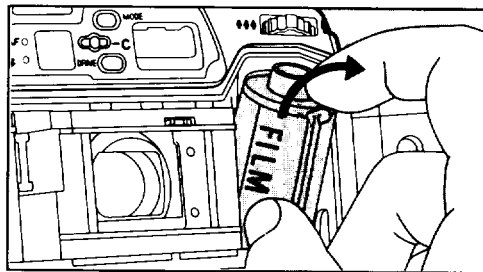

- 2 Open the back cover, and remove the cartridge from the chamber by pulling on its top with your fingertip as shown.

Notes:

- During rewinding, the exposure counter counts frame numbers in reverse.
- A 24-exposure film roll takes about 20 seconds to be rewound.
- The entire roll of film including the film leader is always rewound into the cartridge to avoid leakage of light onto any part of the film.

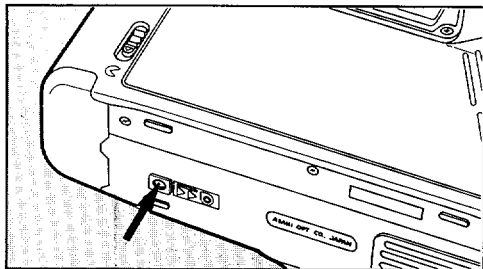

Rewinding the film in midroll

If you wish to unload the film before exposing all the frames, push the auxiliary rewind button with the protrusion ② of the strap's clamp; film rewinding starts. When rewind is completed, the motor stops, and (**00**) flickers.

Caution:

Never open the back cover until rewinding is completed.



TAKING MACRO PICTURES

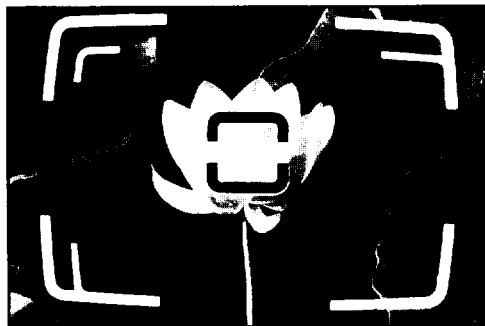







This shooting mode is used to take close-up pictures. When the macro symbol (🌸) appears on the LCD panel, you can take macro pictures. When shooting a subject about 0.6 meters (2 ft) away, compose the shot within the parallax-correction frame.

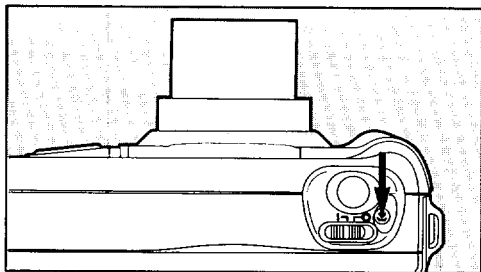

Effective Range: 0.6 — one meter/2 — 3.3 ft.)

1



- 1 Press the macro button () to engage the Macro mode, and the lens moves forward. To cancel the Macro mode, just move the zooming lever to the left (  ) or right (). The ordinary shooting mode is then restored.

Notes:

- When the autofocus frame () is off-center of the picture area in macro or close-range photography, use the techniques described in "Focus-lock shooting" on p. 14.
- The green lamp just glows when the camera-to-subject distance is extremely short (about 30 cm).

2

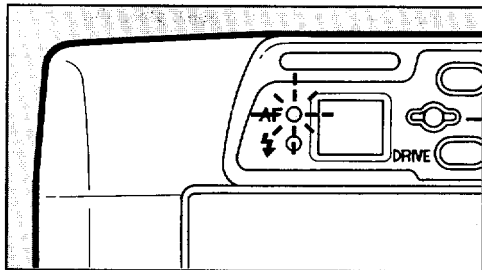

- 2 The macro shooting range is 0.6 — one meter (2 — 3.3 ft). Press the shutter release button half-way, make sure the green lamp glows, then release the shutter. If the camera-to-subject distance is more than one meter (3.3 ft), and the camera is in macro mode, the green lamp will flicker, and the shutter cannot be released. By taking your finger off the shutter release button, the macro mode is cancelled, and the ordinary shooting mode is restored. Now a distant subject (one meter/3.3 ft — infinity away) can be shot.

MODES

To select various exposure modes, press the **MODE** button ①

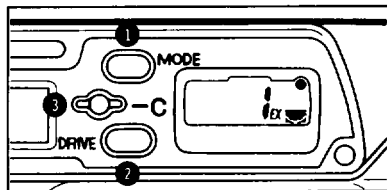
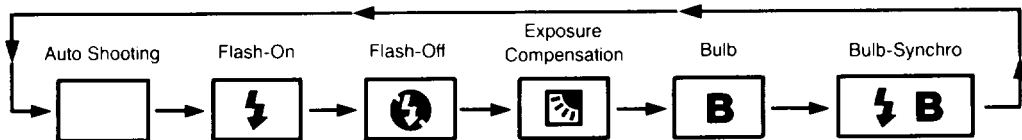

Press buttons ① and/or ② in succession to set the required modes. Normally, use the Auto and Single-Frame Shooting modes. To immediately restore these modes, press the clear () button ③

To select various drive modes, press the **DRIVE** button ②

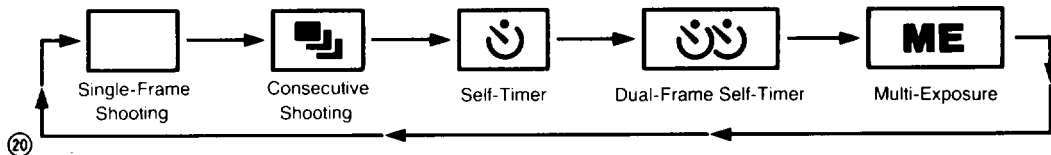

FLASH-ON (FORCED EMISSION)

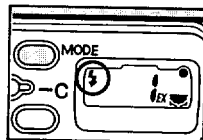

In this mode, the flash will always fire whether the subjects are in a bright or dark environment. Use this mode for Daylight-Synchro and Slow-Speed Synchro shooting.

Daylight-Synchro Shooting

In portrait photography, the subject is often darkened in the picture because the exposure is automatically set for a bright background. This happens when the subject is backlit, when there is a window behind the subject, and when the subject is shadowed by trees, etc. In such cases, use the Daylight-Synchro Shooting mode within the appropriate flash-effective range so that the subject and background are shot in beautifully balanced lighting.

Slow-Speed Synchro Shooting

As shown in the photograph at left, it's possible to expose both subject and background in a well-balanced way. Shutter speed gets slower up to 1/5 sec. to capture the background and flash fires for the main subject. Use a tripod in this mode to avoid camera shake.

Note:

- Make sure you're within the flash-effective distance range and that the flash (red) lamp glows before shooting.

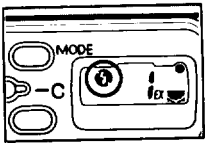
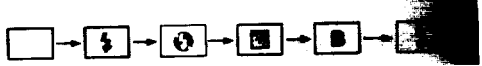

In this mode, the flash does not fire, and a picture is taken at a slower shutter speed. Use this in situations when flash photography is prohibited, such as in theaters, museums, etc.

Furthermore, this mode is also useful when you wish to take a soft-lighted picture with natural atmosphere.

Notes:

- When shooting in darkness, another indicator helps avoid underexposure. Press the shutter release button half-way; the Flash-On mode mark (⚡) on the LCD panel flickers to recommend use of the flash.
- When shooting in darkness, the shutter speed gets slower, and camera shake is more likely to blur your shot, so use a tripod.

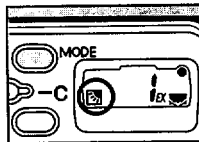

Portraits with a window, blue sky, or other bright background often result in underexposure because the exposure is automatically set for the background. Exposure Compensation makes good use of natural

lighting to improve the balance of light between the subject and the rest of the picture. Also use this mode to shoot scenery.

Notes:

- When using Exposure Compensation in a dimly-lit place, the shutter speed may be so slow that you should use a tripod to prevent camera shake.
- When shooting in darkness, a photograph will be underexposed. In such cases, press the shutter release button half-way; the Flash-On mode mark (⚡) on the LCD panel flickers to recommend use of flash.

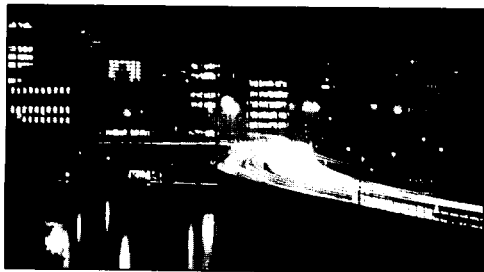

Bulb mode, approx. 7 sec. (ISO100).



Bulb-Synchro mode, approx. 2 sec. (ISO100).

Bulb mode (**B**)

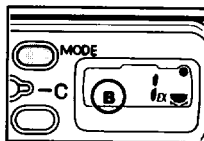

This mode is useful for long exposures required for shooting such things as fireworks and night scenes. The shutter remains open as long as the shutter release button is held down (but within the

range of 0.5 – 8 sec). When using this mode, the camera should be mounted on a tripod.

Bulb-Synchro mode (**⚡ B**)

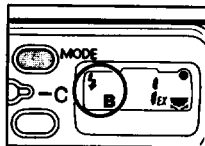

This lets you use the flash in addition to the Bulb mode, so you can take a portrait with a night scene in the background, for example.

Notes:

- The shutter stays open for a maximum of 8 seconds, even if you continue to press the shutter release button.
- The Self-Timer (**⌚**) or Dual-Frame Self-Timer (**⌚⌚**) cannot be used in combination with the Bulb or Bulb-Synchro mode.

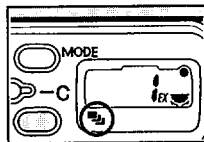
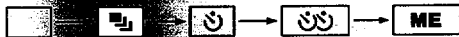

In this mode, keep pressing the shutter release button for consecutive shooting. Moving subjects such as a running person, etc., can be shot. The camera focuses on the subject frame by frame in this mode, so make sure to keep the autofocus frame () on the subject.



Note:

- When using the flash in this mode, consecutive shooting is possible only after the flash is charged (the red lamp glows) following each exposure.

SELF-TIMER

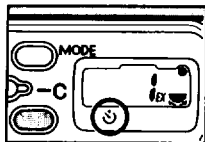

Use the Self-Timer when you wish to get yourself into the picture. Use of a tripod is recommended.

1

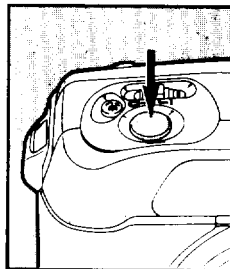

2

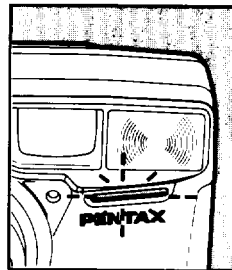

- 1 Focus on the subject first, and then depress the shutter release button. The shutter will be released in about 10 seconds.
- 2 When the Self-Timer is working, the Self-Timer mark (☺) flickers on the LCD panel, and the Self-Timer lamp glows. The lamp starts blinking 3 seconds before the shutter is released.

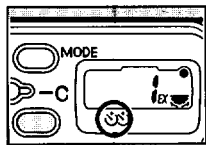
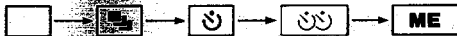

In this mode, you can take two self-timer pictures in quick succession.

Press the shutter release button. The first frame will be exposed after approx. 10 seconds, then the second

frame will be exposed approx. 5 seconds after the first. Note that focus for both shots is fixed in the first frame.

Notes on Self-Timer and Dual-Frame Self-Timer:

- To cancel the self-timer after it has been started, press the drive or mode button.
- To restore the Normal Auto and Single-Frame Shooting modes, press the clear button (**C**). This will also cancel the Self-Timer.
- When using flash with the Self-Timer or Dual-Frame Self-Timer mode, make sure the flash is charged (the red lamp glows) before operating either timer feature. When the battery mark () appears on the LCD panel, the camera may not operate. Replace the batteries (see page 34).
- Neither the Self-Timer nor Dual-Frame Self-Timer can be used with the Bulb or Bulb-Synchro mode.

MULTI-EXPOSURE



ME

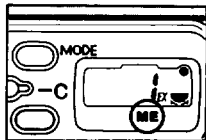

This mode allows you to multi-expose on the same frame.

1. Activate the Multi-Exposure mark (**ME**) on the LCD panel.
2. Press the shutter release button to shoot an initial exposure. The film will not advance, and the normal Single-Frame Exposure mode will be restored.
3. Recompose the frame, and press the shutter release button to shoot the second exposure. (After the second shot, the film will automatically advance to the next frame.)

To expose more than twice:

Activate the Multi-Exposure mark before pressing the shutter release button for the second exposure. After the last exposure, the film will wind to the next frame.

Notes:

- If you have a DATE model, the time and date data will also be multi-exposed, so set the data mode to no data (-----) after the first shot.
- Repeated multiple exposures tend to overexpose a frame, so it's recommended that you expose a frame just twice or so at most.
- When using Multi-Exposure, you can usually get best results with dimly-lit backgrounds, such as those in night scenes.

		EXPOSURE SYSTEM					
		(Auto)				B	
SHOOTING SYSTEM	(Single-Frame)						
						—	—
						—	—
	ME						

- : Normal
- : Combination possible
- : Combination impossible

As shown in the table above, exposure and shooting settings can be used in various combinations.

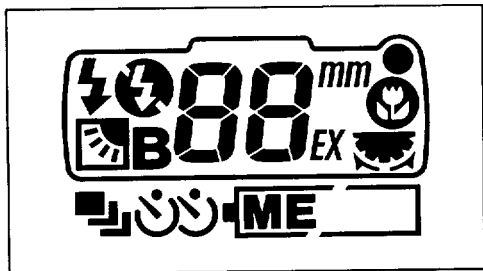

LCD Panel*

- : Shutter release button
When it goes out, the shutter cannot be released.
- : Zooming lever
When it goes out, zooming cannot be performed.

* All indications actually will not appear simultaneously as shown.

DATE MODEL

If you purchased
The DATE model

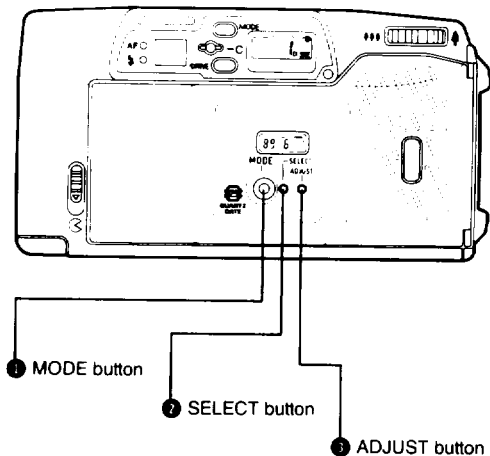

SETTING DATA

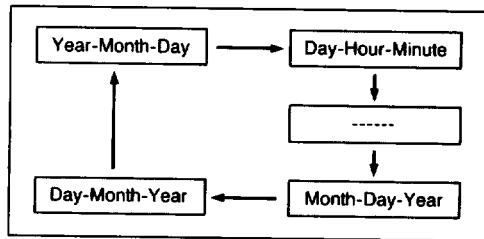

Switching the mode

Each time you press the MODE button ① with your fingernail, the mode in the LCD panel switches in succession from "Year-Month-Day" to "Day-Hour-Minute" to "-----" to "Month-Day-Year" to "Day-Month-Year". Stop pressing the button when the desired mode appears in the panel. "-----" indicates no data are imprinted.

Notes:

- "M" on the LCD panel indicates "Month".
- Use the strap clamp's pin-shaped protrusion to press the SELECT ② and ADJUST ③ buttons.

Correcting the data

- Each time you press the SELECT button ②, a different category of digits in the LCD display flickers. Press the SELECT button ② until you reach the flickering digit(s) which you wish to change. The digit(s) will move in the following order as you press the SELECT button ②.

Date: Year – Month – Day

Time: Hour – Minute – : (Second)

- Press the ADJUST button ③ to change digits of the specified category you chose with the SELECT button ②. Digits increase by one each time you press the ADJUST button ③. If you keep it depressed, the digit will advance continuously after a second or two.

- Date and time are indicated as follows:

Year = 87 – 19 (1987 – 2019)

Month = 1 – 12

Day = 1 – 31

Hour = 0 – 23

Minute = 00 – 59

Adjusting “Year-Month-Day”

1. Make the digit(s) to be changed corresponding to day, month, or year flicker by pressing the SELECT button ②.
2. Press the ADJUST button ③ to adjust the digit(s).
3. Press the SELECT button ② again to set the digit(s) you've changed and stop the flickering.

Adjusting “Hour-Minute-: (Second)”

1. Make the digit(s) to be changed corresponding to hour or minute flicker by pressing the SELECT button ②. The flickering “:” allows precise fine-tuning of the internal clock to the beginning of a specified minute.
2. Press the ADJUST button ③ to adjust the digit(s).
3. To adjust the time to the beginning of a minute, press the ADJUST button ③ in sync with a time-signal while “:” is flickering. “:” will stop flickering for an instant, and the minute will be set to its beginning.
4. Press the SELECT button ② again to set the digits you've changed and stop the flickering.

OPERATIONAL PRECAUTIONS

When shooting

- The data (Year-Month-Day or Day-Hour-Minute) is recorded on film as in the picture on the right. The data on the LCD panel is imprinted on each frame you expose.
- If the corner of the picture where the data is imprinted has a white or yellow object, the data will be difficult to see. When composing, try to avoid a brightly-colored subject in that corner.
- "Year-Month-Day" and "Day-Hour-Minute" cannot both be imprinted at the same time.
- As you release the shutter, the bar mark (—) on the LCD panel flickers for a few seconds, indicating the data has been imprinted.





Power source of the data-imprinting section

The data imprinting section is powered by the batteries in the camera's main unit. When the batteries are replaced, the date and time may change. So, after replacing the batteries, make sure to confirm the date and time before use.

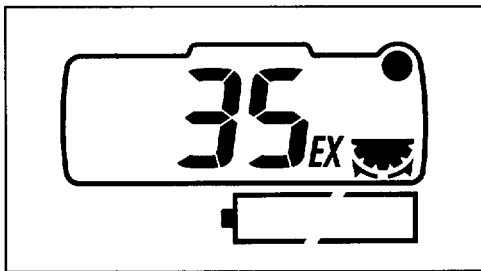
BATTERY EXHAUSTION WARNING





When the batteries are nearly exhausted, the battery mark () appears on the LCD panel to warn you. Replace the batteries as soon as possible. When () starts flickering, no operations can be performed.

The battery mark () appears during operation of the shutter release button or zooming lever.

Notes on replacing the batteries:

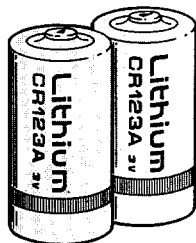
- Make sure there is no film loaded. Switch off power by setting the main switch to () before replacing the batteries.



- If the batteries are replaced with film already loaded, the camera enters the starting mode. It will assume the film has been just loaded and will advance several frames. (When the loaded film is near its end, () or (--) might appear on the exposure counter of the LCD panel. In such cases, press the auxiliary rewind button to activate rewinding.)
- Batteries power both the camera's main unit and the data-imprinting section. After replacement, confirm that the data on the LCD panel is correct.

Refer to page 31 for data correction.

Refer to page 34 for battery replacement.

REPLACING BATTERIES

Use two 3 V lithium batteries (CR-123A or DL-123A)

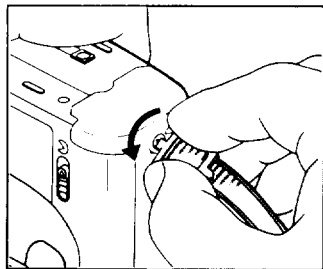

1 Using the screwdriver on the strap's clamp, rotate the screw on the battery chamber cover counterclockwise to open the cover.

2 Align the batteries with the (+) and (-) indications and insert two lithium batteries.

Caution:

Replace all batteries at the same time. Do not mix battery brands, types or old battery with new one. It may cause explosion or over heating.

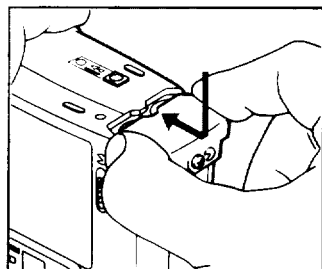
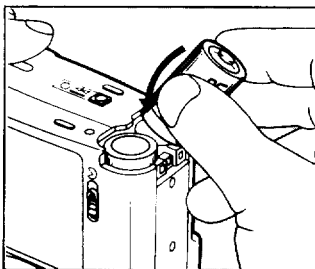

3 As illustrated, slide the battery chamber cover in the direction of the arrow while pressing down to close. Rotate the screw clockwise to fasten it securely. (When the battery chamber cover is reinstalled, the zoom lens and motor operate for a few moments.)

Note:

- When the batteries are incorrectly installed, (**EO**) will flicker on the LCD panel to warn you. Insert the batteries correctly.

PRECAUTIONS ON BATTERIES

- Use lithium CR-123A or DL-123A batteries.
- Keep the batteries out of the reach of children.
- The misuse of batteries causes hazards such as leakage, heating, explosions, etc. Batteries should be inserted with the (+) or (-) sides facing the correct direction.
- To prevent explosion, never try to break up or recharge the batteries, or throw exhausted ones into fire.

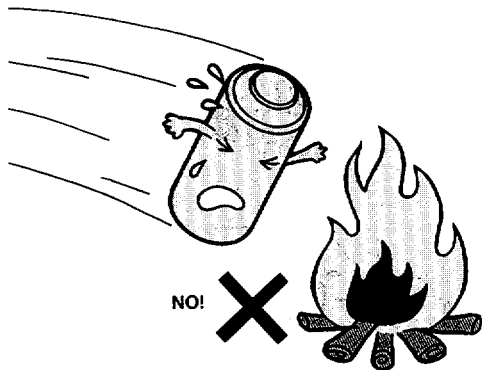

- Battery performance may temporarily decrease in low temperatures, but it will recover in normal temperature.
- Keep spare batteries on hand for convenience when shooting outdoors or while traveling.
- When the camera is in a bag, make sure the main switch is off; otherwise, battery power may be wasted with the accidental push of the shutter release button.

LCD (Liquid-crystal display)

- When the LCD is exposed to a high temperature of about 60°C, it may blacken, but when the temperature falls, it will return to normal.
- The LCD may also slow down in response to lower temperatures, but this is an LCD characteristic, not a defect.

Battery life (with 24-exposure film)

Normal photography	Approx. 125 rolls
When normal photography and flash photography are alternately performed	Approx. 30 rolls

(CR-123A battery used; based on our own test conditions)

TAKING CARE OF YOUR CAMERA

Your Pentax camera is a sophisticated, precision instrument built to give long-lasting, reliable service. It will serve you well if you handle and care for it properly.

Major causes of damage are:

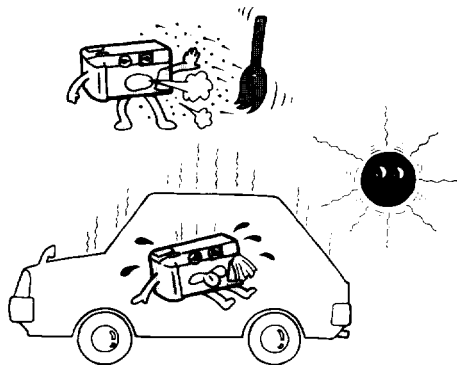
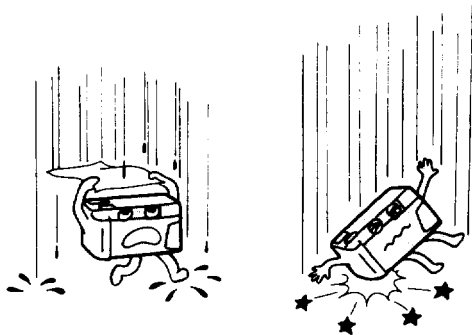

1. Dropping or banging the camera, which can damage it in many ways.
2. Water damage, particularly if the camera is submerged in salt water. Your camera is not water-proof! It must be protected from salty breezes or sprays at the beach, splashing of any kind, and rain. If your camera gets wet, wipe it dry immediately and have it examined at a Pentax service center.
3. Dirt and sand can cause serious damage to the shutter mechanism and other moving parts of the camera. Your camera needs periodic cleaning to keep it operating properly. Remove dirt and dust with lens-cleaning fluid, lens-cleaning tissues, etc. Never use solvents such as thinner or alcohol.



4. Avoid extremes of humidity and temperature. Keep your camera out of direct sunlight, car trunks, and glove compartments. Shooting outdoors in winter presents a problem since batteries won't function if they get too cold. In cold weather, carry your camera under your coat or jacket to keep the batteries warm. The temperatures at which this camera should function properly are approx. 50° — -10°C. Sudden changes in temperature will often cause condensation of moisture inside or on the outside of your camera. This might cause extremely damaging rusting of mechanisms. Furthermore, transferring the camera from a relatively warm to sub-freezing temperatures creates damaging ice or frost. Thus, sudden temperature changes should be avoided as much as possible. As a guide, a temperature change of 10°C should occur gradually over at least 30 minutes. If this is not possible, keeping the camera in its case or bag will help minimize the effects of a rapid temperature change.
5. Vibration from traveling in a car, plane, or ship can cause screws to loosen. To minimize this problem, line the bottom of your camera bag with inch-thick (2.54 cm) foam-rubber padding.
6. When mounting your camera on a tripod, make sure the tripod screw is no longer than 5.5 mm (0.22 in.), which is the depth of your camera's tripod socket. A longer screw might puncture the tripod socket, and damage the camera.
7. Do not place the camera with the zoom lens down without turning the main switch off; otherwise, the zooming mechanism may be seriously damaged.
8. The electric circuit inside this camera contains high voltage working parts. **NEVER ATTEMPT TO DISASSEMBLE.**

What appears troublesome might be easily remedied. Here are some problems and their remedies.

1. The shutter cannot be released.

- Is the main switch turned off ()? If so, turn it on (). (See page 3.)
- Are the batteries exhausted or are they loaded? Replace them or insert new batteries. (See page 34.)
- Is your subject out of the focusing range? Shoot in the range of one meter to infinity for ordinary photography and 0.6 to 1 meter for macro photography. (See pages 10, 12 and 18.)
- Are you operating the zooming lever? If so, release your fingers from the zooming lever, then shoot. (See page 13.)
- Is () flickering on the LCD panel? If so, the film is finished. Replace it with a new roll. (See page 16.)

2. My printed pictures don't look very clear.

- Did you position the autofocus frame () on your subject? (See pages 12 and 14.)
- Did you press the shutter release button gently while taking care not to obstruct the autofocus window with your fingers or hair? (See page 4.)

3. Zoom lens does not move.

- Are you continually pressing the shutter release button? If so, the zoom lens cannot operate. Take your finger off the shutter release button.

4. The zoom lens returned to the 35 mm position automatically.

- Did you leave the camera with the main switch on () and not operate it for over three minutes? If so, the camera retracted the lens to the 35 mm position to protect it. (See page 5.)

5. The flash-on mark ($\frac{1}{2}$) is flickering on the LCD panel.

- Did you just use the Flash-Off or the Exposure Compensation modes in a dark place? This is a warning against underexposure. You cannot take a good picture while this mark is flickering. (See pages 22 and 23.)

6. (E) is flickering on the LCD panel.

- Did you insert the batteries upside down? Reinsert the batteries correctly. (See page 34.)

7. There are red points on the eyes of subject in my picture.

- The RED EYE phenomenon occurs when the flash illumination reflects off the retina because the pupils open up in the dark. Although it is impossible to prevent it entirely, it can be minimized by lighting up the location up to about EV8 level, or by shooting in a close distance from the subject.

Do you know about film?

What is ISO?

ISO describes the sensitivity of film to light. The greater a film's ISO rating, the more sensitive it is. Usually, color negative film of ISO 100, 200 or 400 is used.

What is DX-coded film?

DX coding informs the camera of a film's ISO sensitivity, so the camera can self-adjust to the film's speed. Almost all negative-color film is DX-coded.

WARRANTY POLICY

All Pentax cameras purchased through authorized bona fide photographic distribution channels are guaranteed against defects of material or workmanship for a period of twelve months from date of purchase. Service will be rendered, and defective parts will be replaced without cost to you within that period, provided the equipment does not show evidence of impact, sand or liquid damage, mishandling, tampering, battery or chemical corrosion, operation contrary to operating instructions, or modification by an unauthorized repair shop. The manufacturer or its authorized representatives shall not be liable for any repair or alterations except those made with its written consent and shall not be liable for damages from delay or loss of use or from other indirect or consequential damages of any kind, whether caused by defective material or workmanship or otherwise, and it is expressly agreed that the liability of the manufacturer or its representatives under all guarantees or warranties, whether express or implied, is strictly limited to the replacement of parts as hereinbefore provided. No refunds will be made on repairs performed by non-authorized Pentax service facilities.

Procedure During 12-month Warranty Period

Any Pentax which proves defective during the 12-month warranty period should be returned to the dealer from whom you purchased the equipment or to the manufacturer. If there is no representative of the manufacturer in your country, send the equipment to the manufacturer, with postage prepaid. In this case, it will take a considerable length of time before the equipment can be returned to you owing to the complicated customs procedures required in Japan in importing and re-exporting photographic equipment. If the equipment is covered by warranty, repairs will be made and parts replaced free of charge, and the equipment will be returned to you upon completion of servicing. If the equipment is not covered by warranty, regular charges of the manufacturer or of its representatives will apply. Shipping charges are to be borne by the owner. If your Pentax was purchased outside of the country where you wish to have it serviced during the warranty period, regular handling and servicing fees may be charged by the manufacturer's representatives in that country. Notwithstanding this, your Pentax returned to



the manufacturer will be serviced free of charge according to this procedure and warranty policy. In any case, however, shipping charges and customs clearance fees are to be borne by the sender. To prove the date of your purchase when required, please keep the receipts or bills covering the purchase of your equipment for at least a year. Before sending your equipment for servicing, please make sure that you are sending it to the manufacturer's authorized representatives or their approved repair shops, unless you are sending it directly to the manufacturer. Always obtain a quotation of the service charge, and only after you accept the quoted service charge, instruct the service station to proceed with the servicing.

This warranty policy does not apply to Pentax products purchased in the U.S.A., U.K., or Canada. The local warranty policies available from Pentax distributors in those countries supersede this warranty policy.



Asahi Optical Co., Ltd. C.P.O. 895, Tokyo 100-91 JAPAN

Pentax Europe n.v. Weveldlaan 3-5, 1930 Zaventem, BELGIUM

Pentax Handelsgesellschaft mbH Postfach 54 0169, 2000 Hamburg 54, WEST GERMANY

Pentax U.K. Limited Pentax House, South Hill Avenue, South Harrow, Middlesex HA2 0LT, U.K.

Pentax France S.A. Z.I. Argenteuil, 12, Rue Ambroise-Croizat, 95100 Argenteuil, FRANCE

Pentax (Schweiz) AG Industriestrasse 2, 8305 Dietlikon ZH, SWITZERLAND

Pentax Scandinavia AB Box 650, S-751 27 Uppsala, SWEDEN

Pentax Nederland Spinveld 25, 4815 HR Breda, THE NETHERLANDS

Pentax Norge A.S. Cecilie Thoresens VEI, Lambertseter, 1101 Oslo 11, NORWAY

Pentax Corporation 35 Inverness Drive East, Englewood, Colorado 80112, U.S.A.

Pentax Canada Inc. 3131 Universal Drive, Mississauga, Ontario L4X 2E5, CANADA

Asahi Optical Brasileira Ind. e Com. Ltda. Rua Capitao Antonio Rosa 376, Sala 121 Ed. PBK, São Paulo, BRASIL

Free Manuals Download Website

<http://myh66.com>

<http://usermanuals.us>

<http://www.somanuals.com>

<http://www.4manuals.cc>

<http://www.manual-lib.com>

<http://www.404manual.com>

<http://www.luxmanual.com>

<http://aubethermostatmanual.com>

Golf course search by state

<http://golfingnear.com>

Email search by domain

<http://emailbydomain.com>

Auto manuals search

<http://auto.somanuals.com>

TV manuals search

<http://tv.somanuals.com>