



for your
precious moments

- PENTAX Corporation** 2-36-9, Maeno-cho, Itabashi-ku, Tokyo 174-8639, JAPAN
(<http://www.pentax.co.jp/>)
- PENTAX Europe GmbH**
(European Headquarters)
Julius-Vosseler-Strasse, 104, 22527 Hamburg, GERMANY
(HQ - <http://www.pentaxeurope.com>)
(Germany - <http://www.pentax.de>)
- Pentax U.K. Limited**
Pentax House, Heron Drive, Langley, Slough, Berks SL3 8PN,
U.K.
(<http://www.pentax.co.uk>)
- Pentax France S.A.S**
Pentax Benelux B.V
12/14, rue Jean Poulmarch, 95106 Argenteuil Cedex, FRANCE
(for Netherlands)
Spinveld 25, 4815 HR Breda, NETHERLANDS
(<http://www.pentax.nl>)
(for Belgium & Luxembourg)
Weiveldlaan 3-5, 1930 Zaventem, BELGIUM
(<http://www.pentax.be>)
- Pentax (Schweiz) AG**
Widenholzstrasse 1 Postfach 367 8305 Dietlikon,
SWITZERLAND
(<http://www.pentax.ch>)
- Pentax Scandinavia AB**
P.O. Box 650, 75127 Uppsala, SWEDEN
(<http://www.pentax.se>)
- PENTAX U.S.A., Inc.**
35 Inverness Drive East, Englewood, Colorado 80112, U.S.A.
(<http://www.pentax.com>)
- Pentax Canada Inc.**
3131 Universal Drive, Mississauga, Ontario L4X 2E5, CANADA
(<http://www.pentaxcanada.ca>)



The CE Mark is a Directive conformity
mark of the European Community
(EC).

This operating manual is printed on recycled paper.

57233

Copyright © PENTAX Corporation 2003

Downloaded from www.Manuals.com. All Manuals Search And Download.

PENTAX®

**ist*

OPERATING MANUAL

PENTAX®

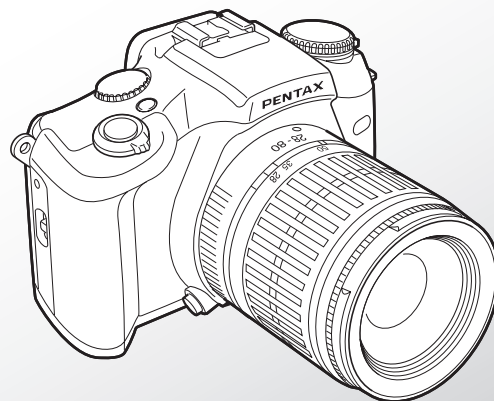

**ist*

OPERATING MANUAL

BASIC OPERATION
(PREPARATION)

BASIC OPERATION
(SHOOTING)

ADVANCED OPERATIONS

OTHERS

Congratulations on your purchase of this camera and welcome to the exciting world of Pentax autofocus photography! This compact and lightweight camera is an autofocus SLR camera that offers higher levels of sophistication and performance. Incorporating a broad range of advanced technologies and highly accurate automation, this camera will perform superbly for the most exacting photographer.

- Read this instruction manual carefully to get a full explanation of operations before use.

The camera does not operate when a lens with the following conditions attached.

Only FA J lens or the lens that has the **A** position can be used. The camera does not operate under the following conditions unless custom function [CF17] is changed to [2] (see pages 134 and 142):

- When a lens without an **A** position is used.
- When an F or FA lens is used and the aperture ring is set to a position other than the **A** position.
- When accessories such as an auto extension tube or auto bellows are used.

Lenses and accessories produced by other manufacturers are not made to meet our precise specifications and therefore may cause difficulties with, or actual damage to your Pentax camera. We do not assume any responsibility or liability for difficulties resulting from the use of lenses and accessories made by other manufacturers.

the manufacturer will be serviced free of charge according to this procedure and warranty policy.

In any case, however, shipping charges and customs clearance fees to be borne by the sender. To prove the date of your purchase when required, please keep the receipt or bills covering the purchase of your equipment for at least a year. Before sending your equipment for servicing, please make sure that you are sending it to the manufacturer's authorized representatives or their approved repair shops, unless you are sending it directly to the manufacturer. Always obtain a quotation for the service charge, and only after you accept the quoted service charge, instruct the service station to proceed with the servicing.

- **This warranty policy does not affect the customer's statutory rights.**
- **The local warranty policies available from Pentax distributors in some countries can supersede this warranty policy. Therefore, we recommend that you review the warranty card supplied with your product at the time of purchase, or contact the PENTAX distributor in your country for more information and to receive a copy of the warranty policy.**

FOR SAFE USE OF YOUR CAMERA

Although we have carefully designed this camera for safe operation, please be sure to follow precautions given on this page.



WARNING: This mark indicates precautions that, if not followed, could result in serious injury to the user.



CAUTION: This mark indicates precautions that, if not followed, could result in minor or medium injury to the user or damage to the equipment.



WARNING

- The electronic circuits inside the camera contain high voltage working parts. Never attempt to disassemble the camera yourself.
- Never touch internal parts of the camera if they become exposed from dropping the camera or for some other reason, as there is danger of an electric shock.
- Wrapping the strap around your neck is dangerous. Make sure that small children do not get the strap caught around their neck.
- Do not look directly at the sun through the camera, as viewing the sun may damage your eyes, and/or parts of the camera (e.g.: shutter curtains, etc.)
- Be sure to store batteries out of the reach of children. Seek medical assistance immediately if accidentally swallowed.



CAUTION

- Never try to disassemble, short or recharge the battery. Also, do not dispose of the battery in fire, as it may explode.
- Remove the batteries from the camera immediately if they become hot or begin to smoke. Be careful not to burn yourself during removal.
- Do not place your finger on the flash when it is discharging as there is a risk of burns.

PRECAUTIONS FOR YOUR CAMERA

Your Pentax camera is a high-precision mechanism. Handle it with great care.

Precautions when taking pictures

- Do not use the camera where it may come in contact with rain, water, or any other liquid, because the camera is not weather, water, or liquid resistant. Should the camera get wet from rain, splashing water, or any other liquid wipe it off immediately with a dry soft cloth.
- Do not drop the camera or allow it to hit solid objects. If the camera suffers a shock or impact, take it to a Pentax service center for inspection.
- Be careful not to subject the camera to strong vibrations, shock or pressure. Use a cushion to protect the camera when carrying it in a motorcycle, car, boat, etc.
- Condensation on the interior or exterior of the camera may be extremely harmful to the camera mechanism as it may cause rust. Furthermore, if the camera is taken from warm temperature to a subfreezing one or vice versa, the formation of icelets may cause damage. In such a case, put the camera into a case or plastic bag so that any changes in temperature difference is minimized. Do not remove it from the bag until temperature has stabilized.
- Regular size color prints may cut off what appears on the extreme edges of the film frame. Compose your picture with a margin of safety at the edges.

Precautions for storage

- Avoid leaving the camera for extended periods in places where the humidity and temperature are very high, such as in a car.
- Do not store the camera in a closet with moth balls or in an area where chemicals are handled. Store it in a place with good dry air circulation to prevent the growth of fungus.

Precautions for proper care

- Never touch the shutter curtain or mirror with your finger or any other object.
- Use a lens brush to remove dust accumulated on the lens or viewfinder.
- Never use a spray blower for cleaning as it may damage the lens.
- Never use solvents such as paint thinner, alcohol or benzene to clean the camera.

- Electrical problems may often be caused by water, dirt or dust at points of electrical contact. Also check for battery leakage, traces of dirt or grease, or corrosion due to salinity or gas. If you cannot correct the problems, have your camera inspected at a Pentax service center. Repairs of this nature are not covered under the terms of the warranty and charges may be assessed.

Other precautions

- The temperature range at which this camera functions properly is 50°C to -10°C (122°F to 14°F).
- A camera which has been submerged in water usually cannot be repaired. If such an accident should occur, it is advisable to contact a Pentax Service Center immediately.
- To maintain optimum performance, it is recommended that the camera be inspected every one or two years. If the camera has not been used for an extended period, or is being prepared for an important photographic session, it is recommended that you have the camera inspected or test shoot with it.
- Repairs deemed necessary due to usage of this product in an industrial or commercial application may not be covered under the terms of the Pentax warranty.
- The PENTAX warranty provides only for the repair of defects in materials or workmanship. Damage of any kind cannot be repaired at any charge under the terms of the warranty. If the difficulty is caused as a direct result of the product being used in conditions as outlined in the "Precautions for Your Camera" section or any other operation contrary to the instructions outlined in this manual, charges will be assessed and a repair quotation will be provided.

PRECAUTIONS FOR YOUR CAMERA

PRECAUTIONS FOR BATTERY USAGE

- Use two 3V lithium batteries (CR2 type).
- Misuse of the battery can cause hazards such as leakage, overheating, explosion, etc. The battery should be inserted correctly with regard to polarity (+ and -) marked on the battery and the camera.
- Battery performance may be temporarily hindered in low temperatures, but will recover in normal temperatures.
- Keep a spare battery on hand for replacement convenience when shooting outdoors or while traveling.
- If the built-in flash is used continuously, the battery may become warm, but it does not mean that the battery is faulty; it is one of the battery's characteristics.
- Replace the batteries at the same time. Do not mix battery brands, type or an old battery with a new one. It may cause explosion or overheating.

TABLE OF CONTENTS

FOR SAFE USE OF YOUR CAMERA	1
PRECAUTIONS FOR YOUR CAMERA	2
TABLE OF CONTENTS	5
NAMES OF WORKING PARTS	10
LCD PANEL INDICATIONS	12
VIEWFINDER INDICATIONS	14
QUICK AND EASY SHOOTING	15
CAMERA FUNCTIONS AVAILABLE WITH VARIOUS LENSES	18
HOW TO USE THIS OPERATING MANUAL	20

1

BASIC OPERATION (PREPARATION)

21

Step 1. ATTACHING THE STRAP	22
Step 2 LOADING THE BATTERIES	23
Low Battery Warning	26
Step 3 TURNING ON THE POWER	27
Step 4 ADJUSTING THE DATE AND TIME	28
Step 5 IMPRINTING THE DATE OR TIME	30
Step 6 ATTACHING A LENS	32
Step 7 ADJUSTING THE VIEWFINDER'S DIOPTRER	34
Step 8 LOADING FILM	35
Step 9 OPERATING THE SHUTTER RELEASE BUTTON	37

TABLE OF CONTENTS

2

BASIC OPERATION (SHOOTING)







39

Step 1. SETTING THE SINGLE FRAME DRIVE MODE	40
Step 2. SETTING THE AUTO PICTURE MODE	41
Step 3. SETTING MULTI (16)-SEGMENT METERING MODE	42
Step 4. SETTING THE AUTO FOCUS MODE TO AF.S	43
Step 5. SETTING THE FOCUS POINT MODE TO AUTO	44
Step 6. SETTING THE AUTO POP UP FLASH	45
Step 7. USING THE ZOOM LENS	46
Step 8. HOLDING THE CAMERA	47
Step 9. TAKING A PICTURE	48
Step 10. UNLOADING A FILM	50
Step 11. REWINDING A FILM IN MID-ROLL	51
SETTING THE FILM SPEED (ISO) MANUALLY	52

3

ADVANCED OPERATIONS

53

SELECTING A DRIVE MODE	54
Consecutive Shooting	55
Self-Timer Mode	56
Remote Control Shooting	59
Multiple Exposures on a Single Frame	61
AUTO BRACKETING	63
SELECTING THE PICTURE MODES	66
1.  Standard Program Mode	68
2.  Portrait Program Mode	69
3.  Landscape Program Mode	70
4.  Close-up Program Mode	71
5.  Action Program Mode	72
6.  Night-Scene Program Mode	73

SELECTING ANOTHER EXPOSURE MODE	74
Effect of Aperture and Shutter Speed	74
Using the Shutter-Priority AE Mode	76
Using the Aperture-Priority AE Mode	78
Using the Metered Manual Mode	80
Slow-Speed-Sync Mode	83
USING THE BULB EXPOSURE MODE	84
ABOUT EXPOSURE COMPENSATION	85
AE LOCK FUNCTION	86
TURNING OFF THE AUDIBLE PCV SIGNAL	87
SWITCHING THE METERING MODE	88
Using Multi(16)-Segment Metering	88
Using Center-Weighted Metering	89
Using Spot Metering	90
ABOUT FOCUSING	91
Using the AF Single Mode (AF.S)	92
Using the AF Continuous Mode (AF.C)	93
Manual Focusing	94
Selecting the Focus Point	96
Setting the Focus Point to the Center of the Viewfinder	97
Using the Focus Lock	98
Previewing the Depth of Field	100
Hard-to-Autofocus Subjects	101
Notes on Accessories	101
USING THE BUILT-IN FLASH	102
Auto Pop-up Flash Function	102
Selecting the Various Built-in Flash Modes	104
About Red-eye Phenomenon	105
Red-eye Reduction Flash Function	105
Flash Effective Range for the Auto Picture Mode and Picture Mode	105

TABLE OF CONTENTS

POP-UP THE BUILT-IN FLASH MANUALLY	106
Daylight-Sync Shooting	108
FLASH RECOMMENDED INFORMATION	109
INAPPROPRIATE LENS WARNING WHEN THE BUILT- IN FLASH IS USED	110
ADVANCED OPERATION FOR THE BUILT-IN FLASH	111
1. When Using the Auto Picture and Picture Modes	111
2. Shutter-Priority AE Mode	111
3. Aperture-Priority AE Mode	111
4. Metered Manual Mode	112
F, FA and FA J Lenses Compatibility with the Built-in Flash	114
USING EXTERNAL FLASH	116
Flash Functions	116
Using P-TTL Auto Flash Mode with the AF360FGZ	118
Using High-Speed Sync Flash Mode with the AF360FGZ	119
Wireless Flash (AF360FGZ Only)	121
Contrast-Control-Sync Flash	123
Using Both the Built-in Flash and External Flash	124
Red-eye Reduction Flash Function	126
Trailing-Shutter-Curtain Sync Flash	126
Multi-burst Flash with the Pentax Dedicated Flash	126

4

OTHERS

127

ACCESSORIES (OPTIONAL)	128
AA-Battery Grip BG-20	128
Cable Switch	128
Flash Accessories	129
Viewfinder and Lens Accessories	130
Camera Cases	131
Strap	131
About Polarizing Filter	131
CUSTOM FUNCTIONS	132
Basic Setting of Custom Functions	134
Setting the Custom Function	136
TROUBLESHOOTING	144
PROGRAM DIAGRAMS	146
SPECIFICATIONS TABLE	148
Specification for Remote Control (Optional)	150
WARRANTY POLICY	152



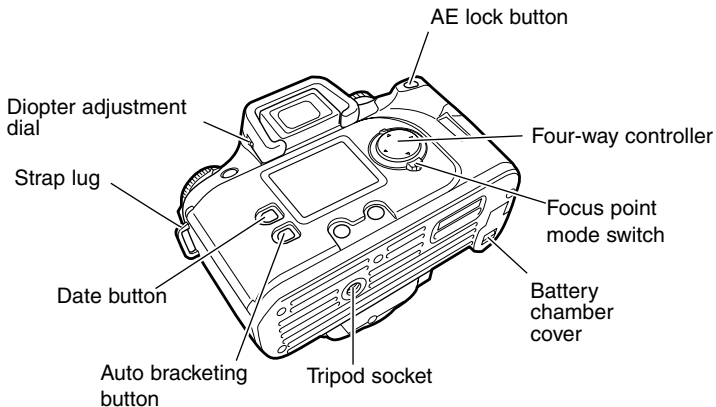
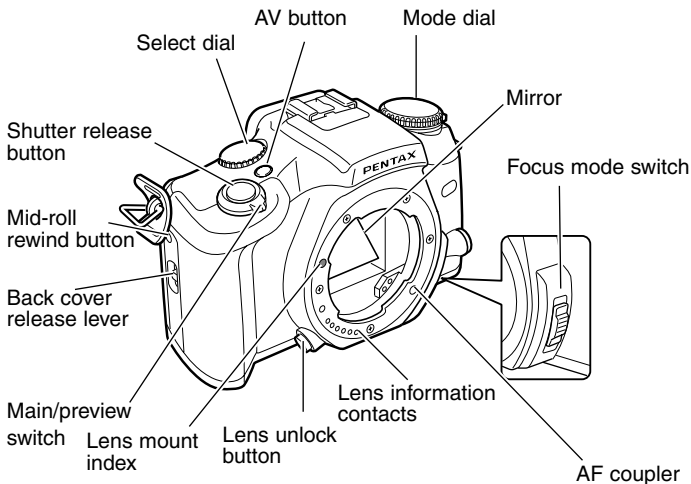

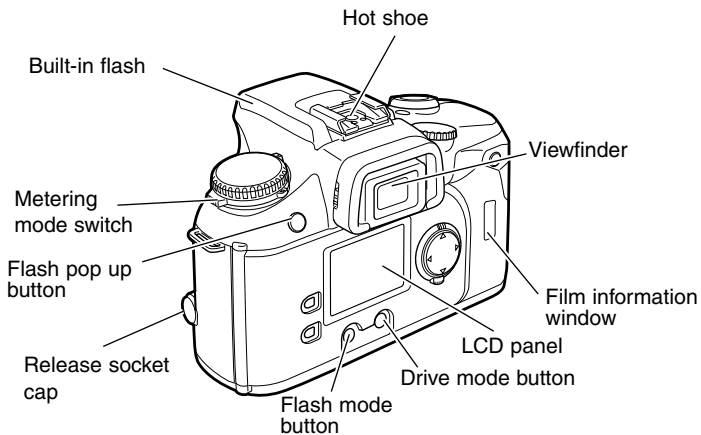



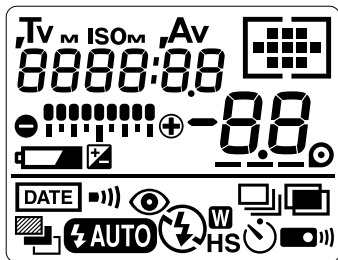





NAMES OF WORKING PARTS





LCD PANEL INDICATIONS



- Tv**
8888 : Shutter speed
ISO
8888 : Manual-set film speed
 (p. 52)
Av
88 : Aperture value
 : Focus points (p. 96, 97)
8888:88 : Date/time (p. 28 to 31)
 : Bar graph (p. 64, 81, 85)
 : Battery exhaustion
 warning (p. 26)
88 : Exposure counter
 (p. 36)
---  : Film status indication
 (p. 36, 50)
DATE : Date mode status
 indication (p. 29, 31)
 : Audible PCV signal (p. 87)
 : Auto bracket exposure
 (p. 63)
 : Exposure compensation
 (p. 85)
-  **AUTO** : Automatic flash
 indication (p. 45)
 : Red-eye reduction flash
 indication (p. 105)
 : Flash-off indication
 (p. 104)
 : Flash status indication
 (p. 102)
W : Wireless flash mode
 (p. 104, 121)
HS : High speed sync mode
 (p. 104, 119)
 : Consecutive shooting
 (p. 55)
 : Multiple-exposure
 shooting (p. 61)
 : Self-timer (p. 56)
 : Remote control release
 (p. 59)

 **MEMO**

- To see the LCD panel in the dark, turn the main/preview switch to . The LCD panel will light up for about 10 seconds. When the AF360FGZ is used, the LCD panel on the AF360FGZ will also light up.
- If you change custom function number [CF15] to [2], the LCD illuminates automatically under low light condition. You can turn off the illumination function by setting [CF15] to [3]. See pages 134 and 141.

VIEWFINDER INDICATIONS

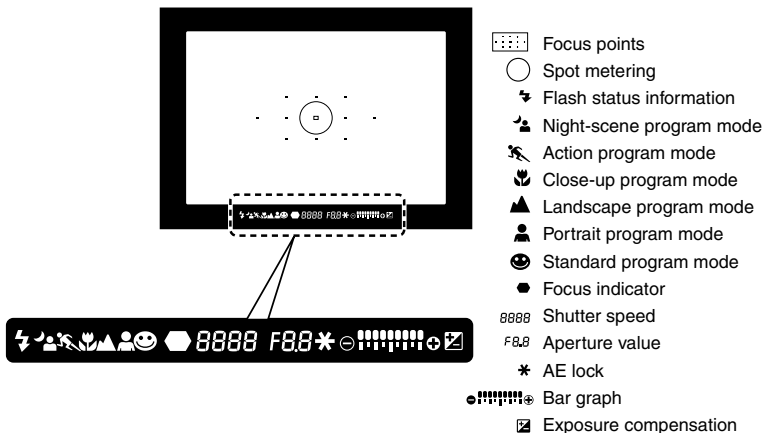

- Regular size color prints may cut off what appears on the extreme edges of the film frame. Compose your picture with a margin of safety at the edges.
- The frame number on the film will be upside down in relation to the picture. Keep this in mind when ordering copies of prints.

MEMO

- The selected focus point is superimposed in red (the surrounding area is also dimly lit) in the viewfinder when the shutter release button is pressed halfway down. The superimpose function can be canceled using the custom function [CF6]. See pages 134 and 138.

QUICK AND EASY SHOOTING

1 Load the batteries.

Open the battery chamber cover and load two CR2 Lithium batteries.

See page 23.

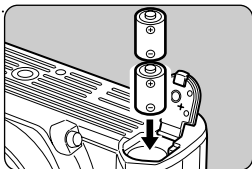

2 Set the date and time.

You can skip this step if you do not imprint the data at this time, but the date and time should be adjusted after loading the batteries.

See page 28.

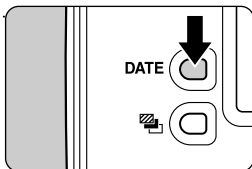

3 Attach the lens.

Align the red dots on the camera and lens mounts. Turn the lens to clockwise until it clicks in place.

See page 32.

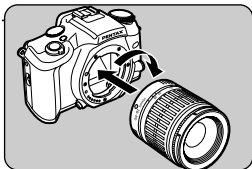

MEMO

- When using an F or FA lens, set the lens aperture ring to the **A** position while holding down the aperture-A lock button on the lens.

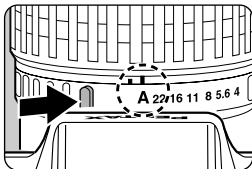

8 Set the autofocus mode.

Set the focus mode switch to

A.F.S

See page 43.

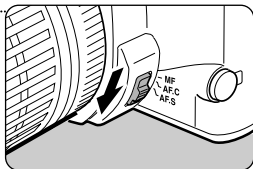

9 Compose the subject by turning the zoom ring.

See page 46.

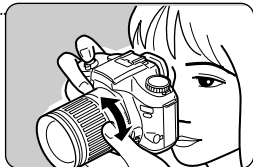

10 Adjust the focus and take a picture.

Focus on the subject through the focus points  and press the shutter release button to take a picture. When the shutter release button is pressed halfway down, auto flash pops up automatically if necessary.

See page 48.



CAMERA FUNCTIONS AVAILABLE WITH VARIOUS LENSES

Lenses that can be used with this camera

Only an FA J lens and an FA/F/A lens having an **[A]** position on the aperture ring can be used. Other lenses and an FA/F/A lens without an **[A]** position on the aperture ring cannot be used unless custom function number [CF17] is set to [2].

Function	Lens [Mount type]	FA J, FA lens [K _{AF} , K _{AF2}] ^{*3}	F lens [K _{AF}] ^{*3}	A lens [K _A]
Autofocus	(Lens only)	○	○	×
	(With AF adapter 1.7X) ^{*1}	—	—	○
Manual focus	(With the focus indicator) ^{*2}	○	○	○
	(With Matte field)	○	○	○
Eleven focus points		○	○	×
Power zoom		×	×	×
Auto Picture Mode, Picture Mode		○	○	○ ^{*4}
Aperture-Priority AE		○	○	○
Shutter-Priority AE		○	○	○
Metered Manual		○	○	○
TTL Auto Flash		○	○	○
Multi (16)-segment metering		○	○	○

Notes:

- : Functions can be used only when the aperture ring is set to the **[A]** position.
 - ×
- × : Functions cannot be used.

- *1. Lens with a maximum aperture of f/2.8 or larger (smaller aperture number), and with its aperture ring set to the **[A]** position.
- *2. Lens with a maximum aperture of f/5.6 or larger (smaller aperture number).
- *3. To use an F/FA soft 85mm f/2.8 lens or FA soft 28mm f/2.8 lens, set custom function number [CF17] to [2]. Pictures can be taken with the aperture you set.
- *4. Only the standard program mode works in the Auto picture mode.

MEMO

K_{AF2} and K_{AF} mount lenses are designed to work with the Autofocus SLR camera.

Lenses and accessories that cannot be used with this camera

Only FA J lenses or lenses that have the **[A]** position on the aperture ring can be used. The camera does not operate under the following conditions unless custom function number [CF17] is changed to [2] (see pages 134 and 142):

- When a lens without an **[A]** position is used.
- When an F or FA lens is used and the aperture ring is set to a position other than the **[A]** position.
- When accessories such as an auto extension tube or auto bellows are used.

HOW TO USE THIS OPERATING MANUAL

This manual is organized into the following sections.

1**Basic Operation (Preparation)**

→Page 21

2**Basic Operation (Shooting)**

→Page 39

3**Advanced Operations**

→Page 53

4**Other information**

→Page 127

If you'd like to start taking pictures with this new camera as soon as possible, read sections 1 and 2, "BASIC OPERATION (PREPARATION)" and "BASIC OPERATION (SHOOTING)". These sections introduce only the basic functions of the camera.

More information that is detailed can be found in the section 3 and section 4.

1

BASIC OPERATION (PREPARATION)

- Step 1.** ATTACHING THE STRAP22
- Step 2.** LOADING THE BATTERIES23
- Step 3.** TURNING ON THE POWER27
- Step 4.** ADJUSTING THE DATE AND TIME28
- Step 5.** IMPRINTING THE DATE OR TIME30
- Step 6.** ATTACHING A LENS32
- Step 7.** ADJUSTING THE VIEWFINDER'S DIOPTER 34
- Step 8.** LOADING FILM35
- Step 9.** OPERATING THE SHUTTER RELEASE
BUTTON37

ATTACHING THE STRAP

- 1** Pass the end of the strap through the strap lug from underneath, then pass the strap through the clasp from underneath.

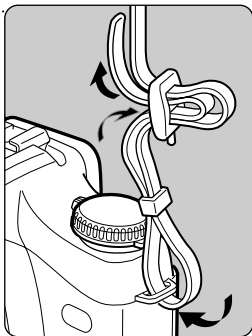

- 2** Pass the other end of the strap through the protection cover and triangular ring, then pass the strap through the clasp from underneath.

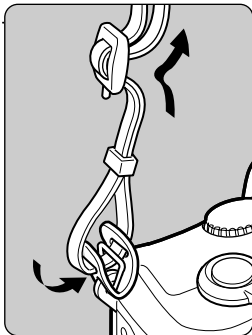

MEMO

- The strap's clasp can be used to rewind the film in mid-roll or to alter the date or time. Position the clasp away from the camera body.

LOADING THE BATTERIES

- 1** Open the battery chamber cover by pushing the lever as shown in the illustration.

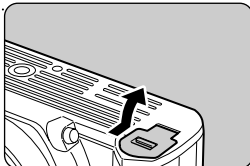

- 2** Load two lithium CR2 batteries or equivalent into the battery chamber with the batteries' positive (+) contacts pointing up.

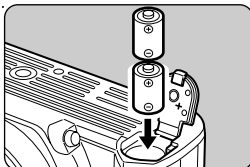

- 3** Push in the battery chamber cover firmly until it clicks in place.

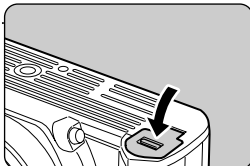

MEMO

- If the batteries are removed, the time will be re-set to 0:00 and the data setting will be initialized to [---- --] (no data imprinted). See page 28 for adjusting the date and time.
- The camera memorizes only the exposure number and date when the batteries are removed.

LOADING THE BATTERIES

MEMO

- Be sure to use two lithium CR2 batteries.
- The camera and date imprinting will not operate without batteries.
- The optional "Battery Grip BG-20" is also available for this camera to use four alkaline batteries.
- Replace the two batteries at the same time. Do not mix battery type, brands or an old battery with a new one.
- Keep spare batteries on hand for replacement convenience when shooting outdoors or while traveling.

Default settings after replacing the batteries

- When the batteries are replaced, the date mode will be re-set and the following camera settings will take effect.
All other settings will remain unchanged.

Built-in flash	Auto pop-up flash
Red-eye reduction flash	Off
Wireless flash sync	Off
High speed sync flash	Off
Drive mode	Single-frame
Audible PCV signal	On
Time	0:00
Imprinted date/time	Off

Battery Life(using 24-exposure film rolls at 20°C/68°F)

General existing light photography	About 50 rolls
Flash photography (using flash 50% of the times)	About 17 rolls
Flash photography (using flash 100% of the times)	About 12 rolls
Bulb exposure time	About 5 hours

Battery Life(using 24-exposure film rolls at -10°C/14°F)

General existing light photography	About 30 rolls
Flash photography (using flash 50% of the times)	About 10 rolls
Flash photography (using flash 100% of the times)	About 5 rolls
Bulb exposure time	About 1 hours

The above table is based on Pentax measuring conditions and may vary depending on shooting conditions.

MEMO



- New CR2 batteries were used under Pentax testing conditions.
- Actual battery life and performance may vary drastically depending on usage of autofocus, built-in flash and external conditions such as temperature and freshness of the batteries.
- Generally battery performance is temporarily deteriorated as temperature decreases. When the camera is used in a cold environment, keep this product warm by holding it in some protection against cold. Battery performance once deteriorated due to low temperature will be recovered when the batteries are returned to room temperature.
- See page 128 regarding battery life when "Battery Grip BG-20" is used.

Low Battery Warning

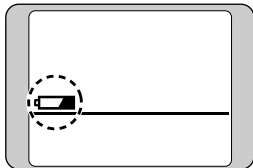
When the batteries are nearly exhausted, the low battery symbol  appears on the LCD panel to warn you. Replace the batteries as soon as possible.



MEMO

- See page 23 for replacing the batteries.
- Even if the low-battery symbol appears, exposure will be correct as long as the shutter can be released. It is recommended that you replace the batteries as soon as possible.
- When the low battery warning  starts blinking, the shutter cannot be released and no indication appears in the viewfinder.
- If the camera has not been used for a long time, the LCD panel may still display the low battery warning  even with a new set of batteries. In this situation, turn off the camera then turn it on and press the shutter release button halfway down. When the low battery warning  turns off, you can continue using the camera.

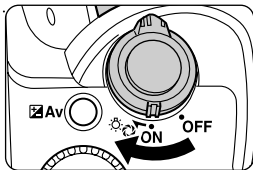

TURNING ON THE POWER

- 1 Turn the power ON.
Turn the main/preview switch to ON.



- Turn the power OFF.
Turn the main/preview switch to OFF.

MEMO

- Be sure to turn the main/preview switch off to prevent accidental battery drain when not in used.
- If  appears on the LCD panel, the batteries are nearly exhausted. Replace the batteries with new ones.
- If you remove the batteries, you need to adjust the time. Do not remove the batteries unless the batteries are low or exhausted.
- The LCD panel will be illuminated for about 10 seconds after turning the main/preview switch to the  position.
- The depth of field can be checked in the viewfinder by turning the main/preview switch to the  position. See page 100 for previewing the depth of field.
- If you change custom function number [CF15] to [2], the LCD illuminates automatically in low light condition. You can turn off the illumination function by setting [CF15] to [3]. See pages 134 and 141.

ADJUSTING THE DATE AND TIME

- 1** Turn the power ON and press the DATE button to display date mode on the LCD panel.

The display changes from TV/AV to the date mode.

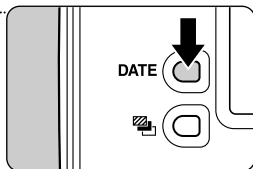

- 2** Keep pressing the DATE button for 3 seconds on the date mode display, the "year" digits will start to blink.

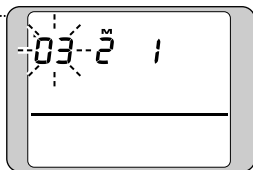

- 3** Each time the DATE button is pressed, the blinking digits change in the following order: Year-Month-Day-Hour-Minute-: .

Select the desired digits.

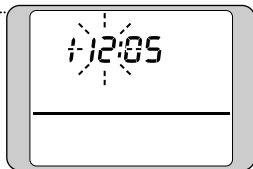

- 4** Turn the Select dial right or left to change the digits to change the blinking digits.

The digits increase by one each time the select dial is turned right and the digits decrease when turned to left.

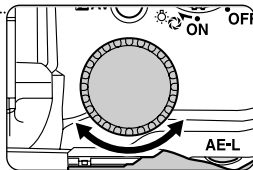

5 After you have changed the digits, press the DATE button to confirm them and adjust the next digits.

When you have changed the minutes, press the DATE button to start the clock and return the LCD panel to the AV/TV display.

6 Press the DATE button to select the date mode you wish to imprint on your pictures.

Confirm that **DATE** is displayed on the LCD panel.

See Page 30 for details.

MEMO

- Be sure to set the date and time after you load the batteries.
- If you replace the batteries, the time is reset to 0:00. Be sure to set the time. The date remains the same as when the batteries were removed.

Operational precautions

- The working temperature for data printing is -10°C – 50°C (14°F – 122°F).
- If high-speed film with an ISO rating of 1000 or faster is used, the imprinted characters may blur.
- If film with ISO rating of 50 or slower is used, the imprinted characters may be dark or dim.
- If you release the shutter while the data is blinking, the data cannot be imprinted.

IMPRINTING THE DATE OR TIME

- 1 Press the DATE button.**
The current date appears on the LCD panel.

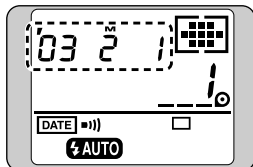
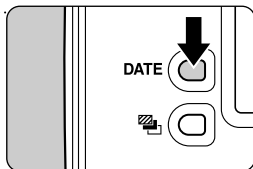

- 2 While the date mode is displayed, press the DATE button to select the date style you want to imprint on your pictures.**

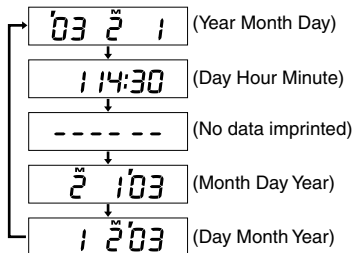
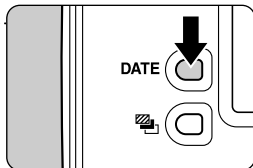

3 Press the shutter release button halfway, or turn the select dial, to return the LCD panel to the TV/AV display.

If you have chosen any date mode other than [---- --], **DATE** appears on the LCD panel.

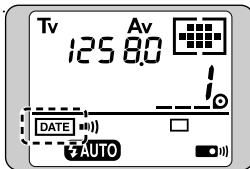

MEMO

- [M] on the LCD indicates "Month".
- Selected date mode will be imprinted.
- "03" imprinted on pictures indicates the year 2003.
- [---- --] indicates that no data will be imprinted.
- If there is a white or yellow object in the right bottom corner of the picture where the data is imprinting, the data may be difficult to read.
- Two 3V lithium batteries supply power for both the camera and the date functions. If the camera batteries are removed or replaced, the time and data mode will be reset to 0:00 and [---- --] (no data imprinted) respectively. You need to adjust the date and time then select the imprinting date mode.
- The data is not properly imprinted on the frame whose number is over the maximum number specified by the film.

ATTACHING A LENS

- 1** Remove the body mount cap **①** and rear lens cap **②** .

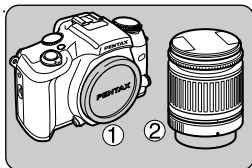

- 2** Align the red dots on the lens and camera while attaching the lens to the camera, then turn the lens clockwise until it clicks in place.

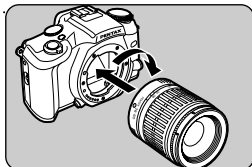

- 3** As shown in the illustration, remove the front lens cap.

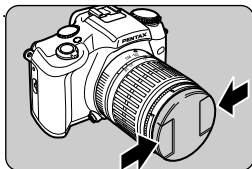

- 4** To detach the lens, hold down the lens unlock button and turn the lens counterclockwise.

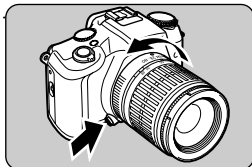

 **MEMO**

- The body mount cap protects the inside of the camera from dust and scratches upon factory shipment. For long-term camera storage, the optional accessory "Body Mount Cap K" is available.
- After attaching the lens, try to turn the lens counterclockwise to make sure it is locked in place.
- The camera body and lens mount incorporate lens information contacts and an AF coupler. Dirt, dust, or corrosion may cause damage to the electrical system. Clean the contacts with a soft and dry cloth.
- We assume no responsibility nor liability for damages resulting from the use of lenses made by other manufacturers.
- To protect the lens information contacts and AF coupler of the lens against damage after removal, be sure to place the lens down with the mount side upward.

ADJUSTING THE VIEWFINDER'S DIOPTER

- 1 Look through the viewfinder and point the camera to a well-lit scene. Then turn the diopter adjustment dial until the indications such as focus points  and TV/AV displays in the viewfinder look sharp.

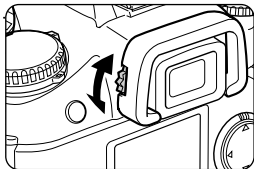

MEMO

- The diopter can be adjusted from -2.0 to $+1.0\text{m}^{-1}$ (per meter).

LOADING FILM

- 1** To open the back cover, slide up the back cover release lever in the direction of the arrow.

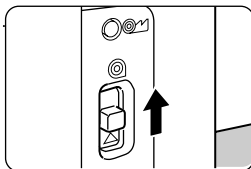

- 2** Place the film cartridge in the film chamber as shown in the illustration.

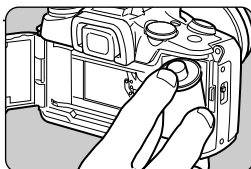

- 3** Pull the film leader out far enough to reach the take-up spool.
Be careful not to touch the shutter curtains.

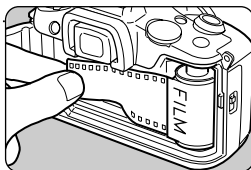

- 4** Align the film leader with film leader end mark (orange colored) and make sure that the film leader is positioned under the film retainer as shown in the illustration.

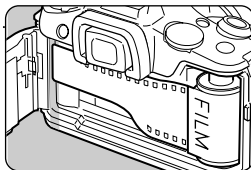

LOADING FILM

5 Close the back cover and turn the main switch to ON.

The film will advance to frame 1 automatically and the LCD panel will display the exposure counter 1 and film status information.

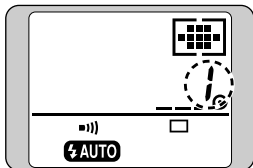
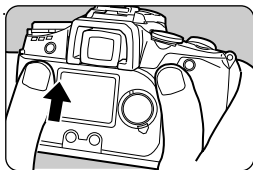

6 If the film is not loaded properly, \square blinks on the LCD panel. Open the back cover and load the film again.

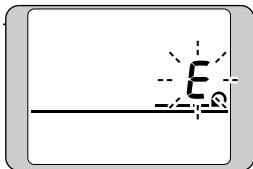

MEMO

- We suggest that you first operate the camera with no film loaded to become familiar with its operations.
- Always load and unload the film in the shade or avoid direct sunshine.
- The shutter curtains are made from fine precision material. Do not touch them with your fingers or any other object while loading the film.
- Automatic film speed setting
When DX-coded film is used, the correct film speed is automatically set for the camera. If you use a non-DX coded film, you can set the film speed manually. See page 52.
- Infrared film cannot be used. This camera uses infrared rays to detect film transport so infrared film may be exposed.

OPERATING THE SHUTTER RELEASE BUTTON

The shutter release button has two positions. Pressing it down halfway (first position) turns on the exposure meter, the LCD displays and autofocus system operates.

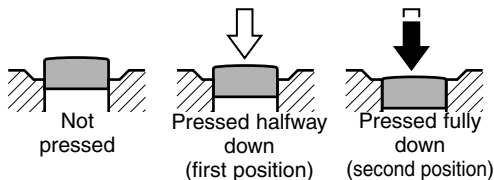

Pressing it fully (second position) releases the shutter. When taking a picture, press the shutter release button gently to prevent camera shake.

MEMO

- Before loading a roll of film, slowly press the shutter release button to learn where the first position is.
- The LCD indication stays on for about 10 seconds after the button is released from the halfway position. Pressing the shutter release button halfway down keeps the LCD indicator on.

2

BASIC OPERATION (SHOOTING)

Step 1. SETTING THE SINGLE FRAME DRIVE MODE . . .	40
Step 2. SETTING THE AUTO PICTURE MODE . . .	41
Step 3. SETTING MULTI(16)-SEGMENT METERING MODE	42
Step 4. SETTING THE AUTO FOCUS MODE TO AF.S	43
Step 5. SETTING THE FOCUS POINT MODE TO AUTO	44
Step 6. SETTING THE AUTO POP UP FLASH	45
Step 7. USING THE ZOOM LENS	46
Step 8. HOLDING THE CAMERA	47
Step 9. TAKING A PICTURE	48
Step 10. UNLOADING A FILM	50
Step 11. REWINDING A FILM IN MID-ROLL	51
SETTING THE FILM SPEED (ISO) MANUALLY . . .	52

SETTING THE SINGLE FRAME DRIVE MODE

- 1** Press the drive mode button until  appears on the LCD panel.

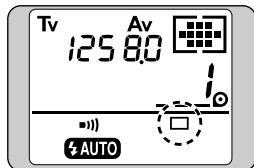
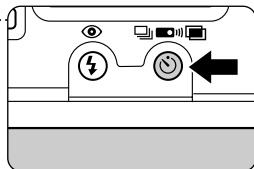

MEMO

- One picture is taken each time the shutter release button is pressed.
- The drive mode can also be set to consecutive shooting mode, self-timer mode, remote control shooting mode, multiple-exposure shooting mode or auto bracketing. See page 54.

SETTING THE AUTO PICTURE MODE

This Auto picture mode allows you to take pictures by simply pressing the shutter release button. The camera automatically selects one of the picture modes depending on the camera-to-subject distance and image magnification.

1 Set the mode dial to the **AUTO PICT** .

The selected picture mode appears in the viewfinder. In the Auto picture mode, the camera automatically selects one of 5 picture modes (standard ☺, portrait 👤, landscape ▲, close-up 🌸 and action 🏃) according to the requirement of the scene.

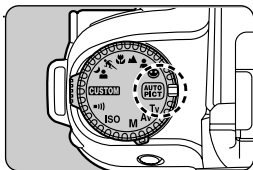

When "standard" is selected

MEMO

- When using an F or FA lens, set the lens aperture ring to the **A** position while holding down the aperture-A lock button on the lens.
- The Auto picture mode operates only when an FA J, FA or F lens is attached. When an A lens is attached, the exposure mode is automatically fixed to standard ☺ .

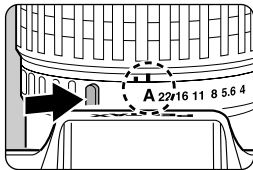

Step 3

SETTING MULTI (16)-SEGMENT METERING MODE

This metering mode automatically measures light in 16 different zones, enabling proper exposure value in a wide variety of normal and backlight conditions.

- 1 Set the metering mode switch to .

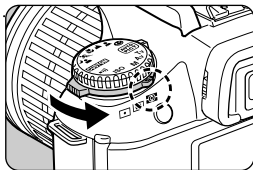

MEMO

- The center-weighted metering and spot metering are also available. See page 89 and 90.

SETTING THE AUTO FOCUS MODE TO A.F.S

When the shutter release button is pressed halfway down, the lens adjusts focus automatically.

- 1 Set the focus mode switch to **A.F.S** .

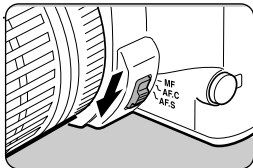

MEMO

You can also focus in the following ways:

- MF: Focus manually. See page 94.
- A.F.C: Continuous focus. See page 93.

See page 91 to 101 for various focusing methods.

Step 5

SETTING THE FOCUS POINT MODE TO AUTO

When the focus point mode is set to [AUTO], the camera selects one of the 11 focus points to focus even when the subject is not at the center.

1 Set the focus point mode switch to .

The focus area in the viewfinder is covered with the 11 focus points.

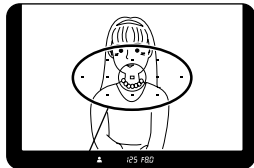
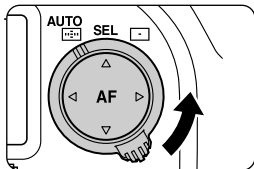

Focus area

MEMO

- You can also manually select one of the 11 focus points to focus on the subject, or fix the focus point in the center of the viewfinder. See pages 96 and 97.
- The focused point is superimposed in red on the viewfinder when the shutter release button is pressed halfway down. The superimpose function can be canceled using the custom function [CF6]. See pages 134 and 138.

SETTING THE AUTO POP UP FLASH

- 1** Press the flash mode button until **⚡AUTO** appears on the LCD panel.

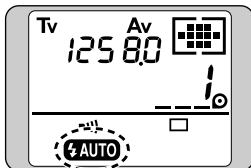
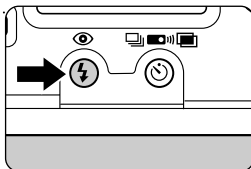

- 2** In this mode, the built-in flash automatically pops up when pressing the shutter button halfway down in the low light or backlight conditions.

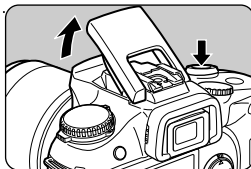

MEMO

- The built-in flash does not retract automatically except when you turn off the power, push the built-in flash down after use.
- If the flash pop up button is pressed after the flash popped up automatically, **⚡AUTO** disappears and the camera turns into the flash on mode.
- The auto pop up flash can only be selected in the auto picture mode and picture mode.
- The built-in flash does not discharge when not required even if it is in the up position. See page 102 for more details.
- Do not use a lens hood when the built-in flash is used, as it may obstruct the path of the light coming from the flash, causing vignetting in the picture corners.

Download from www.Somanuals.com. All Manuals Search And Download.

USING THE ZOOM LENS

- 1** Turning the zoom ring to the right makes the subject appear larger (telephoto) and turning it to the left makes the subject appear smaller (wide angle).

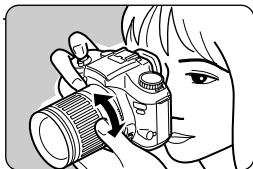

MEMO

- The smaller the number shown on the zoom scale ring, the wider the angle. Conversely, the larger the number, the more magnified the image appears.
- The Image Size Tracking Mode, Zoom Clip Mode, Auto Zoom Effect Mode and Power Zoom function do not operate with this camera even if an FA lens is attached.



Telephoto



Wide angle

HOLDING THE CAMERA

- Hold the camera firmly, with your left hand supporting the camera and lens as shown in the illustrations.
- While taking a picture, gently press the shutter release button. Sudden force on the shutter release button will cause camera shake, making the picture blurred.

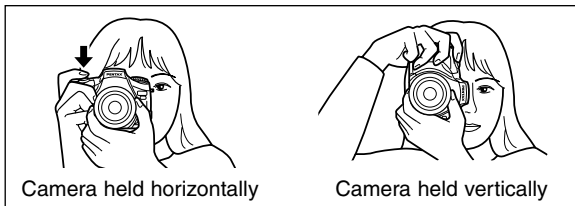



MEMO

- To reduce camera shake, support your body or the camera on a solid object - a table, tree, or a wall for instance.
- When using an telephoto lens, a tripod that is heavier than the total weight of the camera and lens is recommended to avoid camera shake.
- Although there are individual differences among photographers, in general the shutter speed for a hand held camera is the inverse of the focal length. For example, 1/50 of second for focal length is 50mm, and 1/100 of second for it is 100mm. A tripod should be used for shutter speeds slower than this.

TAKING A PICTURE

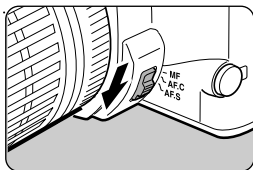
- 1** Confirm that the focus mode switch is set to **AF.S** and select the data mode to imprint or not.



- 2** Look through the viewfinder and frame the subject with the focus points . Then press the shutter release button halfway down.

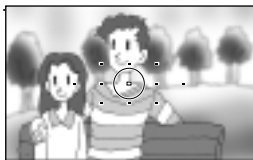

The lens adjusts focus automatically. When the subject is in focus, the focus indicator  in the viewfinder lights up.

The focus indicator  blinks when the camera is unable to obtain proper focus due to the following reasons.

1. The subject is too close. Adjust the camera-to-subject distance.
2. The subject is difficult to be focused. See "Hard-to-Autofocus Subjects" on page 101.



- 3** Confirm that the shutter speed, aperture value and picture mode in the viewfinder or on the LCD panel.

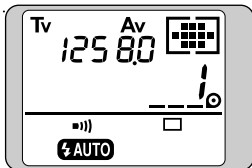

- 4** Take a picture.
Gently press the shutter release button completely.
The built-in flash pops up automatically when the subject is not lighted adequately.

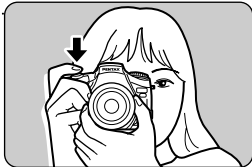

MEMO

- When using an F or FA lens, set the lens aperture ring to the **A** position while holding down the aperture-A lock button on the lens.
- The shutter cannot be released in the A.F.S mode if the subject is out of focus.
- Press the shutter release button halfway down. While  lights on, the camera-to-subject distance is fixed (Focus lock). To re-focus on another subject, lift your finger off the shutter release button then press it halfway again.

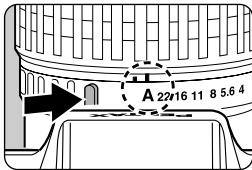

UNLOADING A FILM

1 The film automatically rewinds at the end of the roll.

During rewinding,  blinks on the LCD panel, indicating that the film is being rewound, the exposure counter counts frame numbers in reverse.

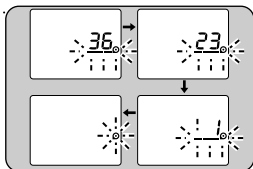

2 When the film is fully rewound, blinks on the LCD panel.

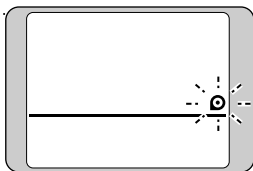

3 Open the back cover and remove the film.

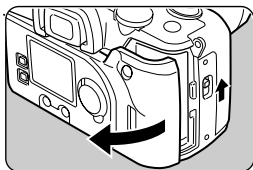

MEMO

- When removing the film from the camera, avoid direct sunlight.
- A roll of 24-exposure film takes about 13 seconds to rewind.
- Before opening the back cover, check that  is blinking.
- The shutter may be released a frame or more after the specified number of frames have been used as indicated on the film cartridge. However, those extra frames may be lost in processing. When you take important pictures, rewind the film when the film reaches the number of frames indicated on the film cartridge (see page 51) and load a new film.
- If the custom function [CF10] is set to [2], the film is not automatically rewound. See pages 134 and 139.

REWINDING A FILM IN MID-ROLL

If you wish to unload the film before exposing all the frames, use this function.

- 1 Turn the main/preview switch to ON, then use the strap clasp's protrusion to press the mid-roll rewind button.**

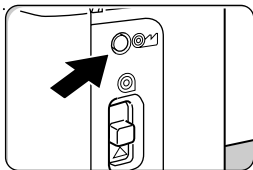

- 2 Rewind starts. When the film is fully rewound,  blinks on the LCD panel.**

- Before opening the back cover, check that  is blinking, and the exposure counter disappears from the LCD panel.

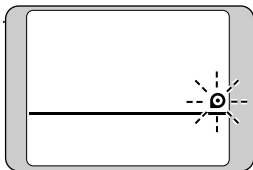

- 3 Open the back cover and remove the film.**

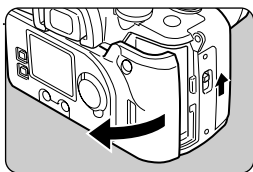

SETTING THE FILM SPEED (ISO) MANUALLY

This camera automatically reads the film speed from the film's DX code. However, the film speed setting can be changed. If you use a non-DX coded film, set the film speed manually.

How to set

- 1 Load the non-DX coded film.
Set the mode dial to **ISO**.

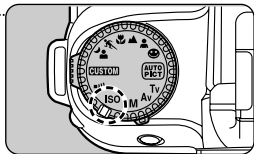

- 2 Turn the select dial to set the ISO film speed.

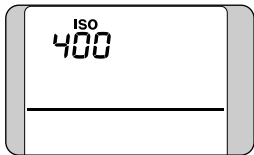
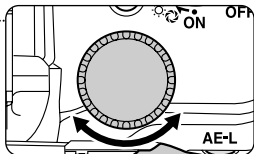

- 3 After setting the ISO speed, set the mode dial to the desired mode position other than **ISO**, **CUSTOM** and **■||)**.

MEMO





- The shutter cannot be released when the mode dial is set to **ISO**, **CUSTOM** or **■||)**.
- **ISO** is displayed when you set a film speed other than the DX coded film speed.

3

ADVANCED OPERATIONS

SELECTING A DRIVE MODE

This camera has a total of five drive modes as shown.

<p>Single-frame drive mode</p> 	<p>One picture is taken each time the shutter release button is pressed. See page 40.</p>
<p>Consecutive shooting</p> 	<p>Pictures can be taken consecutively while the shutter release button is held down. See page 55.</p>
<p>Self-timer mode</p> 	<p>A picture will be taken with a 12-second-delay. See page 56.</p>
<p>Remote control shooting</p> 	<p>The shutter can be released with the optional remote control. See page 59.</p>
<p>Multiple-exposure shooting</p> 	<p>Pictures can be exposed on the same frame multiple times. See page 61.</p>

Consecutive Shooting

Pictures can be taken consecutively while the shutter release button is held down.

- 1 Press the drive mode button until  appears on the LCD panel.

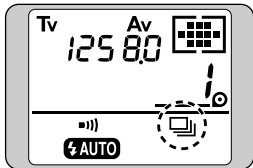
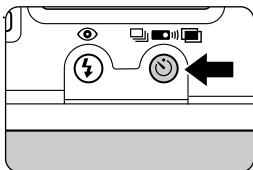

- 2 Shoot consecutive frames.

1. Press the shutter release button halfway down to focus the subject.
2. Press and hold down the shutter release button completely.
3. To stop taking consecutive pictures, take your finger off of the shutter release button.

MEMO

- When the focus mode switch is set to **[A.F.S.]** (single), the focus is locked for the first frame and used for subsequent consecutive frames.
- When the focus mode switch is set to **[A.F.C.]** (continuous), the camera tries to focus on the subject each time the shutter is released; however, the focus may be incomplete for consecutive frames.
- The shutter cannot be released while the built-in flash is being charged. To enable shutter release before the built-in flash is ready, use custom function 17 (MF7). See pages 34 and 108.

SELECTING A DRIVE MODE

Self-Timer Mode

After pressing the shutter release button, the picture will be taken about 12 sec. later. Use the self-timer when you wish to include yourself in the picture.

1 Mount the camera on the tripod.

- If you use a large tripod, see “MEMO” on page 58.

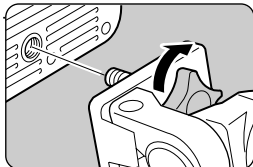

2 Press the drive mode button until appears on the LCD panel.

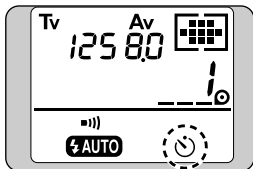
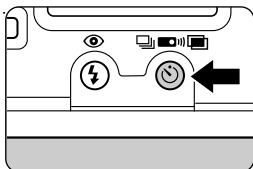

3 Press the shutter release button halfway down to compose and focus on the subject.

When the subject is in focus,  lights up in the viewfinder.

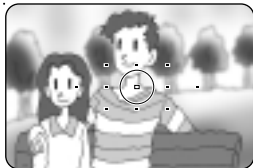

4 Press the shutter release button completely.

The shutter will be released about 12 seconds after the shutter release button is pressed.

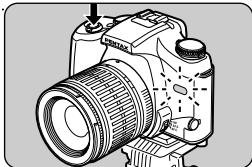

The self-timer lamp starts blinking slowly and blinks rapidly two seconds before the shutter is released. Also the audible PCV signal is heard and the rate increases for the last two seconds.

MEMO

- The audible PCV signal can be turned off. See page 87.
- To stop the self-timer operation after it has been activated, press the drive mode button again.

MEMO Preventing stray light entering the eyepiece

- When using accessories such as the finder cap, remove the Eyecup F_M by pulling it sideways (either to the right or left) then pull it towards you.
- Under exposure may occur if light enters the viewfinder during self-timer operation in all auto exposure modes. If you intend to move away from the viewfinder, attach the supplied finder cap or use AE lock function (see page 86).

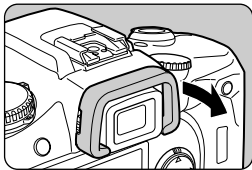

Removing the Eyecup F_M

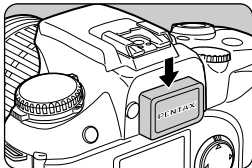

Attaching the viewfinder cap

SELECTING A DRIVE MODE

5 Press the drive mode button after the picture is taken.

The camera is released from self-timer mode (☺) (disappears from the LCD panel) and returns to single-frame drive mode.

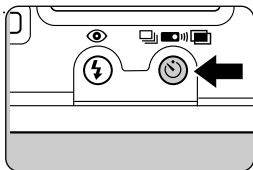

MEMO

- To cancel the self-timer operation before it is completed, press the drive mode button.
- If you use a large tripod, be sure to install the supplied auxiliary tripod plate between the camera and pan/tilt tripod head, otherwise the pan/tilt tripod head may contact the lens.

Mirror lock-up function

With mirror lock-up, you can prevent camera shake caused by the reflex mirror's movement. When the shutter release button is pressed, the reflex mirror stays up and the shutter is released about 2 seconds later.

To take a picture with mirror lock-up, follow the procedure below:

1. Set custom function number [CF12] to [2]. See pages 134 and 140.
2. Press the drive mode button until ☺ appears on the LCD panel.
3. Focus on the subject, then fully press the shutter release button.

After the reflex mirror locks up, the picture will be taken 2 seconds later. AE lock is enabled with the exposure value immediately before mirror lock-up.

Remote Control Shooting

The shutter will be released 3 seconds after the optional remote control's shutter release button is pressed.

1 Mount the camera to a tripod.

- If you use a large tripod, be sure to install the supplied auxiliary tripod plate between the camera and pan/tilt tripod head, otherwise the pan/tilt tripod head may contact the lens.

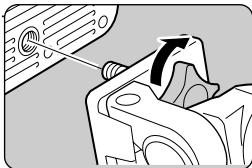

2 Press the drive mode button until appears on the LCD panel.

Confirm that the subject is in focus by pressing the shutter release button halfway down.

- Remote control operation does not activate focusing with the default setting. Use custom function number [CF14] to focus automatically with remote control operation. See pages 134 and 141.

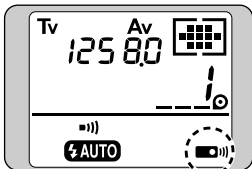
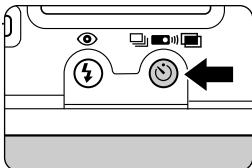

3 Press the shutter release button on the remote control toward the camera.

The self-timer lamp blinks and the audible PCV signal sounds during remote control shooting.

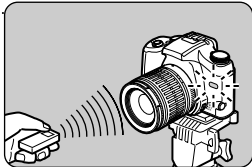

SELECTING A DRIVE MODE

- 4** When the picture is taken, the self-timer lamp lights for approx. 2 seconds and will begin to blink slowly.

Press the drive mode button after the picture is taken. The camera is released from remote control shooting mode and returns to single-frame drive mode.

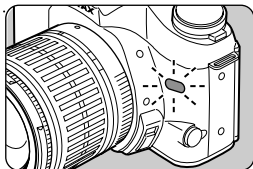

MEMO

- The operating distance of the wireless remote control is approx. 5m from in front of the camera.
- Under exposure may occur if light enters the viewfinder during remote control shooting in any picture or exposure mode except manual exposure mode. Use the supplied viewfinder cap (see page 57) or AE lock function (see page 86).
- To stop the remote control operation after it has been activated, press the drive button or turn the main/preview switch off.
- If you want the camera to operate immediately (without a 3-second delay) after pressing the shutter release button on the remote control, use custom function number [CF13]. See pages 134 and 140.
- The remote control may not operate in backlit conditions.
- The remote control does not work while the flash is being charged.
- When the remote control shooting mode is left unused for 5 minutes, the single-frame drive mode will be automatically set.
- The built-in flash will not be popped up automatically in the remote control shooting mode.
- See page 150 for the remote control specification.

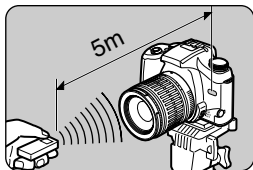

Multiple Exposures on a Single Frame

Pictures can be exposed on the same frame multiple times. For example, it is possible to take a picture of a dark background then a picture of a bright (or flash-lit) subject on the same frame.

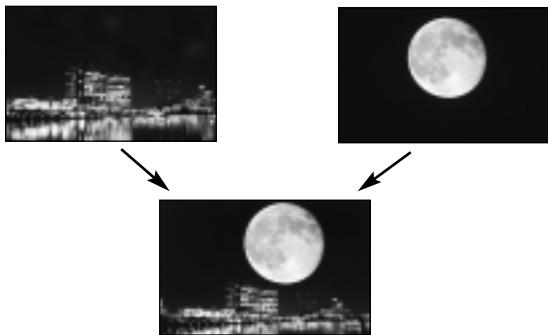

- 1 Press the drive mode button until  appears on the LCD panel.

The frame number on the LCD panel blinks.

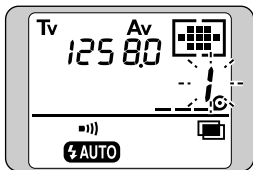
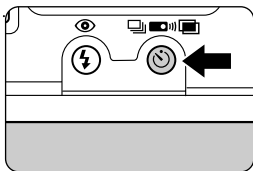

SELECTING A DRIVE MODE

2

① **Take the first picture.**

The frame number and  on the LCD panel blink.

② **Take the second picture.**

The frame number stops blinking and the film is advanced to the next frame, then the camera returns into single-frame drive mode.

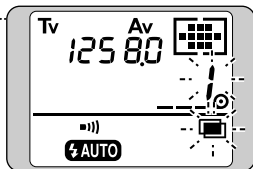

MEMO

- To expose the third shot, press the drive mode button after step 2-①, then go to step 2-②. To expose more shots, always press the drive mode button to let  stop blinking in advance of taking the next shot. If you do not press the drive mode button before taking the next shot, that shot will be the last one.
- The multi-exposure shooting mode remains in effect even after the main/preview switch is turned off. To cancel the multi-exposure shooting mode, remove the batteries once and load again. After replacing the batteries, be sure to set the time and date imprinting mode again. See page 28.

AUTO BRACKETING

When you pressed shutter release button, three consecutive frames will be taken at different exposures. The first frame is exposed with no compensation. The second frame is under exposed and the third frame is over exposed. The bracketing amount can be set to ± 0.3 , ± 0.5 and ± 1.0 EV.



Exposure with no compensation



Under exposure



Over exposure

MEMO

- If the exposure compensation amount is small, the effect will not be noticeable on negative film (especially on negative color print processed by auto-print).

1 Press the auto bracketing button until  and the bar graph appear on the LCD panel.

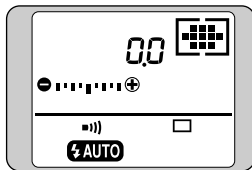
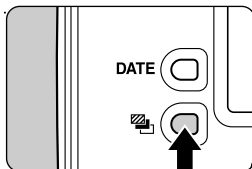

AUTO BRACKETING

- 2 Turn the select dial while holding the auto bracketing button to set the exposure bracketing step.**

The exposure bracketing step will be fixed when the auto bracketing button is released.

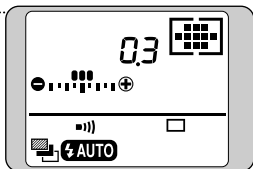

- 3 Press the shutter release button halfway down to focus on the subject.**

The bar graph is displayed in the viewfinder and the current exposure bracketing step blinks.

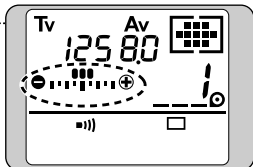

- 4 Hold down the shutter release button.**

The three pictures will be taken. The exposure with no compensation for the first frame. For the second frame, it indicates the minus side for under exposure. For the third frame, it indicates the plus side for over exposure.

The mode returns to single-frame drive mode automatically after the third picture is taken.

MEMO

- When the focus mode switch is set to **AF.S** (single), the focus is locked for the first frame and used for subsequent consecutive frames.
- When the focus mode switch is set to **AF.C** (continuous), the camera tries to focus on the subject each time the shutter is released; however, the focus may be incorrect for consecutive frames.







- If you take a finger off from the shutter release button during auto bracketing, the auto bracketing exposure setting will remain effective for about 20 seconds and you can take the next picture by pressing the shutter release button again. In this case, auto focusing works for each frame.
- You can combine this function with the built-in flash or external flash (TTL and P-TTL auto only) to change the amount of flash consecutively. Make sure the external flash is fully charged before pressing the shutter release button each time.
- You can change the auto bracketing sequence using the custom function number [CF1]. See pages 134 and 136.
- Auto bracketing is automatically canceled after the third frame is exposed. You can change this setting using the custom function [CF2]. See pages 134 and 137.
- You can combine this function with the consecutive shooting mode. In this case, you can take consecutive auto bracketing shots by pressing the shutter release button continuously.
- You can combine this function with the self-timer mode or the remote control shooting mode. In this case, the camera returns to single-frame drive mode after shooting the third frame.

Taking pictures under exposer or over exposer only

You can use the auto bracketing mode for only under exposure or over exposure shots by combining the operation with exposure compensation. In this case, the specified exposure compensation value is used for auto bracketing. See page 85.

SELECTING THE PICTURE MODES

The camera incorporates the Auto picture mode function. In this mode, the camera automatically selects one of the five picture modes depending on the camera-to-subject distance and image magnification. You can also select your desired picture mode manually. The picture mode has a total of 6 modes as follows. See page 68 to 73 for details of each mode.

	Auto picture mode (The proper exposure is automatically selected.)..... 41
	Standard Program Mode 68
	Portrait Program Mode 69
	Landscape Program Mode 70
	Close-up Program Mode 71
	Action Program Mode 72
	Night-Scene Program Mode..... 73

- 1** Set the mode dial to the desired picture mode.

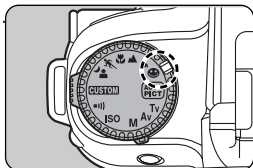

- 2** The selected mode is displayed in the viewfinder.



MEMO

- When using an F or FA lens, set the lens aperture ring to the **A** position while holding down the aperture-A lock button on the lens.

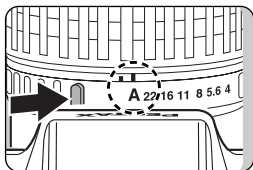

The built-in flash pops up and discharges automatically in low light and backlight conditions, when **⚡ AUTO** is displayed on the LCD panel.

SELECTING THE PICTURE MODES

1. Standard Program Mode

To take a basic picture, use the Standard program mode. You simply press the shutter release button. The camera selects the best combination of aperture and shutter speed setting.



1 Set the mode dial to .

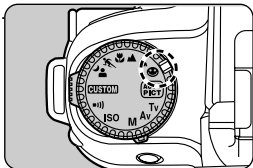

- When the shutter release button is pressed halfway, the shutter speed and aperture setting are displayed in the viewfinder and on the LCD panel.  is also displayed in the viewfinder.

2. Portrait Program Mode

This mode is suitable for taking portrait photography.



1 Set the mode dial to .

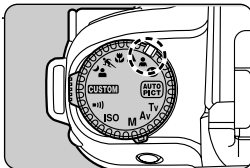

- When the shutter release button is pressed halfway, the shutter speed and aperture setting are displayed in the viewfinder and on the LCD panel.  is also displayed in the viewfinder.

MEMO

- In this mode, the telephoto lens produces a portrait in crisp focus against the out-of-focus background, while the wide-angle lens enables you to shoot group photography or snapshots in sharp and clear focus with the extended depth-of-field.

3. Landscape Program Mode

This mode is ideal for landscape photography and scenic snapshots.



1 Set the mode dial to  .

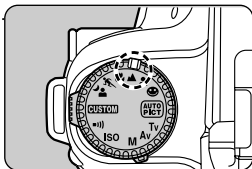

- When the shutter release button is pressed halfway, the shutter speed and aperture setting are displayed in the viewfinder and on the LCD panel.  is also displayed in the viewfinder.

MEMO

- When a photo of a landscape is taken in this mode, the resulting photograph will be in focus for the entire landscape, including objects close-up and those in the distance.

4. Close-up Program Mode

This mode is convenient when taking close-up photos of flowers and so forth.



1 Set the mode dial to .

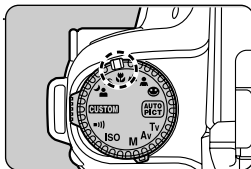

- When the shutter release button is pressed halfway, the shutter speed and aperture setting are displayed in the viewfinder and on the LCD panel.  is also displayed in the viewfinder.

MEMO

- This mode favors smaller apertures to maximize the depth of field, ensuring sharp focus of a close-up subject.

SELECTING THE PICTURE MODES

5. Action Program Mode

This mode selects a faster shutter speed to capture a moving subject.

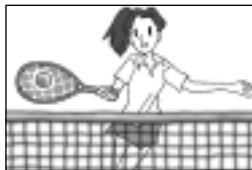

1 Set the mode dial to  .

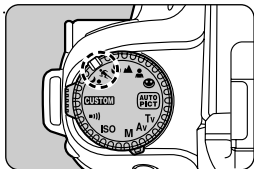

- When the shutter release button is pressed halfway, the shutter speed and aperture setting are displayed in the viewfinder and on the LCD panel.  is also displayed in the viewfinder.

MEMO

- This mode freezes the action and prevents blurred images. This mode is especially convenient for active photography. It is also suitable for portraits with blurred background.
- In this mode, the camera focuses on the subject continuously when the shutter release button is pressed halfway down, and the shutter can be released whenever the subject is in focus or out of focus.

6. Night-Scene Program Mode

This mode is useful when taking a portrait photograph with a night scene in the background.



1 Set the mode dial to .

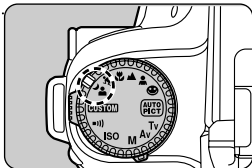

- When the shutter release button is pressed halfway, the shutter speed and aperture setting are displayed in the viewfinder and on the LCD panel.



 is also displayed in the viewfinder.

MEMO

- It is possible to photograph subjects and background in a balanced way by using the flash to properly expose the foreground subject and a slow-speed to expose the low light background. The shutter speed automatically changes in the range of 1/125 to 1 second.
- Use of a tripod is recommended to prevent camera shake because of the slow shutter speed in this mode. If the subject is not still, the picture will be blurred.
- Check that the flash is fully charged before shooting.
- The Standard program mode is automatically set when the built-in flash is not in use.
- If you use a large tripod, be sure to install the supplied auxiliary tripod plate between the camera and pan/tilt tripod head, otherwise the pan/tilt tripod head may contact the lens.

SELECTING ANOTHER EXPOSURE MODE

Effect of Aperture and Shutter Speed

A correct exposure is established by a combination of shutter speed and aperture setting according to the subject's brightness. There are many correct combinations of shutter speed and aperture for a particular subject's brightness. Different shutter speed and aperture settings produce different effects.

Effect of shutter speed

The shutter speed determines the film exposure times, or the length of time that the light is allowed to strike the film.

If the subject is moving, the image will be blurred when a slow shutter speed is used. It is possible to enhance the effect of motion, (The movement of a waterfall) by intentionally using a slower shutter speed.

Choosing a faster shutter speed will allow the image of a moving subject to be frozen. A faster shutter speed also helps prevent camera shake.



Slower shutter speed



Faster shutter speed

Effect of aperture

The aperture increases or reduces the amount of reflected light from an object which passes through the lens, controlling how much light strikes the film.

If the aperture is opened up to increase the amount of light, subjects in front of and behind an in-focus subject will not be focused. That is, the range of focus (depth of field) becomes small. If the aperture is stopped down to reduce the amount of light, the depth of field increases. For instance, if you shoot a person against a landscape with the aperture open, the landscape in front of and behind the person will be blurred, making the person appear to rise out of the landscape. By contrast, stopping down the aperture increases the in-focus range.



Open aperture



Stopped down aperture

MEMO

- The depth of field increases when you use a wider angle lens or the subject is farther from the camera. Zoom lenses do not have a scale for depth of field because of its structure.

SELECTING ANOTHER EXPOSURE MODE

Using the Shutter-Priority AE Mode

When the desired shutter speed is selected, the appropriate aperture is automatically set by the camera for a proper exposure according to the brightness of the subject. This mode is suitable for freezing the action with a faster shutter speed or capturing a flowing dynamic image with a slower shutter speed. See page 74 for the effect of shutter speed.

- 1** Set the mode dial to **Tv**.

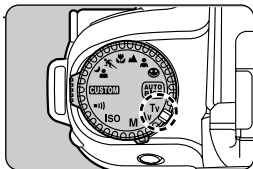

- 2** Select the desired shutter speed by turning the select dial.

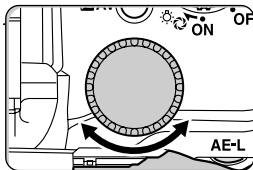

- 3** Confirm the shutter speed and aperture value in the viewfinder or on the LCD panel.

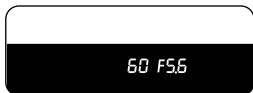
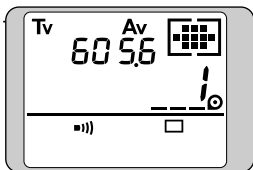

MEMO

- When using an F or FA lens, set the lens aperture ring to the **A** position while holding down the aperture-A lock button on the lens.

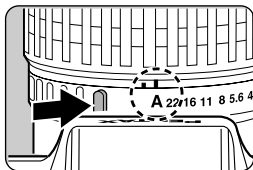

* Exposure Warning

If the subject is too bright or too dark, the selected aperture value will blink in the viewfinder and on the LCD panel as a warning (as shown). When the subject is too bright, choose a faster shutter speed.

If it is too dark, choose a slower shutter speed. When the shutter speed indication stops blinking, you can take the picture. If both selected shutter speed and aperture blink, it means that the exposure is out of metering range, unable to obtain a correct exposure even if the shutter speed is adjusted. Use an ND (Neutral Density) filter or select a darker subject if the subject is too bright. Use a flash if it is too dark.

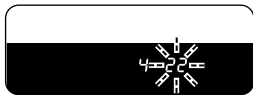
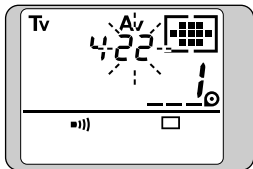

MEMO

- When using an F or FA lens, set the lens aperture ring to the **A** position while holding down the aperture-A lock button on the lens.

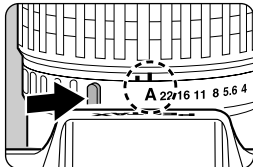

Exposure Warning

If the subject is too bright or too dark, the selected shutter speed will blink in the viewfinder and on the LCD panel as a warning (as shown).

When the subject is too bright, choose a smaller aperture (larger number), if available; when it is too dark, choose a larger aperture (smaller number), if available. When the shutter speed indication stops blinking, you can take the picture. If both shutter speed and aperture blink, it means that the exposure is out of metering range, unable to obtain a correct exposure even if the aperture is adjusted. Use an ND (Neutral Density) filter or select a darker subject if the subject is too bright. Use a flash if it is too dark.

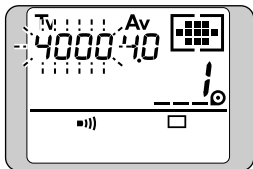

- 4** Turn the select dial to change the aperture value while holding down the AV button .

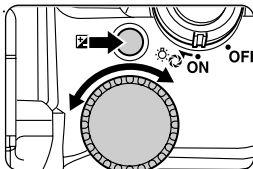

- 5** Confirm the shutter speed and aperture value in the viewfinder or on the LCD panel.

If the  dot is in the center of the bar, it indicates correct exposure.

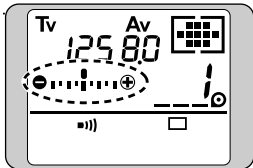

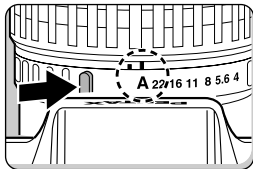

MEMO

- When using an F or FA lens, set the lens aperture ring to the  position while holding down the aperture-A lock button on the lens.



About the bar graph

If the  dots are on the minus side of the bar graph, it indicates under exposure. If they are in the plus side, it indicates over exposure.

If the exposure setting exceeds ± 2 EV,  or  blinks.

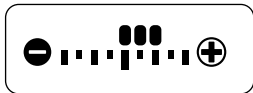

+1 EV over exposure

SELECTING ANOTHER EXPOSURE MODE

MEMO

- The AE lock does not operate in the Metered Manual Mode.
- When using negative color film, the finished print is not greatly affected by a certain amount of over- or under-exposure. This is because color negative film has wide latitude. If you use positive (slide) film, which has narrow latitude, you need to adjust the aperture and shutter speed to intentionally over- or under-expose the shot.

Exposure Warning

If the subject is too bright or too dark, both shutter speed and aperture setting will blink in the viewfinder and on the LCD panel. It means that the exposure is out of metering range, unable to obtain a correct exposure even if the shutter speed and aperture are adjusted. Use an ND (Neutral Density) filter or select a darker subject if the subject is too bright. Use a flash if it is too dark.

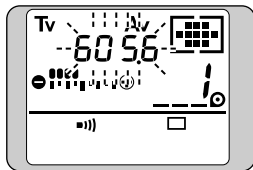

Slow-Speed-Sync Mode

It is possible to balance the exposure of a foreground subject against a low light background by using the flash to properly expose the foreground subject and a slow-shutter-speed to expose the low light background.

With the Night-scene program mode

1. Set the the mode dial to .

When using an F or FA lens, set the lens aperture ring to the  position while holding down the aperture-A lock button on the lens.

2. The built-in flash pops up automatically.

3. Before shooting, confirm that the flash is fully charged.

With the Metered Manual Mode

1. Press the flash pop-up button to activate the built-in flash.

2. Set the exposure mode to the Metered Manual Mode.

3. Select an appropriate shutter speed (slower than 1/125 of second) and aperture combination for a correct exposure on the LCD panel.

4. Before shooting, confirm that the flash is fully charged.

MEMO

- The slow-speed-sync can also be used with the shutter-priority AE mode set. Confirm that the exposure warning is not appearing in the viewfinder.
- In the slow-speed-sync shooting, use of a tripod is recommended to prevent camera shake.

USING THE BULB EXPOSURE MODE

This mode is useful for the long exposures required for shooting night scenes and fireworks. The shutter remains open as long as the shutter release button is held down.

- 1 **With the Metered Manual Mode, turn the select dial to change the shutter speed until `bu` appears on the LCD panel.**

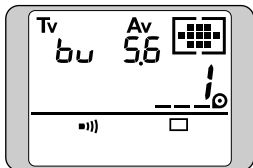
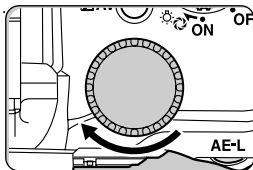

MEMO

- When using this mode, use a steady tripod to prevent camera shake and attach the optional “Cable Switch CS-205” after opening the release socket cap.
- Up to approx. 5 hours of time exposure are possible with new lithium batteries at ambient temperatures.
- With the remote control shooting mode, the shutter remains open as long as the optional remote control's shutter release button held down.

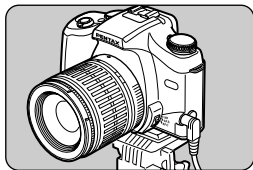

ABOUT EXPOSURE COMPENSATION

The exposure compensation allows you to deliberately over exposure (brighten) or under exposure (darken) a subject, or compensate for difficult lighting conditions which may fool the camera's built-in exposure meter. The exposure compensation range is -3 EV to +3 EV in 0.5 EV steps.

1 While holding down the AV button, turn the select dial to set the desired compensation value on the LCD panel.

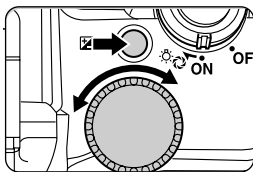

2 Confirm the compensation value in the viewfinder or on the LCD panel.

 appears in the viewfinder and on the LCD panel.

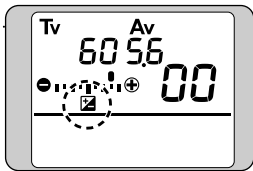

About the bar graph

If the  dots are on the minus side of the bar graph, it indicates under exposure. If they are in the plus side, it indicates over exposure.

Moving one dot on the bar graph indicates 0.5 step (0.5 EV).

MEMO

- Exposure compensation does not work in the metered manual mode and bulb exposure mode.
- The exposure compensation cannot be canceled even if the power is turned OFF or any other exposure mode is set.
- The bar graph can indicate -2 EV to +2 EV. If you set a value outside this range,  blinks on either end of the bar.



-2 stop EV: bottom of bar graph

+2 stop EV: Top of bar graph

*In increments of 0.5 stop EV

AE LOCK FUNCTION

You can lock the exposure setting before you take the picture. If the subject is too small or backlit and a proper exposure setting cannot be obtained, you can zoom in on the subject to obtain the proper exposure setting. Then lock the exposure setting and recompose to take a picture.

1 Press the AE lock button

AE-L.

The measured exposure level is locked for 20 seconds.

To cancel the AE lock, press the AE lock button again.

***** is displayed in the viewfinder.

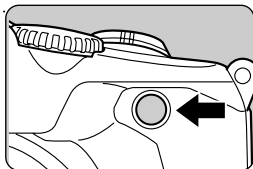

MEMO



- The measured exposure level remains locked as long as the AE lock button is kept pressed or the shutter release button is kept pressed halfway (even after 20 seconds).
- With the custom function number [CF4], you can select the function of the AE lock button between auto focusing and auto exposure metering. See page 137.
- When the AE lock button is pressed, audible PCV signal is heard. This audible PCV signal can be turned off. See page 87.
- The auto pop-up built-in flash function does not work while the AE lock is in use. (**AUTO** goes off of the LCD panel).
- AE lock does not work in the metered manual mode and bulb exposure mode.
- If a zoom lens whose maximum aperture varies depending on the focal length, the combination of shutter speed and aperture value changes depending on the zooming position even while the AE lock is working. However, the exposure value does not vary, therefore, a picture is taken at the brightness level set by the AE lock.

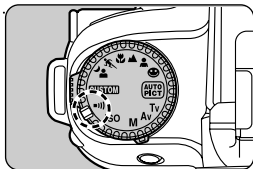

TURNING OFF THE AUDIBLE PCV SIGNAL

You can change the audible PCV signal on or off when the self-timer, remote control, AE lock function is in use or when the subject is in-focus.

1 Set the mode dial to  .



2 Turn the select dial to display  or  on the LCD panel.

 appears on the LCD panel when  is selected.

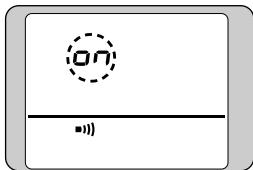
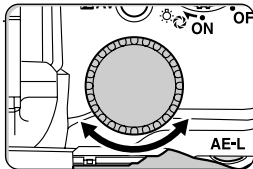

3 Set the mode dial to the position other than  , **CUSTOM** and **ISO**.

MEMO

- The shutter cannot be released when the mode dial is set to  , **CUSTOM** or **ISO**.

SWITCHING THE METERING MODE

Multi (16)-segment metering, center-weighted metering, or spot metering mode can be selected in this camera.

Select the desired metering mode with the metering mode switch.

Using Multi(16)-Segment Metering

This mode automatically measures light in 16 different zones, enabling proper exposure value in a wide variety of normal and backlight conditions. (Even backlit subjects do not become dark.)

MEMO

- When multi-segment metering, the scene in the viewfinder is metered by 16 different zones as shown in the illustration.

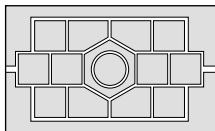

1 Set the metering mode switch to .

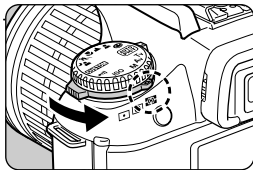

MEMO

- When a lens other than an FA J, FA, F or A lens is attached, the center-weighted metering mode is automatically set even if you select the multi-segment metering mode. (This type of lens can only be used when custom function number [CF17] is set to [2]. See pages 134 and 142.)

Using Center-Weighted Metering

This mode does not automatically compensate for back lighted or spotlighted scenes like the multi (16)-segment metering mode. Creative exposure control is decided by the user.

MEMO

- The metering pattern in the illustration shows that the upper part of the pattern (in the center of the viewfinder) has more sensitivity to light than the lowest part. This metering mode does not compensate for backlit subjects.

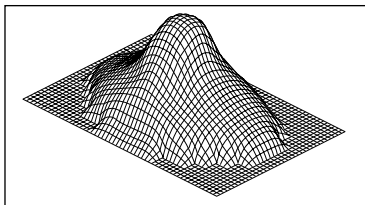

- 1** Set the metering mode switch to  .

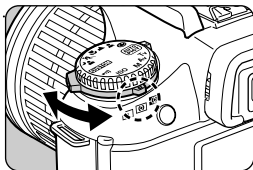

Using Spot Metering

This mode measures light only in the small area in the center of the viewfinder. You can use AE lock (see page 86) to lock the spot metering exposure and recompose to take the picture.

MEMO

- With spot metering, the exposure is weighted on the small area at the center, as shown in the illustration.

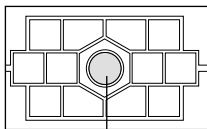

Spot metering zone

- 1** Set the metering mode switch to  .

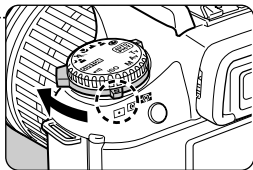

ABOUT FOCUSING

The autofocus mode (AF.S/AF.C), manual focus mode, and focus point modes are explained here.

There are three main focusing methods.

1. Autofocus

The camera focuses automatically. There are two AF modes.

While you press the shutter release button halfway:

- AF Single (AF.S) mode locks the focus, and
- AF Continuous (AF.C) mode adjusts the focus continuously.

See pages 92 and 93 for details.

2. Manual focusing

You can adjust the focus manually.

3. Selecting the focus point

You can select the desired focus point in the viewfinder or fix the focus point in the center position. See pages 96 and 97.

Using the AF Single Mode (AF.S)

- 1** Set the focus mode switch to **AF.S**.

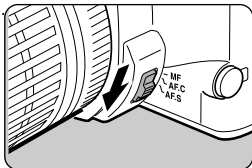

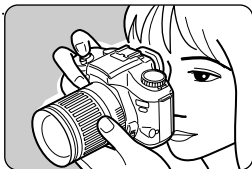

- 2** Frame the subject, then press the shutter release button halfway down.



- 3** When the subject is in focus, the focus indicator  lights up in the viewfinder, and the audible PCV signal beeps.



MEMO

- While the focus indicator  is lit, the focus will be locked (focus lock). If you want to focus on another subject, take your finger off from the shutter release button once to release the focus lock.
- If the focus indicator  blinks, it indicates that focus has not been achieved. In the AF Single mode (AF.S), you cannot take a picture while the subject is out of focus. If the subject is too close to the camera, move back and take the picture. If the camera still has difficulty focusing (see page 101), the subject focus manually (see page 94).

Using the AF Continuous Mode (AFC)

- 1** Set the focus mode switch to **AFC**.

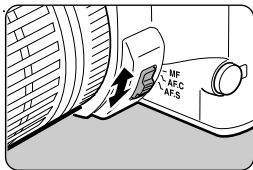

- 2** Frame the subject, then press the shutter release button halfway down.

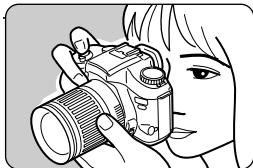

- 3** When the subject is in focus, the focus indicator  lights up in the viewfinder, and the audible PCV signal beeps.



MEMO

- In the AF Continuous (AFC) mode, the camera switches to the predictive AF mode automatically when a moving subject is detected. It then focuses the subject continuously.
- In the AF Continuous (AFC) mode, the shutter can be released even when the subject is out of focus.

Manual Focusing

When you focus manually, you can either check with the focus indicator  or the viewfinder's matte field to adjust focus.

Using the focus indicator

- 1** Set the focus mode switch to **MF**.

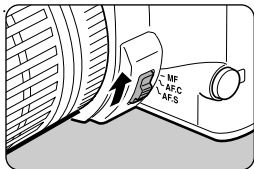

- 2** Frame the subject, then turn the focusing ring to the right or the left until the subject is in focus.

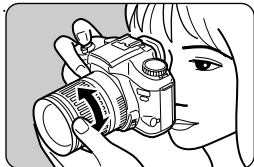

- 3** When the subject comes into focus, the focus indicator  lights up and the audible PCV signal beeps.



MEMO

- The audible PCV signal can be turned off. See page 87.
- If the subject is difficult to focus (see page 101) and the focus indicator  keeps blinking, use the viewfinder's matte field as described below.

Using the viewfinder's matte field

- 1** Set the focus mode switch to **MF**.

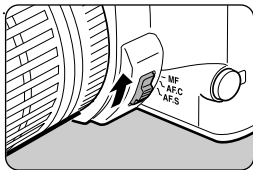

- 2** Frame the subject, then turn the focusing ring to the right or the left until the subject looks sharp in the viewfinder.

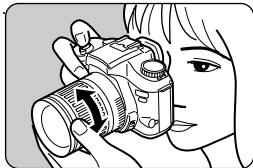

Selecting the Focus Point

There are 11 focus points in the viewfinder. If the focus point mode switch is set to automatic (see page 44) and the camera does not select the desired focus point, you can select the desired focus point manually.

- 1** Set the focus point mode switch to **SEL**.

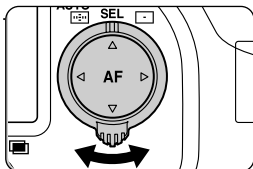

- 2** Look through the viewfinder and check where you want to focus.

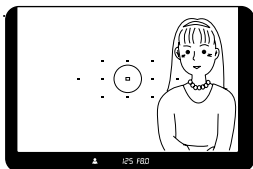

- 3** Use the four-way controller **▲ ▼ ◀ ▶** to select the desired focus point.

The selected focus point is superimposed in red in the viewfinder. If you have trouble seeing the superimposed focus point because of the backlit or other conditions, check it on the LCD panel.

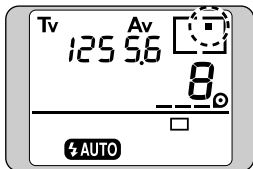
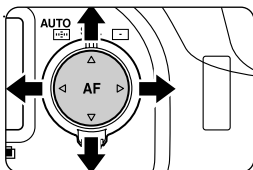

MEMO

- To cancel the selected focus point, set the focus point mode switch to **AUTO**.

Setting the Focus Point to the Center of the Viewfinder

- 1 Set the focus point mode switch to .

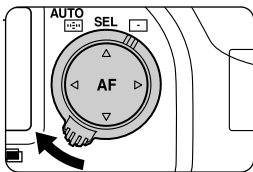

- 2 The subject in the center of the viewfinder which is superimposed in red is in focus when the shutter release button is pressed halfway down.



MEMO

- To cancel the selected focus point, set the focus point mode switch to



Using the Focus Lock

If the subject is not covered by any of the focus points, the camera cannot automatically focus the subject. In this situation, you can aim the focus point on the subject, use focus lock, then recompose the picture.

- 1 Set the focus mode switch to **AF.S**.**

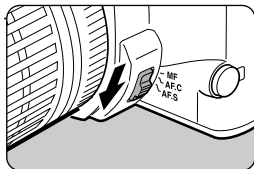

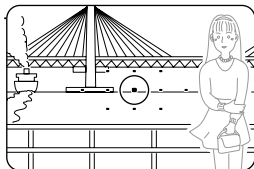

- 2 Frame the subject. If the subject you wish to focus on is not on any of the focus points, you can use focus lock.**



The figure to the right shows the person is not focused and the background is focused instead.

3 Aim the center of the viewfinder over the subject, then press the shutter release button halfway down.

When the subject comes into focus, the focus indicator  lights up and the audible PCV signal beeps. (If  is blinking, the subject is not in focus.) The focus is locked while  is lit (focus lock).

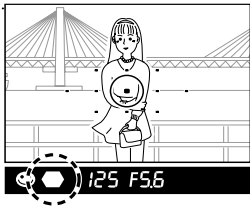

4 Re-compose the picture while pressing the shutter release button halfway down.

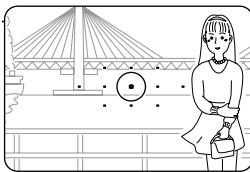

MEMO

- Turning the zooming ring in focus lock mode may cause the subject out of focus.
- The audible PCV signal can be turned off. See page 87.

Previewing the Depth of Field

Before taking a picture, you can check the depth of field in the viewfinder.

1 Adjust focus to the subject.

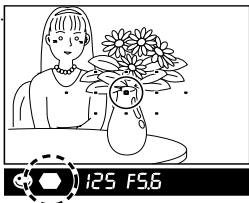

2 While looking through the viewfinder, turn the main/preview switch to .

You can check the focused area in the viewfinder while the main/preview switch is in  position.

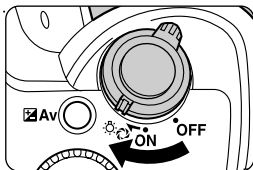





MEMO

- While the main/preview switch is in  position, no shooting information is displayed and the shutter cannot be released.
- The focus range display in the viewfinder may differ slightly from the actual picture.

Hard-to-Autofocus Subjects

The autofocus system is highly precise, but not perfect. Depending on the brightness, contrast, shape, and size of your subject, the autofocus system may not operate. In such a case, set the focus mode switch to **MF** and use the manual focus mode to focus the lens on the subject with the aid of the matte field in the viewfinder (see pages 94 and 95).

Subjects, which may fool the autofocus system, include:

- a) Extremely low-contrast subjects such as a white wall in the focus points .
- b) Subjects which don't reflect much light in the focus points .
- c) Subjects that are moving too fast.
- d) Multiple subjects in the foreground and background of the focus points . In this case, the subject may not be in focus even if the focus indicator  is lit.
- e) Subjects positioned against reflected light or strong backlight or with extremely bright backgrounds.
- f) If vertical or horizontal line patterns appear in the focus points .

Notes on Accessories

If you use any special effect filter, Magic Image Attachment or Stereo Adapter, autofocus and manual focus using the focus indicator  in the viewfinder cannot be used. In this case, use manual focus using the viewfinder's matte field. See page 95.

USING THE BUILT-IN FLASH

Auto Pop-up Flash Function

In this mode, the built-in flash pops up and discharges automatically in low light and backlight condition.

- 1 Press the flash mode button until  appears on the LCD panel.

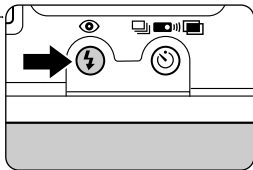

- 2 Press the shutter release button halfway down, and the built-in flash automatically pops up when the flash is required.

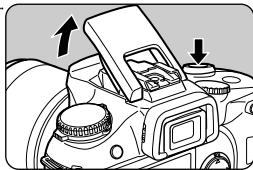

- 3 When the flash is ready to discharge, the  appears in the viewfinder and on the LCD panel.

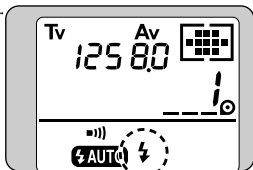

 **MEMO**

- The built-in flash automatically retracts only when the power is turned off. Push down the built-in flash into the camera body when not in use.
- The built-in flash does not discharge when not required even though it is been in the up position.
- When the built-in flash is used, using the lens hood is NOT recommended as it may obstruct the path of the light coming from the flash, causing vignetting in the picture corners.
- Note that the built-in flash automatically pops up in necessary conditions even if an inappropriate lens for flash shooting is used. See page 114 to check the compatibility between the built-in flash and various lenses.
- When using an inappropriate F or FA lens,  will blink rapidly in the viewfinder and on the LCD panel. See page 110 for details.
- If the built-in flash is used continuously, the battery may become warm, but it does not mean that the battery is faulty; it's one of the battery's characteristics.
- The shutter cannot be released until the flash is fully charged.
- To enable shutter release before the flash is charged, set custom function number [CF7] to [2]. See pages 134 and 138.

Selecting the Various Built-in Flash Modes

1 At each press of the flash mode button, the flash mode on the LCD panel changes as shown in the chart.

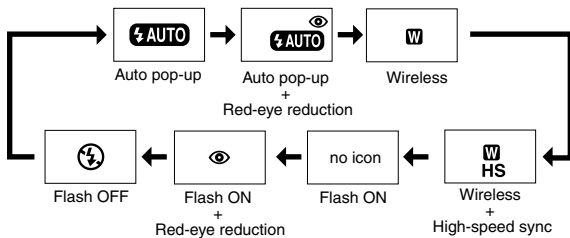
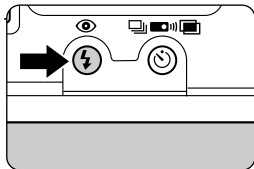

MEMO

- The auto pop-up flash mode can only be set in the auto picture mode and the picture mode. See page 66.
- The built-in flash pops up automatically when **⚡ AUTO** is displayed on the LCD panel. However, it discharges only when required. (Automatic flash function)
- The auto pop-up function of the built-in flash does not work when the AE lock function is in use.
- The automatic flash function can also be used with the external flash.
- Even if **⚡ AUTO** is displayed on the LCD panel, the built-in flash does not pop up automatically when the external flash has been mounted.
- When the built-in flash is popped up and auto pop-up is canceled, the flash discharges even when not required.
- The built-in flash will not discharge when Flash OFF is set.

About Red-eye Phenomenon

Shooting portraits with flash in a dark environment often causes a subject's eyes to turn out reddish in the print. This phenomenon, commonly known as "Red-Eye", is caused by the reflection of the electronic flash in the retina of your subject's eye. It can be reduced by taking a picture in a brighter light condition or by shooting with a wider-angle lens at a closer distance, or by employing the red-eye reduction flash feature. When using a Pentax dedicated flash unit off the camera, it may also help to position the flash as far away from the camera as possible.

Red-eye Reduction Flash Function

This camera includes a red-eye reduction flash function, which reduces the red-eye phenomenon utilizing preflash. In this mode, the preflash is discharged just before the shutter is released which reduces the diameter of the pupil of the eye. Then the main flash is discharged while the pupils are smaller, which in turn reduces the red-eye effect.

MEMO

- If the red-eye reduction is used while the AF360FGZ or AF500FTZ, etc. is set as a slave unit or wireless, the preflash for red-eye reduction will trigger the slave unit to fire. When using a slave unit, do not use red-eye reduction.
- The red-eye reduction feature works even when an only external flash is used. See page 126.

Flash Effective Range for the Auto Picture Mode and Picture Mode

As a rule of thumb the distance for using the built-in flash (which varies with the lens used) is within about four meters (using ISO 400 film).

MEMO

- The flash effective range does not come closer than 0.7m (2.6ft), even if the lens aperture is very small. When a subject is shot at a distance less than 0.7m (2.6ft), the correct exposure cannot be obtained, and you will see vignetting in the picture corners.
- Note the built-in flash pops up even when the subject is far away or beyond the maximum flash effective range. See page 112 for the flash effective range.

POP-UP THE BUILT-IN FLASH MANUALLY

- 1 Press the flash pop-up button to activate the flash.**

The built-in flash starts charging automatically.

When it is fully charged,  appears in the viewfinder and on the LCD panel.

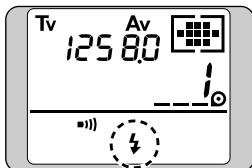
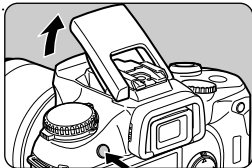

- 2 Press the flash mode button to select a flash mode.**

See page 104 for “Selecting the Various Built-in Flash Modes”.

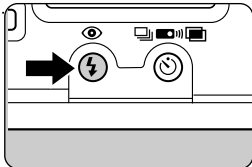



- 3 Press the shutter release button fully, and the flash discharges.**

- 4 After using the Built-in flash, push down the flash head to lock it in the closed position.**

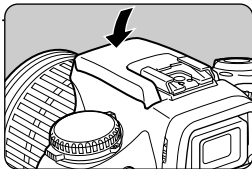
The built-in flash automatically



 **MEMO**

- The built-in flash does not pop up even if the flash pop-up button is pressed with the flash mode is set to  (Flash OFF).
- When the flash pop-up button is pressed,  disappears and  appears on the LCD panel, which indicates the flash always fires regardless of the light conditions.
- The shutter cannot be released until the flash is fully charged.
- To enable shutter release before the flash is charged, set custom function number [CF7] to [2]. See pages 134 and 138.
- Do not use a lens hood with the built-in flash as it may obstruct the path of the light coming from the flash, causing vignetting in the picture corners.
- With the built-in flash popped up, an external flash cannot be attached to the hot shoe. If you would like to use an external flash together with the built-in flash, see the flash connections on page 124.

Daylight-Sync Shooting

In daylight conditions, when a portrait picture is taken with a person's face cast in shadow, discharging the flash will eliminate the shadow.

1. Press the flash pop-up button ().
2. Confirm that the flash mode is set to **Flash ON**.
3. Confirm either the built-in or the external flash is fully charged.

If the background is too bright, it may be over exposed.

4. Take a picture.

MEMO

- When taking a daylight-sync photograph with  displayed on the LCD panel, the flash may not discharge.
- Set the flash mode to Flash ON to discharge flash in daylight.



Without Daylight-Sync



With Daylight-Sync

Using other types of flash



Use of non-Pentax flash units may damage the camera. For the best results, use a Pentax dedicated flash unit.

FLASH RECOMMENDED INFORMATION

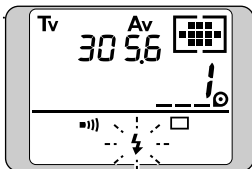
- 1** The flash recommended indicator  in the viewfinder and on the LCD panel blink slowly to warn and recommend you to use the flash when you attempt to take a picture in low light and backlight condition.



MEMO

- In the Shutter-Priority AE Mode and Metered-Manual Mode, the flash recommended indicator  blinks only when attempting to photograph a subject in a backlight situation.
-  stops blinking when the flash is fully charged.
-  will not appear in Bulb mode.

INAPPROPRIATE LENS WARNING WHEN THE BUILT-IN FLASH IS USED

- 1** When using an inappropriate F or FA lens,  will blink rapidly in the viewfinder and on the LCD panel when the shutter release button is pressed halfway down.

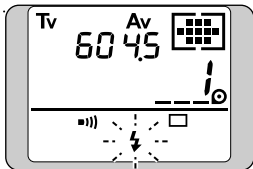



MEMO

- See page 114 for more details on compatibility of F, FA and FA J lenses with the built-in flash.
- Taking a picture while this warning is appeared may cause vignetting in the picture corners or semi-circular vignetting at the bottom of the picture.
- If any lens other than F, FA and FA J is attached, this warning function does not work.
- Note that the auto pop up function works even if this warning appears on the LCD panel.

ADVANCED OPERATION FOR THE BUILT-IN FLASH

1. When Using the Auto Picture and Picture Modes

- The camera automatically chooses an optimum combination of shutter speed and aperture according to the ambient brightness, allowing you to take a flash photograph with ease.
- The shutter speed automatically changes to approximately 1/125 sec. or to a slower speed which does not cause camera shake. The slowest shutter speed depends on the focal length of the lens fitted to the camera. The slowest shutter speed in the Night-scene program mode  is 1 second. When lenses other than an FA J, F and FA are used or the Action program mode  is used, the shutter speed is fixed to 1/125 of second.

2. Shutter-Priority AE Mode

- When taking a fast moving subject, you can increase a subject blur effect. Any desired shutter speed 1/125 sec. or slower can be set for taking a flash photograph.
- In this mode, the aperture automatically changes according to the ambient brightness, making a flash photograph easy.

3. Aperture-Priority AE Mode

- When you want to change the depth of field or shoot any far away subject, you can set the desired aperture to take a flash photograph.
- In this mode, the shutter speed automatically changes with the ambient brightness. The shutter speed changes in range of 1/125 sec. to a slower shutter speed that does not cause camera shake. The slowest shutter speed depends on the focal length of the lens in use. When any lens other than FA J, FA and F is used, the shutter speed is fixed to 1/125 sec.

4. Metered Manual Mode

- When using the built-in flash in the Metered Manual Mode, any combination of aperture and shutter speed 1/125 or slower can be set. In this mode, the exposure of the background can be controlled by the manual exposure to take a flash photograph.

1. Calculating the flash effective range according to the camera-to-subject distance.

Maximum flash distance = Guide Number ÷ Selected aperture
 Minimum flash distance = Maximum flash distance ÷ 5*

*The value 5 used in the formula above is a fixed value applied to the built-in flash in this camera.

MEMO

- When the distance to the subject is less than 0.7m (2.3ft), the flash cannot be used. If the flash is used within 0.7m, it causes vignetting in the picture corners, light is distributed unevenly and the picture may be over exposed.

The guide number (GN) depends upon the film speed used as shown below.

ISO25→GN5.5	ISO200→GN15.6
ISO50→GN7.8	ISO400→GN22
ISO100→GN11	

Example:

If an ISO100 film is used at an aperture of f/3.5, the flash effective distance is obtained as follows:

For maximum distance Guide Number (11) \div f/3.5 = 3.14m

For minimum distance 3.14 \div 5 = 0.63m \rightarrow 0.7m *

* Minimum distance of the built-in flash

Thus, the flash effective distance is from approx. 0.7m to 3.14m.

2. Calculating the aperture according to the camera-to-subject distance

$$\text{Aperture} = \text{Guide Number} \div \text{Camera-to-subject distance}$$

Example:

If the camera-to-subject distance is 2.5m and ISO 100 film is used, the effective aperture is obtained as follows:

Guide Number (11) \div Distance (2.5m) = f/4.4

If the calculated aperture value is different from an indicated f stop, for instance f/4.4, select the next smaller aperture value. (Set at f/4 in this case.)

F, FA and FA J Lenses Compatibility with the Built-in Flash

If an FA J, F or FA lens incompatible with the built-in flash is used, pressing the shutter release button halfway down causes rapid blinking of  in the viewfinder and on the LCD panel as a warning.

If you take a flash picture with an incompatible lens, the corner of the picture may look dark or there may be a dark, semi-circular area on the lower part of the picture.

○ = compatible

△ = Vignetting will occur under the usage conditions

× = incompatible because of vignetting

Lens Name	Compatibility
F, Fish-Eye Zoom 17-28mm f/3.5-4.5	×
FA Zoom 20-35mm f/4 AL	△ Vignetting will occur if focal length is less than 28mm.
FA Zoom 24-90mm f/3.5-4.5 AL (IF)	△ Vignetting will occur if focal length between 24-28mm.
FA* Zoom 28-70mm f/2.8 AL	×
FA Zoom 28-70mm f/4 AL	○
FA Zoom 28-80mm f/3.5-5.6	△ Vignetting may occur in the following cases. <ul style="list-style-type: none"> • The focal length is between 28-35mm and the camera-to-subject distance is 3m or less. • The focal length is 35mm and the camera-to-subject distance is 1m or less.
FA J Zoom 28-80mm f/3.5-5.6 AL	○
FA Zoom 28-90mm f/3.5-5.6	○
FA Zoom 28-105mm f/3.2-4.5 AL (IF)	○
FA Zoom 28-105mm f/4-5.6 (IF)	△ Vignetting may occur if focal length is 40mm or less.
FA Zoom 28-200mm f/3.8-5.6 (IF)	△ Vignetting may occur if focal length is 70mm or less.
F, FA 35-80mm f/4-5.6	○

Lens Name	Compatibility
FA Zoom 70-200mm f/4-5.6	○
FA J Zoom 75-300 f/4.5-5.8 AL	○
FA* Zoom 80-200mm f/2.8 ED (IF)	△ Vignetting may occur if focal length is 80mm to 90mm.
F or FA Zoom 80-200mm f/4.7-5.6	○
FA Zoom 80-320mm f/4.5-5.6	○
F Zoom 100-300mm f/4.5-5.6	○
FA Zoom 100-300mm f/4.5-5.6	○
FA* Zoom 250-600mm f/5.6 ED (IF)	×
FA 20mm f/2.8	×
FA* 24mm f/2 AL (IF)	×
FA 28mm f/2.8 AL	○
FA 31mm f/1.8 AL Limited	○
FA 35mm f/2 AL	○
FA 43mm f/1.9 Limited	○
FA 50mm f/1.4, f/1.7	○
FA 77mm f/1.8 Limited	○
FA* 85mm f/1.4 (IF)	○
FA 135mm f/2.8 (IF)	○
FA* 200mm f/2.8 ED (IF)	○
FA* 300mm f/2.8 ED (IF)	×
FA* 300mm f/4.5 ED (IF)	×
FA* 400mm f/5.6 ED (IF)	○
FA* 600mm f/4 ED (IF)	×
FA MACRO 50mm f/2.8	○
FA MACRO 100mm f/2.8, f/3.5	○
FA* MACRO 200mm f/4.0 ED (IF)	○
FA Soft 28mm f/2.8	○
FA Soft 85mm f/2.8	○

USING EXTERNAL FLASH

Flash Functions

CAMERA FUNCTION \ FLASH	FLASH				
	A	B	C	D	E
Red-eye reduction flash	○	○	×	○ ^{*1}	×
Automatic flash discharge	○	○	○	○	○
After the flash is charged, the camera automatically switches to the flash-sync speed.	○	○	○	○	○
Automatic aperture setting in the Auto Picture/ Picture Mode or Shutter-Priority AE Mode	○	○	○	○ ^{*2}	○ ^{*2}
Flash confirmation in the viewfinder	×	○	○	×	×
P-TTL auto flash	×	○ ^{*3}	×	×	×
TTL auto flash	○	○	○	○ ^{*4}	×
Slow-speed sync	○	○	○	○	○
AF illuminator	×	○	○	×	×
Trailing shutter curtain sync flash ^{*5}	○ ^{*6}	○	○	×	×
Contrast-control-sync flash mode ^{*5}	×	○	×	×	×
Slave flash	×	○	×	×	×
Multiple burst flash	×	○ ^{*7}	×	×	×
High-speed sync	×	○	×	×	×
Wireless flash	×	○	×	×	×

A: Built-in flash

B: AF360FGZ, AF500FTZ, AF330FTZ

C: AF400FTZ, AF240FT

D: AF400T, AF280T, AF220T, AF200T, AF080C, AF140C,
AF201SA, AF200SA

E: AF200S, AF160, AF140

MEMO

- *1. Available with the AF280T or AF400T only when the flash confirmation indicator in the viewfinder is off and TTL auto is set.
- *2. When using a type D flash (except AF200SA and AF201SA) in the MS (Manual Sync) or M (Manual) Mode or when using a Type E flash, set the camera exposure mode to the Aperture-Priority AE Mode, Metered Manual or Bulb. Picture mode and Shutter-priority AE cannot be used because the actual required aperture value may change.
- *3. Only applied to the AF360FGZ when an FA J, FA, F or A lens is used.
- *4. With the AF201SA and AF200SA, TTL auto cannot be used.
- *5. The shutter speed will be 1/60 sec. or slower.
- *6. With the combination of the built-in flash and the type B or C flash, trailing shutter curtain sync flash is possible.
- *7. Exception of AF360FGZ and AF330FTZ

Using P-TTL Auto Flash Mode with the AF360FGZ

Use this flash mode with the AF360FGZ flash unit.



The optimum flash amount is discharged to match the subject's brightness.

P-TTL auto flash, which pre-fires the flash using the 16-segment metering, allows more precise control.

P-TTL is available with external wireless flash mode.

- 1. Remove the hot shoe cover F_K from the camera.**
- 2. Attach the flash unit to the hot shoe.**
- 3. Turn the external flash ON.**
- 4. Set the flash mode switch to P-TTL auto.**
- 5. Confirm that the flash is fully charged.**
- 6. Focus on the subject and take a picture.**

MEMO

- The P-TTL is available with the AF360FGZ flash unit only. When other than the AF360FGZ flash unit is set, set the camera into the TTL flash mode.
- When the flash is ready (fully charged), the  will light in the viewfinder when the shutter release button is pressed halfway down.
- If  is lit in on the LCD panel, the external flash also discharges automatically. If the subject is bright enough, the flash does not discharge (therefore, may not suitable for daylight-sync shooting).
- Never press the flash pop up button when any external flash unit is attached to this camera. The built-in flash will pop up and strike the external flash. If you want to use any external flash and built-in flash at the same time, see page 124.
- Read the operating manual of the flash unit for more details.

Using High-Speed Sync Flash Mode with the AF360FGZ

With the AF360FGZ, you can use a flash sync speed faster than 1/125 sec. High-speed sync flash mode can also be used while the flash unit is attached to the camera or in a wireless configuration.

Using hi-speed sync flash on the camera

1. Remove the hot shoe cover F_K from the camera.
2. Attach the flash unit to the hot shoe.
- 3 Set the mode dial to M, Av or TV.
- 4 Turn on the external flash unit.
5. Set the flash unit's sync mode switch to HS (high-speed sync.).
6. Confirm that the flash is fully charged.
7. Focus on the subject and take the picture.

MEMO

- When the flash is ready (fully charged), the  will light in the viewfinder when the shutter release button is pressed halfway down.
- The High-speed sync flash mode is only available when the shutter speed is faster than 1/125 sec.
- The High-speed sync flash mode does not work in the auto picture mode and the picture mode.
- Read the operating manual of the flash unit for more details.

USING EXTERNAL FLASH

Using wireless High-speed sync flash with the AF360FGZ

1. Place the flash unit at the desired location.
2. Set the flash unit's power switch to [WIRELESS]
3. Set the flash unit's sync mode switch to HS (high-speed sync.).
4. Set the wireless mode switch to S (Slave).
5. Press the flash pop-up button to enable the built-in flash to be used.
6. Press the flash mode button until  is displayed.
7. Confirm that both the built-in flash and external flash unit are fully charged.
8. Focus on the subject and take the picture.

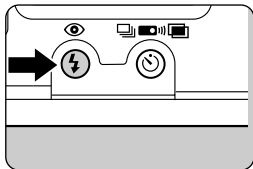

MEMO

- When the built-in flash is ready (fully charged), the  will light in the viewfinder when the shutter release button is pressed halfway down.
- The high-speed sync is only available when the shutter speed is faster than 1/125 sec.
- Read the operating manual of the flash unit for more details.

Wireless Flash (AF360FGZ Only)

With the AF360FGZ, you can discharge a flash without having a cord connection between the camera and flash unit. The high-speed sync mode can also be used with wireless flash. See page 120.

1. Place the flash unit at the desired location.
2. Set the flash unit's power switch to [WIRELESS]
3. Set the flash unit's sync mode switch to S (Slave).
4. Press the flash pop-up button to enable the built-in flash to be used.
5. Press the flash mode button until  is displayed.
6. Confirm that both the built-in flash and external flash unit are fully charged.
7. Focus on the subject and take the picture.

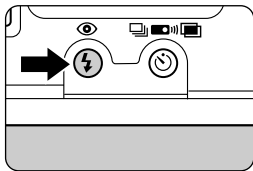

MEMO

- When the flash is ready (fully charged), the  will light in the viewfinder when the shutter release button is pressed halfway down.
- Read the operating manual of the flash unit for more details.
- The AF360FGZ can be attached directly to the camera hot shoe and used instead of the built-in flash. It can also be controlled in wireless mode.

USING EXTERNAL FLASH

Wireless flash control (P-TTL flash mode)

When the AF360FGZ is used for wireless flash, the following process is executed between the built-in flash and AF360FGZ before the flash is fired.

1. Press the shutter release button completely.
2. The built-in flash discharges a pre-flash (the camera's flash mode is transmitted).
3. The external flash unit discharges a pre-flash (the subject's lighting condition is checked).
4. The external flash unit discharges a pre-flash (the required flash output is transmitted to the external flash).



If HS (high-speed sync) has also been set, the built-in flash will discharge another pre-flash to transmit the flash duration time.

5. The AF360FGZ flash unit discharges the flash.

MEMO

- You can select how the built-in flash is to be used: either as an information controller for the external flash, or as a flash to affect the exposure using the custom function number [CF8]. See pages 134 and 139.

Channel control

- For wireless control, channel (e.g. CH1) for the AF360FGZ must be set on the camera. Attach the AF360FGZ to the camera, turning on the camera and pressing the shutter release button halfway down to set channel.
- The present channel is displayed for about 10 seconds when flash mode  or  is set.

Contrast-Control-Synch Flash

Using the dedicated external flash in combination with the built-in flash allows twin flash photography (contrast-control-synch flash photography). This is based on the difference between the amounts of light discharged from two units.

Contrast control synch flash is possible with the combination of following flash units:

AF360FGZ, AF330FTZ, AF500FTZ and the built-in flash

1. Place the flash unit a part from the camera.

Refer to page 124 for connecting the dedicated external flash.

2. Press the flash pop up button to activate the built-in flash.

3. Set the flash synch mode to the Contrast-Control-Synch mode.

4. Confirm that both flash units are fully charged and then press the shutter release button to take a picture.

MEMO

- The ratio of the amount of flashlight is 1 (built-in flash): 2 (dedicated flash unit).
- Do not combine an accessory with a different number of contacts such as a “Hot Shoe Grip” as a malfunction may occur.
- In the Contrast-Control-Synch Mode, the fastest flash synchronization speed is 1/60 second.

Using Both the Built-in Flash and External Flash

To use the built-in flash and dedicated external flash simultaneously, follow the procedure below.

The following accessories (sold separately) are required.

Hot Shoe Adapter F_G, Off-Camera Shoe Adapter F, Extension Cord F5P

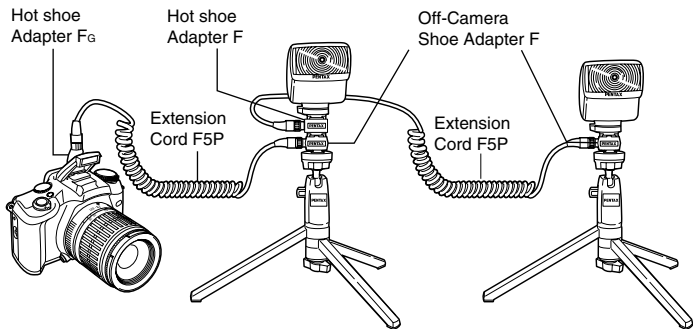
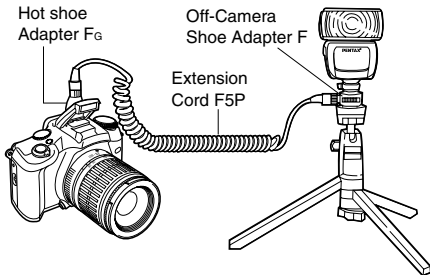

1. Remove the hot shoe cover F_k from the camera.
2. Attach the hot shoe adapter F_G to the camera.
3. Connect the extension cord F5P to the hot shoe adapter F_G.
4. Attach the Off-Camera shoe adapter F to a tripod.
5. Connect the extension cord F5P to the Off-camera shoe adapter F.
6. Press the flash pop up button to activate the built-in flash.
7. Confirm that the all flash units are fully charged.
8. Focus on the subject and take a picture.

MEMO

- The AF500FTZ can be connected directly to the Extension cord F5P without Off-camera shoe adapter F.
- The AF400T flash cannot be used with the built-in flash simultaneously because the 4P sync cord B from the AF400T will interrupt the function of the built-in flash.

Red-eye Reduction Flash Function

The red-eye reduction flash function with an external flash attached can also be used depending on what type of an external flash is attached, and it may have any restrictions for usage. See pages 116 and 117 for more details.

Trailing-Shutter-Curtain Sync Flash

When using the built-in flash and the external flash simultaneously, the trailing-shutter-curtain-flash function for the built-in flash also operates when the external flash is set to the trailing-shutter-curtain flash function. Before shooting, confirm that both flash units are fully charged.

Multi-burst Flash with the Pentax Dedicated Flash

When using more than one external flash, make sure that they are of the same type or a combination of type B and type C or type C and type D as described on pages 116 and 117. Refer to the second illustration on page 124. The built-in flash can be operated with any type of Pentax TTL dedicated flash unit 2.

4

OTHERS

BASIC OPERATION
(PREPARATION)

BASIC OPERATION
(SHOOTING)

ADVANCED OPERATIONS

OTHERS

ACCESSORIES (OPTIONAL)

A number of dedicated accessories are available for this camera.

AA-Battery Grip BG-20

Battery grip powered by size-AA batteries. Usability is enhanced with the shutter release and AE lock buttons for vertical positioning of the camera.

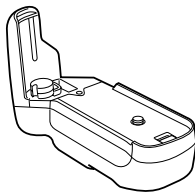

Battery life (Using 24-Exposure film rolls)

The number of 24-exposure film rolls that can be taken with a new set of alkaline batteries is indicated below.

	Number of film rolls at 20°C(68°F)
General existing light photography	approximately 75 rolls
Flash photography with 50% of shooting uses flash	approximately 30 rolls
Flash photography with 100% of shooting uses flash	approximately 20 rolls
Bulb exposure time	approximately 12 hours

When you use the camera in cold climates, it is recommended that you use the camera without the BG-20, since the performance of alkaline batteries, such as those used in the BG-20, deteriorates in cold environments.

Cable Switch

Cable switch CS-205

Lengths:0.5m

Download from Www.Somanuals.com. All Manuals Search And Download.

Flash Accessories

AF360FGZ

A P-TTL/TTL auto zoom flash unit with maximum guide number 36 (ISO 100/m). Its features include AF spot beam, slave-sync flash, multiple-flash, high-speed sync, wireless flash, contrast-control-sync flash, and leading/trailing curtain-sync modes.

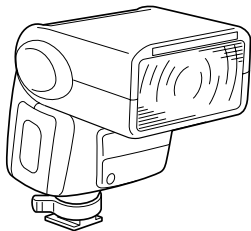

AF500FTZ

A TTL Auto Zoom flash with a built-in AF spot beam and maximum guide number 50 (ISO 100/m). It features the slave-sync flash function, multiple-flash, contrast-control-sync flash, and leading/trailing-curtain-sync flash mode.

AF220T

A TTL Auto flash with a guide number of 22 (ISO 100/m).

AF201SA

An Auto flash (Not TTL) with a guide number of 20 (ISO 100/m).

Macro Flash AF140C

A TTL macro flash unit with a guide number of 14 (ISO 100/m).

Off-Camera shoe Clip CL-10

Enable the AF360FGZ to be used as a wireless slave flash.

ACCESSORIES (OPTIONAL)

Hot Shoe Adapter F₆, Extension Cord F5P and Off-Camera shoe Adapter F

The adapters and cords to use the external flash away from the camera.

Viewfinder and Lens Accessories

Magnifier FB

A viewfinder accessory for magnifying the central area of the viewfinder.

Refconverter A

Right-angle finder, which attaches to the grooves on both sides of the viewfinder. The viewfinder magnification is able to switch from 1X to 2X.

MEMO

- Be sure to detach the Refconverter A before you open the camera back cover, otherwise the back cover may strike the Refconvert A.

Filters

Skylight, UV, Cloudy, Y2, O2, R2, and Circular Polarizing Filter are available in sizes of 49mm, 52mm, 58mm, 67mm and 77mm.

MEMO

- The hot shoe cover attached to the camera hot shoe is dedicated only for **ist*, MZ-L, MZ-30 and MZ-7. If you use any hot shoe cover of other than the above models, auto pop-up doesn't operate.

Diopter correction lens adapter M

Diopter correction lenses that slide into the eyepiece groove on the camera are available.

If it is difficult to see the viewfinder image clearly, choose one of the eight correction lenses M of -5, -4, -3, -2, -1, +1, +2 and +3 m⁻¹.

Eyecup F_M



Camera Cases

Soft case CF-12



Strap

Strap F_M

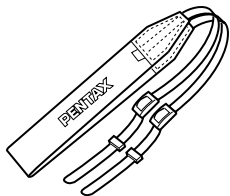

About Polarizing Filter

When using an ordinary polarizing filter; the half mirror incorporated into the autofocus system reduces the effectiveness of the autofocus function when used in combination with an ordinary polarizing filter. Use a CIRCULAR POLARIZING FILTER for proper autofocus operation.

CUSTOM FUNCTIONS

The camera provides 17 custom functions so you can set the camera according to your shooting preferences.

NO.	Setting	Pages
Exposure Functions		
[CF1]	Setting the auto bracketing sequence	136
[CF2]	Setting the shooting mode after auto bracket shooting	137
[CF3]	Setting AF/AE at the focus point	137
[CF4]	Setting the AF function to the AE lock button	137
[CF5]	Setting the film speed manually	138
Autofocus Functions		
[CF6]	Superimposing the focus points	138
Flash Functions		
[CF7]	Enabling shutter release before the built-in flash is fully charged.	138
[CF8]	Using the built-in flash as a wireless control for the AF360FGZ	139
[CF9]	Setting the flash pop-up button's function during wireless operation with the AF360FGZ	139
Film Rewind Functions		
[CF10]	Setting the film rewind method	139
[CF11]	Setting the status of the end of the film when rewind	140
Self-timer Functions		
[CF12]	Setting the self-timer delay time	140

NO.	Setting	Pages
Remote Control Functions		
[CF13]	Setting the shutter release delay time with the remote control	140
[CF14]	Setting auto focusing during remote control operation	141
Others		
[CF15]	Setting the LCD panel illumination	141
[CF16]	Setting the mode dial illumination	141
[CF17]	Enabling shutter release with the aperture ring set to other than the A position	142

Basic Setting of Custom Functions

Follow the procedure below to set a custom function.

- 1 Set the mode dial to CUSTOM .**
The custom function number and setting number will be displayed on the LCD panel.

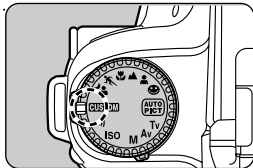

- 2 Use the four-way controller ▲ ▼ to select the custom function number you wish to set.**
The custom function number will be changed.

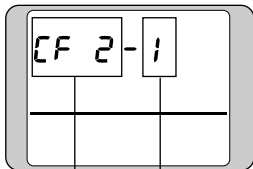
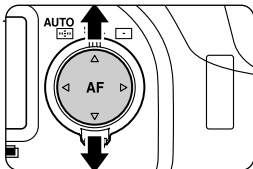

Setting number

Custom function number

3 Use the four-way controller to select the setting number.

The setting number will be changed.

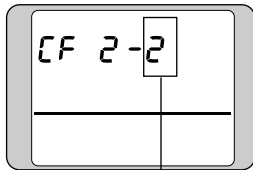
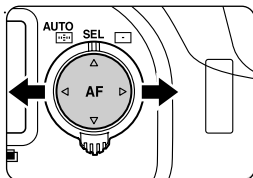

Setting number

- The LCD panel shows the custom function number [CF2] and setting number [2].

4 Set the mode dial to a position other than **CUSTOM** , and **ISO** .

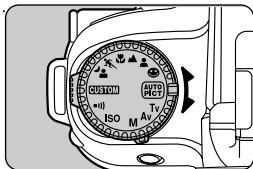

Resetting the custom functions to the default settings (Setting number [1]).

1. Set the mode dial to **CUSTOM** .
2. Hold down the AE lock button for more than 2 seconds.
[CF] and [CL] will be displayed on the LCD panel, and all the custom functions will be reset to default setting [1].
3. Set the mode dial to a position other than **CUSTOM** , **[M]]** and **[ISO]** .

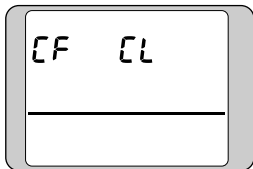

Setting the Custom Function

The setting for each custom function is explained below.
To display the custom function number and setting number, see “Basic Setting of Custom Functions” on page 134.

[CF1] Setting the auto bracketing sequence

- Custom Function number [CF1]
- Setting number
 - [1] . . . correct exposure → under exposure → over exposure
 - [2] . . . under exposure → correct exposure → over exposure
 - [3] . . . over exposure → correct exposure → under exposure



[CF2] Setting the shooting mode after auto bracket shooting

- Custom Function number [CF2]
- Setting number
 - [1] . . .Returns to single frame shooting
 - [2] . . .Remains in auto bracketing

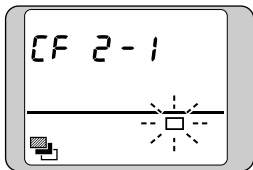

[CF3] Setting AF/AE at the focus point

The camera can automatically adjust the exposure according to the focused points when the camera is set to multi-segment metering mode.

- Custom Function number [CF3]
- Setting number
 - [1] . . .Does not link AF and AE
(AF only)
 - [2] . . .Links AF and AE

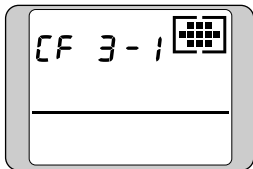

[CF4] Setting the AF function to the AE lock button

- Custom Function number [CF4]
- Setting number
 - [1] . . .The AE lock function is assigned to the AE lock button.
 - [2] . . .The AF function is assigned to the AE lock button.

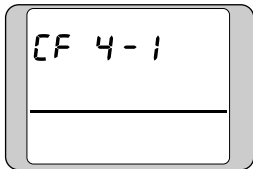

CUSTOM FUNCTIONS

[CF5] Setting the film speed manually

The film speed of DX-coded film can be set automatically or manually.

- Custom Function number [CF5]
- Setting number
 - [1]Sets film speed automatically
 - [2]Sets film speed manually

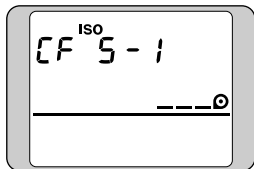

[CF6] Superimposing the focus points

- Custom Function number [CF6]
- Setting number
 - [1]Superimposes the focus points
 - [2]Disables the superimpose function

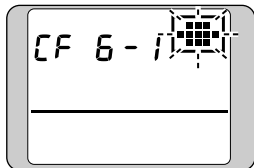

[CF7] Enabling shutter release before the built-in flash is fully charged

- Custom Function number [CF7]
- Setting number
 - [1]Disables shutter release until the flash is ready
 - [2]Enables shutter release before the flash is charged

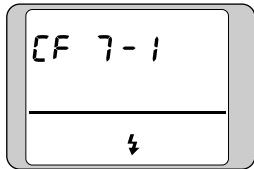

[CF8] Using the built-in flash as a wireless control for the AF360FGZ

When the AF360FGZ is used and the camera flash mode is set to wireless, you can assign the wireless control function to the built-in flash.

- Custom Function number [CF8]
- Setting number
 - [1] . . . Discharges the built-in flash to adjust the exposure
 - [2] . . . Built-in flash controls the AF360FGZ

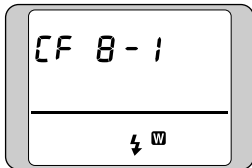

MEMO

- If you set [CF8] to [2], the built-in flash controls only the AF360FGZ and does not affect the exposure.

[CF9] Setting the flash pop-up button's function during wireless operation with the AF360FGZ

- Custom Function number [CF9]
- Setting number
 - [1] . . . Disables the built-in flash
 - [2] . . . Discharges the built-in flash once for a test
 - [3] . . . Discharges the built-in flash consecutively for modeling

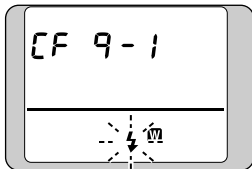

[CF10] Setting the film rewind method

- Custom Function number [CF10]
- Setting number
 - [1] . . . Automatically rewinds the film at the end of the roll
 - [2] . . . Disables automatic film rewind. To rewind the film, press the mid-roll rewind button (see page 51).

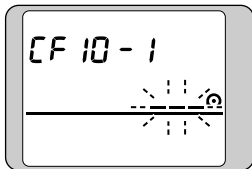

CUSTOM FUNCTIONS

[CF11] Setting the status of the end of the film when rewind

- Custom Function number [CF11]
- Setting number
 - [1]Rolls up the film completely
 - [2]Leaves the end of the film unwound

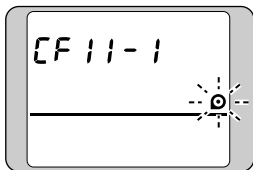

[CF12] Setting the self-timer delay time

- Custom Function number [CF12]
- Setting number
 - [1]Self-timer delay of 12 sec.
 - [2]Self-timer delay of 2 sec. with mirror lock-up

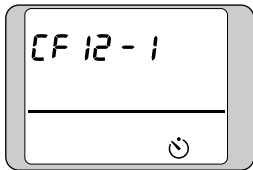

MEMO

- During normal picture taking, the shutter's reflex mirror goes up and creates a slight vibration. With mirror lock-up, the reflex mirror stays up before the exposure starts. This reduces camera shake caused by the mirror's movement. See page 58 for setting mirror lock-up.

[CF13] Setting the shutter release delay time with the remote control

- Custom Function number [CF13]
- Setting number
 - [1]Picture taken after 3 sec.
 - [2]Picture taken immediately

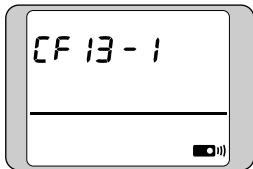

[CF14] Setting auto focusing during remote control operation

- Custom Function number [CF14]
- Setting number
 - [1]Auto focusing not used
 - [2]Auto focusing used

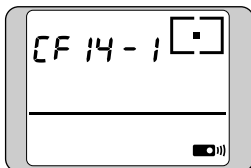

[CF15] Setting the LCD panel illumination

- Custom Function number [CF15]
- Setting number
 - [1]Illuminated when the main/preview switch is set to preview 
 - [2]Illuminated automatically in low light condition
 - [3]Not illuminated

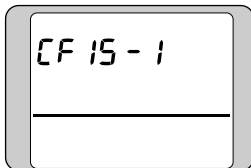

[CF16] Setting the mode dial illumination

- Custom Function number [CF16]
- Setting number
 - [1]Illuminates
 - [2]Does not illuminate

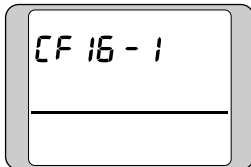

[CF17] Enabling shutter release with the aperture ring set to other than the **A** position

- Custom Function number [CF17]
- Setting number
 - [1]Disables shutter release if the aperture ring is not set to the **A** position
 - [2]Enables shutter release

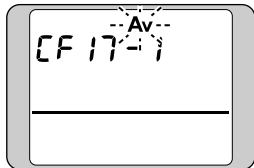



MEMO





- When the custom function number [CF17] is set to [2], the shutter can be released even if the aperture ring of an attached lens is not set to the **A** position. However, the features will be restricted as shown in the table on page 143.

Lenses	Exposure mode	Restriction
FA, F, A, M, S (lens only, or with auto diaphragm accessories such as auto extension tube K)	Aperture-Priority AE mode	The aperture remains wide open regardless of the aperture ring position. The shutter speed varies according to the aperture ring position, however, an exposure error may occur. Aperture value displays [F--] in the viewfinder and [AV--] on the LCD panel.
FA, F, A, M, S (with manual diaphragm accessories such as extension tube K)	Aperture-Priority AE mode	Pictures can be taken with the specified aperture value, however, an exposure error may occur.
Manual diaphragm lens, such as reflex lens (lens only)	Aperture-Priority AE mode	Aperture value displays [F--] in the viewfinder and [AV--] on the LCD panel.
FA, F Soft 85mm FA Soft 28mm (lens only)	Aperture-Priority AE mode	Pictures can be taken with the aperture value manually specified, however, an exposure error may occur. Aperture value displays [F--] in the viewfinder and [AV--] on the LCD panel.
All lenses	Metered Manual	Pictures can be taken with the specified aperture value and shutter speed, however, the built-in light meter does not operate, therefore, the exposure cannot be evaluated. Aperture value displays [F--] in the viewfinder and [AV--] on the LCD panel.

TROUBLESHOOTING

What appears troublesome may be easily remedied. Here are some problems that may occur and their remedies. Before contacting a Pentax service center, check the following items.

Symptoms	Causes	Remedies	Reference
The shutter does not release. Nothing is displayed on the LCD panel.	The lens aperture ring is set to other than the [A] position.	Set the lens aperture ring to the [A] position.	p. 15
	The main switch is OFF.	Turn the main switch ON.	p. 27
	The low battery warning  is blinking.	Replace the battery.	p. 23
	The batteries are installed upside-down.	Install the batteries properly.	p. 23
	[ISO] and film speed are displayed on the LCD panel.	Set the Exposure mode other than ISO.	p. 52
	The built-in flash is being charged.	Wait until the flash is fully charged.	p. 102
Nothing is displayed on the LCD panel.	The main switch is OFF.	Turn the main switch ON.	p. 27
	No battery has been installed.	Install the batteries.	p. 23
	The batteries are installed backwards.	Install the batteries properly.	p. 23
	The battery is dead.	Replace the batteries.	p. 23
The Autofocus does not work.	The focus points  are not placed over the subject.	Move the camera until the focus points  cover the subject.	p. 48
	The subject is too close.	Increase the camera-to-subject distance.	p. 48
	The focus mode is set to [MF] or [AFC] .	Set the focus mode switch to [AFS] .	p. 43
	The subject is difficult to autofocus.	Focus manually by using the matte field.	p. 94

Symptoms	Causes	Remedies	Reference
AE lock function does not operate.	The Metered Manual Mode or Bulb Timer Exposure Mode is being used.	Set the exposure mode dial to the other position.	p. 67 p. 76 p. 78
Focus indicator  in the viewfinder blinks.	The subject is too close or difficult to autofocus.	Focus manually by using the matte field.	p. 94
The built-in flash does not charge.	Low battery warning  on the LCD panel blinking.	Replace the batteries.	p. 23
The built-in flash does not activate when the flash-pop up button is depressed.	The exposure mode is being set to  .	Set the mode dial other than  .	p. 104
The built-in flash does not pop up automatically.	The mode dial is set to other than the Auto picture or Picture mode.	Set the exposure mode dial to the Auto picture or Picture mode.	p. 66
	Hot shoe cover is used other than Fk	Use the Hot shoe cover Fk.	p. 130
The built-in flash does not discharge even if the flash is in the popped-up position.	When the  AUTO appears on the LCD panel, the built-in flash does not discharge in bright lighting conditions.		p. 45
The power zoom system does not function.	The camera does not have the power zoom function.		p. 18
The film does not rewind automatically when finished.	The custom function [CF10] has been set to the setting number [2].	For automatic rewind when the film is finished, set the custom function [CF10] to [1].	p. 139

- In rare cases, the camera may not operate correctly due to static electricity. This can be remedied by taking the batteries out and putting them back in again.
- When the mirror remains in the upper position, take the batteries out and put them back in again. Then, turn the power on, and turn the power off with pressing the shutter release button. After the procedure is done, the camera may operate correctly.

PROGRAM DIAGRAMS

Standard program Mode / Night Scene Program Mode without Flash
At ISO 100 with FA J 28 - 80mm f/3.5 - 5.6 AL lens

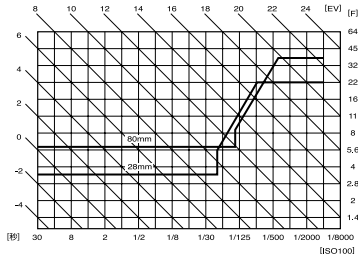

Portrait Program Mode At ISO with FA J 28 - 80mm f/3.5 - 5.6 AL lens

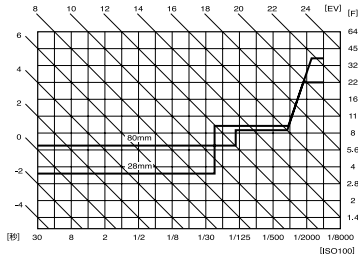

Landscape Program Mode At ISO 100 with FA J 28 - 80mm f/3.5 - 5.6 AL lens

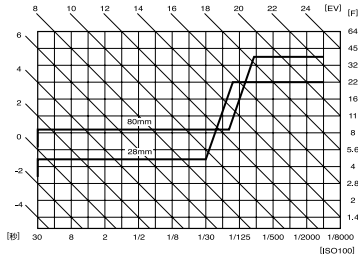



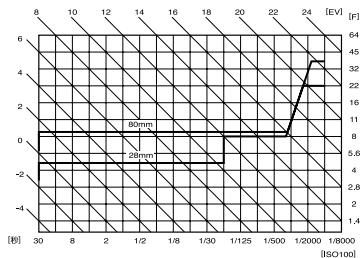



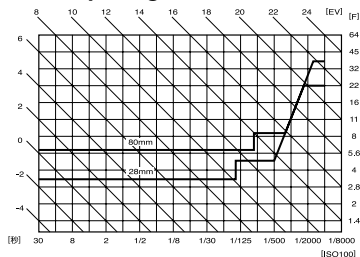



















Action Program Mode At ISO 100 FA J 28 - 80mm f/3.5 - 5.6 AL lens





Close-up Program Mode At ISO 100 FA J 28 - 80mm f/3.5 - 5.6 AL lens



SPECIFICATIONS TABLE

Type	TTL autofocus, auto-exposure 35mm SLR with built-in TTL auto flash (RTF)
Format	24x36mm
Usable Film	35mm perforated cartridge film. DX-coded film with ISO 25-5000; non-DX coded films with ISO 6-6400
Exposure Modes	Auto Picutre Mode, Picture Mode (Standard Program Mode, Portrait Program Mode, Landscape Program Mode, Close-up Program Mode, Action Program Mode, Night-scene Program Mode), Shutter-Priority AE Mode, Aperture-Priority AE Mode, Metered Manual Mode, Bulb Mode, TTL Flash Mode
Shutter	Electronically controlled vertical-run focal-plane shutter, Electromagnetic release, Speed range (1) Auto 1/4000-30 sec. (step less), (2) Manual 1/4000-30 sec. (1/2 steps) (3) Bulb Shutter lock by setting Main switch in OFF position.
Body Mount	Pentax K _{AF} bayonet mount (K-mount with AF coupler, lens information contacts)
Compatible Lens	Pentax K _{AF2} , K _{AF} mount lenses, K _A mount lenses
Autofocus System	TTL phase-matching autofocus system, AF operational brightness range: EV -1 to 18 (at ISO 100 with f/1.4 lens), Focus lock available using shutter release button, Focus Mode: AF.S (single)/AF.C (predictive continuous) / MF (manual)
Viewfinder	Penta-mirror finder, Natural-Bright-Matte focusing screen, Field of view: 90%, Magnification 0.7X(with 50mm f/1.4 lens at ∞), Diopter: -2 to +1.0 m ⁻¹
Viewfinder Indication	Focus Information: In-focus (Green lamp  is lit), front or back focus signals and unable-to-focus indicator (Green lamp  blinks), Shutter speed indication, Aperture indication, Flash ready indication  is lit, Bar graph (exposure compensation, Over or Under exposure indication in Metered Manual Mode, exposure compensation indication), Picture mode ( Standard Program,  Portrait Program,  Landscape Program,  Close-up Program,  Action Program,  Night-Scene Program),  AE lock indication
External LCD	 is lit=Built-in flash ready,  Blinking=Flash recommended warning or inappropriate lens warning,  =Flash-off,  =Red-eye reduction,  =Auto pop up flash, Automatic flash function,  =Consecutive shooting,  =Self-timer,  =Auto bracketing mode,  =Exposure compensation, Exposure compensation value,  =Multiple exposure,  =Remote control mode,  =PCV signal indication,  =Wireless flash mode,  =High-speed flash sync, Shutter speed, Aperture value, ISO, Date, Time, Exposure counter,  =Battery exhaustion warning,  =Film status information
Preview	Electronically controlled and usable in all exposure modes

- Self-timer** — Electronically controlled with delay time of 12 sec. or or 2 sec. with mirror lock up in used. Start by pressing shutter release button. Operation confirmation: Possible to set PCV beep tone. Cancellable after operation
- Auto Bracket** — Three frames consecutive shots with exposure bracketing in ± 0.3 , ± 0.5 ± 1 EV
- Mirror** — Quick-return mirror with AF secondary mirror
- Film Loading** — Film advances automatically to 1st frame after back cover is closed. Film information window is provided.
- Film Wind & Rewind** — Auto wind/rewind by built-in motor, Consecutive or Single advance mode, Approx. 2.5 frame/sec. (consecutive mode), Auto rewinding starts at end of roll, Film rewind/completion of rewinding is displayed on the LCD panel, Mid-roll rewind
- Exposure Meter** — TTL multi(16)-segment metering, Metering range from EV0 to EV21 at ISO100 with 50mm f/1.4 lens, Center-weighted and Spot metering mode can be set.
- Exposure Compensation** — ± 3 EV in 0.5 EV step increments
- AE lock** — Exposure is memorized for 20 seconds
- Flash** — Series-control, Auto-popup TTL Auto Flash (RTF), Guide number: 11 (ISO100/m), Illumination angle covers 28mm lens angle of view, Flash-sync-shutter in the range from 1/125 sec. to a slower speed, Day-light-sync flash, Slow-shutter-sync flash, Contrast-control-sync flash (ISO range = 25 – 800), Automatic flash function (automatically retracted when the power is turned off), Red-eye reduction flash function
- Flash sync** — Hot shoe with X-contact, which couples with Pentax dedicated auto flashes, ISO range = 25-800, Automatic flash, Red-eye reduction flash function. Possible to use high-speed sync, wireless flash mode, P-TTL mode with AF360FGZ.
- Custom Function** — 17 functions can be set.
- Power Source** — Two 3V lithium batteries (CR2 or equivalent), auto power off after 3 min.
- Battery Exhaustion** — Battery exhaustion symbol  is lit. (The shutter is locked and no indication in the viewfinder when  starts blinking.)
- Date module** — Crystal quartz controlled, LCD with digital clock, auto calendar, Imprinting mode 1 Year/Month/Day 2 Day/Hour/Minute
3 “----” (No imprint) 4 Month/Day/Year
5 Day/Month/Year
ISO range ISO 25-5000 (Automatic setting)
- Dimension and Weight** — 122mm (W) x 84mm (H) x 63.5mm (D) (4.8"x3.3"x2.5")
335g (11.8 oz) body only without batteries

Specification for Remote Control (Optional)

- Remote control** — Infrared remote control. Starts after approx. 3 sec. by pressing the shutter release button on the remote control. The operating distance of the remote control is approx. 5 m from the front of the camera.
- Power source** — One 3V lithium battery (CR1620)
About 30,000 commands can be issued using the remote control. If the battery is exhausted, please have it replaced at your local Pentax Service center (there is a charge for this service).
- Dimension** — 22mm (W) x 53mm(H) x 6.5mm(D)
- Weight** — 7g

For customers in U.S.A.

BASIC OPERATION
(PREPARATION)BASIC OPERATION
(SHOOTING)

ADVANCED OPERATIONS

OTHERS

STATEMENT OF FCC COMPLIANCE

This device complies with Part 15 of the FCC Rules. Operation is subject to the following two conditions: (1) This device may not cause harmful interference, and (2) this device must accept any interference received, including interference that may cause undesired operation.

Changes or modifications not approved by the party responsible for compliance could void the user's authority to operate the equipment. This equipment has been tested and found comply with the limits for a Class B digital device, pursuant to part 15 of the FCC Rules. These limits are designed to provide reasonable protection against harmful interference in a residential installation. This equipment generates, uses and can radiate frequency energy and, if not installed and used in accordance with the instructions, may cause harmful interference to radio communications. However, there is no guarantee that interference will not occur in a particular installation. If this equipment does cause harmful interference to radio or television reception, which can be determined by turning the equipment off and on, the user is encouraged to try to correct the interference by one or more of the following measures:

- Reorient or relocate the receiving antenna Increase the separation between the equipment and receiver.
- Consult the dealer or an experienced radio/TV technician for help.

For customers in Canada

This Class B digital apparatus meets all requirements of the Canadian Interference - Causing Equipment Regulations.

WARRANTY POLICY

All Pentax cameras purchased through authorized bona fide photographic distribution channels are guaranteed against defects of material or workmanship for a period of twelve months from date of purchase. Service will be rendered, and defective parts will be replaced without cost to you within that period, provided the equipment does not show evidence of impact, sand or liquid damage, mishandling, tampering, battery or chemical corrosion, operation contrary to operating instructions, or modification by an unauthorized repair shop. The manufacturer or its authorized representatives shall not be liable for any repair or alterations except those made with its written consent and shall not be liable for damages from delay or loss of use or from other indirect or consequential damages of any kind, whether caused by defective material or workmanship or otherwise; and it is expressly agreed that the liability of the manufacturer or its representatives under all guarantees or warranties, whether expressed or implied, is strictly limited to the replacement of parts as hereinbefore provided. No refunds will be made on repairs by non-authorized Pentax service facilities.

Procedure During 12-month Warranty Period

Any Pentax which proves defective during the 12-month warranty period should be returned to the dealer from whom you purchased the equipment or to the manufacturer. If there is no representative of the manufacturer in your country, send the equipment to the manufacturer, with postage prepaid. In this case, it will take a considerable length of time before the equipment can be returned to you owing to the complicated customs procedures required. If the equipment is covered by warranty, repairs will be made and parts replaced free of charge, and the equipment will be returned to you upon completion of servicing. If the equipment is not covered by warranty, regular charges of the manufacturer or of its representatives will apply. Shipping charges are to be borne by the owner. If your Pentax was purchased outside of the country where you wish to have it serviced during the warranty period, the manufacturer's representatives in that country may charge regular handling and servicing fees. Notwithstanding this, your Pentax returned to

Custom Functions

Setting of Custom Functions

- 1** Set the mode dial to **CUSTOM**.

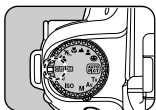

- 3** Use the four-way controller to select the setting number.

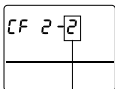
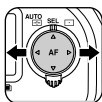

Setting number

- 2** Use the four-way controller to select the custom function number you wish to set.

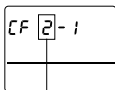
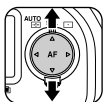



Custom Function number

To set the custom function
Use the four-way controller .

To set the setting number
Use the four-way controller .

Custom Functions

[CF1]	Setting the auto bracketing sequence
1	correct exposure → under exposure → over exposure
2	under exposure → correct exposure → over exposure
3	over exposure → correct exposure → under exposure
[CF2]	Setting the shooting mode after auto bracket shooting
1	Returns to single frame shooting
2	Remains in auto bracketing
[CF3]	Setting AF/AE at the focus point
1	Does not link AF and AE (AF only)
2	Links AF and AE
[CF4]	Setting the AF function to the AE lock button
1	The AE lock function is assigned to the AE lock button.
2	The AF function is assigned to the AE lock button.
[CF5]	Setting the film speed manually
1	Sets film speed automatically
2	Sets film speed manually

[CF6]	Superimposing the focus points
1	Superimposes the focus points
2	Disables the superimpose function
[CF7]	Enabling shutter release before the built-in flash is fully charged
1	Disables shutter release until the flash is ready
2	Enables shutter release before the flash is charged
[CF8]	Using the built-in flash as a wireless control for the AF360FGZ
1	Discharges the built-in flash to adjust the exposure
2	Built-in flash controls the AF360FGZ
[CF9]	Setting the flash pop-up button's function during wireless operation with the AF360FGZ
1	Disables the built-in flash
2	Discharges the built-in flash once for a test
3	Discharges the built-in flash consecutively for modeling
[CF10]	Setting the film rewind method
1	Automatically rewinds the film at the end of the roll
2	Disables automatic film rewind *To rewind the film, press the mid-roll rewind button.
[CF11]	Setting the status of the end of the film when rewind
1	Rolls up the film completely
2	Leaves the end of the film unwound
[CF12]	Setting the self-timer delay time
1	Self-timer delay of 12 sec.
2	Self-timer delay of 2 sec. with mirror lock-up
[CF13]	Setting the shutter release delay time with the remote control
1	Picture taken after 3 sec.
2	Picture taken immediately
[CF14]	Setting auto focusing during remote control operation
1	Auto focusing not used
2	Auto focusing used
[CF15]	Setting the LCD panel illumination
1	Illuminated when the main/preview switch is set to preview 
2	Illuminated automatically in low light condition
3	Not illuminated
[CF16]	Setting the mode dial illumination
1	Illuminates
2	Does not illuminate
[CF17]	Enabling shutter release with the aperture ring set to other than the  position
1	Disables shutter release if the aperture ring is not set to the  position

Free Manuals Download Website

<http://myh66.com>

<http://usermanuals.us>

<http://www.somanuals.com>

<http://www.4manuals.cc>

<http://www.manual-lib.com>

<http://www.404manual.com>

<http://www.luxmanual.com>

<http://aubethermostatmanual.com>

Golf course search by state

<http://golfingnear.com>

Email search by domain

<http://emailbydomain.com>

Auto manuals search

<http://auto.somanuals.com>

TV manuals search

<http://tv.somanuals.com>