

# RICOH

SLR Digital Camera

# PENTAX *K-S2*

## Start Guide

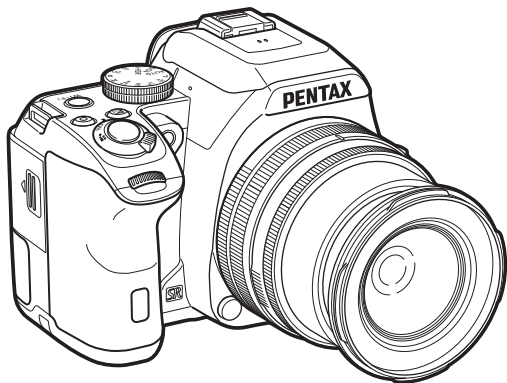

Thank you for purchasing the PENTAX K-S2 digital camera.

This Start Guide provides information on how to get your PENTAX K-S2 ready for use and its basic operations. To ensure proper operation, please read this Start Guide before using the camera.

For details on how to use the various shooting methods and settings, please refer to the Operating Manual (PDF) posted on our website. Refer to p.63 for details on the Operating Manual.

## Checking the Contents of the Package



Hot shoe cover Fk  
(Installed on camera)



Eyecup FR  
(Installed on camera)

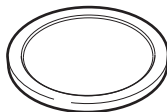

Body mount cover  
(Installed on camera)

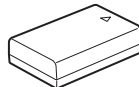

Rechargeable Lithium-ion  
Battery D-LI109

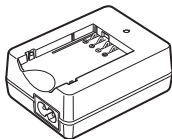

Battery charger  
D-BC109



AC plug cord

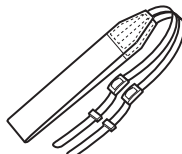

Strap  
O-ST132

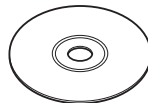

Software (CD-ROM)  
S-SW156



Start Guide (this manual)

### Lenses you can use

Lenses that can be used with this camera are DA, DA L, D FA and FA J lenses and lenses that have an **A** (Auto) position on the aperture ring. To use any other lens or accessory, see p.43.

# Contents

<b>Names and Functions of the Working Parts</b> .....	<b>3</b>
Operating Controls .....	4
Monitor .....	6
Viewfinder .....	9
Electronic Level .....	9
<b>How to Change Function Settings</b> .....	<b>10</b>
Using the Direct Keys .....	10
Using the Control Panel .....	10
Using the Menus .....	11
<b>Menu List</b> .....	<b>12</b>
Rec. Mode Menus .....	12
Movie Menu .....	15
Playback Menu .....	16
Set-up Menus .....	17
Custom Setting Menus .....	19
<b>Getting Your Camera Ready for Use</b> .....	<b>21</b>
Attaching the Strap .....	21
Attaching a Lens .....	21
Charging the Battery .....	22
Inserting/Removing the Battery .....	22
Inserting/Removing a Memory Card .....	23
Opening the Monitor .....	23
Setting the Display Language and Date/Time .....	24
Formatting a Memory Card .....	26
<b>Basic Shooting Operation</b> .....	<b>26</b>
Shooting with the Viewfinder .....	26
Shooting While Viewing the Live View Image .....	28
Capture Modes for Still Pictures .....	29
Setting the Sensitivity .....	32
Compensating the Exposure .....	33
Recording Movies .....	33
Setting the Flash Mode .....	34
Setting the Drive Mode .....	35
Setting the White Balance .....	36
<b>Reviewing Images</b> .....	<b>37</b>
Playing Back Movies .....	37
Playback Mode Palette .....	38
<b>Sharing Images</b> .....	<b>38</b>
Enabling the Wi-Fi Function .....	38
<b>Restrictions on Each Capture Mode</b> .....	<b>40</b>
Restrictions on the Combinations of Special Functions .....	42
<b>Functions Available with Various Lenses</b> .....	<b>43</b>
<b>Main Specifications</b> .....	<b>44</b>
Operating Environment for USB Connection and Provided Software .....	49
<b>Index</b> .....	<b>51</b>
<b>For Using Your Camera Safely</b> .....	<b>54</b>
<b>Care to be Taken During Handling</b> .....	<b>56</b>
<b>WARRANTY POLICY</b> .....	<b>60</b>
<b>Information on the Operating Manual</b> .....	<b>63</b>

There is a possibility that the illustrations and the display screen of the monitor in this manual are different from the actual ones.

### Regarding copyrights

Images taken with this camera that are for anything other than personal enjoyment cannot be used without permission according to the rights as specified in the Copyright Act. Please take care, as there are cases where limitations are placed on taking pictures even for personal enjoyment during demonstrations, performances or of items on display. Images taken with the purpose of obtaining copyrights also cannot be used outside the scope of use of the copyright as laid out in the Copyright Act, and care should be taken here also.

### To users of this camera

- Do not use or store this camera in the vicinity of equipment that generates strong electromagnetic radiation or magnetic fields. Strong static charges or the magnetic fields produced by equipment such as radio transmitters could interfere with the monitor, damage the stored data, or affect the camera's internal circuitry and cause camera misoperation.
- The liquid crystal panel used for the monitor is manufactured using extremely high precision technology. Although the level of functioning pixels is 99.99% or better, you should be aware that 0.01% or fewer of the pixels may not illuminate or may illuminate when they should not. However, this has no effect on the recorded image.
- In this manual, the generic term "computer(s)" refers to either a Windows PC or a Macintosh.
- In this manual, the term "battery(ies)" refers to any type of batteries used for this camera and its accessories.

### Regarding User Registration

In order to better serve you, we request that you complete the user registration, which can be found on the CD-ROM supplied with the camera or on our website. Thank you for your cooperation.





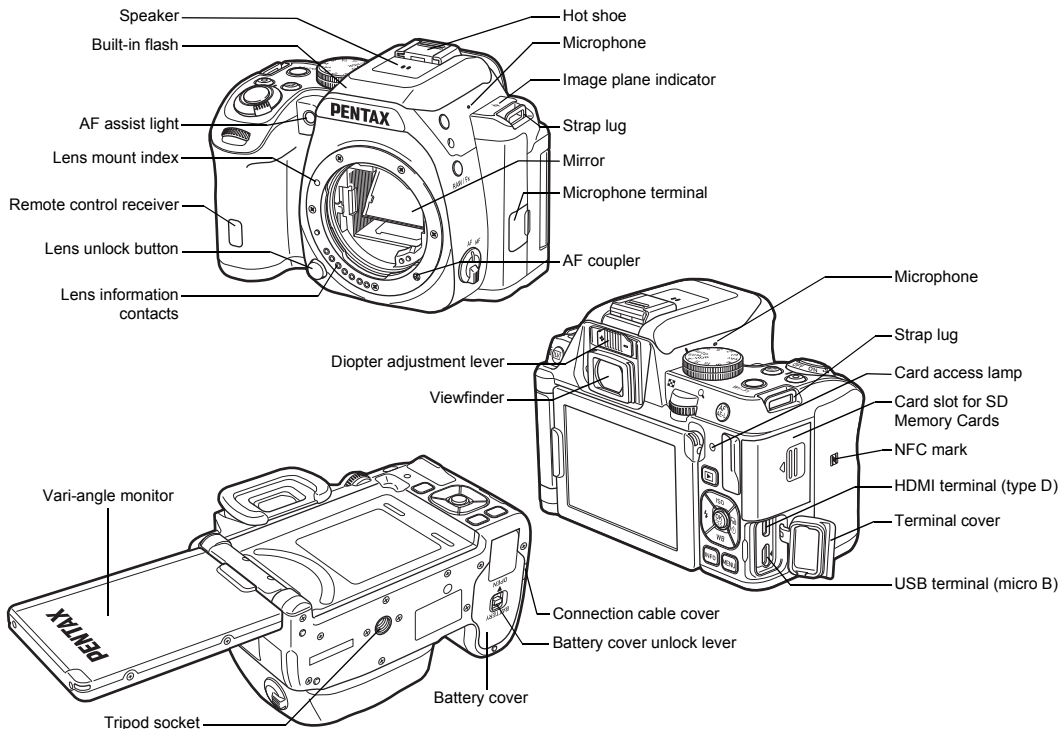



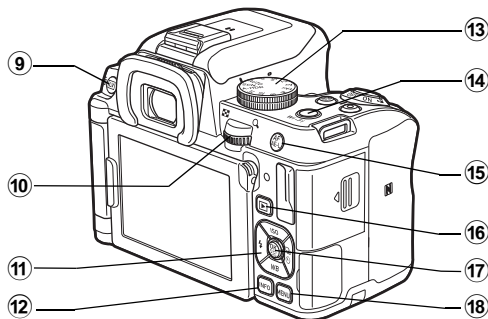
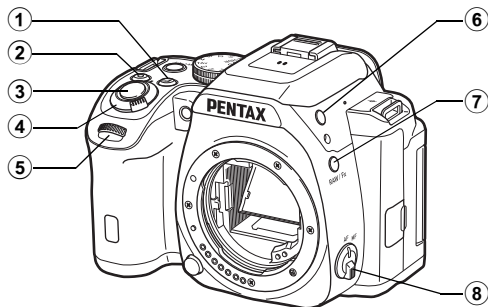

<http://www.ricoh-imaging.com/registration/>

# Names and Functions of the Working Parts



## Operating Controls



- 1 EV Compensation button (  )**  
Press to change the exposure compensation value. (p.33)  
In playback mode, the last JPEG image taken can also be saved in RAW format. (p.37)
- 2 Green button (  )**  
Resets the value being adjusted.
- 3 Shutter release button (  )**  
Press to capture images. (p.27)  
In playback mode, press halfway to switch to capture mode.
- 4 Main switch**  
Turns the power on/off, or switches to  (movie) mode. (p.24, p.33)  
When the camera is turned on, it enters  (still picture) mode and the indicator lamp lights green. When the switch is turned to , the camera enters  mode and the lamp lights red.
- 5 Front e-dial (  )**  
Changes the values for camera settings such as exposure. (p.32)  
You can change the menu category when a menu screen is displayed. (p.11)  
In playback mode, use this to select a different image.
- 6 Flash pop-up button (  )**  
Press to pop up the built-in flash. (p.35)
- 7 RAW/Fx button (  )**  
You can assign a function to this button.
- 8 Focus mode switch**  
Changes the focus mode. (p.27)
- 9 Live View/Delete button (  )**  
Displays the Live View image. (p.28)  
In playback mode, press to delete images. (p.37)

- 10 Rear e-dial** (🔍)
- Changes the values for camera settings such as exposure. (p.32)
- You can change the menu tabs when a menu screen is displayed. (p.11)
- You can change the camera settings when the control panel is displayed. (p.10)
- In playback mode, use this to magnify an image or display multiple images at the same time. (p.37)
- 11 Four-way controller** (▲▼◀▶)
- Displays the Sensitivity, White Balance, Flash Mode or Drive Mode setup menu. (p.10)
- When a menu or the control panel is displayed, use this to move the cursor or change the item to set.
- Press ▼ in single image display of the playback mode to display the playback mode palette. (p.38)
- 12 INFO button** (INFO)
- Changes the style of the display on the monitor. (p.6, p.8)
- 13 Mode dial**
- Changes the capture mode. (p.27)
- 14 Self-portrait shutter button**
- When shooting with Live View, this button can be used as a shutter release button and facilitates taking self-portraits by holding the camera with the lens facing you. The indicator lamp lights green or red when the button can be used as a shutter release button. (p.28)
- At all other times, this button is used to switch the Wi-Fi function on or off. (p.39)
- 15 AF/AE Lock button** (AF/AE-L)
- Available for adjusting focus, instead of pressing SHUTTER halfway, and for locking the exposure value before shooting.

- 16 Playback button** (▶)
- Switches to playback mode. (p.37)
- Press the button again to switch to capture mode.
- 17 OK button** (OK)
- When a menu or the control panel is displayed, press this button to confirm the selected item.
- When the power is turned on, the indicator lamp lights blue. The lamp turns off after a while.
- 18 MENU button** (MENU)
- Displays a menu. Press this button while the menu is displayed to return to the previous screen. (p.11)

#### About the four-way controller

In this manual, each button of the four-way controller is indicated as shown in the illustration on the right.

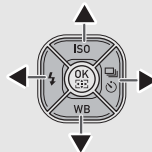

## Monitor

### Capture Mode

With this camera, you can take pictures while looking through the viewfinder or while viewing the image on the monitor.

When using the viewfinder, you can take pictures while checking the status screen displayed on the monitor and looking through the viewfinder. (p.26) When not using the viewfinder, you can take pictures while viewing the Live View image displayed on the monitor. (p.28)

The camera is in “standby mode” when it is ready to shoot, such as when the status screen or Live View image is displayed.

Press **INFO** in standby mode to display the “control panel” and change settings. (p.10) You can change the type of information displayed in standby mode by pressing **INFO** while the control panel is displayed.

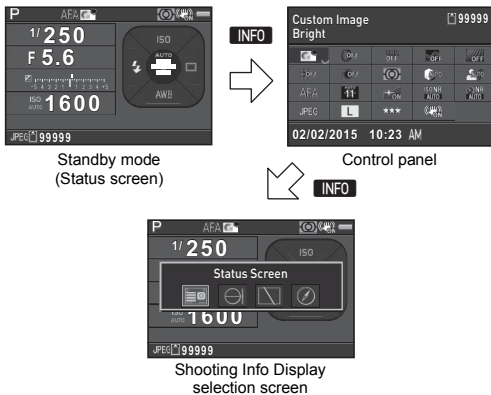



## Status Screen

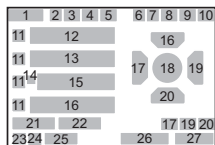
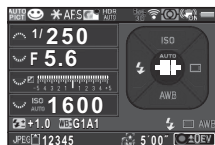

- |                                       |   |
|---------------------------------------|---|
| 1 Capture mode                        | 17 Flash Mode   |
| 2 AE Lock                             | 18 Focusing area (AF point)   |
| 3 Focus Method                        | 19 Drive Mode   |
| 4 Custom Image                        | 20 White Balance  |
| 5 Digital Filter/HDR Capture          | 21 Flash Exposure Compensation  |
| 6 GPS positioning status              | 22 White Balance fine-tuning  |
| 7 Wireless LAN status                 | 23 File Format  |
| 8 AE Metering                         | 24 Memory card  |
| 9 Shake Reduction/ Horizon Correction | 25 Image storage capacity   |
| 10 Battery level                      | 26 Number of shots during Multi-exposure, Interval Shooting, or Interval Composite/Maximum tracking duration of ASTROTRACER |
| 11 E-dial guide                       | 27 Operation guide  |
| 12 Shutter speed                      |   |
| 13 Aperture value                     |   |
| 14 EV Compensation/ Bracketing        |   |
| 15 EV bar scale                       |   |
| 16 Sensitivity                        |   |

## Live View

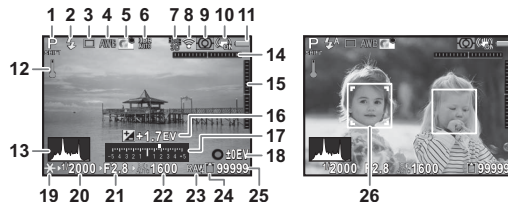

- |  |  |
|--|--|
| 1 Capture mode                                   | 15 Electronic Level (vertical tilt)  |
| 2 Flash Mode                                     | 16 EV Compensation   |
| 3 Drive Mode                                     | 17 EV bar scale  |
| 4 White Balance                                  | 18 Operation guide, and number of shots during Multi-exposure, Interval Shooting or Interval Composite |
| 5 Custom Image                                   | 19 AE Lock   |
| 6 Digital Filter/HDR Capture                     | 20 Shutter speed   |
| 7 GPS positioning status                         | 21 Aperture value  |
| 8 Wireless LAN status                            | 22 Sensitivity   |
| 9 AE Metering                                    | 23 File Format   |
| 10 Shake Reduction/ Horizon Correction/ Movie SR | 24 Memory card   |
| 11 Battery level                                 | 25 Image storage capacity  |
| 12 Temperature warning                           | 26 Face detection frame (when [Contrast AF] is set to [Face Detection])                                |
| 13 Histogram                                     |  |
| 14 Electronic Level (horizontal tilt)            |  |

## Control Panel

### mode

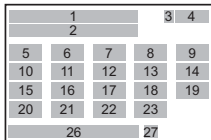
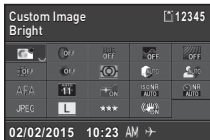

### When shooting with Live View

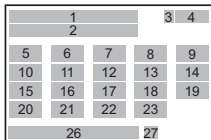
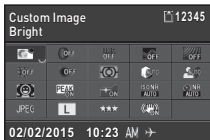

### mode

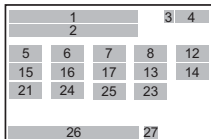
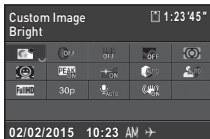

- |   |                                       |
|---|---------------------------------------|
| 1 Function name   | 7 HDR Capture                         |
| 2 Setting   | 8 Clarity Enhancement                 |
| 3 Memory card   | 9 AA Filter Simulator                 |
| 4 Number of recordable still pictures/Movie recordable time | 10 Distortion Correction              |
| 5 Custom Image/Scene Mode                                   | 11 Peripheral Illumination Correction |
| 6 Digital Filter  | 12 AE Metering                        |
|   | 13 Highlight Correction               |
|   | 14 Shadow Correction                  |

- |   |                             |
|---|-----------------------------|
| 15 AF Mode/Contrast AF                        | 22 JPEG Quality             |
| 16 AF Active Area/Focus Peaking               | 23 Shake Reduction/Movie SR |
| 17 AF Assist Light                            | 24 Framerate                |
| 18 High-ISO NR                                | 25 Recording Sound Level    |
| 19 Slow Shutter Speed NR                      | 26 Current date and time    |
| 20 File Format                                | 27 Destination              |
| 21 JPEG Recorded Pixels/Movie Recorded Pixels |                             |

## Playback Mode

The captured image and shooting information are displayed in single image display of the playback mode.

Press **INFO** to change the type of information displayed in single image display. Use **◀▶** to select the type and press **OK**.



Single image display (Standard Information Display)



Playback Info Display selection screen

## Viewfinder

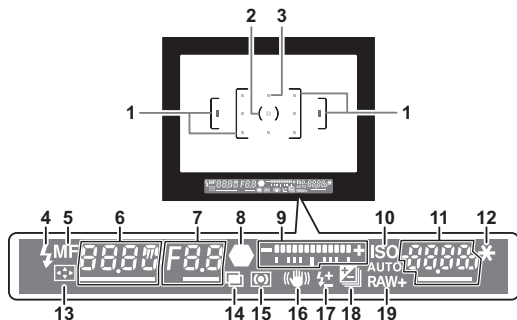

- |    |                               |    |   |
|----|-------------------------------|----|---|
| 1  | AF frame                      | 11 | Sensitivity/Exposure compensation value |
| 2  | Spot metering frame           | 12 | AE Lock                                 |
| 3  | AF point                      | 13 | Change AF Point                         |
| 4  | Flash indicator               | 14 | Multi-exposure                          |
| 5  | Focus Method                  | 15 | AE Metering                             |
| 6  | Shutter speed                 | 16 | Shake Reduction                         |
| 7  | Aperture value                | 17 | Flash Exposure Compensation             |
| 8  | Focus indicator               | 18 | EV Compensation/Bracketing              |
| 9  | EV bar scale/Electronic Level | 19 | File Format                             |
| 10 | ISO/ISO AUTO                  |    |   |

## Memo

- You can adjust the image sharpness in the viewfinder using the diopter adjustment lever. If it is difficult to move the diopter adjustment lever, lift up and remove the eyecup. Adjust the diopter setting until the AF frame in the viewfinder looks sharp and clear.

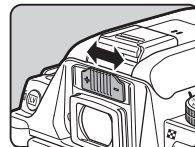

## Electronic Level

- You can check whether the camera is tilted by displaying the electronic level. The electronic level for the horizontal camera angle can be displayed in the EV bar scale in the viewfinder, and the electronic levels for the vertical and horizontal camera angles can be displayed on the Live View screen. (p.7)
- Select whether to display the electronic level in [Electronic Level] of the 3 menu. (p.13)

## How to Change Function Settings

The camera functions and their settings can be selected and changed by using the following ways.

<b>Direct keys</b>	Press <b>▲▼◀▶</b> in standby mode.
<b>Control panel</b>	Press <b>INFO</b> in standby mode. (indicated with the  icon in this manual)
<b>Menus</b>	Press <b>MENU</b> .

## Using the Direct Keys

<b>▲</b>	<b>Sensitivity</b>	p.32
<b>▼</b>	<b>White Balance</b>	p.36
<b>◀</b>	<b>Flash Mode</b>	p.34
<b>▶</b>	<b>Drive Mode</b>	p.35

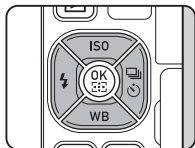



## Using the Control Panel

INFO

You can set frequently used shooting functions. Press **INFO** in standby mode.

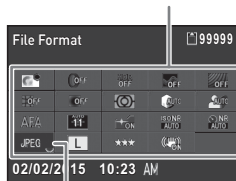
Use **▲▼◀▶** to select an item.



Use  to change settings.

Press **OK** to make detailed settings.

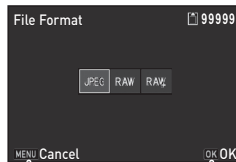

Press **MENU** to cancel the setting operation.

Press **OK** to confirm the selected item and return to the control panel.

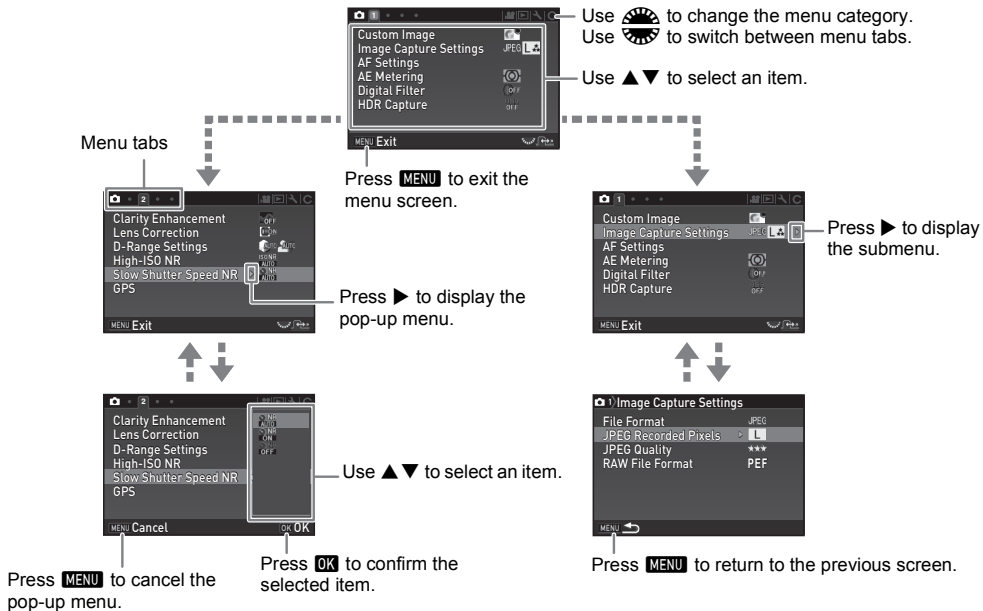

Most functions are set from the menus. The functions that can be set on the control panel can also be set from the menus.

















# Menu List



## Rec. Mode Menus

Menu	Item	Function	Default Setting	
 1	<b>Exposure Mode</b> *1	Temporarily changes the exposure mode when the mode dial is set to <b>U1</b> or <b>U2</b> .	<b>P</b>	
	<b>Custom Image</b> *2 *4	Sets the image finishing tone such as color and contrast before shooting an image.	Bright	
	<b>Scene Mode</b> *3 *4	Selects the scene mode that best suits the situation. ( <b>SCN</b> mode)	Portrait	
	<b>Image Capture Settings</b>	<b>File Format</b> *4	Sets the file format of images.	JPEG
		<b>JPEG Recorded Pixels</b> *4	Sets the recording size of JPEG images.	[L]
		<b>JPEG Quality</b> *4	Sets the quality of JPEG images.	★★★
		<b>RAW File Format</b>	Sets the RAW file format.	PEF
	<b>AF Settings</b>	<b>AF Mode</b> *4	Selects the autofocus method when shooting with the viewfinder.	<b>A.F.A</b>
		<b>AF Active Area</b> *4	Selects the area to adjust the focus when shooting with the viewfinder.	Auto (11 AF Points)
		<b>AF Assist Light</b> *4	Discharges the assist light when autofocusing in dark locations.	On
	<b>AE Metering</b> *4	Selects the part of the sensor to use for measuring brightness and determining exposure.	Multi-segment	
	<b>Digital Filter</b> *4	Applies a digital filter effect when taking pictures.	No Filter	
	<b>HDR Capture</b>	<b>HDR Capture</b> *4	Sets the type of high dynamic range shooting.	Off
		<b>Bracket Value</b> *4	Sets the amount to change the exposure.	±2EV
<b>Auto Align</b>		Sets whether to automatically adjust the composition.	On	

Menu	Item	Function	Default Setting	
	<b>Clarity Enhancement</b> *4		Enhances the texture and surface details of the subject.	Off
	<b>Lens Correction</b>	<b>Distortion Correction</b> *4	Reduces distortions occurring due to lens properties.	Off
		<b>Peripheral Illumin. Corr.</b> *4	Reduces peripheral light fall-off occurring due to lens properties.	Off
		<b>Lat-Chromatic-Ab Adj</b>	Reduces lateral chromatic aberrations occurring due to lens properties.	On
		<b>Diffraction Correction</b>	Corrects blur caused by diffraction when using a small aperture.	On
	<b>D-Range Settings</b>	<b>Highlight Correction</b> *4	Expands the dynamic range and prevents overexposed areas from occurring.	Auto
		<b>Shadow Correction</b> *4	Expands the dynamic range and prevents underexposed areas from occurring.	Auto
	<b>High-ISO NR</b> *4		Sets the Noise Reduction setting when shooting with a high ISO sensitivity.	Auto
	<b>Slow Shutter Speed NR</b> *4		Sets the Noise Reduction setting when shooting with a slow shutter speed.	Auto
	<b>GPS</b>		Sets the camera action when the optional GPS unit is used.	–
	<b>Live View</b>	<b>Contrast AF</b> *4	Sets the autofocus mode for shooting with Live View.	Face Detection
		<b>Focus Peaking</b> *4	Emphasizes the outline of the subject in focus and makes it easier to check the focus.	Off
		<b>Grid Display</b>	Displays the grid during Live View.	Off
		<b>Histogram Display</b>	Displays the histogram during Live View.	Off
		<b>Highlight Alert</b>	Sets overexposed areas to blink red during Live View.	Off
	<b>Electronic Level</b>	<b>Viewfinder</b>	Displays the electronic level in the EV bar scale in the viewfinder.	Off
		<b>Live View</b>	Displays the electronic level in Standard Information Display of Live View.	On
	<b>Horizon Correction</b>		Corrects horizontal tilt when in  mode.	Off
	<b>AA Filter Simulator</b> *4		Applies a low-pass filter effect using the Shake Reduction mechanism.	Off
	<b>Shake Reduction</b> *4		Activates the Shake Reduction function.	On
<b>Input Focal Length</b>		Sets the focal length when using a lens of which focal length information cannot be obtained.	35mm	

Menu	Item	Function	Default Setting		
 4	Instant Review	Display Time	Sets the Instant Review display time.	1sec.	
		Zoom Review	Displays the magnified image during Instant Review.	On	
		Save RAW Data	Saves the RAW data during Instant Review.	On	
		Delete	Deletes the displayed image during Instant Review.	On	
		Histogram Display	Displays the histogram during Instant Review.	Off	
		Highlight Alert	Sets overexposed areas to blink red during Instant Review.	Off	
	E-Dial Programming	P	Sets the  /  /  operation for each exposure mode.	<b>Tv, Av, <math>\rightarrow</math>P</b>	
		Sv		-, ISO, -	
		Tv		<b>Tv, -, -</b>	
		Av		-, <b>Av, -</b>	
		TAv		<b>Tv, Av, P<sup>LINE</sup></b>	
		M		<b>Tv, Av, P<sup>LINE</sup></b>	
		B		-, <b>Av, -</b>	
		  P		-, -, -	
		  Av		-, <b>Av, P<sup>LINE</sup></b>	
		  Av		<b>Tv, Av, P<sup>LINE</sup></b>	
		  M		<b>Tv, Av, P<sup>LINE</sup></b>	
		Rotation Direction		Reverses the effect obtained when  or  is turned.	Rotate Right



Menu	Item		Function	Default Setting
 4	<b>Button Customization</b>	<b>RAW/Fx Button</b>	Sets the function for when <b>RAW/Fx</b> is pressed.	One Push File Format
		<b>AF/AE-L Button</b>	Sets the function for when <b>AF/AE-L</b> is pressed.	Enable AF1
		<b>AF/AE-L Button (Movie)</b>	Sets the function for when <b>AF/AE-L</b> is pressed in  mode.	Enable AF1
		<b>Self-portrait Shutter Button</b>	Sets whether to use the self-portrait shutter button as the shutter release button when taking self-portraits.	On
	<b>Memory</b>	Determines which settings to save when the power is turned off.		On for settings other than Digital Filter, HDR Capture, Clarity Enhancement, and Shooting Info Display
<b>Save USER Mode</b>	You can save frequently used capture settings to <b>U1</b> or <b>U2</b> of the mode dial.		–	



\*1 The function appears only when the mode dial is set to **U1** or **U2**.

\*2 The function appears in modes other than **SCN** mode.

\*3 The function appears in **SCN** mode.

\*4 The function can also be set from the control panel.

## Movie Menu

Menu	Item	Function	Default Setting
 1	<b>Movie Capture Settings</b> *1	Sets the number of recorded pixels and the framerate of the movie.	 /30p
	<b>Recording Sound Level</b> *1	Sets the Recording Sound Level for recording.	Auto
	<b>Digital Filter</b> *1	Applies a digital filter effect when recording a movie.	No Filter
	<b>HDR Capture</b> *1	Sets the type of high dynamic range shooting.	Off
	<b>Clarity Enhancement</b> *1	Enhances the texture and surface details of the subject.	Off
<b>Movie SR</b> *1	Activates the Shake Reduction function.	On	





\*1 The function can also be set from the control panel.

## Playback Menu

Menu	Item	Function	Default Setting	
	<b>Slideshow</b>	<b>Display Duration</b>	Sets an image display interval.	3sec.
		<b>Screen Effect</b>	Sets a transition effect when the next image is displayed.	Off
		<b>Repeat Playback</b>	Starts the slideshow again from the beginning after the last image is displayed.	Off
		<b>Auto Movie Playback</b>	Plays back movies during the slideshow.	On
▶1	<b>Quick Zoom</b>	Sets the initial magnification when magnifying images.	Off	
	<b>Highlight Alert</b>	Sets overexposed areas to blink red in Standard Information Display or Histogram Display in playback mode.	Off	
	<b>Auto Image Rotation</b>	Rotates images which were captured with the camera held vertically or of which the rotation information has been changed.	On	
	<b>Protect All Images</b>	Protects all stored images at once.	–	
	<b>Delete All Images</b>	Deletes all stored images at once.	–	

## Set-up Menus

Menu	Item	Function	Default Setting	
1	<b>Language/言語</b>	Changes the display language.	English	
	<b>Date Adjustment</b>	Sets the date and time and the display format.	01/01/2015	
	<b>World Time</b>	Switches between the date and time display of your hometown city and that of a specified city.	Hometown	
	<b>Text Size</b>	Magnifies the text size when selecting a menu item.	Std.	
	<b>Sound Effects</b>	Switches the operation sound on/off and changes the volume for In-focus, AE-L, Self-timer, Remote Control, Change AF Point, One Push File Format, Shake Reduction, and Wi-Fi operations.	Volume 3/ All On	
	<b>LCD Display</b>	<b>Guide Display</b>	Displays the operation guides when the capture mode is changed.	On
		<b>Display Color</b>	Sets the display color of the status screen, control panel and menu cursor.	1
	<b>LCD Display Settings</b>		Adjusts the brightness, saturation and the color of the monitor.	0
2	<b>USB Connection</b>	Sets the USB connection mode when connecting to a computer.	MSC	
	<b>HDMI Out</b>	Sets the output format when connecting to an AV device with an HDMI input terminal.	Auto	
	<b>Folder Name</b>	Sets the folder name in which images are stored.	Date	
	<b>Create New Folder</b>	Creates a new folder on the memory card.	–	
	<b>File Name</b>	Sets the file name assigned to an image.	IMGP/_IMG	
	<b>File No.</b>	<b>Sequential Numbering</b>	Continues the sequential numbering for the file name when a new folder is created.	On
		<b>Reset File Number</b>	Resets the file number setting and returns to 0001 each time a new folder is created.	–
<b>Copyright Information</b>		Sets the photographer and copyright information embedded in the Exif data.	Off	

Menu	Item	Function	Default Setting	
3	<b>Flicker Reduction</b>	Cuts down on the screen flicker by setting the power frequency.	50Hz	
	<b>Auto Power Off</b>	Sets the time until the camera turns off automatically if no operations are made for a certain period of time.	1min.	
	<b>Indicator Lamps</b>	<b>Other Indicator Lamps</b>	Lights up the main switch lamp, self-portrait shutter button lamp, and <b>OK</b> lamp when the power is turned on.	High
		<b>Self-timer</b>	Lights up the remote control receiver lamp during the countdown for Self-timer shooting.	On
		<b>Remote Control</b>	Lights up the remote control receiver lamp during the standby and countdown for Remote Control shooting and after Remote Control shooting.	On
	<b>Wi-Fi</b>	Activates the built-in Wi-Fi function.	Off	
<b>Reset</b>	Resets the settings of the direct keys and for the items of the  menu,  menu,  menu,  menu, control panel, and playback mode palette.	–		
4	<b>Pixel Mapping</b>	Maps out and corrects any defective pixels on the sensor.	–	
	<b>Dust Removal</b>	Cleans the sensor by shaking it.	Off	
	<b>Sensor Cleaning</b>	Locks the mirror in the up position for cleaning the sensor with a blower.	–	
	<b>Format</b>	Formats a memory card.	–	
	<b>Firmware Info/Options</b>	Displays the camera's firmware version. You can check the current firmware version before running an update.	–	
	<b>Certification Marks</b>	Displays the certification marks of conformance to wireless technical standards.	–	

## Custom Setting Menus

Menu	Item	Function	Default Setting
C1	<b>1 EV Steps</b>	Sets the adjustment steps for exposure.	1/3 EV Steps
	<b>2 Sensitivity Steps</b>	Sets the adjustment steps for ISO sensitivity.	1 EV Step
	<b>3 Meter Operating Time</b>	Sets the meter operating time.	10sec.
	<b>4 AE-L with AF Locked</b>	Sets whether to lock the exposure value when the focus is locked.	Off
	<b>5 Link AE and AF Point</b>	Sets whether to link the exposure and AF point in the focusing area.	Off
	<b>6 Auto EV Compensation</b>	Automatically compensates the exposure when the correct exposure cannot be achieved with the current settings.	Off
	<b>7 Bulb (B) Mode Options</b>	Sets the camera operation when pressing <b>SHUTTER</b> in <b>B</b> mode.	Type1
C2	<b>8 Bracketing Order</b>	Sets the order for Bracketing shooting.	0 - +
	<b>9 One-Push Bracketing</b>	Shoots all frames with one release when using Bracketing.	Off
	<b>10 Interval Shooting Options</b>	Sets whether to start counting the time of interval from when exposure starts or when exposure ends for Interval Shooting, Interval Composite, and Interval Movie Record.	Interval
	<b>11 AF in Interval Shooting</b>	Sets whether to lock the focus position used when the first picture is taken or perform autofocus for each exposure for Interval Shooting and Interval Composite.	Locks focus at 1st exposure
	<b>12 WB Adjustable Range</b>	Sets whether to automatically fine-tune the white balance when the light source is specified for the white balance setting.	Fixed
	<b>13 WB When Using Flash</b>	Sets the white balance setting when using a flash.	Auto White Balance
	<b>14 AWB in Tungsten Light</b>	Sets the tungsten light color tone when the white balance is set to [Auto White Balance].	Strong Correction

Menu	Item	Function	Default Setting
C3	<b>15 Color Temperature Steps</b>	Sets the adjustment steps for the Color Temperature option of the white balance.	Kelvin
	<b>16 Superimpose AF Area</b>	Displays the active AF point in red in the viewfinder.	On
	<b>17 AF.S Setting</b>	Sets the action priority for when the autofocus mode is set to <b>AF.S</b> and <b>SHUTTER</b> is fully pressed.	Focus-priority
	<b>18 1st Frame Action in AF.C</b>	Sets the action priority for the first frame when the autofocus mode is set to <b>AF.C</b> and <b>SHUTTER</b> is fully pressed.	Release-priority
	<b>19 Action in AF.C Continuous</b>	Sets the action priority during Continuous Shooting when the autofocus mode is set to <b>AF.C</b> .	Focus-priority
	<b>20 Hold AF Status</b>	Maintains the focus for a certain amount of time when the subject happens to move out of the selected focusing area after being focused.	Off
	<b>21 AF with Remote Control</b>	Sets whether to use autofocus when shooting with a remote control unit.	Off
C4	<b>22 Release While Charging</b>	Sets whether to release the shutter while the built-in flash is being charged.	Off
	<b>23 Color Space</b>	Sets the color space to use.	sRGB
	<b>24 Save Rotation Info</b>	Saves rotation information when shooting.	On
	<b>25 Save Menu Location</b>	Saves the last menu tab displayed on the monitor and displays it again the next time <b>MENU</b> is pressed.	Reset Menu Location
	<b>26 Catch-in Focus</b>	Enables Catch-in Focus shooting when a manual focus lens is attached. The shutter is released automatically when the subject comes into focus.	Off
	<b>27 AF Fine Adjustment</b>	Allows you to precisely fine tune your lenses with the camera's autofocus system.	Off
	<b>28 Using Aperture Ring</b>	Enables the shutter to release when the lens aperture ring is set to a position other than <b>A</b> (Auto).	Disable
C5	<b>Reset Custom Functions</b>	Resets all the settings of the Custom Setting menus to the defaults.	–

## Getting Your Camera Ready for Use

### Attaching the Strap

- 1 Pass the end of the strap through the strap lug and secure it on the inside of the clasp.

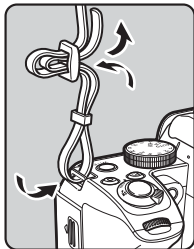

- 2 Attach the other end in the same manner.

### Attaching a Lens

- 1 Make sure that the camera is turned off.
- 2 Remove the body mount cover (1) and lens mount cover (2).

After removing the cover, be sure to put the lens down with the lens mount side facing upward.

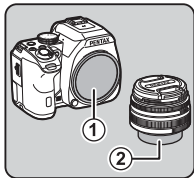

- 3 Align the lens mount indexes (red dots: 3) on the camera and the lens, and secure by turning the lens clockwise until it clicks.

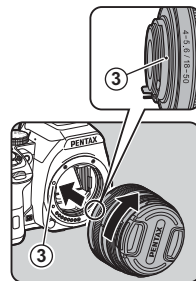

#### To remove the lens

Attach the lens cap, and then turn the lens counterclockwise while pressing the lens unlock button (4).

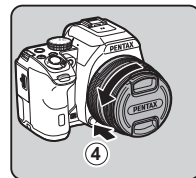

#### ⚠ Caution

- When a retractable lens is attached and is not extended, you cannot take pictures and use some functions. If the lens is retracted during shooting, the camera stops working. Refer to Step 2 of "Shooting with the Viewfinder" (p.26) for how to use the retractable lens.

## Charging the Battery

- 1 Connect the AC plug cord to the battery charger.
- 2 Plug the AC plug cord into the power outlet.

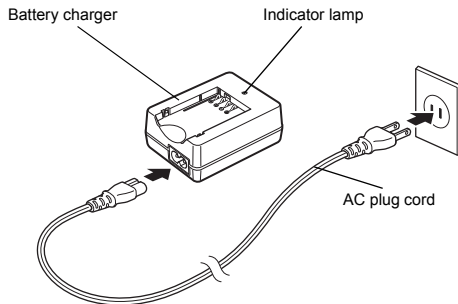

- 3 Face the ▲ mark on the battery up, and insert it into the battery charger.

Insert the battery into the battery charger at an angle, and then fit into place.

The indicator lamp is lit while charging and turns off when the battery is fully charged.

(Approximate maximum charging time: 240 minutes)

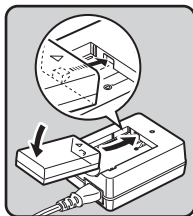

## Inserting/Removing the Battery

- 1 Open the battery cover. Slide the battery cover unlock lever (1) before opening the cover.

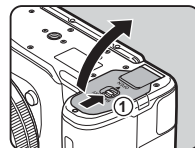

- 2 Face the ▲ mark on the battery towards the outside of the camera, and insert the battery until it locks into place.

To remove the battery, push the battery lock lever in the direction of ②.

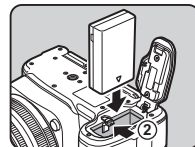

- 3 Close the battery cover.

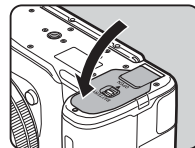



## Inserting/Removing a Memory Card

**1** Make sure that the camera is turned off.

**2** Slide the memory card cover in the direction of ① and then rotate it to open as shown by ②.

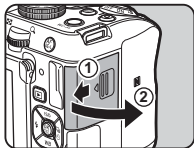

**3** Insert the card all the way into the memory card slot with the memory card label facing toward the side with the monitor.

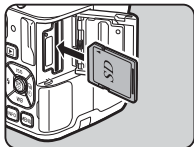

Push the memory card in once and release to remove.

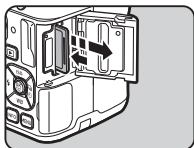

**4** Rotate the memory card cover as shown by ③, and slide it in the direction of ④.

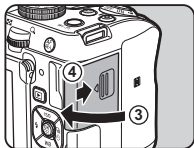

## Opening the Monitor

**1** Open the monitor 180° horizontally while holding the top and bottom of it.

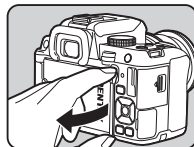

**2** Rotate the monitor 180° forward.

The monitor can also be rotated up to 90° backward.

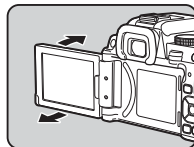

**3** Close the monitor on the camera so that the LCD screen can be seen.

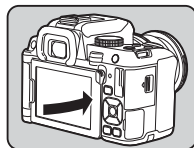

## ⚠ Caution

- To close the monitor with the LCD screen facing inward, rotate the monitor 180° backward in Step 2.
- When the monitor is closed with the LCD screen facing inward, you cannot play back images and display the menus.
- Do not hold the camera by the monitor or rotate the monitor beyond its movable range.
- Do not carry the camera or put it in a bag with the monitor open. You can carry the camera when the monitor is closed regardless of the LCD screen direction.

## Setting the Display Language and Date/Time

### 1 Turn the main switch to [ON].

The lamp lights up in green.  
The [Language/言語] screen appears.

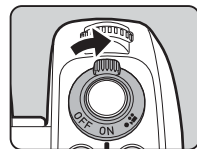

### 2 Use ▲▼◀▶ to select the desired language and press [OK].

The [Initial Setting] screen appears in the selected language.  
Proceed to Step 7 if  (Hometown) does not need to be changed.

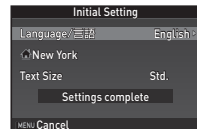

### 3 Press ▼ to move the frame to and press ▶.

The [ Hometown] screen appears.

### 4 Use ◀▶ to select a city. Use to change the region.

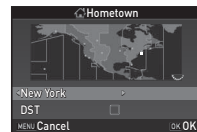

### 5 Press ▼ to select [DST] (daylight saving time), and use ◀▶ to select or .

## 6 Press **OK**.

The camera returns to the [Initial Setting] screen.

## 7 Press **▼** to select [Text Size] and press **▶**.

## 8 Use **▲▼** to select [Std.] or [Large], and press **OK**.

Selecting [Large] increases the text size of the selected menu items.

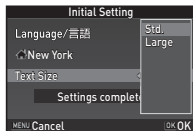

## 9 Press **▼** to select [Settings complete] and press **OK**.

The [Date Adjustment] screen appears.

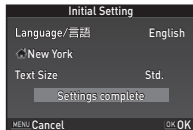

## 10 Press **▶**, and use **▲▼** to select the date format.

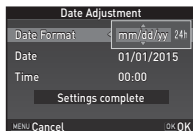

## 11 Press **▶**, and use **▲▼** to select [24h] or [12h].

## 12 Press **OK**.

The frame returns to [Date Format].

## 13 Press **▼**, and then press **▶**.

The frame moves to the month if the date format is set to [mm/dd/yy].

## 14 Use **▲▼** to set the month.

Set the day, year and time in the same manner.

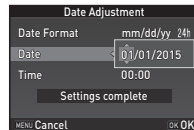

## 15 Press **▼** to select [Settings complete] and press **OK**.

The [LCD Display] screen appears.

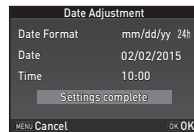

## 16 Use **◀▶** to select a color.

Select the display color of the status screen, control panel and menu cursor from colors 1 to 12.

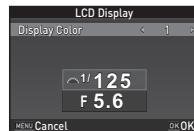

## 17 Press **OK**.

The camera switches to capture mode and is ready to take a picture.

## Formatting a Memory Card



- 1 Press **MENU**.**  
The 1 menu appears.
- 2 Use or to display 4 menu.**
- 3 Use to select [Format] and press .**  
The [Format] screen appears.
- 4 Press to select [Format] and press **OK**.**

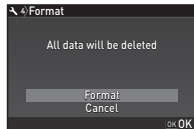

- 5 Press **MENU**.**  
The camera switches to capture mode and is ready to take a picture.

## Basic Shooting Operation

### Shooting with the Viewfinder

- 1 Remove the front lens cap by pushing the top and bottom portions as indicated in the illustration.**

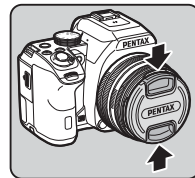

- 2 When a retractable lens is attached, turn the zoom ring in the direction of **2** while pressing the button on the ring **1**.**

When retracting the lens, turn the zoom ring in the opposite direction to **2** while pressing the button on the ring and align the white dot to the position **3**.

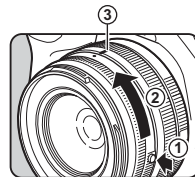

- 3** Set the focus mode switch to **AF**.

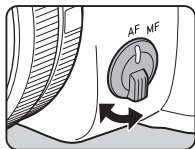

- 4** Turn the mode dial and align the dial indicator to **AUTO**.

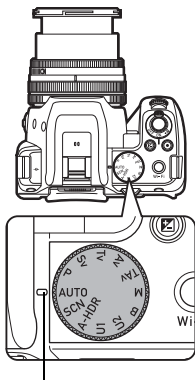

Dial indicator

The selected capture mode is displayed on the monitor (Guide Display).

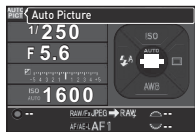

- 5** Look through the viewfinder to view the subject.

When using a zoom lens, turn the zoom ring to the right or left to change the angle of view.

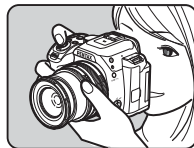

- 6** Position the subject inside the AF frame and press **SHUTTER** halfway.



Focus indicator

- 7** Press **SHUTTER** fully.

The captured image is displayed on the monitor (Instant Review).

#### Available operations during Instant Review



Deletes the image.



Magnifies the image.





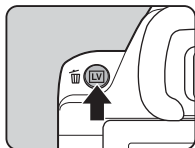

Saves the RAW data (only when a JPEG image was taken and the data remains in the buffer).

## Shooting While Viewing the Live View Image

- 1 Press **LV** in Step 5 of “Shooting with the Viewfinder” (p.26). The Live View image is displayed on the monitor.



### Available operations

- OK** Magnifies the image.  
Use  to change the magnification (up to 10×).  
Use   to change the area to display.  
Press  to return the display area to the center.  
Press **OK** to return to 1× image display.

- LV** Exits shooting with Live View.

- 2 Position the subject inside the AF frame on the monitor and press **SHUTTER** halfway.



AF frame

Subsequent steps are the same as shooting with the viewfinder.

## Taking a Self-portrait

You can take self-portraits while checking the Live View image by facing the lens and the LCD screen of the monitor toward yourself.

- 1 In Step 2 of “Shooting While Viewing the Live View Image” (p.28), open the monitor 180° horizontally.

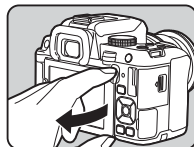

- 2 Face both the lens and the LCD screen of the monitor toward yourself.

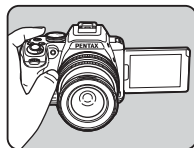

- 3 Check the Live View image and press the self-portrait shutter button.

After the picture is taken, Instant Review is displayed until the next operation.

The camera returns to standby mode when the self-portrait shutter button is pressed again.

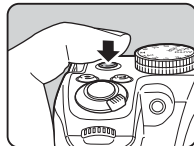









### ⚠ Caution

- The self-portrait shutter button does not work with a halfway press and needs to be fully pressed down. If the button is pressed when the focus mode is set to **AF**, a picture is taken after autofocus is performed. Even if the subject is not in focus, the shutter release has priority over focusing the subject and a picture is taken.
- When the self-portrait shutter button can be used for shooting, other button/dial operations are disabled.
- Keep the monitor closed when not using the camera.

### 📌 Memo

- Shooting with the self-portrait shutter button is available only when [Self-portrait Shutter Button] of [Button Customization] in the **Q4** menu is set to [On] (default setting) and the monitor is positioned at the correct angle. (p.15) When the self-portrait shutter button can be used for shooting, the indicator lamp lights green or red and the main switch lamp turns off. At all other times, the self-portrait shutter button functions as the switch to turn the Wi-Fi function on or off. (p.39)

## Capture Modes for Still Pictures

Capture Mode	Application	Page
<b>AUTO</b> (Auto Picture modes)	Automatically selects the optimal capture mode from  (Standard),  (Landscape),  (Macro),  (Moving Object),  (Night Scene Portrait),  (Sunset),  (Blue Sky) or  (Forest).	p.27
<b>SCN</b> (Scene modes)	Offers you various scene modes to choose from.	p.30
<b>A-HDR</b> (Advanced HDR mode)	Takes three consecutive images using the Clarity Enhancement feature to create a single composite image with them.	p.31
<b>P/Sv/Tv/Av/ Tv/M/B</b> (Exposure modes)	Allows you to change the shutter speed, aperture value, and sensitivity.	p.31

### ⚠ Caution

- The functions that can be set vary depending on the capture mode. Refer to “Restrictions on Each Capture Mode” (p.40) for details.

### 📌 Memo

- You can save frequently used capture modes and settings to **U1** and **U2** so that you can repeatedly use the same modes and settings.

## Scene Modes

### 1 Set the mode dial to SCN.

The scene mode selection screen appears.

### 2 Select a scene mode.



<b>Portrait</b>	For capturing portraits. Reproduces a healthy and bright skin tone.
<b>Landscape</b>	For capturing landscape views. Reproduces the vivid green of trees.
<b>Macro</b>	For capturing tiny objects at close focus range like flowers, coins, jewelry, and more.
<b>Moving Object</b>	For capturing images of fast moving subjects.
<b>Night Scene Portrait</b>	For capturing images of people in low light conditions, such as dusk or at night.
<b>Sunset</b>	For capturing sunrises or sunsets in beautiful, vivid color.
<b>Blue Sky</b>	For capturing images of blue sky. Produces a more impressive deep blue.
<b>Forest</b>	Enhances colors of trees and sunbeams through foliage and produces a vivid color image.

<b>Night Scene</b>	Used for shooting at night.
<b>Night Scene HDR</b>	Takes three consecutive images at three different exposure levels (-1, ±0, +1) to create a single composite image from them.
<b>Night Snap</b>	For taking snapshots in poorly lit places.
<b>Food</b>	For capturing images of food. Saturation will be rather high to make food look appetizing.
<b>Pet</b>	For capturing moving pets.
<b>Kids</b>	For capturing moving kids. Reproduces healthy and bright skin tone.
<b>Surf &amp; Snow</b>	For capturing images of dazzling backgrounds, such as snowy mountains.
<b>Backlight Silhouette</b>	Produces a silhouette image of the subject in backlight conditions.
<b>Candlelight</b>	For capturing scenes in candlelight.
<b>Stage Lighting</b>	For capturing moving subjects in poorly lit places.
<b>Museum</b>	For capturing images in places where a flash is prohibited.

### 3 Press **OK**.

The camera is in standby mode.

Turn to change the scene mode.



## Advanced HDR Mode

**1** Set the mode dial to **A-HDR**.

**2** Turn  to set the range in which to change the exposure.

Select from  $\pm 1$ ,  $\pm 2$ , or  $\pm 3$ .



## Exposure Modes

✓: Available #: Restricted ✗: Not available



Mode	Change Shutter Speed	Change Aperture Value	Change Sensitivity	EV Compensation
<b>P</b> Program Automatic Exposure	# *1	# *1	✓	✓
<b>Sv</b> Sensitivity Priority Automatic Exposure	✗	✗	✓ *2	✓
<b>Tv</b> Shutter Priority Automatic Exposure	✓	✗	✓	✓
<b>Av</b> Aperture Priority Automatic Exposure	✗	✓	✓	✓
<b>TAv</b> Shutter & Aperture Priority Automatic Exposure	✓	✓	✓ *3	✓
<b>M</b> Manual Exposure	✓	✓	✓ *2	✓
<b>B</b> Bulb Exposure	✗	✓	✓ *2	✗

\*1 You can set the value to be changed in [E-Dial Programming] of the 4 menu.

\*2 [ISO AUTO] is not available.

\*3 Fixed to [ISO AUTO].

## 1 Set the mode dial to the desired exposure mode.

 or  appears on the status screen for the value that can be changed.

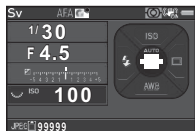

The value that can be changed is underlined in the viewfinder.



During Live View,  appears for the value that can be changed.



## 2 Turn .

The aperture value is changed in **Av**, **TAv**, **M**, or **B** mode.  
The sensitivity is changed in **Sv** mode.

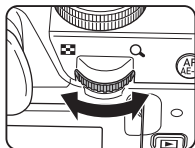

## 3 Turn .

The shutter speed is changed in **Tv**, **TAv**, or **M** mode.

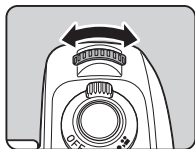

## Setting the Sensitivity

### 1 Press in standby mode.

### 2 Use to select an item.

<b>ISO AUTO</b>	Sets the range to be adjusted automatically. Both the upper limit and lower limit can be changed.
<b>ISO</b>	Sets a fixed value from ISO 100 to ISO 51200.

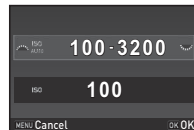

### 3 Use or to change the value.

### 4 Press .

The camera returns to standby mode.

## Compensating the Exposure

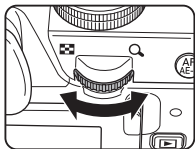
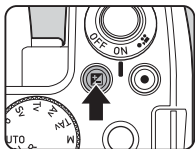

- 1 Press , and then turn .

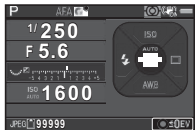

 and the compensation value are displayed on the status screen, Live View screen, and in the viewfinder during adjustment.



### Available operations

-  Starts/ends adjusting the compensation value.
-  Resets the adjustment value to the default setting.

## Recording Movies

- 1 Turn the main switch to .

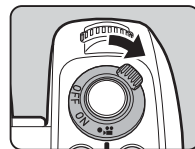

The indicator lamp lights red and the Live View image is displayed.



Recordable Time

- 2 Set the mode dial to the desired capture mode.

The following settings are available depending on the capture mode.

<b>Av/TAv/M</b>	The camera operates in the selected exposure mode. (The aperture value can be changed only before shooting. When set to <b>M</b> mode, the sensitivity can also be changed.)
<b>U1/U2</b>	The camera operates according to the saved exposure mode.
<b>Other modes</b>	The camera operates in <b>P</b> mode.

- 3 Focus on the subject.

In **AF** mode, press **SHUTTER** halfway.

- 4** Press **SHUTTER** fully.  
Movie recording starts.  
In the upper left area of the monitor, "REC" blinks.
- 5** Press **SHUTTER** fully again.  
Movie recording stops.
- 6** Return the main switch to the [ON] position to exit **mode**.  
The camera returns to shooting with the viewfinder in **mode**.

## Setting the Flash Mode

- 1** Press **◀** in standby mode.
- 2** Select a flash mode.



	<b>Auto Flash Discharge</b>	Automatically measures the ambient light and determines whether to use the flash.
	<b>Auto Flash + Red-eye Reduction</b>	Discharges a pre-flash for red-eye reduction before an automatic flash.
	<b>Flash On</b>	Discharges a flash for each picture.
	<b>Flash On + Red-eye Reduction</b>	Discharges a pre-flash for red-eye reduction before the main flash and discharges a flash for each picture.
	<b>Slow-speed Sync</b>	Sets to a slow shutter speed and discharges a flash for each picture. Use this, for example, when shooting a portrait with the sunset in the background.
	<b>Slow-speed Sync+Red-eye</b>	Discharges a pre-flash for red-eye reduction before the main flash is discharged with Slow-speed Sync.
	<b>Trailing Curtain Sync</b>	Discharges a flash immediately before closing the shutter. Sets to a slow shutter speed. Captures moving objects as if they are leaving a light trail behind them.
	<b>Manual Flash Discharge</b>	Sets the amount of flash discharge between FULL and 1/128 power.

## Available operations



Compensates the flash exposure.  
Selects the amount of flash discharge (when [Manual Flash Discharge] is selected).



Resets the compensation value to the default setting.

### 3 Press **OK**.

The camera returns to standby mode.

### 4 Press **⏏**.

The built-in flash is popped up.

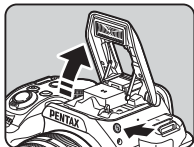

### **Memo**

- The flash modes that can be selected vary depending on the capture mode.

## Setting the Drive Mode

1 Press **▶** in standby mode.

2 Select a drive mode.

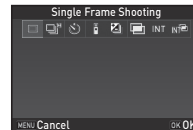

<b>Single Frame Shooting</b> (□)	Normal capture mode
<b>Continuous Shooting</b> (□/□)	Continuously takes pictures while <b>SHUTTER</b> is kept pressed.
<b>Self-timer</b> (☺/☺/☺)	Releases the shutter about 12 seconds or 2 seconds after <b>SHUTTER</b> is pressed.
<b>Remote Control</b> (Ⓜ/Ⓜ/Ⓜ)	Enables shooting with remote control.
<b>Bracketing</b> (Ⓜ/Ⓜ/Ⓜ)	Takes three consecutive pictures at different exposure levels.
<b>Multi-exposure</b> (Ⓜ/Ⓜ/Ⓜ/Ⓜ)	Creates a composite image by taking multiple pictures and merging them into a single image.
<b>Interval Shooting</b> (INT/INT/INT)	Automatically takes pictures at a set interval from a set time.
<b>Interval Composite</b> (INT/INT/INT)	Takes pictures at a set interval from a set time and merges them into a single image.

<b>Interval Movie Record</b> (INT/INT)/INT	Takes pictures at a set interval from a set time and saves them as a single movie file.
<b>Star Stream</b> (S/S/S)	Takes pictures at a set interval from a set time and saves them as a single movie file using the Bright composite mode of Interval Composite.

**3** Press **INFO** to change detailed settings, and press **OK**.

**4** Press **OK**.

The camera returns to standby mode.

#### **Caution**

- There are restrictions on some drive modes when used in some capture modes or in combination with some other functions. (p.40)

#### **Memo**

- In **Mode**, Remote Control (only), Interval Movie Record, and Star Stream can be selected.

## Setting the White Balance

- 1** Press **▼** in standby mode.
- 2** Select the desired white balance setting.

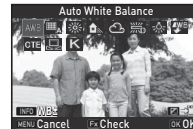

<b>AWB</b>	Auto White Balance
<b>A</b>	Multi Auto White Balance
<b>☀</b>	Daylight
<b>🏠</b>	Shade
<b>☁</b>	Cloudy
<b>☀</b>	Fluorescent - Daylight Color
<b>☀</b>	Fluorescent - Daylight White
<b>☀</b>	Fluorescent - Cool White
<b>☀</b>	Fluorescent - Warm White
<b>☀</b>	Tungsten
<b>WB</b>	Flash
<b>CTE</b>	Color Temperature Enhancement
<b>MWB</b>	Manual White Balance
<b>K</b>	Color Temperature

**3** Press **OK**.

The camera returns to standby mode.

## Reviewing Images





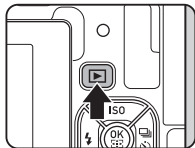





### 1 Press .

The camera enters playback mode and the most recently captured image is displayed (single image display).



### 2 Review the captured image.

#### Available operations

 to the left	Displays the previous image.
 to the right	Displays the next image.
	Deletes the image.
 to the right	Magnifies the image (up to 16×). Use     to change the area to display. Press  to return the display area to the center. Press <b>OK</b> to return to the entire image display.
 to the left	Switches to the thumbnail display.
	Saves the RAW data (only when a JPEG image was taken and the data remains in the buffer).
<b>INFO</b>	Changes the type of information displayed (p.8).











Displays the playback mode palette (p.38).

## Playing Back Movies

### 1 Display the movie to play back in single image display of the playback mode.



#### Available operations











	Plays back/pauses a movie.
	Forwards a frame (when paused).
Press and hold 	Fast-forwards playback.
	Reverses a frame (when paused).
Press and hold 	Fast-reverses playback.
	Stops playback.
	Adjusts the volume (21 levels).
	Saves the displayed frame as a JPEG file (when paused).
<b>INFO</b>	Switches between [Standard Information Display] and [No Information Display].

## Playback Mode Palette

Playback functions can be set from the playback mode palette as well as the  1 menu (p.16).

Press  in single image display of the playback mode to display the playback mode palette.



Item	Function
 <b>Image Rotation</b> *1	Changes the rotation information of images.
 <b>Digital Filter</b> *1	Processes images with digital filters.
 <b>Color Moiré Correction</b> *1 *2	Reduces color moiré in images.
 <b>Resize</b> *1 *2	Changes the number of recorded pixels of the image.
 <b>Cropping</b> *1	Crops out only the desired area of an image.
 <b>Protect</b>	Protects images from being accidentally erased.
 <b>Slideshow</b>	Plays back images one after another.
 <b>Save as Manual WB</b> *1	Saves the white balance settings of the captured image as Manual White Balance.
 <b>Save Cross Processing</b>	Saves the settings used for an image captured in Cross Processing mode of Custom Image as your "Favorite" settings.
 <b>RAW Development</b> *3	Develops RAW images into JPEG images and saves them as new files.
 <b>Movie Edit</b> *4	Divides a movie or deletes unwanted segments.

- \*1 Not available when a movie is displayed.
- \*2 Not available when a RAW image is displayed.
- \*3 Available only when a RAW image is saved.
- \*4 Available only when a movie is displayed.

## Sharing Images



### Enabling the Wi-Fi Function

This camera has a built-in Wi-Fi function. By directly connecting to a communication device such as a smartphone or tablet via wireless LAN, the camera can be operated from the communication device and images can be shared with others via social networks or e-mail.

The Wi-Fi function is disabled at the time of turning the camera on. Enable the function using one of the following methods.

#### Setting from the Menu



- 1 Select **[Wi-Fi]** in  3 menu and press  .  
The [Wi-Fi] screen appears.

- 2 Set **[Action Mode]** to **[ON]**.

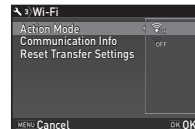

- 3 Press **MENU** twice.



## Pressing the Self-portrait Shutter Button

- 1 Press and hold the self-portrait shutter button.**  
A beep sounds and [Wi-Fi enabled] appears on the screen.

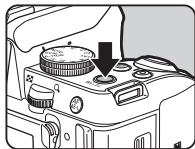

- 2 Release the self-portrait shutter button.**  
To disable the Wi-Fi function, press and hold the self-portrait shutter button again.

### **⚠ Caution**

- When the self-portrait shutter button lamp is lit green or red, it functions as the shutter release button. In such cases, use another method to turn the Wi-Fi function on or off.

## Touching a Communication Device

When this camera comes into contact with a communication device equipped with the NFC function, the camera establishes a Wi-Fi connection.

- 1 Lightly touch the communication device to the NFC mark of the camera.**  
A beep sounds and [Wi-Fi enabled] appears on the screen.

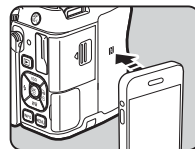

### **⚠ Caution**

- To establish a Wi-Fi connection by touching a communication device, the Wi-Fi function and the NFC reader/writer function of the device must be enabled in advance. For details on how to operate the communication device, refer to the operating manual of the device.









### **📄 Memo**

- When the dedicated application “Image Sync” is installed on the communication device, the camera can be operated with the communication device. Refer to the Operating Manual (PDF) for details. (p.63)

# Restrictions on Each Capture Mode

#: Restricted X: Not available

Capture Mode		SCN									A-HDR	B	
		AUTO											
Function													
Sensitivity							X	X		X		*1	# <sup>2</sup>
Flash						X	X			X	X		X
Drive Mode	Continuous Shooting						X				X	X	X
	Self-timer			X						X			X
	Remote Control			X						X			
	Bracketing			X			X		X	X	X	X	X
	Multi-exposure			X			X		X	X	X		X
	Interval Shooting			X						X		X	X
	Interval Composite			X			X		X	X	X	X	X
	Interval Movie Record	X	X	X	X	X	X	X	X	X	X	X	X
Star Stream	X	X	X	X	X	X	X	X	X	X	X	X	
Focus Method	A.F.A. 	A.F.S. 	A.F.S. <sup>*3</sup>	A.F.C. <sup>*3</sup>	A.F.S. 	A.F.S. <sup>*3</sup>	A.F.S. <sup>*3</sup>	A.F.C. <sup>*3</sup>	A.F.C. 	A.F.C. <sup>*3</sup>			
File Format RAW/RAW+							X				X		X

Function	Capture Mode	SCN									A-HDR	B	
		AUTO											
Shake Reduction							On <sup>*3</sup>					×	
White Balance	AWB <sup>*3</sup>	AWB <sup>*3</sup>	AWB <sup>*3</sup>	AWB <sup>*3</sup>	AWB <sup>*3</sup>	AWB <sup>*3</sup>	AWB <sup>*3</sup>	AWB <sup>*3</sup>	AWB <sup>*3</sup>	AWB <sup>*3</sup>			
Custom Image	× <sup>*5</sup>	× <sup>*5</sup>	× <sup>*5</sup>	× <sup>*5</sup>	× <sup>*5</sup>	× <sup>*5</sup>	× <sup>*5</sup>	× <sup>*5</sup>	× <sup>*5</sup>	× <sup>*5</sup>			
Digital Filter							×				×		
HDR Capture				×			× <sup>*6</sup>		×		× <sup>*6</sup>	×	# <sup>*7</sup>
AA Filter Simulator				# <sup>*8</sup>			×		# <sup>*8</sup>		×	# <sup>*8</sup>	×
Save RAW Data				×					×				×

\*1 [ISO AUTO] is not available.

\*2 Can be set from ISO 100 to ISO 3200 only when the capture mode is set to .

\*3 Fixed to; the setting cannot be changed.

\*4 Limited to; available settings are limited.

\*5 Fixed to a specific setting; the setting cannot be changed.

\*6 Specific settings are used.

\*7 Available only when the drive mode is set to [Interval Movie Record].

\*8 [Bracketing] is not available.

## Restrictions on the Combinations of Special Functions

#: Restricted x: Not available

		Digital Filter	HDR Capture	Clarity Enhancement	Lens Correction	AA Filter Simulator
<b>Flash</b>			x			
<b>Drive Mode</b>	<b>Continuous Shooting</b>		x			# <sup>*2</sup>
	<b>Bracketing</b>		x			# <sup>*2</sup>
	<b>Multi-exposure</b>	x	x	x	x	# <sup>*2</sup>
	<b>Interval Shooting</b>	# <sup>*1</sup>	# <sup>*1</sup>	# <sup>*1</sup>		# <sup>*2</sup>
	<b>Interval Composite</b>	x	x	x	x	# <sup>*2</sup>
	<b>Interval Movie Record</b>	# <sup>*1</sup>	# <sup>*1</sup>	# <sup>*1</sup>	x	x
	<b>Star Stream</b>	x	x	x	x	x
<b>File Format RAW/RAW+</b>			x			
<b>Digital Filter</b>			x	x		
<b>HDR Capture</b>		x				x

\*1 There is a restriction on the minimum value for [Interval].

\*2 [Bracketing] is not available.

## Functions Available with Various Lenses

All capture modes are available when a DA, DA L, or FA J lens is used, or when a lens with an **A** position is used with the aperture ring set to the **A** position.

When other lenses than above are used, or a lens with **A** position is used in a position other than **A**, the following restrictions apply.

✓: Available #: Restricted ✗: Not available

Function	Lens [Mount type]	DA DA L D FA	FA J FA *6	F *6	A	M P
		[KAF] [KAF2] [KAF3]	[KAF] [KAF2]	[KAF]	[KA]	[K]
Autofocus (Lens only) (With AF adapter 1.7x) *1		✓ -	✓ -	✓ -	- #	- #
Manual focus (With focus indicator) *2 (With matte field)		✓	✓	✓	✓	✓
Quick-shift focus		#*4	✗	✗	✗	✗
Focus point selection mode [Auto]		✓	✓	✓	#*8	✗
AE Metering [Multi-segment]		✓	✓	✓	✓	✗
<b>P/Sv/Tv/Av/TA</b> v mode		✓	✓	✓	✓	#*9
<b>M</b> mode		✓	✓	✓	✓	#
P-TTL auto flash *3		✓	✓	✓	✓	✗
Automatic obtaining of the lens focal length information		✓	✓	✓	✗	✗
Lens Correction		✓*5	✗*7	✗	✗	✗

- \*1 Lenses with a maximum aperture of F2.8 or faster. Only available at the **A** position.
- \*2 Lenses with a maximum aperture of F5.6 or faster.
- \*3 Available when using the built-in flash, AF540FGZ, AF540FGZ II, AF360FGZ, AF360FGZ II, AF200FG, or AF160FC.
- \*4 Only available with compatible lenses.
- \*5 Distortion Correction and Peripheral Illumination Correction are disabled when a DA FISH-EYE 10-17mm lens is used.
- \*6 To use an FA SOFT 28mm F2.8 lens, FA SOFT 85mm F2.8 lens, or F SOFT 85mm F2.8 lens, set [28 Using Aperture Ring] to [Enable] in the **C4** menu. Pictures can be taken with the aperture you set, but only within a manual aperture range.
- \*7 Only available with an FA 31mm F1.8 Limited, FA 43mm F1.9 Limited, or FA 77mm F1.8 Limited lens.
- \*8 Fixed to [Spot].
- \*9 **Av** with the aperture set to wide open. (The aperture ring has no effect on the actual aperture value.)

# Main Specifications

## Model Description

Type	TTL autofocus, auto-exposure SLR digital camera with a built-in retractable P-TTL flash
Lens Mount	PENTAX KAF2 bayonet mount (AF coupler, lens information contacts, K-mount with power contacts)
Compatible Lenses	KAF3, KAF2 (power zoom not compatible), KAF, KA mount lenses

## Image Capture Unit

Image Sensor	Primary color filter, CMOS, Size: 23.5 × 15.6 (mm)
Effective Pixels	Approx. 20.12 megapixels
Total Pixels	Approx. 20.42 megapixels
Dust Removal	SP coating and CMOS sensor vibration
Sensitivity	ISO AUTO/100 to 51200 (EV steps can be set to 1 EV, 1/2 EV, or 1/3 EV)
Image Stabilizer	Sensor-shift Shake Reduction
AA Filter Simulator	Moiré reduction using SR unit: OFF/Type1/Type2/Bracketing

## File Formats

Recording Formats	RAW (PEF/DNG), JPEG (Exif 2.30), DCF 2.0 compliant
Recorded Pixels	JPEG: [L] (20M: 5472×3648), [M] (12M: 4224×2816), [S] (6M: 3072×2048), [XS] (2M: 1920×1280) RAW: [L] (20M: 5472×3648)
Quality Level	RAW (12bit): PEF, DNG JPEG: ★★★ (Best), ★★ (Better), ★ (Good) RAW + JPEG simultaneously recordable
Color Space	sRGB, AdobeRGB
Storage Media	SD/SDHC*/SDXC* memory card (*UHS-I compatible)

Storage Folder	Folder Name: Date (100_1018, 101_1019...) or a user-assigned name (default: PENTX)
Storage File	File Name: user-assigned name (default: IMG*****) File No.: Sequential Numbering, Reset

## Viewfinder

Type	Pentaprism Finder
Coverage (FOV)	Approx. 100%
Magnification	Approx. 0.95× (50mm F1.4 at infinity)
Eye-Relief Length	Approx. 20.5 mm (from the view window), Approx. 22.3 mm (from the center of lens)
Diopter Adjustment	Approx. -2.5 to +1.5 m <sup>-1</sup>
Focusing Screen	Interchangeable Natural-Bright-Matte III focusing screen

## Live View

Type	TTL method using the CMOS image sensor
Focusing System	Contrast detection (Face Detection, Tracking, Multiple AF Points, Select, Spot) Focus Peaking: ON/OFF
Display	Field of view: approx. 100%, Electronic Level Display, Magnified view (up to 10×), Grid Display (4 × 4 Grid, Golden Section, Scale), Histogram, Highlight Alert

## LCD Monitor

Type	Vari-angle TFT color LCD monitor featuring an air-gapless structure with a tempered-glass front panel
Size	3.0 inches (3:2)
Dots	Approx. 921K dots
Adjustment	Brightness, saturation and colors adjustable

## White Balance

Type	Method using a combination of the CMOS image sensor and the light source detection sensor
Preset Modes	Auto White Balance, Multi Auto White Balance, Daylight, Shade, Cloudy, Fluorescent Light ( <b>D</b> : Daylight Color, <b>N</b> : Daylight White, <b>W</b> : Cool White, <b>L</b> : Warm White), Tungsten Light, Flash, <b>CTE</b> , Manual White Balance, Color Temperature, Copying the white balance settings of a captured image
Fine Adjustment	Adjustable $\pm 7$ steps on A-B axis and G-M axis

## Autofocus System

Type	TTL: phase-matching autofocus
Focus Sensor	SAFOX X, 11 points (9 cross type focus points in the center)
Brightness Range	EV -3 to 18 (ISO100, at normal temperature)
AF Modes	Single AF ( <b>A.F.S.</b> ), Continuous AF ( <b>A.F.C.</b> ), Auto select AF ( <b>A.F.A.</b> )
Focus Point Selection Modes	Auto (11 AF Points), Auto (5 AF Points), Select, Expanded Area AF, Spot
AF Assist Light	Dedicated LED AF assist light

## Exposure Control

Type	TTL open-aperture 77 segment metering Metering modes: Multi-segment, Center-weighted, Spot
Metering Range	EV 0 to 22 (ISO100 at 50mm F1.4)
Capture Modes	Auto Picture modes: Standard, Portrait, Landscape, Macro, Moving Object, Night Scene Portrait, Sunset, Blue Sky, Forest Scene Modes: Portrait, Landscape, Macro, Moving Object, Night Scene Portrait, Sunset, Blue Sky, Forest, Night Scene, Night Scene HDR (JPEG only), Night Snap, Food, Pet, Kids, Surf & Snow, Backlight Silhouette, Candlelight, Stage Lighting, Museum Advanced HDR mode (JPEG only): exposure bracket value is selectable from $\pm 1$ , $\pm 2$ or $\pm 3$ EV Exposure modes: Program, Sensitivity Priority, Shutter Priority, Aperture Priority, Shutter & Aperture Priority, Manual, Bulb

EV Compensation	$\pm 5$ EV (1/3 EV steps or 1/2 EV steps can be selected)
AE Lock	Can be assigned to <b>AF/AE-L</b> from [Button Customization].

## Shutter

Type	Electronically controlled vertical-run focal plane shutter
Shutter Speed	Auto: 1/6000 to 30 seconds, Manual: 1/6000 to 30 seconds (1/3 EV steps or 1/2 EV steps), Bulb

## Drive Modes

Mode Selection	[Still picture] Single frame, Continuous (H, L), Self-timer (12 sec., 2 sec., continuous), Remote Control (immediately, 3 sec., continuous), Bracketing <sup>*1</sup> , Multi-exposure <sup>*2</sup> , Interval Shooting <sup>*1</sup> , Interval Composite <sup>*1</sup> [Movie] Remote Control, Interval Movie Record <sup>*1</sup> , Star Stream <sup>*1</sup> <sup>*1</sup> Available with Self-timer or Remote Control <sup>*2</sup> Available with Continuous Shooting, Self-timer, or Remote Control
Continuous Shooting	Max. approx. 5.5 fps, JPEG ([L]: <b>★★★</b> at Continuous H): 30 frames, RAW: 9 frames, RAW+: 6 frames Max. approx. 3.0 fps, JPEG ([L]: <b>★★★</b> at Continuous L): 100 frames, RAW: 14 frames, RAW+: 8 frames • When the sensitivity is set to ISO100.
Multi-exposure	Composite Mode: Additive, Average, Bright Number of Shots: 2 to 2000 times

Interval Shooting	[Interval Shooting] Interval: 2 sec. to 24 hr., Standby Interval: minimum time or 1 sec. to 24 hr., Number of Shots: 2 to 2000 times, Start Interval: Now, Set Time [Interval Composite] Interval: 2 sec. to 24hr., Standby Interval: minimum time or 1 sec. to 24 hr., Number of Shots: 2 to 2000 times, Start Interval: Now, Set Time, Composite Mode: Additive, Average, Bright, Save Process: On, Off [Interval Movie] Recorded Pixels: [4K], [FullHD], [HD], Interval: 2 sec. to 24 hr., Standby Interval: minimum time or 1 sec. to 24 hr., Number of Shots: 8 to 2000 times ([4K]: 8 to 500 times), Start Interval: Now, Set Time [Star Stream] Recorded Pixels: [4K], [FullHD], [HD], Standby Interval: minimum time or 1 sec. to 24 hr., Number of Shots: 8 to 2000 times ([4K]: 8 to 500 times), Start Interval: Now, Set Time, Fade-out: Off, Low, Medium, High
-------------------	---

#### Flash

Built-in Flash	Built-in retractable P-TTL pop-up flash Guide number: approx. 12 (ISO100/m) Angle of view coverage: equivalent to 28mm lens in 35 mm format
Flash Modes	Auto Flash Discharge (Auto Picture, Scene Mode), Auto Flash + Red-eye Reduction (Auto Picture, Scene Mode), Flash On, Flash On + Red-eye Reduction, Slow-speed Sync, Slow-speed Sync + Red-eye, Trailing Curtain Sync, Manual Flash Discharge (FULL to 1/128 power)
Sync Speed	1/180 sec.
Flash Exposure Compensation	-2.0 to +1.0 EV
External Flash	P-TTL, Leading Curtain Sync, Trailing Curtain Sync, Contrast-control-sync, High-speed Sync, Wireless Sync • Available with 2 dedicated external flashes

#### Capture Functions

Custom Image	Bright, Natural, Portrait, Landscape, Vibrant, Radiant, Muted, Bleach Bypass, Reversal Film, Monochrome, Cross Processing
Cross Processing	Random, Preset 1-3, Favorite 1-3
Digital Filter	Extract Color, Replace Color, Toy Camera, Retro, High Contrast, Shading, Invert Color, Unicolor Bold, Bold Monochrome
HDR Capture	Auto, Type1, Type2, Type3 Bracket Value adjustable Auto Align: On, Off
Clarity Enhancement	On, Off
Lens Correction	Distortion Correction, Peripheral Illumination Correction, Lateral Chromatic Aberration Correction, Diffraction Correction
D-Range Settings	Highlight Correction, Shadow Correction
Noise Reduction	Slow Shutter Speed NR, High-ISO NR
Electronic Level	Displayed in viewfinder (horizontal direction only); displayed on LCD monitor (horizontal direction and vertical direction)
Horizon Correction	SR On: corrects up to 1 degree, SR Off: corrects up to 1.5 degrees

#### Movie

File Format	MPEG-4 AVC/H.264 (MOV) • Motion JPEG (AVI) for Interval Movie Record and Star Stream
Recorded Pixels Framerate	[FullHD] (1920×1080, 30p/25p/24p) [HD] (1280×720, 60p/50p)
Sound	Built-in stereo microphone, external microphone (stereo recording compatible) Recording Sound Level adjustable (sound level is displayed on the monitor)
Recording Time	Up to 4 GB or 25 minutes; automatically stops recording if the internal temperature of the camera becomes high.



Custom Image	Bright, Natural, Portrait, Landscape, Vibrant, Radiant, Muted, Bleach Bypass, Reversal Film, Monochrome, Cross Processing
Cross Processing	Random, Preset 1-3, Favorite 1-3
Digital Filter	Extract Color, Replace Color, Toy Camera, Retro, High Contrast, Shading, Invert Color, Unicolor Bold, Bold Monochrome
HDR Capture • Available only for Interval Movie Record	Auto, Type1, Type2, Type3 Bracket Value adjustable
Clarity Enhancement • Available only for Interval Movie Record	On, Off

### Playback Functions

Playback View	Single frame, Multi-image display (6, 12, 20, 35, and 80 thumbnails), Image magnification (Up to 16x, quick zoom), Rotated image display, Histogram (Y histogram, RGB histogram), Highlight Alert, Detailed Information Display, Copyright Information (Photographer, Copyright Holder), GPS information (Latitude, Longitude, Altitude, Coordinated Universal Time (UTC)), Direction, Folder Display, Calendar Filmstrip Display, Slideshow
Delete	Single image, all images, select & delete, folder, Instant Review image
Digital Filter	Base Parameter Adj, Extract Color, Replace Color, Toy Camera, Retro, High Contrast, Shading, Invert Color, Unicolor Bold, Bold Monochrome, Tone Expansion, Sketch, Water Color, Pastel, Posterization, Miniature, Soft, Starburst, Fish-eye, Slim, Monochrome

RAW Development	Development options: Select single image, Select multiple images, Select a folder Development parameters: File Format (JPEG), Aspect Ratio, JPEG Recorded Pixels, JPEG Quality, Color Space, Distortion Correction, Peripheral Illumin. Corr., Lat-Chromatic-Ab Adj, Diffraction Correction, Color Fringe Correction, White Balance, Custom Image, Digital Filter, Clarity Enhancement, Sensitivity, High-ISO NR, Shadow Correction
Editing Features	Image Rotation, Color Moiré Correction, Resize, Cropping (aspect ratio can be changed and tilt correction is available), Movie Edit (dividing a movie file and deleting unwanted segments), Capturing a JPEG still picture from a movie, Save RAW Data

### Customization

USER Mode	Up to 2 settings can be saved.
Custom Functions	28 items
Mode Memory	12 items
E-Dial Programming	E-dials (front/rear): customizable to each exposure mode
Button Customization	<b>RAW/F</b> button: One Push File Format, Bracketing, Optical Preview, Digital Preview, Shake Reduction, AF Active Area <b>AF/AE</b> button: Enable AF1, Enable AF2, Cancel AF, AE Lock (can be customized for taking still pictures and for recording movies separately) Self-portrait shutter button: On, Off
AF Customization	AF.S Setting: Focus-priority, Release-priority 1st Frame Action in AF.C: Release-priority, Auto, Focus-priority Action in AF.C Continuous: Focus-priority, Auto, FPS-priority Hold AF Status: Off, Low, Medium, High AF in Interval Shooting: Locks focus at 1st exposure, Adjusts focus for each shot
Text Size	Standard, Large
World Time	World Time settings for 75 cities (28 time zones)
AF Fine Adjustment	±10 steps, adjustment for all lenses or individual lenses (up to 20 values can be saved)

Copyright Information	Names of "Photographer" and "Copyright Holder" are embedded to the image file. A revision history can be checked using the provided software.
-----------------------	---

#### Power Supply

Battery Type	Rechargeable Lithium-ion Battery D-LI109
AC Adapter	AC Adapter Kit K-AC128 (optional)
Battery Life	<p>Number of recordable images: (with 50% flash usage): approx. 410 images, (without flash usage): approx. 480 images Playback time: approx. 270 minutes</p> <ul style="list-style-type: none"> <li>Tested in compliance with CIPA standard using a fully charged lithium-ion battery at a temperature of 23°C. Actual results may vary depending on the shooting conditions/circumstances.</li> </ul>

#### Interfaces

Connection Port	USB 2.0 (micro B), HDMI output terminal (Type D), stereo microphone input terminal
USB Connection	MSC/PTP

#### Wireless LAN

Standards	IEEE 802.11b/g/n (standard wireless LAN protocol)
Frequency (Center Frequency)	2412 to 2462 MHz (channels: Ch 1 to Ch 11)
Security	Authentication: WPA2 Encryption: AES

#### NFC

Standards	ISO/IEC14443 TypeA, ISO/IEC14443 TypeB, JIS X 6319-4 (automatically selected)
Operating Frequency	13.56 MHz

#### Dimensions and Weight

Dimensions	Approx. 122.5 mm (W) × 91 mm (H) × 72.5 mm (D) (excluding protrusions)
Weight	Approx. 678 g (Including dedicated battery and SD Memory Card) Approx. 618 g (body only)

#### Included Accessories

Package Contents	Strap O-ST132, Rechargeable Lithium-ion Battery D-LI109, Battery Charger D-BC109, AC plug cord, Software (CD-ROM) S-SW156, Start Guide <Mounted to the camera> Eyecup Fr, Hot shoe cover F <sub>K</sub> , Body mount cover
Software	Digital Camera Utility 5

#### Optional Accessories

GPS Unit	O-GPS1: GPS information (Latitude, Longitude, Altitude, Coordinated Universal Time (UTC)), Direction, Electronic Compass, ASTROTRACER
----------	---

## Approximate Image Storage Capacity and Playback Time

(When using the fully charged battery)

Battery	Temperature	Normal Shooting	Flash Photography		Playback Time
			50% Use	100% Use	
D-LI109	23°C	480	410	360	270 minutes

- The image storage capacity (normal recording and flash use 50%) is based on measuring conditions in accordance with CIPA standards, while other data is based on our measuring conditions. Some deviation from the above figures may occur in actual use depending on the selected capture mode and shooting conditions.

## Approximate Image Storage Capacity by Size

(When using a 2 GB memory card)

Recorded Pixels	JPEG Quality			PEF	DNG
	★★★	★★	★		
20M	134	304	596	59	59
12M	224	503	975	–	–
6M	418	917	1707	–	–
2M	1024	2119	3615	–	–

- The number of storable images may vary depending on the subject, shooting conditions, selected capture mode and memory card, etc.

## Operating Environment for USB Connection and Provided Software

With the provided software “Digital Camera Utility 5”, you can develop RAW files, make color adjustments, or check shooting information on a computer. Install the software from the provided CD-ROM (S-SW156).

We recommend the following system requirements to connect the camera to a computer and to use the software.

### Windows

<b>OS</b>	Windows 8.1 (32-bit, 64-bit), Windows 8 (32-bit, 64-bit), Windows 7 (32-bit, 64-bit), or Windows Vista (32-bit, 64-bit)
<b>CPU</b>	Intel Core 2 Duo or higher
<b>RAM</b>	2 GB or more
<b>HDD</b>	For installing and starting up the program: 100 MB or more of available space For saving image files: Approx. 10 MB/file (JPEG), Approx. 20 MB/file (RAW)
<b>Monitor</b>	1280×1024 dots, 24-bit full color or higher

### Memo

























- QuickTime is required to play back movies transferred to a computer with an OS other than Windows 8 and Windows 8.1. (A computer with Windows 8 or Windows 8.1 can play back movies with a pre-installed player software.)  
You can download it from the following site:  
<http://www.apple.com/quicktime/download/>

## Macintosh

<b>OS</b>	OS X 10.10, 10.9, 10.8, or 10.7
<b>CPU</b>	Intel Core 2 Duo or higher
<b>RAM</b>	2 GB or more
<b>HDD</b>	For installing and starting up the program: 100 MB or more of available space For saving image files: Approx. 10 MB/file (JPEG), Approx. 20 MB/file (RAW)
<b>Monitor</b>	1280×1024 dots, 24-bit full color or higher

# Index

## Symbols

 menu.....	12
 menu.....	15
 menu.....	16
 menu.....	17
 menu.....	19
 mode.....	33
 Portrait.....	30
 Landscape.....	30
 Macro.....	30
 Moving Object.....	30
 Night Scene Portrait ..	30
 Sunset.....	30
 Blue Sky.....	30
 Forest.....	30
 Night Scene.....	30
 Night Scene HDR.....	30
 Night Snap.....	30
 Food.....	30
 Pet.....	30
 Kids.....	30
 Surf & Snow.....	30
 Backlight Silhouette ...	30
 Candlelight.....	30
 Stage Lighting.....	30
 Museum.....	30

## Numerics

1st Frame Action in AF.C .....	20
-----------------------------------	----

## A

AA Filter Simulator .....	13
Action in AF.C Continuous .....	20
Advanced HDR mode.....	31
AE Metering.....	12
AE-L with AF Locked.....	19
AF Active Area .....	12
AF assist light.....	3, 12
AF coupler.....	3
AF Fine Adjustment.....	20
AF frame.....	27, 28
AF in Interval Shooting .....	19
AF Mode.....	12
AF Settings.....	12
AF with Remote Control ..	20
AF.S Setting .....	20
<b>A-HDR</b> mode.....	31
Aperture Priority Automatic Exposure .....	31
Aperture value .....	31
Auto EV Compensation ...	19
Auto Flash Discharge.....	34
Auto Image Rotation.....	16
<b>AUTO</b> mode.....	26
Auto Picture mode.....	26
Auto Power Off.....	18
<b>Av</b> mode .....	31
<b>AWB</b> .....	36
AWB in Tungsten Light... 19	

## B

<b>B</b> mode.....	31
Backlight Silhouette ( <b>SCN</b> ) .....	30
Battery .....	22
Blue Sky ( <b>SCN</b> ).....	30
Bracketing .....	35
Bracketing Order .....	19
Built-in flash.....	34
Bulb (B) Mode Options ...	19
Bulb Exposure .....	31
Button .....	4
Button Customization .....	15
<b>C</b>	
Candlelight ( <b>SCN</b> ).....	30
Capture mode.....	29
Card.....	23
Card access lamp.....	3
Catch-in Focus .....	20
Certification Marks.....	18, 57
Charging the battery.....	22
City names .....	24
Clarity Enhancement .....	13, 15
Cloudy (White Balance)...	36
Color Moiré Correction ...	38
Color Space.....	20
Color Temperature .....	36
Color Temperature Steps .....	20

Communication device ....	39
Continuous Shooting .....	35
Control panel .....	8, 10
Copyright Information .....	17
Create New Folder .....	17
Cropping.....	38
<b>CTE</b> .....	36
Custom Image .....	12
Custom Setting menus ...	19
<b>D</b>	
Date Adjustment.....	17
Date/Time.....	24
Daylight (White Balance) .....	36
Delete .....	37
Delete All Images .....	16
Dial .....	4
Dial indicator.....	27
Digital Camera Utility 5....	49
Digital Filter.....	12, 15, 38
Diopter adjustment lever... 9	
Direct keys.....	10
Display Color .....	25
D-Range Settings .....	13
Drive Mode .....	35
DST (daylight saving time) .....	24
Dust Removal.....	18

<b>E</b>		<b>H</b>		<b>L</b>		Movie Edit.....	38
E-Dial Programming .....	14	HDMI Out .....	17	Landscape ( <b>SCN</b> ) .....	30	Movie menu .....	15
Electronic Level .....	9, 13	HDMI terminal .....	3	Language .....	24	Movie SR .....	15
EV Compensation .....	33	HDR Capture.....	12, 15, 31	Language/言語 .....	17, 24	Moving Object ( <b>SCN</b> ).....	30
EV Steps .....	19	High-ISO NR .....	13	LCD Display .....	17, 25	Multi Auto White Balance	
Exposure Mode .....	12	Highlight Alert .....	13, 16	LCD Display Settings .....	17	(White Balance).....	36
Exposure modes .....	31	Histogram Display .....	13	Lens.....	21, 43	Multi-exposure .....	35
		Hold AF Status .....	20	Lens Correction .....	13	Museum ( <b>SCN</b> ).....	30
<b>F</b>		Hometown .....	24	Lens information contacts			
File Format .....	12	Horizon Correction .....	13	.....	3	<b>N</b>	
File Name .....	17	Hot shoe .....	3	Lens mount index .....	21	NFC mark .....	3, 39
File No. ....	17			Lens unlock button .....	21	Night Scene ( <b>SCN</b> ).....	30
Firmware Info/Options ....	18	<b>I</b>		Link AE and AF Point .....	19	Night Scene HDR ( <b>SCN</b> )	
Flash.....	34	Image Capture Settings... ..	12	Live View .....	7, 13	.....	30
Flash (White Balance) ....	36	Image plane indicator .....	3			Night Scene Portrait ( <b>SCN</b> )	
Flash compensation .....	35	Image Rotation .....	38	<b>M</b>		.....	30
Flash On.....	34	Image storage capacity ... ..	49	<b>M</b> mode .....	31	Night Snap ( <b>SCN</b> ).....	30
Flicker Reduction.....	18	Image Sync .....	39	Macintosh .....	50		
Fluorescent (White Balance)		Indicator Lamps.....	18	Macro ( <b>SCN</b> ).....	30	<b>O</b>	
.....	36	Initial settings.....	24	Magnifying images .....	37	One-Push Bracketing .....	19
Focus indicator .....	27	Initializing a memory card		Manual Exposure .....	31	Operating environment....	49
Focus mode.....	27	.....	26	Manual Flash Discharge..	34	Operating Manual.....	63
Folder Name.....	17	Input Focal Length.....	13	Manual White Balance ... ..	36		
Food ( <b>SCN</b> ).....	30	Instant Review .....	14, 27	Memory .....	15	<b>P</b>	
Forest ( <b>SCN</b> ).....	30	Interval Composite .....	35	Memory card .....	23	<b>P</b> mode .....	31
Format.....	18, 26	Interval Movie Record .....	36	Menu .....	11	Pet ( <b>SCN</b> ) .....	30
Four-way controller.....	5	Interval Shooting .....	35	Meter Operating Time .....	19	Pixel Mapping .....	18
Function restrictions .....	40	Interval Shooting Options		Microphone.....	3	Playback Info Display	
		.....	19	Mirror .....	3	selection screen.....	8
<b>G</b>		ISO sensitivity.....	32	Mode dial .....	27	Playback menu.....	16
Getting the camera ready		<b>K</b>		Monitor .....	6, 23	Playback mode .....	37
.....	21	Kids ( <b>SCN</b> ).....	30	Mount type.....	43	Playback mode palette ....	38
GPS.....	13			Movie .....	33	Portrait ( <b>SCN</b> ) .....	30
Grid Display .....	13			Movie Capture Settings ... ..	15	Power .....	24
Guide Display .....	27						

Program Automatic Exposure .....	31	SD Memory Card.....	23	Star Stream .....	36	Windows .....	49
Protect .....	38	Self-portrait Shutter Button .....	28, 39	Status Screen .....	7	Wireless LAN.....	38
Protect All Images .....	16	Self-timer .....	35	Still picture .....	29	World Time .....	17
Provided software.....	49	Sensitivity .....	32	Strap.....	21		
<b>Q</b>		Sensitivity Priority Automatic Exposure .....	31	Sunset ( <b>SCN</b> ).....	30		
Quality .....	12	Sensitivity Steps .....	19	Superimpose AF Area ....	20		
Quick Zoom .....	16	Sensor Cleaning .....	18	Surf & Snow ( <b>SCN</b> ).....	30		
QuickTime .....	49	Set-up menus .....	17	<b>Sv</b> mode .....	31		
<b>R</b>		Shade (White Balance) ...	36	Switch .....	4		
RAW Development.....	38	Shake Reduction .....	13	<b>T</b>			
Rec. Mode menus .....	12	Sharing .....	38	Taking a self-portrait.....	28		
Recordable time .....	33	Shooting .....	26	<b>TAv</b> mode.....	31		
Recorded Pixels .....	12	Shooting Info Display .....	6	Text Size .....	17, 25		
Recording Sound Level ...	15	Shooting with Live View ..	28	Thumbnail display .....	37		
Red-eye Reduction.....	34	Shooting with viewfinder..	26	Trailing Curtain Sync .....	34		
Release While Charging..	20	Shutter & Aperture Priority Automatic Exposure .....	31	Tungsten (White Balance) .....	36		
Remote Control .....	35	Shutter Priority Automatic Exposure .....	31	<b>Tv</b> mode.....	31		
Remote control receiver ....	3	Shutter speed .....	31	<b>U</b>			
Reset .....	18, 20	Single Frame Shooting ....	35	USB Connection.....	17, 49		
Resize .....	38	Single image display ...	8, 37	USB terminal .....	3		
Retractable lens .....	26	Slideshow .....	16, 38	User registration .....	2		
<b>S</b>		Slow Shutter Speed NR ..	13	Using Aperture Ring .....	20		
<b>SCN</b> mode .....	30	Slow-speed Sync.....	34	<b>V</b>			
Save as Manual WB .....	38	Software .....	49	Viewfinder .....	9		
Save Cross Processing ...	38	Sound .....	33	<b>W</b>			
Save Menu Location.....	20	Sound Effects .....	17	WARRANTY POLICY.....	60		
Save RAW Data .....	27, 37	Speaker .....	3	WB Adjustable Range ....	19		
Save Rotation Info .....	20	Specifications .....	44	WB When Using Flash ....	19		
Save USER Mode .....	15	Stage Lighting ( <b>SCN</b> ).....	30	White Balance .....	36		
Scene Mode .....	12	Standby mode .....	6	Wi-Fi .....	18, 38		
Scene modes .....	30						

## For Using Your Camera Safely

We have paid close attention to the safety of this camera. When using this camera, we request your special attention regarding items marked with the following symbols.



### Warning

This symbol indicates that ignoring this item could cause serious personal injuries.



### Caution

This symbol indicates that ignoring this item could cause minor or medium personal injuries, or loss of property.

## About the Camera



### Warning

- Do not disassemble or modify the camera. High voltage areas are present inside the camera, with the risk of electric shock.
- If the camera interior is exposed due to dropping or otherwise damaging the camera, never touch the exposed portion. There is a risk of electric shock.
- Do not aim the camera at the sun or other strong light sources when taking pictures or leave the camera sitting in direct sunlight with a lens cap off. Doing so may cause the camera to malfunction or cause a fire.
- Do not look at the sun or other strong light sources through a lens. Doing so may lead to a loss of eyesight or cause vision to be impaired.
- If any irregularities occur during use, such as smoke or a strange odor, stop use immediately, remove the battery or the AC adapter, and contact your nearest service center. Continued use can cause a fire or electrical shock.



### Caution

- Do not place your finger over the flash when discharging the flash. You may burn yourself.
- Do not cover the flash with clothing when discharging the flash. Discoloration may occur.
- Some portions of the camera heat up during use. There is a risk of low temperature burns when holding such portions for long periods.

- Should the monitor be damaged, be careful of glass fragments. Also, be careful not to allow the liquid crystal to get on your skin or in your eyes or mouth.
- Depending on your individual factors or physical condition, the use of the camera may cause itching, rashes or blisters. In case of any abnormality, stop using the camera and get medical attention immediately.

## About the Battery Charger and AC Adapter



### Warning

- Always use the battery charger and AC adapter exclusively developed for this camera, with the specified power and voltage. Using a battery charger or AC adapter not exclusive to this camera, or using the exclusive battery charger or AC adapter with an unspecified power or voltage can cause a fire, electric shock, or camera breakdown. The specified voltage is 100 - 240V AC.
- Do not disassemble or modify the product. This can cause a fire or electrical shock.
- If the generation of smoke or strange odor from the product or other abnormality occurs, immediately discontinue using and consult your nearest service center. Continued use can cause a fire or electrical shock.
- If water should happen to get inside the product, consult your nearest service center. Continued use can cause a fire or electrical shock.
- If you see a lightning flash or hear thunder during use of the battery charger or AC adapter, unplug the power plug and discontinue using. Continued use can cause damage to the product, fire or electrical shock.
- Wipe off the power plug if it should become covered with dust. Accumulated dust may cause a fire.
- To reduce the risk of hazards, use only CSA/UL certified power supply cord set, cord is Type SPT-2 or heavier, minimum NO.18 AWG copper, one end with a molded-on male attachment plug cap (with a specified NEMA configuration), and the other is provided with a molded-on female connector body (with a specified IEC nonindustrial type configuration) or the equivalent.



### Caution

- Do not place or drop heavy objects on or forcefully bend the AC plug cord. Doing so may damage the cord. Should the AC plug cord be damaged, consult your nearest service center.



- Do not touch or short-circuit the terminal area of the AC plug cord while the cord is plugged in.
- Do not handle the power plug with wet hands. This can cause an electric shock.
- Do not drop the product, or subject it to violent impact. This can cause the product to breakdown.
- Do not use the battery charger D-BC109 to charge batteries other than the rechargeable lithium-ion battery D-LI109. Attempting to charge other types of batteries may cause an explosion or heating, or may damage the battery charger.

## About the Rechargeable Lithium-ion Battery

### Warning

- If any leakage from the battery should come in contact with your eyes, do not rub them. Flush your eyes with clean water and get medical attention immediately.

### Caution

- Only use the specified battery with this camera. Use of other batteries may cause an explosion or fire.
- Do not disassemble the battery. Disassembling the battery may cause an explosion or leakage.
- Remove the battery from the camera immediately if it becomes hot or begins to smoke. Be careful not to burn yourself during removal.
- Keep wires, hairpins, and other metal objects away from the + and - contacts of the battery.
- Do not short the battery or dispose of the battery in fire. This can cause an explosion or fire.
- If any leakage from the battery should come in contact with skin or clothing, it may cause irritation to the skin. Wash the affected areas thoroughly with water.
- Precautions for D-LI109 Battery Usage:
  - USE SPECIFIED CHARGER ONLY.
  - DO NOT INCINERATE.
  - DO NOT DISASSEMBLE.
  - DO NOT SHORT CIRCUIT.
  - DO NOT EXPOSE TO HIGH TEMP. (140°F / 60°C)

## Keep the Camera and its Accessories out of the Reach of Small Children

### Warning

- Do not place the camera and its accessories within the reach of small children.
  1. If the product falls or is operated accidentally, it may cause serious personal injuries.
  2. Wrapping the strap around a neck may cause suffocation.
  3. To avoid the risk of a small accessory such as the battery or memory cards from being swallowed by mistake, keep them out of the reach of small children. Seek medical attention immediately if an accessory is accidentally swallowed.

## Care to be Taken During Handling

### Before Using Your Camera

- When the camera has not been used for a long time, confirm that it is still working properly, particularly prior to taking important pictures (such as at a wedding or when traveling). Contents of the recording cannot be guaranteed if recording, playback or transferring your data to a computer, etc. is not possible due to a malfunction of your camera or recording media (memory cards), etc.

### About the Battery and Charger

- To keep the battery in optimum condition, avoid storing it in a fully charged state or in high temperatures.
- If the battery is left inserted and the camera is not used for a long time, the battery will over-discharge and shorten the battery's life.
- Charging the battery a day before use or on the day of use is recommended.
- The AC plug cord provided with this camera is developed exclusively for the battery charger D-BC109. Do not use it with other devices.

### Precautions on Carrying and Using Your Camera

- Do not subject the camera to high temperatures or high humidity. Do not leave the camera in a vehicle, as the temperature can get very high.
- Do not subject the camera to strong vibrations, shocks, or pressure. Use a cushion to protect the camera from vibrations of motorcycles, automobiles, or ships.
- The temperature range for camera use is -10°C to 40°C (14°F to 104°F).
- The monitor may appear black at high temperatures, but will return to normal at normal temperatures.
- The monitor may respond more slowly at low temperatures. This is due to liquid crystal properties, and is not a malfunction.
- Sudden temperature changes will cause condensation on the inside and outside of the camera. Place the camera in your bag or a plastic bag, and remove it after temperatures of the camera and surroundings are equalized.

- Avoid contact with garbage, mud, sand, dust, water, toxic gases, or salt. These could cause the camera to breakdown. Wipe the camera to dry off any rain or water drops.
- Do not press on the monitor with excessive force. This could cause it to break or malfunction.
- Be careful not to overtighten the screw in the tripod socket when using a tripod.

### Cleaning Your Camera

- Do not clean the camera with organic solvents such as thinner, alcohol, and benzine.
- Use a lens brush to remove dust accumulated on the lens. Never use a spray blower for cleaning as it may damage the lens.
- Please contact your nearest service center for professional cleaning of the CMOS sensor. (This will involve a fee.)
- Periodic inspections are recommended every one to two years to maintain high performance.

### Storing Your Camera

- Do not store the camera with preservatives or chemicals. Storage in high temperatures and high humidity can cause mold to grow on the camera. Remove the camera from its case and store it in a dry and well-ventilated place.
- Avoid using or storing the camera where it may be exposed to static electricity or electrical interference.
- Avoid using or storing the camera in direct sunlight or in locations where it may be exposed to rapid changes in temperature or to condensation.

## About SD Memory Cards

- The SD Memory Card is equipped with a write-protect switch. Setting the switch to LOCK prevents new data from being recorded on the card, the stored data from being deleted, and the card from being formatted by the camera or computer.
- The SD Memory Card may be hot when removing the card immediately after using the camera.
- Do not remove the SD Memory Card or turn off the power while the card is being accessed. This may cause the data to be lost or the card to be damaged.
- Do not bend the SD Memory Card or subject it to violent impact. Keep it away from water and store away from high temperatures.
- Do not remove the SD Memory Card while formatting. The card may be damaged and become unusable.
- Data on the SD Memory Card may be deleted in the following circumstances. We do not accept any liability for data that is deleted if
  1. the SD Memory Card is mishandled by the user.
  2. the SD Memory Card is exposed to static electricity or electrical interference.
  3. the SD Memory Card has not been used for a long time.
  4. the SD Memory Card or the battery is removed while the card is being accessed.
- If the SD Memory Card is not used for a long time, the data on the card may become unreadable. Be sure to regularly make a backup of important data on a computer.
- Format new SD Memory Cards. Also format SD Memory Cards previously used with other cameras.
- Please note that deleting data stored on an SD Memory Card, or formatting an SD Memory Card does not completely erase the original data. Deleted data can sometimes be recovered using commercially available software. If you are going to discard, give away or sell your SD Memory Card, you should ensure that the data on the card is completely deleted or the card itself is destroyed if it contains any personal or sensitive information.
- The data on your SD Memory Card should be managed at your own risk.

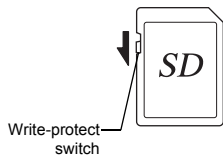

## About the Wireless LAN Function

- Do not use the camera in a place where electrical products, AV/OA devices, and so on generate magnetic fields and electromagnetic waves.
- If the camera is affected by magnetic fields and electromagnetic waves, it may not be able to communicate.
- If the camera is used near a TV or a radio, poor reception or TV screen glitch may occur.
- If there are multiple wireless LAN access points near the camera and the same channel is used, search operation may not be executed correctly.
- The security of your data stored, sent or received is your own responsibility.

In the frequency band used by the camera, along with industrial, scientific, and medical devices such as a microwave oven, premises radio stations (wireless stations requiring license) and specified low power radio stations (wireless stations not requiring license) for mobile object identification used in factory production lines, etc., and amateur radio stations (wireless stations requiring license) are operated.

1. Before using the camera, confirm that premises radio stations and specified low power radio stations for mobile object identification and amateur radio stations are not operated in the vicinity.
2. In the event that the camera causes harmful radio wave interference to premises radio stations for mobile object identification, immediately change the frequency being used to avoid interference.
3. If you have other troubles such that the camera causes harmful radio wave interference to specified low power radio stations for mobile object identification or to amateur radio stations, contact your nearest service center.

This camera conforms to the technical standards under the Radio Law and Telecommunications Business Law and the certification of conformance to technical standards can be displayed on the monitor.

The certification marks of conformance to wireless technical standards can be displayed from [Certification Marks] of the  4 menu. Refer to "Using the Menus" (p.11) for how to use the menus.

## Trademarks

- Microsoft, Windows, Windows Vista, and Photosynth are registered trademarks of Microsoft Corporation in the United States of America and other countries.
- Macintosh, OS X, QuickTime, iPhone, and App Store are trademarks of Apple Inc., registered in the U.S. and other countries.
- Intel and Intel Core are trademarks of Intel Corporation in the U.S. and/or other countries.
- SDXC Logo is a trademark of SD-3C, LLC.
- Google, Google Play, and Android are trademarks or registered trademarks of Google Inc.
- Wi-Fi is a registered trademark of Wi-Fi Alliance.
- The N-Mark is a trademark or registered trademark of NFC Forum, Inc. in the United States and in other countries.
- iOS is a trademark or registered trademark of Cisco in the U.S. and other countries and is used under license.
- Facebook is a registered trademark of Facebook, Inc.
- Twitter is a registered trademark of Twitter, Inc.
- Tumblr is a registered trademark of Tumblr, Inc.
- This product includes DNG technology under license by Adobe Systems Incorporated.
- The DNG logo is either a registered trademark or trademark of Adobe Systems Incorporated in the United States and/or other countries.
- HDMI, the HDMI logo and High-Definition Multimedia Interface are trademarks or registered trademarks of HDMI Licensing, LLC in the United States and/or other countries.

All other trademarks are the property of their respective owners.

- This product uses the RICOH RT font designed by Ricoh Company Ltd.
  - This product supports PRINT Image Matching III. PRINT Image Matching enabled digital still cameras, printers and software help photographers to produce images more faithful to their intentions. Some functions are not available on printers that are not PRINT Image Matching III compliant.
- Copyright 2001 Seiko Epson Corporation. All Rights Reserved. PRINT Image Matching is a trademark of Seiko Epson Corporation. The PRINT Image Matching logo is a trademark of Seiko Epson Corporation.



### AVC Patent Portfolio License

This product is licensed under the AVC Patent Portfolio License for the personal use of a consumer or other uses in which it does not receive remuneration to (i) encode video in compliance with the AVC standard ("AVC video") and/or (ii) decode AVC video that was encoded by a consumer engaged in a personal activity and/or was obtained from a video provider licensed to provide AVC video. No license is granted or shall be implied for any other use.

Additional information may be obtained from MPEG LA, L.L.C.  
See <http://www.mpegla.com>.

## Announcement on the Use of BSD-Licensed Software

This product includes software licensed under the BSD License. BSD license is a form of license which permits the redistribution of the software provided that it is clearly stated that use is unwarranted, and a copyright notice and a list of licensing conditions are provided. The following contents are displayed based on the abovementioned licensing conditions and are not for the purpose of restricting your use of the product, etc.

Tera Term

Copyright (c) T.Teranishi.

Copyright (c) TeraTerm Project.

All rights reserved.

Redistribution and use in source and binary forms, with or without modification, are permitted provided that the following conditions are met:

1. Redistributions of source code must retain the above copyright notice, this list of conditions and the following disclaimer.
2. Redistributions in binary form must reproduce the above copyright notice, this list of conditions and the following disclaimer in the documentation and/or other materials provided with the distribution.
3. The name of the author may not be used to endorse or promote products derived from this software without specific prior written permission.

THIS SOFTWARE IS PROVIDED BY THE AUTHOR "AS IS" AND ANY EXPRESS OR IMPLIED WARRANTIES, INCLUDING, BUT NOT LIMITED TO, THE IMPLIED WARRANTIES OF MERCHANTABILITY AND FITNESS FOR A PARTICULAR PURPOSE ARE DISCLAIMED. IN NO EVENT SHALL THE AUTHOR BE LIABLE FOR ANY DIRECT, INDIRECT, INCIDENTAL, SPECIAL, EXEMPLARY, OR CONSEQUENTIAL DAMAGES (INCLUDING, BUT NOT LIMITED TO, PROCUREMENT OF SUBSTITUTE GOODS OR SERVICES; LOSS OF USE, DATA, OR PROFITS; OR BUSINESS INTERRUPTION) HOWEVER CAUSED AND ON ANY THEORY OF LIABILITY, WHETHER IN CONTRACT, STRICT LIABILITY, OR TORT (INCLUDING NEGLIGENCE OR OTHERWISE) ARISING IN ANY WAY OUT OF THE USE OF THIS SOFTWARE, EVEN IF ADVISED OF THE POSSIBILITY OF SUCH DAMAGE.

## WARRANTY POLICY

All our cameras purchased through authorized bona fide photographic distribution channels are guaranteed against defects of material or workmanship for a period of twelve months from the date of your purchase. Service will be rendered, and defective parts will be replaced without cost to you within that period, provided the camera does not show evidence of impact, sand or liquid damage, mishandling, tampering, battery or chemical corrosion, operation contrary to operating instructions, or modification by an unauthorized repair shop. The manufacturer or its authorized representatives shall not be liable for any repair or alterations except those made with its written consent and shall not be liable for damages from delay or loss of use or from other indirect or consequential damages of any kind, whether caused by defective material or workmanship or otherwise; and it is expressly agreed that the liability of the manufacturer or its representatives under all guarantees or warranties, whether expressed or implied, is strictly limited to the replacement of parts as hereinbefore provided. No refunds will be made on repairs by non-authorized service facilities.

### Procedure During 12-month Warranty Period

Any camera which proves defective during the 12-month warranty period should be returned to the dealer from whom you purchased the camera or to the manufacturer. If there are no representatives of the manufacturer in your country, send the camera to the manufacturer, with postage prepaid. In this case, it will take a considerable length of time before the camera can be returned to you owing to the complicated customs procedures required. If the camera is covered by warranty, repairs will be made and parts replaced free of charge, and the

camera will be returned to you upon completion of servicing. If the camera is not covered by warranty, regular charges of the manufacturer or of its representatives will apply. Shipping charges are to be borne by the owner. If your camera was purchased outside of the country where you wish to have it serviced during the warranty period, regular handling and servicing fees may be charged by the manufacturer's representatives in that country. Notwithstanding this, your camera returned to the manufacturer will be serviced free of charge according to this procedure and warranty policy. In any case, however, shipping charges and customs clearance fees to be borne by the sender. To prove the date of your purchase when required, please keep the receipt or bills covering the purchase of your camera for at least a year. Before sending your camera for servicing, please make sure that you are sending it to the manufacturer's authorized representatives or their approved repair shops, unless you are sending it directly to the manufacturer. Always obtain a quotation for the service charge, and only after you accept the quoted service charge, instruct the service station to proceed with the servicing.

- **This warranty policy does not affect the customer's statutory rights.**
- **The local warranty policies available from our distributors in some countries can supersede this warranty policy. Therefore, we recommend that you review the warranty card supplied with your product at the time of purchase, or contact our distributor in your country for more information and to receive a copy of the warranty policy.**

## For customers in USA

### STATEMENT OF FCC COMPLIANCE

This device complies with Part 15 of the FCC Rules. Operation is subject to the following two conditions: (1) This device may not cause harmful interference, and (2) this device must accept any interference received, including interference that may cause undesired operation.

Changes or modifications not approved by the party responsible for compliance could void the user's authority to operate the equipment.

This equipment has been tested and found to comply with the limits for a Class B digital device, pursuant to part 15 of the FCC Rules.

These limits are designed to provide reasonable protection against harmful interference in a residential installation. This equipment generates, uses and can radiate radio frequency energy and, if not installed and used in accordance with the instructions, may cause harmful interference to radio communications. However, there is no guarantee that interference will not occur in a particular installation.

If this equipment does cause harmful interference to radio or television reception, which can be determined by turning the equipment off and on, the user is encouraged to try to correct the interference by one or more of the following measures:

- Reorient or relocate the receiving antenna.
- Increase the separation between the equipment and receiver.
- Connect the equipment into an outlet on a circuit different from that to which the receiver is connected.

\* Consult the dealer or an experienced radio/TV technician for help.

## FOR CALIFORNIA, U.S.A. ONLY

Perchlorate Material-special handling may apply.

The lithium battery used in this camera contains perchlorate material, which may require special handling.

See [www.dtsc.ca.gov/hazardouswaste/perchlorate](http://www.dtsc.ca.gov/hazardouswaste/perchlorate)

## For customers in Canada

### Industry Canada (IC) Compliance Notice

This Class B digital apparatus complies with Canadian ICES-003.

This device complies with Industry Canada licence-exempt RSS standard(s). Operation is subject to the following two conditions: (1) this device may not cause interference, and (2) this device must accept any interference, including interference that may cause undesired operation of the device.

## Pour les utilisateurs au Canada

### Industrie Canada (IC) Avis de Conformité

Cet appareil numérique de la classe B est conforme à la norme NMB-003 du Canada.

Le présent appareil est conforme aux CNR d'Industrie Canada applicables aux appareils radio exempts de licence.

L'exploitation est autorisée aux deux conditions suivantes :

- (1) l'appareil ne doit pas produire de brouillage, et
- (2) l'utilisateur de l'appareil doit accepter tout brouillage radioélectrique subi, même si le brouillage est susceptible d'en compromettre le fonctionnement.

# Declaration of Conformity

According to 47CFR, Parts 2 and 15 for  
Class B Personal Computers and Peripherals

We: RICOH IMAGING AMERICAS  
CORPORATION

Located at: 633 17<sup>th</sup> Street, Suite 2600  
Denver, Colorado 80202 U.S.A.  
Phone: 800-877-0155  
FAX: 303-790-1131

Declare under sole responsibility that the product identified herein complies with 47CFR Parts 2 and 15 of the FCC rules as a Class B digital device. Each product marketed is identical to the representative unit tested and found to be compliant with the standards. Records maintained continue to reflect the equipment being produced can be expected to be within the variation accepted, due to quantity production and testing on the statistical basis as required by 47CFR §2.909. Operation is subject to the following two conditions: (1) This device may not cause harmful interference, and (2) This device must accept any interference received, including interference that may cause undesired operation. The above named party is responsible for ensuring that the equipment complies with the standards of 47CFR §15.101 to §15.109.

Product Name: SLR Digital Camera  
Model Number: PENTAX K-S2  
Contact person: Customer Service Manager  
Date and Place: January, 2015, Colorado

## Information for Users on Collection and Disposal of Old Equipment and Used Batteries



### 1. In the European Union

These symbols on the products, packaging and/or accompanying documents mean that used electrical and electronic equipment and batteries should not be mixed with general household waste.

Used electrical/electronic equipment and batteries must be treated separately and in accordance with legislation that requires proper treatment, recovery and recycling of these products.



By disposing of these products correctly you will help ensure that the waste undergoes the necessary treatment, recovery and recycling and thus prevent potential negative effects on the environment and human health which could otherwise arise due to inappropriate waste handling.

If a chemical symbol is added beneath the symbol shown above, in accordance with the Battery Directive, this indicates that a heavy metal (Hg = Mercury, Cd = Cadmium, Pb = Lead) is present in the battery at a concentration above an applicable threshold specified in the Battery Directive.

For more information about collection and recycling of used products, please contact your local authorities, your waste disposal service or the point of sale where you purchased the products.



## 2. In other countries outside the EU

These symbols are only valid in the European Union. If you wish to discard used products, please contact your local authorities or dealer and ask for the correct method of disposal.

For Switzerland: Used electrical/electronic equipment can be returned free of charge to the dealer, even when you don't purchase a new product. Further collection facilities are listed on the home page of [www.swico.ch](http://www.swico.ch) or [www.sens.ch](http://www.sens.ch).



The CE Mark is a Directive conformity mark of the European Union.

## Information on the Operating Manual

An Operating Manual (PDF) containing information on how to use this camera is available. Please download it from our website.

**Operating Manual Download:**  
<http://www.ricoh-imaging.com/manuals/>



**Memo**

**Memo**

**RICOH IMAGING COMPANY, LTD.**

2-35-7, Maeno-cho, Itabashi-ku, Tokyo 174-8639, JAPAN  
(<http://www.ricoh-imaging.co.jp>)

**RICOH IMAGING EUROPE  
S.A.S** 112 Quai de Bezons, B.P. 204, 95106 Argenteuil Cedex, FRANCE  
(<http://www.ricoh-imaging.fr>)

**RICOH IMAGING  
DEUTSCHLAND GmbH** Am Kaiserhai 1, 20457 Hamburg, GERMANY  
(<http://www.ricoh-imaging.de>)

**RICOH IMAGING UK LTD.** PENTAX House, Heron Drive, Langley, Slough, Berks SL3 8PN, U.K.  
(<http://www.ricoh-imaging.co.uk>)

**RICOH IMAGING AMERICAS  
CORPORATION** 633 17th Street, Suite 2600, Denver, Colorado 80202, U.S.A.  
(<http://www.us.ricoh-imaging.com>)

**RICOH IMAGING CANADA  
INC.** 5520 Explorer Drive Suite 300, Mississauga, Ontario, L4W 5L1, CANADA  
(<http://www.ricoh-imaging.ca>)

**RICOH IMAGING CHINA CO.,  
LTD.** 23D, Jun Yao International Plaza, 789 Zhaojiabang Road, Xu Hui District,  
Shanghai, 200032, CHINA  
(<http://www.ricoh-imaging.com.cn>)

<http://www.ricoh-imaging.co.jp/english>

- Specifications and external dimensions are subject to change without notice.

## Free Manuals Download Website

<http://myh66.com>

<http://usermanuals.us>

<http://www.somanuals.com>

<http://www.4manuals.cc>

<http://www.manual-lib.com>

<http://www.404manual.com>

<http://www.luxmanual.com>

<http://aubethermostatmanual.com>

Golf course search by state

<http://golfingnear.com>

Email search by domain

<http://emailbydomain.com>

Auto manuals search

<http://auto.somanuals.com>

TV manuals search

<http://tv.somanuals.com>