

PENTAX



**AUTO ZOOM ELECTRONIC
FLASH UNIT**

AF-540FGZ

OPERATING MANUAL



Please read this operating manual carefully first for proper use.

Download from [Www.Somanuals.com](http://www.somanuals.com). All Manuals Search And Download.

Thank you for purchasing the PENTAX Auto-flash AF540FGZ.

In addition to easy daylight sync photography with TTL auto, the AF540FGZ also allows wireless TTL auto (P-TTL auto) photography and high-speed sync. It is a clip-on type flash which enables accurate focus adjustments even in dark locations with built-in AF-assist spotbeam.

PENTAX is a trademark of HOYA CORPORATION.

FOR THE SAFE USE OF YOUR FLASH UNIT

Although we have carefully designed this flash unit for safe operation, please be sure to follow precautions given on page 2.

WARNING

This symbol indicates that violating this item could cause serious personal injuries.

CAUTION

This symbol indicates that violating this item could cause minor or medium personal injuries, or material losses.

 is a symbol indicating items that are prohibited.

 is a symbol emphasizing a warning.



WARNING



The flash contains electronic circuits that operate at high voltages. Do not attempt to disassemble the flash unit yourself, as there is danger of an electric shock.



If internal parts of the flash unit becomes exposed due to impact, etc., do not touch them as there is danger of an electric shock.



Do not expose the flash unit to water or moisture as there is danger of an electric shock.



CAUTION



Do not use the flash near anyone's eyes, as it may hurt them. Be particularly careful with the flash around infants.



The following may lead to an explosion or fire.

- Shorting the batteries
- Exposing the batteries to flames
- Dismantling the batteries
- Remove the sticker covering the battery.
- Attempting to recharge non-rechargeable batteries



Remove the batteries from the camera immediately if they become hot or begin to smoke. Be careful not to burn yourself during removal.

Precautions for Your Flash Unit

- Never use organic solvents such as paint thinner, alcohol or benzene to clean the flash unit.
- Avoid leaving the flash unit for extended period in places where the humidity and temperature are very high such as in a car.
- Be careful not to subject the flash unit to strong vibrations, shock or pressure. Use a cushion to protect the flash unit when carrying it in a motorcycle, car, boat, etc.
- Do not use the flash unit where it may be directly exposed to rain, water, etc.
- Replace all the batteries at the same time. Do not mix battery brands, type or an old battery with a new one. It may cause explosion or overheating.
- When using the flash unit off the camera, do not try to attach any metallic object to the electric contacts or to mount incompatible accessories. Otherwise, the TTL auto mechanism may be damaged or rendered inoperable.
- Periodic checks are recommended every 1 to 2 years in order to maintain high performance. If the unit has not been used for an extended period of time, or is being readied for an important shoot, it is recommended that you take a test flash with the test button and test shoot with it. Test flash is also important to maintain optimum performance.
- Avoid contact with garbage, dirt, sand, dust, water, toxic gases, salt, etc. When the flash unit is subjected to rain or moisture, wipe it off with a dry soft.
- When photographing black subjects or white subjects, use exposure compensation.
- Do not attach any accessories having either fewer or different (layout other than PENTAX standard) electrical contacts for the hot shoe or grip. Otherwise, some functions may not work properly.
- We will not be held responsible for any accidents or damage, etc. caused due to the use of this product with cameras and accessories made by the other companies.

■ Cautions Regarding Batteries

- This flash unit uses four AA alkaline, lithium, or nickel metal hydride batteries. Do not use any other type of battery. The flash unit may not be able to operate correctly or demonstrate sufficient performance, or the flash unit itself may generate heat, depending on the type of batteries used.
- AA alkaline and lithium batteries themselves are not rechargeable. Also, do not dismantle the batteries. Trying to recharge or dismantle these batteries may cause an explosion or leakage.
- When changing batteries, do not mix batteries of different manufacture, type and capacity.
- Do not insert the batteries with the positive (+) and negative (-) terminals the wrong way around. Incorrect insertion may lead to an explosion or fire.
- Battery performance may temporarily be hindered in low temperatures. Batteries should be kept warm in temperatures below freezing for proper performance.
- If you do not intend to use the flash unit for an extended period of time, remove the batteries. Leaving the batteries in may cause damage to the flash unit due to leakage etc.

Contents

FOR THE SAFE USE OF YOUR FLASH

UNIT	1
Precautions for Your Flash Unit	3
Cautions Regarding Batteries	4
Names of Parts	6
Major bundled items	9
LCD Panel Indicator	10
Inserting the Batteries	12
Using the Optional External Power Source	13
Mounting to Camera	14
Turning the Power On	15
Charging the AF540FGZ with the Optional External Power Source	16
Switching the Charging Mode	16
Auto Power Off Function	17
Quick Power On Function	17
Select Button (S)/Adjustment	
Dial Functions	18
Procedure	18
Camera Format and Flash	
Coverage Angle	20
Using the Flash Modes	25
P-TTL Auto Flash	26
TTL Auto Flash	27
Auto Flash	28
Manual Flash	30
Using the Sync Mode	32
Leading Curtain Sync Mode	33
Trailing Curtain Sync Mode	33

High-Speed Sync Mode	34
Contrast Control Sync Flash	36
Advanced Functions	38
Wireless Mode	38
Slave	50
Slave Mode Setting	52
Slow-Speed Sync Photography	53
Bounce Flash	54
AF Spotbeam	56
Wide-Angle Panel and Catchlight Panel	57
Modeling Flash/Test Flash	58
Connecting the AF540FGZ with the Extension Cord	59
Supported Functions for PENTAX	
Cameras	60
Cameras that Support Each Flash Mode	60
Cameras that Support Each Sync Mode	62
Cameras that Support Wireless Mode	63
Cameras that Support Slow-Speed Sync Mode	64
Functions Related to Each Flash Mode	64
Sync Mode Restrictions	72
Precautions When Photographing with a Slave Flash	79
Flash Effective Range	80
Calculating the Flash Effective Range	80
Guide Number (GN)	82
P-TTL and TTL Auto Flash Effective Range	85
Optional Accessories	87
Specifications	88
Warranty Policy	91

Names of Parts

- ① Bounce angle adjustment
- ② LCD panel
- ③ Flash mode button
- ④ Select button
- ⑤ Adjustment dial
- ⑥ LCD panel illumination button/ Format button
- ⑦ Zoom button/ Channel button
- ⑧ Test button/ Modeling button/ Ready lamp
- ⑨ Setting switch
- ⑩ Power switch
- ⑪ Wireless mode button
- ⑫ Sync mode switch
- ⑬ Bounce lock release button
- ⑭ Battery chamber cover
- ⑮ Shoe lock pin
- ⑯ Flash signal contacts
- ⑰ Shoe foot
- ⑱ Locking lever

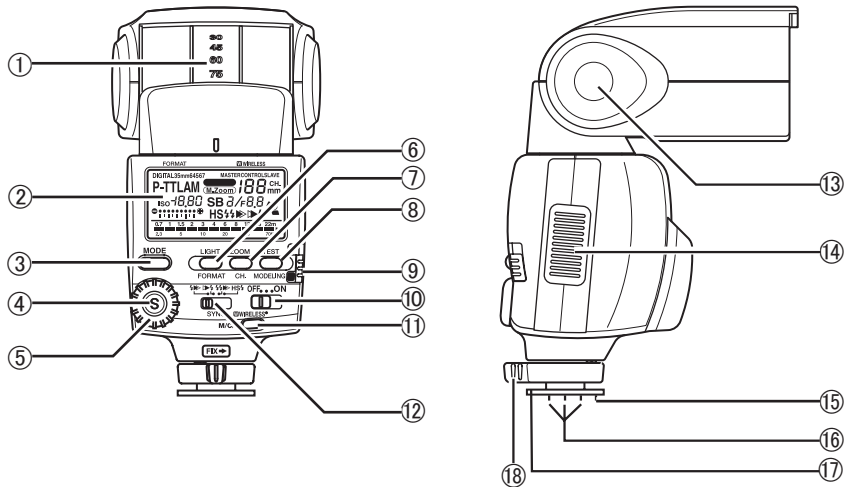

- ⑲ 5P Sync socket
- ⑳ External power source socket
- ㉑ Socket cover
- ㉒ Slave sensor
- ㉓ Wide-angle panel
- ㉔ Catchlight panel
- ㉕ Flash head
- ㉖ AF spotbeam emitter
- ㉗ Auto flash sensor

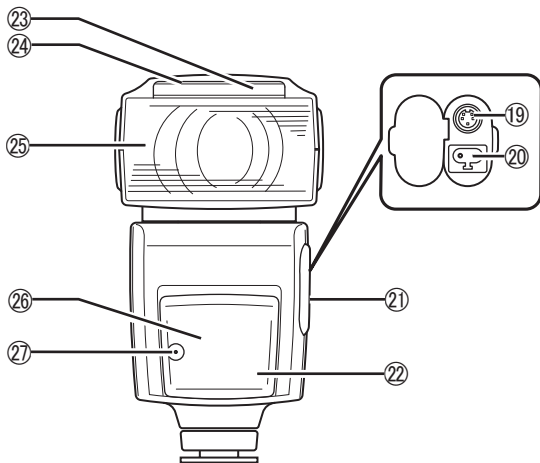

■ Major bundled items

① Stand

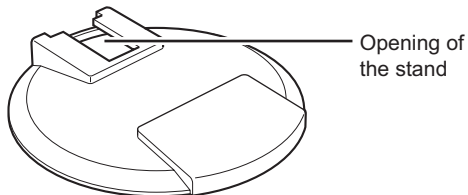

Opening of
the stand

② Case





③ Operating manual (this manual)

④ Certification

Slide the hot shoe bracket into the opening of the stand.

- You cannot attach the off-camera shoe adapter F to the bundled stand.
- When attaching the flash unit to the stand, do not tighten the locking lever too far. Tightening too far may cause the locking lever to not lock sufficiently when the flash unit is removed from the stand and attached to the hot shoe of the camera.

■ LCD Panel Indicator

- ① Zoom indicator : A.Zoom → M.Zoom xmm = 20, 24, 28, 35, 50, 70, 85 (35 mm format)
35, 45, 55, 70, 100, 135, 150 (645 format)
55, 60, 70, 90, 120, 180, 190 (67 format)
13, 16, 19, 24, 34, 48, 58 (DIGITAL camera
(K series, *ist D series))
25, 30, 35, 43, 62, 87, 106 (645D)
- ② Format indicator : 35mm → 645 → 67 → DIGITAL
- ③ Flash mode indicator : P-TTL → A → M → SB
- ④ Flash output compensation indicator : -3.0 to +1.0 steps, 0.5 step increments
- ⑤ ISO indicator : ISO 25 to 1600
- ⑥ Bar graph
- ⑦ Effective flash range indicator : Minimum distance - Maximum distance (in P-TTL, TTL, A modes)
Minimum distance (in manual mode)
- ⑧ AF spotbeam : SB
- ⑨ Sync mode indicator :  (Leading curtain sync) -  (Trailing curtain sync) -  (Contrast control sync) - **HS** (High-speed sync)
- ⑩ Bounce flash warning : 
- ⑪ Flash output adjustment indicator : ○ ○ / X X
f/stop : F2 to F22 (When set to ISO 100)
- ⑫ Channel indicator : 1 to 4CH
- ⑬ Wireless mode indicator : MASTER, CONTROL, SLAVE

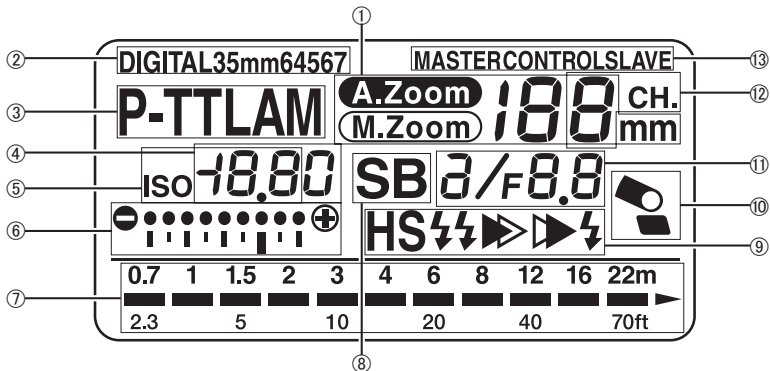

When in poorly lit locations and the LCD panel cannot be seen, pressing the LCD panel illumination button (LIGHT) will illuminate the panel for about 10 seconds. Pressing it again will turn off the illumination.

- **The camera's LCD panel lights up also when you press the LCD illumination button (LIGHT) and the exposure metering timer is on for the following camera.**
MZ-S

Auto Check Display

If the correct flash output is obtained, the flash mode indicator and (⚡) in the viewfinder will begin blinking. If the auto check display does not blink, the flash output is insufficient. Verify the effective flash range (refer to page 80) and adjust the distance to the subject, or open the aperture further.

Even if the auto check display is blinking, the flash output may be incorrect if the subject is too close.

- **Depending on the combination of flash mode and camera, the auto check display may not display correctly**

Inserting the Batteries

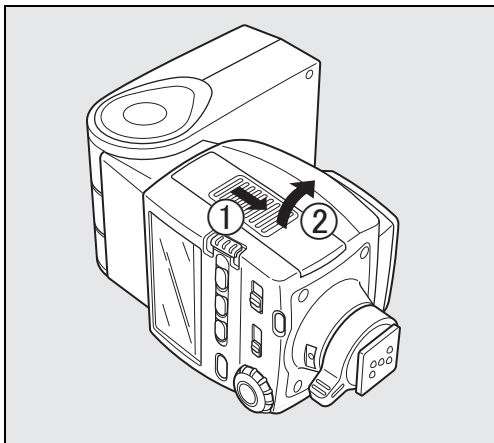

- 1** Slide the battery chamber cover as shown in the figure to open.

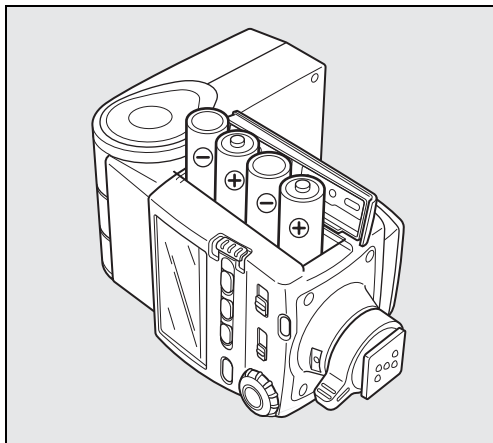

- 2** Insert four AA batteries, making sure the plus/minus markings (\oplus , \ominus) match the diagram inside the battery chamber cover.

Types of Batteries

This flash unit uses four AA batteries of the same type, as shown below.

- Alkaline battery (LR6)
- Lithium battery (FR6)
- Nickel-Metal Hydride battery (Ni-MH)
(Nickel manganese (Ni-Mn) and nickel cadmium (Ni-Cd) batteries cannot be used.)
- **For information about recycling times and total number of flashes, refer to “Specifications” on page 88.**
- **If the indicators on the LCD panel or the ready lamp does not light up, the batteries may be exhausted or not inserted correctly. Verify the orientation of the batteries or, if the indicators and ready lamp still do not light up, replace them with new batteries.**
- **If you let the flash unit discharge successively using lithium batteries, the batteries will overheat, activating a safety circuit that temporarily disables the flash unit. If this occurs, rest the flash unit so that the temperature of the batteries returns to normal.**

■ Using the Optional External Power Source

Use the optional TR Power Pack-3 (sold separately) as an external power source.

- **For information on how to use the TR Power Pack-3 and connect to the flash unit, refer to the manual provided with the TR Power Pack-3.**
- **For information on how to recharge the flash unit using the TR Power Pack-3, refer to “Charging the AF540FGZ with the Optional External Power Source” on page 16.**
- **The TR Power Pack-2 cannot be used with the AF540FGZ for mechanical reasons.**

The external power source uses six C-size alkaline batteries (LR14).

(Nickel cadmium (Ni-Cd) batteries cannot be used in the TR Power Pack-3.)

Mounting to Camera

1

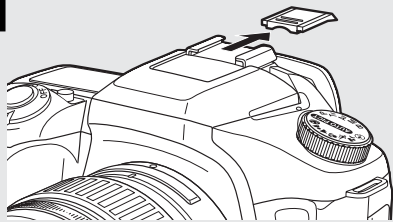

1 Remove the hot shoe cover from the camera.

2 Attach the flash unit to the camera.

- ① Turn the locking lever of the flash unit in the direction opposite to that indicated by (FIX→) (clockwise from the direction of the LCD panel).
- ② Slide the hot shoe foot of the flash unit into the camera's hot shoe from the back of the camera forward.
- ③ Turn the locking lever of the flash unit in the direction indicated by (FIX→) to lock it.

2

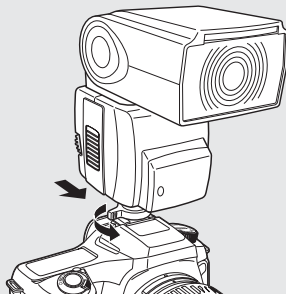

- The following cameras have a shoe lock pin. When attaching the flash unit, turn the locking lever in the (FIX→) direction and lock the flash unit to the camera with the shoe lock pin. When releasing the flash unit, be sure to do so after turning the locking lever in the direction opposite to that indicated by (FIX→) and loosening the shoe lock pin. Otherwise, the hot shoe will be damaged. 645D, K-x, K-7, K-m/K2000, K20D, K10D, K200D, K110D, K100D Super, K100D, *ist D series, *ist, MZ-S, MZ-L/ZX-L/MZ-6, MZ-60/ZX-60
- The 67 II does not come with a hot shoe. The optional hot shoe grip 67 II should be used.

Turning the Power On

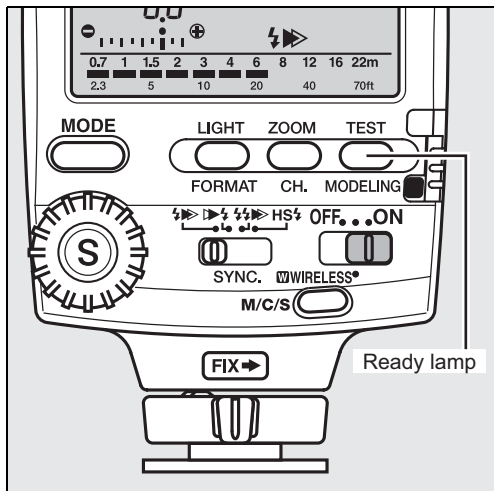

Sliding the power switch to the (ON) position will turn on the power. The ready lamp will light up when the flash is charged. Sliding it to the (OFF) position will turn off the power.

If charging time takes more than 20 seconds, the batteries have been exhausted and should be replaced with new batteries. If the flash unit is used with exhausted batteries, the settings may return to their default configuration.

- Turn the camera on before turning the flash unit on.
- The WIRELESS position of the power switch is used for wireless mode and slave flash. For details, see the explanations for each function.
 - Wireless mode (page 38 - 49)
 - Slave flash (page 50 - 51)

■ Charging the AF540FGZ with the Optional External Power Source

- 1** Prepare the external power source TR Power Pack-3 in accordance with the instruction in the operating manual.
- 2** Confirm that the power switch of the flash unit and TR Power Pack-3 is turned to OFF. Then, plug the power cord into the external power socket on the flash unit.
- 3** Turn the power switch of the external power source and the power switch of the flash unit to ON. When charging is complete the ready lamp of the flash unit will light up.

When using the external power source, do not remove the batteries from the AF 540 FGZ: otherwise, the flash unit will not function.

- The TR Power Pack-3 is equipped with a pilot lamp which lights up to indicate that the power is activated. Note that a lit lamp does not indicate that the flash unit is ready for use. Make sure the ready lamp on the flash unit is lit before discharging the flash unit.

- When turning off the flash unit, make sure you turn the power switch of the external power source to OFF. Otherwise the external power source may be exhausted.

■ Switching the Charging Mode

You can select a charging mode from among the following.

- PP1: Charge the flash unit using only the external power source.
- PP2: Charge the flash unit using the external power source and internal batteries. (Enables high speed charging with a charging interval of approximately 2 seconds.)

- 1** Slide the setting switch up.
- 2** Press the LCD panel illumination button (LIGHT) for 2 seconds or more. SL 1 or SL 2 will be displayed.
- 3** Press the flash mode button (MODE) twice. PP1 or PP2 will be displayed.
- 4** Press the select button (S) the number of times required to select PP 1 or PP 2.
- 5** Press the LCD panel illumination button (LIGHT). The LCD panel returns to the normal display.

■ Auto Power Off Function

When the flash unit is left unused for about 3 minutes with the power switch set to the (ON) position, it automatically switches off to save the power.

- 1** Slide the setting switch up.
- 2** Press the LCD panel illumination button (LIGHT) for 2 seconds or more.
SL 1 or SL 2 will be displayed.
- 3** Press the flash mode button (MODE).
- 4** Press the select button (S) the number of times required to select PH 1 or PH 2.
PH1: Enables the auto power off function.
PH2: Disables the auto power off function.
- 5** Press the LCD panel illumination button (LIGHT).

- **The Auto Power Off function can be utilized both when only internal batteries are used and when an external power source is used.**
- **In the auto flash mode (A), the power will shut off after about 6 minutes.**
- **In the wireless mode, the power will turn off after about 1 hour of non-operation.**

■ Quick Power On Function

If the flash unit is mounted on autofocus cameras, press the shutter release button half way to turn on the power.

- **The Quick Power On function can be utilized both when only internal batteries are used and when an external power source is used.**

Select Button (S)/Adjustment Dial Functions

4 types of settings are available as shown on the following pages for the select button (S) and the adjustment dial.

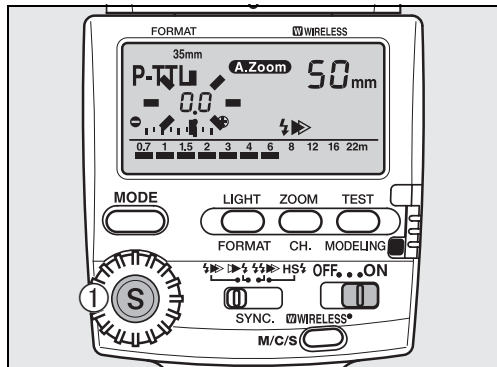

■ Procedure

- 1** Press the select button (S) so that the number to adjust is blinking.

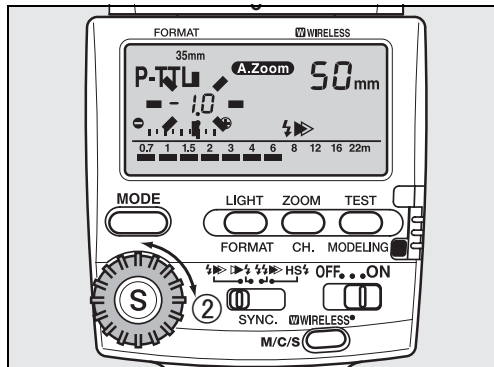

- 2** Turn the adjustment dial and adjust the blinking number.

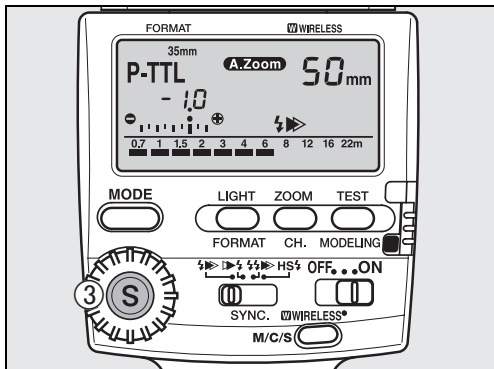

3 After adjustment, press the select button (S) and stop the blinking. Adjust the other items below using the same procedure.

- **When using multiple flash units set to P-TTL or TTL Auto and adjusting the amount of light at the same time, use the camera's exposure compensation.**

	Connected Flash Mode	Adjustment Range
Flash output compensation	P-TTL Auto flash	-3.0 to +1.0 levels (EV) (0.5 step increments)
ISO / F (aperture) setting	Auto flash (A)	ISO 25 to ISO 1600, F2 to F22 (with ISO100)
Manual flash output	Manual (M)	1/1, 1/2, 1/4, 1/8, 1/16, 1/32, 1/64
Flash output setting	Wireless (W) master flash (M) Wireless (W) slave flash (S)	1/1, 2/3, 1/2, 1/3

Camera Format and Flash Coverage Angle

The AF540FGZ's flash coverage angle can be adjusted to match the angle of view of the lens being used, which enables effective distribution of the flash light. The flash coverage angle is indicated by the focal lengths of available lenses in the LCD panel of the flash unit, according to the preset image size (FORMAT) of the camera.

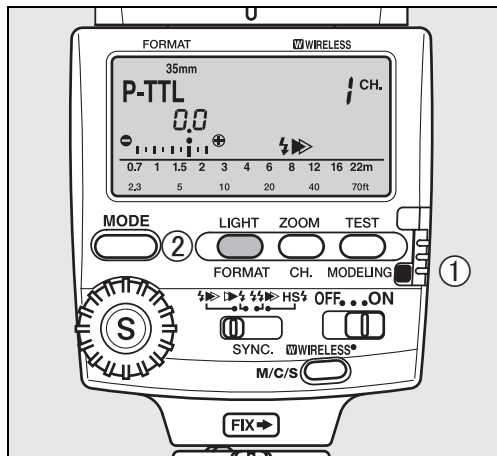

1 ■ Format setting

Firstly, set the FORMAT to match the image size of the camera you are using.

The format size will automatically be set when the shutter release button is pressed halfway down when the AF540FGZ is used in combination with the following cameras.

645D, K-x, K-7, K-m/K2000, K20D, K200D, K100D Super, K10D, K110D, K100D, *ist DL2, *ist DS2, *ist DL, *ist DS, *ist D, *ist, MZ-L/ZX-L/MZ-6, MZ-S

For other cameras, before use, set the FORMAT to match the image size of the camera according to the following procedure.

- ① Slide the setting switch down (yellow dot).
- ② Press the FORMAT button repeatedly to display camera formats (image sizes) in the LCD panel.

You can switch from 35mm → 645 → 67 → DIGITAL → 35mm in that order.

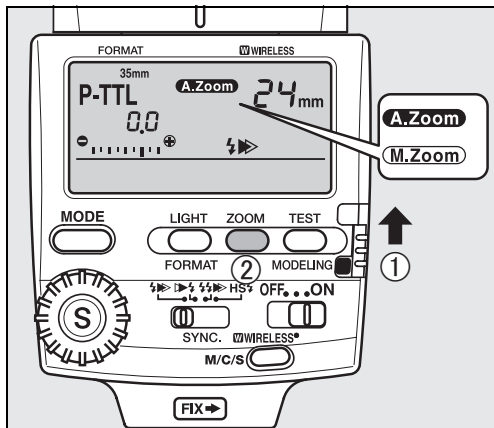

2 ■ Zoom position (Flash coverage angle) setting

Next, set the zoom (flash coverage angle) to match the focal length of the lens you are using.

■ Auto Zoom (A.Zoom)

If both the camera and lens are autofocus, you can automatically set the flash coverage angle according to

the focal length of the lens by pressing the shutter release button of the camera halfway down. The auto zoom function operates while the exposure metering timer is operating (while information is being displayed in the viewfinder).

- ① If you are setting the format manually, return the setting switch to the upper (white dot) position.
 - ② When (M.Zoom) is displayed on the LCD panel, press the zoom button (ZOOM) repeatedly until (A.Zoom) is displayed.
- **When the flash mode is set to auto flash, the auto zoom function does not operate even if the camera and lens are both autofocus. Set the zoom manually to match the lens angle of view.**

■ Manual Zoom (M.Zoom)

If one or both of the camera and lens are manual focus, you must set the flash coverage angle manually.

- ① If you are setting the format manually, return the setting switch to the upper (white dot) position.
- ② Press the zoom button (ZOOM) until the focal length of the lens being used is displayed on the LCD panel or if it can not be displayed exactly one wider than the lens focal length. The zoom position is switched in the order shown in the diagram on page 23.

- In the manual zoom mode, refer to the LCD panel and set it so the flash coverage angle matches the lens focal length or set a flash coverage angle that is shorter than the lens focal length.

Zoom Positions for Each Format

* With the wide-angle panel

35mm camera	645 camera	67 camera	Digital camera (K series, *ist D series)	Digital camera (645D)
20mm*	35mm*	55mm*	13mm*	25mm*
24mm	45mm	60mm	16mm	30mm
28mm	55mm	70mm	19mm	35mm
35mm	70mm	90mm	24mm	43mm
50mm	100mm	120mm	34mm	62mm
70mm	135mm	180mm	48mm	87mm
85mm	150mm	190mm	58mm	106mm

- When the wide-angle panel is used, the zoom button (ZOOM) will not work. (The wide-angle panel is in a slit on the top of the flash head. Pull it out so that it covers the front of the flash head. If the catchlight panel is not necessary, leave it in the slit.)

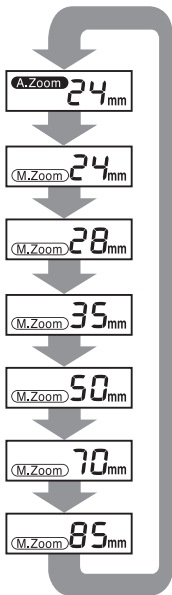

35mm Camera

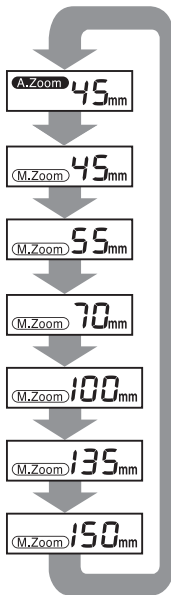

645 Camera

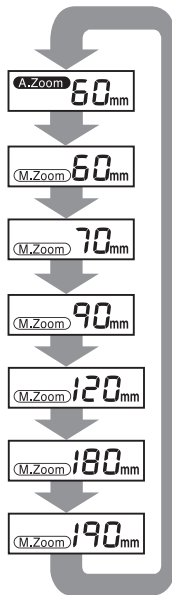

67 Camera

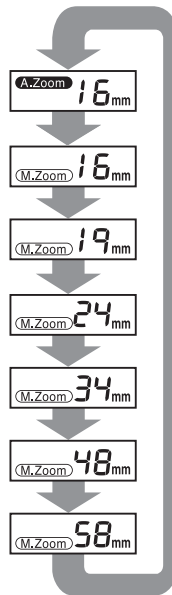

Digital Camera
(K series, *ist D series)

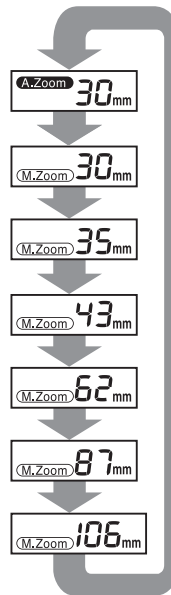

Digital Camera
(645D)

- In the (A.Zoom) mode, the flash coverage angle will be adjusted automatically to suit the lens focal length when you press the shutter release button halfway, and the camera exposure metering timer is on.
- A warning signal appears as follows when the flash cannot cover the focal length of the camera.
 - The zoom indicator blinks for the combination of the following camera and lenses.

Camera	Lens Types
*ist D series	DA, D FA, FA J, FA, F
35mm autofocus single lens reflex cameras	D FA, FA J, FA, F
645N II, 645N	FA645

- The warning signal does not appear for the combination of the following cameras and focal lengths.

Camera	Focal length
*ist, MZ-L/ZX-L/MZ-6, MZ-S	20 mm and over, less than 24 mm
*ist DL, *ist DS, *ist D	13 mm and over, less than 16 mm

- In the (A.Zoom) mode, if there is no lens focal length information, the flash coverage angle will be set automatically to 24mm with a 35mm camera. With a 645 camera, it will be set to 45mm, with a 67 camera it will be 60mm, with a digital camera (K series, *ist D series) it will be 16 mm, and with a digital camera (645D) it will be 30mm.
- When using the wide-angle panel, the angle will be fixed at 20 mm for a 35 mm camera, 35 mm for a 645 camera, 55 mm for a 67 camera, 13 mm for a digital camera (K series, *ist D series), and 25mm for a digital camera (645D) in both A.Zoom and M.Zoom.

Using the Flash Modes

The AF540FGZ has the following flash modes. Select the mode best suited for the subject.

Before photographing, confirm the following.

1. Whether your camera supports the desired flash mode.

→ **Cameras that Support Each Flash Mode**
(page 60)

2. Whether you can use the desired function with the combination of your camera and the flash mode you have set.

→ **Functions Related to Each Flash Mode**
(page 64 - 71)

P-TTL auto flash (P-TTL)

A pre-flash is discharged before the main flash so that the multi-segment metering sensor can measure the subject's distance, brightness, brightness difference, backlit condition, etc. The data obtained is incorporated to set the output of the main flash. This mode obtains more accurate results than with the conventional TTL mode. Refer to page 26 for instructions on how to use this flash mode.

TTL auto flash (TTL)

Based on the amount of light reflected off the film of the camera, the camera adjusts the flash output automatically to obtain a correct exposure. Refer to page 27 for instructions on how to use this flash mode.

Auto flash (A)

The built-in flash metering sensor adjusts the flash output automatically. Use with cameras that are not P-TTL or TTL Auto flash compatible. Refer to page 28 for instructions on how to use this flash mode.

Manual flash (M)

When the camera is set to manual exposure, manual flash can be set to suit the subject distance and aperture. The manual flash output can be set to 1/1, 1/2, 1/4, 1/8, 1/16, 1/32, or 1/64. Refer to page 30 for instructions on how to use this flash mode.

■ P-TTL Auto Flash

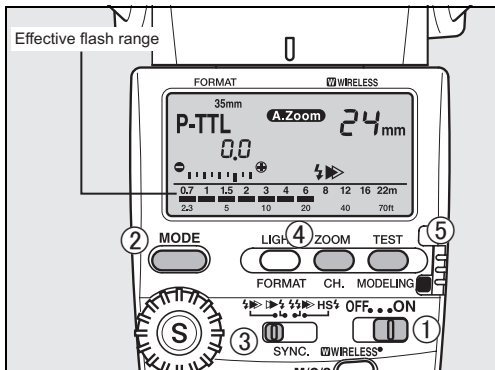

Refer to page 25 for the features and conditions of use of this flash mode.

Procedure

1

Turn on the flash unit.

2

Press the flash mode button (MODE) until (P-TTL) is displayed on the LCD panel.

3

Set the sync mode switch to leading curtain sync (⚡▶), trailing curtain sync (▶⚡), or contrast-control (⚡▶▶), according to the subject. (Refer to page 32.)

● After turning the power (ON), the setting will be (P-TTL) and (A.Zoom).

4

Set the zoom position. (The setting method differs according to your camera and lens. Refer to page 21.)

5

Confirm that the subject is within the effective flash range and the ready lamp is lit. Then take a picture.

● In the following cameras, if the correct flash output is obtained, the flash mode indicator and (⚡) in the viewfinder will blink.

*ist, MZ-S, MZ-L/ZX-L/MZ-6

For details, refer to “Auto Check Display” on page 11.

● The correct flash output is obtained in P-TTL auto mode only when the flash unit is used with autofocus lenses.

● If necessary, an exposure compensation amount can be set between +1.0 to -3.0 steps in 0.5-step increments. (Refer to page 18.)

■ TTL Auto Flash

Refer to page 25 for the features and conditions of use of this flash mode.

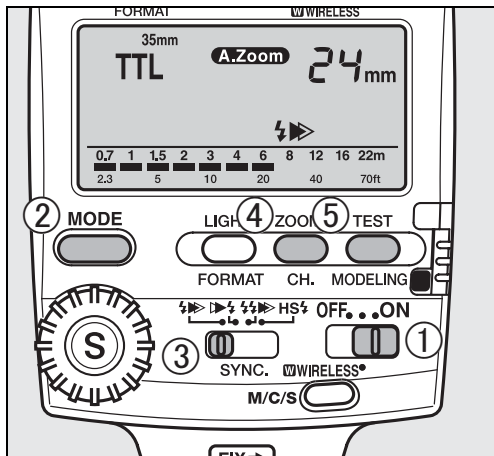

Procedure

- 1 Turn on the flash unit.
 - 2 Press the flash mode button (MODE) until (TTL) is displayed on the LCD panel.
 - 3 Set the sync mode switch to leading curtain sync (⚡▶▶), trailing curtain sync (▶▶⚡), or contrast-control (⚡▶▶▶), according to the subject. (Refer to page 32.)
 - 4 Set the zoom position. (The setting method differs according to your camera and lens. Refer to page 21.)
 - 5 Confirm that the subject is within the effective flash range and the ready lamp is lit. Then take a picture.
- In the following cameras, if the correct flash output is obtained, the flash mode indicator and (⚡) in the viewfinder will blink.
35 mm single lens reflex cameras except for SF7/ SF10, 67 II, 645N II, 645N, 645, LX, Super A/ Super Program
For details, refer to “Auto Check Display” on page 11.

■ Auto Flash

Refer to page 25 for the features and conditions of use of this flash mode.

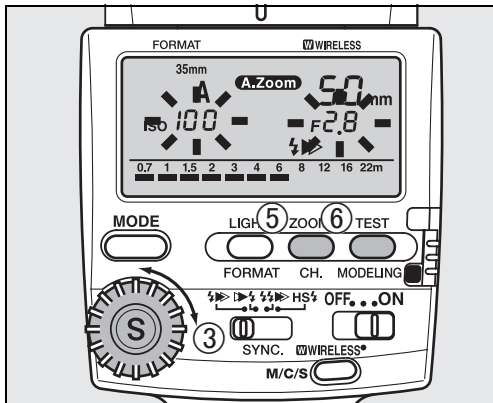
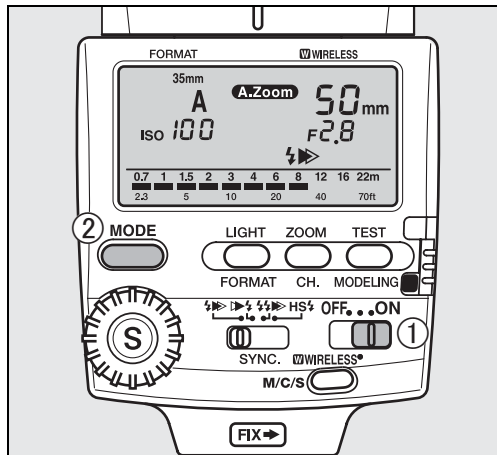

Procedure

- 1** Turn on the power switch.
- 2** Press the flash mode button (MODE) until (A) is displayed on the LCD panel.
- 3** Set the aperture value and ISO.
 - ① Press the select button (S) so that (f/stop) on the LCD panel blinks.
 - ② Turn the adjustment dial to set the aperture value.
 - **The effective flash range is displayed on the LCD panel bar graph.**
 - ③ Confirm that the subject is within the effective flash range and press the select button (S).
 - ④ Turn the adjustment dial to set the ISO after (ISO) starts blinking.
 - ⑤ Press the select button (S). The setting is complete if (ISO) stops blinking.
- 4** Set the lens aperture to the same aperture value as that set on the LCD panel.
 - **The camera's aperture value is synchronized with that of the flash unit when the camera exposure mode is set to Programmed AE or Shutter Priority AE.**

- 5** Set the zoom position. (The setting method differs according to your camera and lens. Refer to page 21.)
 - **Select (M.Zoom) regardless of the type of lens being used.**
- 6** Confirm that the subject is within the effective flash range and the ready lamp is lit. Then take a picture.
 - **In the following cameras, if the correct flash output is obtained, the flash mode indicator and (⚡) in the viewfinder will blink.**
645, LX, Super A/Super Program, MZ-M/ZX-M, P30T, P30N/P3N, P30/P3, P50/P5, A3Date, A3DateS, Program A/Program Plus
For details, refer to "Auto Check Display" on page 11.
 - **If the power is turned temporarily OFF, the flash will be set to P-TTL or TTL auto. Return the setting to Auto flash.**
 - **The sync mode will be fixed in leading curtain sync.**

Manual Flash

Refer to page 25 for the features and conditions of use of this flash mode.

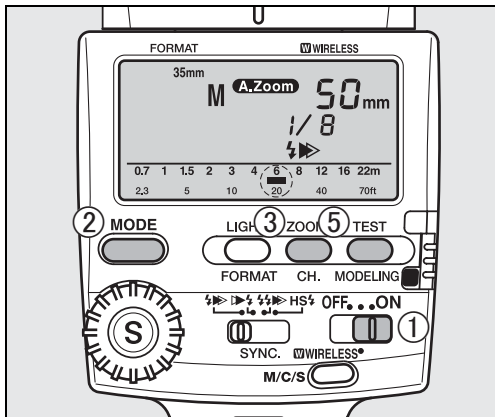

Procedure

- 1 Turn on the power switch.
- 2 Press the flash mode button (MODE) to display (M) (1/xx) on the LCD panel.
 - You can set the flash output from 1/1 to 1/64. See page 18.
- 3 Set the zoom position. (The setting method differs according to your camera and lens. Refer to page 21.)
- 4 Set the lens aperture according to the distance to the subject.

Example:

If the flash zoom position is 50mm, subject distance (between the AF540FGZ and subject) is 4 m, and sensitivity is ISO 100, the calculation will be as follows:

- ① With flash output (1/1), the Guide No. will be 45 (according to the Guide No. table).
- ② Aperture = Guide No. 45 / Subject distance 4 m = 11.25 ≈ Approx. 11 (f/Stop)

- Refer to page 82 for the guide number table.

5 Confirm that the subject is within the effective flash range and the ready lamp is lit. Then take a picture.

- **In the following cameras, if the correct flash output is obtained, the flash mode indicator and (⚡) in the viewfinder will blink.**

645, LX, MZ-M/ZX-M

For details, refer to “Auto Check Display” on page 11.

Using the Sync Mode

The AF540FGZ has the following sync modes. Select the mode best suited for the subject.

Before photographing, confirm the following.

1. Whether your camera supports the desired sync mode.

→ **Cameras that Support Each Sync Mode**
(page 62)

2. Whether you can use the desired sync mode with the combination of your camera and the flash mode you have set.

→ **Functions Related to Each Flash Mode**
(page 64 - 71)

3. Restrictions for the use of each sync mode.

→ **Sync Mode Restrictions** (page 72 - 76)

Leading Curtain Sync Mode

This is the most commonly used sync mode. In this mode, the flash discharges at the instant the first shutter curtain completes its travel. You can use this mode with the shutter speed set to the X-sync speed or slower. Refer to page 33 for instructions on how to use this sync mode.

Trailing Curtain Sync Mode

In this sync mode, the flash is discharged at the instant the second curtain begins its travel. This mode will freeze the subject with a blur appearing after the subject under a slow shutter speed condition. Refer to page 33 for instructions on how to use this sync mode.

High-Speed Sync Mode

This sync mode will enable flash synchronization with shutter speeds faster than the X-sync speed. Since there is no sync speed limitation, high-speed sync is effective for fill-flash in daylight. Refer to page 34 for instructions on how to use this sync mode.

Contrast Control Sync Mode

This sync mode enables you to photograph with multiple flash units, utilizing the difference of the light intensity of each flash unit. The ratio of flash light intensity between the flash unit set to this sync mode and the other flash unit is 1:2. Refer to page 36 for instructions on how to use this sync mode.

■Leading Curtain Sync Mode

Refer to page 32 for the features and conditions of use of this sync mode.

Procedure

- 1** Set the power switch to the (ON) position.
- 2** Set the sync mode switch to leading curtain sync (⚡▶▶).
- 3** Confirm that the subject is within the effective flash range and the ready lamp is lit. Then take a picture.

■Trailing Curtain Sync Mode

Refer to page 32 for the features and conditions of use of this sync mode.



Procedure

- 1** Set the power switch to the (ON) position.
- 2** Set the sync mode switch to trailing curtain sync (▶▶⚡).
- 3** Confirm that the subject is within the effective flash range and the ready lamp is lit. Then take a picture.
 - **The flash unit will switch to the trailing curtain sync mode when the shutter release button is pressed halfway down.**

■ High-Speed Sync Mode

Refer to page 32 for the features and conditions of use of this sync mode.

- As can be seen in the table on page 84, as the shutter speed becomes faster, the guide number becomes smaller. Accordingly, it should be noted that the distance for taking pictures would become shorter.

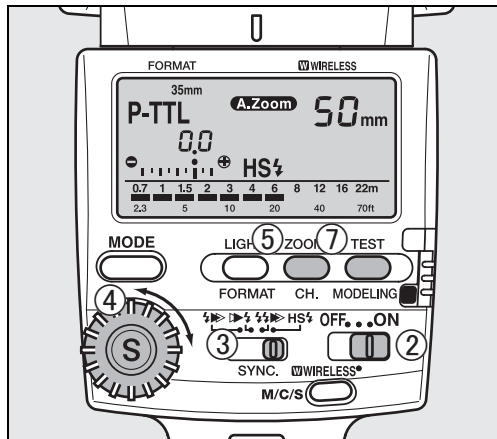

Procedure

- 1 Turn on the camera. Set the exposure mode to a mode other than the Programmed AE.
 - 2 Attach the flash unit to the camera's hot shoe and turn it on.
 - 3 Set the sync mode switch to high-speed sync (HS ζ).
- The flash will be set to high-speed sync mode and (HS ζ) will be shown on the LCD panel only when the shutter speed exceeds X-sync speed.
- 4 To set exposure compensation, press the select button (S) so that (0.0) blinks. Then turn the adjustment dial to set the exposure compensation amount. Press the select button (S) again to stop the blinking. The exposure compensation amount can be set from +1.0 to -3.0 steps in 0.5-step increments. (Refer to page 18.)
 - 5 Set the zoom position. (The setting method differs according to your camera and lens. Refer to page 21.)

6 Check the flash range by looking at the bar graph on the LCD panel.

7 Confirm that the subject is within the effective flash range and the ready lamp is lit. Then take a picture.

- **Please read the camera operating manual for camera operation.**
- **High-speed sync is possible with the camera separated (wireless) from the AF540GZ. (Refer to page 46.)**

■ Contrast Control Sync Flash

Refer to page 32 for the features and conditions of use of this sync mode.

- Refer to “Connecting the AF540FGZ with the Extension Cord” on page 59 on using the AF540FGZ detached from the camera.

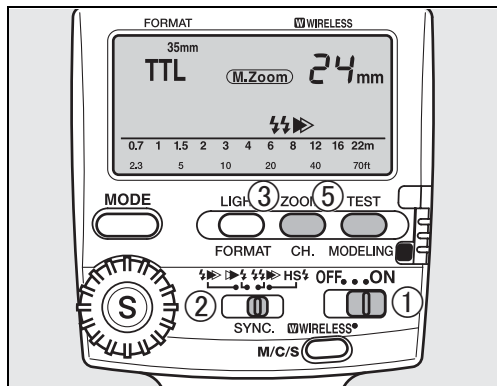

Procedure

- 1** Turn on the power switch.
- 2** Set the sync mode switch to contrast-control (⚡▶).
- 3** Set the zoom position. (The setting method differs according to your camera and lens. Refer to page 21.)
 - If the AF540FGZ is much closer to the subject than the flash unit to be used in combination, use (M.Zoom) to set the zoom position to a shorter lens focal length.
- 4** Turn on the flash units to be used in combination.
 - If the camera's built-in flash unit is part of the combination, pop up the built-in flash.
- 5** Confirm that the subject is within the effective flash range and the ready lamp is lit. Then take a picture.

With a single flash

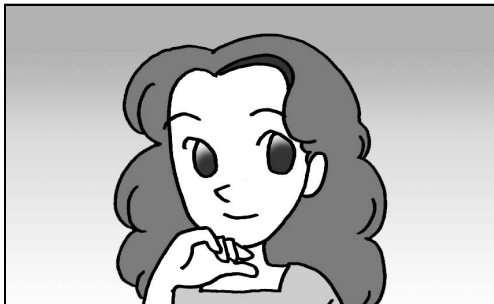

With contrast control sync flash



- If you are using a single flash unit, you can only perform leading curtain sync photography when the sync mode switch is set to contrast-control (⚡▶▶).

Advanced Functions

■ Wireless Mode

With the AF540FGZ, you can take photographs with the flash unit separated from the camera wirelessly in P-TTL mode.

Combine the flash unit with the built-in flash unit of the camera or another AF540FGZ attached to the camera.

- **The AF360FGZ can be used interchangeably with AF540FGZ flash units for wireless mode photography.**

Before photographing, confirm the following.

1. **Whether your camera supports this function.**
→ **Cameras that Support Wireless Mode** (page 63)
2. **Whether you can use this function with the combination of your camera and the flash mode you have set.**
→ **Functions Related to Each Flash Mode** (page 64 - 71)
3. **Whether the slave mode is set to SL1.**
→ **Slave Mode Setting** (page 52)

Notes on Wireless Flash Control (P-TTL photography)

When using the AF540FGZ in wireless mode, the following information is transferred between the flash units attached to the camera and separated from the camera, before the flash units are discharged.

- ① **Shutter release button is fully pressed.**
- ② **The flash attached to the camera emits a small control flash (relays the flash mode of the camera).**
- ③ **The external AF540FGZ emits a pre-flash (verifies the state of the subject).**
- ④ **The flash attached to the camera emits a small control flash (relays the flash output amount to the external AF540FGZ).**
- **The flash attached to the camera will emit a pre-flash once more after this to relay the flash duration time when HS (high-speed sync) is set.**
- ⑤ **The external AF540FGZ discharges the main flash (where both flash units discharge main flashes, refer to page 44).**

- **Control Flash and Main Flash**

The purpose of the control flash of the wireless mode is to send information to the other flash unit before taking a picture. The main flash discharges at the actual time a picture is taken in the same manner as traditionally done.

- **When setting up a flash unit separately from the camera, use the off-camera shoe adapter F when using a tripod, or the off-camera shoe clip CL-10 when setting up in another location such as tabletop, chair, etc.**
- **Keep the distance from the built-in flash unit and AF540FGZ to the subject within 4 meters.**

Using the AF540FGZ in Combination with a Built-in Flash Unit

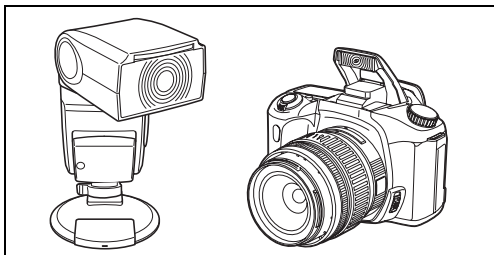

- The AF540FGZ can be used in combination with a built-in flash unit only when used with the following cameras.

*ist D, *ist, MZ-S, MZ-L/ZX-L/MZ-6, K10D (NOTE), K20D, K200D, K-x, K-7, K-m/K2000

(NOTE)

However, this requires the firmware to be updated to Version 1.10 or later. Download the firmware for the K10D from the following URL, and install it on your camera.

http://www.pentax.jp/english/support/download_digital.html

You may also contact your nearest PENTAX service center for firmware updates. (This will involve a fee.)

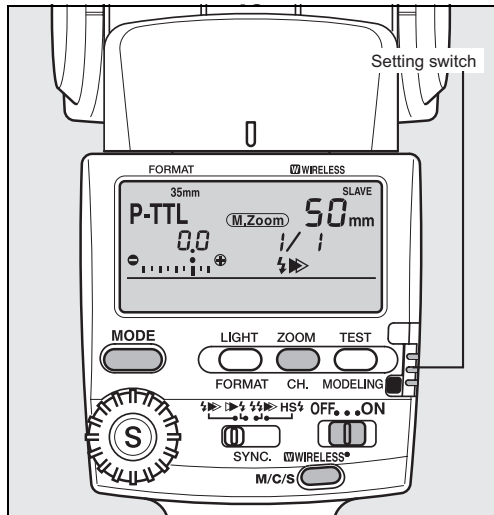

- 1** Firstly, set the wireless mode and channel of the AF540FGZ, and register them on the camera.
- ① Turn the camera off and then attach the AF540FGZ to the hot shoe of the camera.
 - ② Set the power switch of the flash unit to (WIRELESS).
 - ③ Press the wireless mode button (M/C/S) the number of times required to display SLAVE on the LCD panel.
- **You cannot set the flash unit to SLAVE while the exposure metering timer is on (while information relating to aperture etc. is displayed in the viewfinder).**
- ④ Slide down the setting switch to the (yellow dot) to display the channel on the LCD panel.
 - ⑤ Press the channel button (CH) and select a channel from 1CH to 4CH.
 - ⑥ Slide the setting switch back up to the (white dot).
 - ⑦ When you turn the camera on and press the shutter release button halfway down, the channel is registered on the camera.

- 2** Next, remove the flash unit from the camera and place it in the desired position.
- **Press the flash mode button (MODE) to display (P-TTL) if the flash mode was set to the modes other than P-TTL auto.**
- 3** Enable the built-in flash unit of the camera and set the camera flash mode to **W**(WIRELESS).
- 4** Confirm that the AF540FGZ and built-in flash unit are fully charged, and take the photograph. A lamp on the AF540FGZ will blink.
- **In the P-TTL mode, flash output setting (1/1, 2/3, 1/2, and 1/3) and flash output compensation (-3.0 to +1.0) are possible. (Refer to page 18.)**
- **The flash mode on the camera must be set to **W**(WIRELESS), otherwise the AF540FGZ will not discharge.**
- **By changing the camera's function settings, you can set the built-in flash unit so that it is not the main flash. Refer to the operating manual for the camera to find out how.**
- **For test flash, refer to page 58.**

When Attaching the AF540FGZ to the Camera for Control Flash

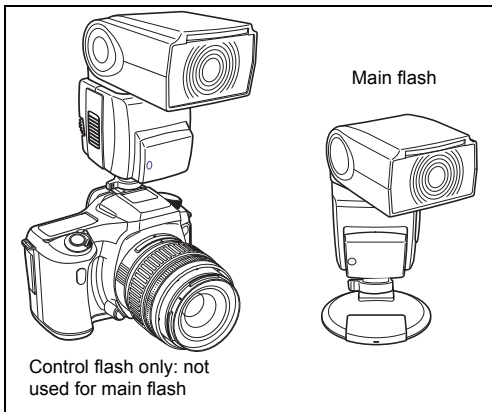

(Preparation of Flash Unit Attached to Camera)

1 Firstly, set the wireless mode and channel of the flash unit attached to the camera, and register them on the camera.

- ① Attach the AF540FGZ to the hot shoe of the camera after turning the camera off.

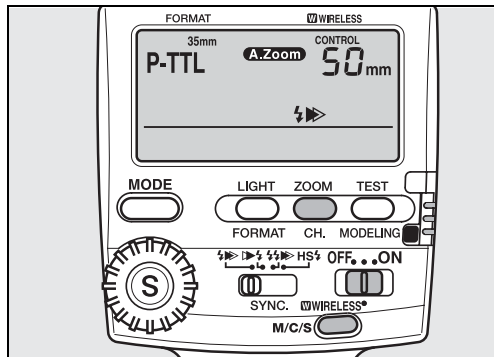

- ② Set the power switch of the flash unit to (WIRELESS).
- ③ Press the wireless mode button (M/C/S) the number of times required to display CONTROL on the LCD panel.
- ④ Slide down the setting switch to the (yellow dot) to display the channel on the LCD panel.
- ⑤ Press the channel button (CH) and select a channel from 1CH to 4CH.
- ⑥ Slide the setting switch back up to the (white dot).

- ⑦ When you turn the camera on and press the shutter release button halfway down, the channel of the flash unit is registered on the camera.

(Preparation of Separated Flash Unit)

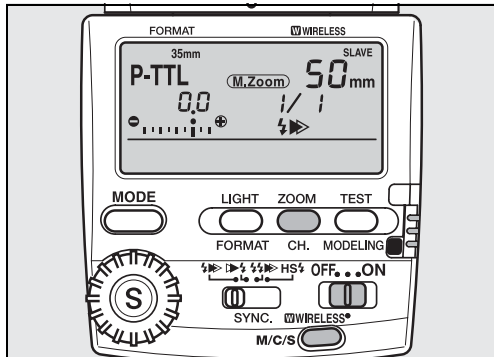

- 2** Next, set the channel of the separated (wireless) flash unit to the same channel as the flash unit attached to the camera.

- ① Place the other AF540FGZ in the desired position.
- ② Set the power switch of the flash unit to (WIRELESS).
- ③ Press the wireless mode button (M/C/S) the number of times required to display SLAVE on the LCD panel.
- ④ Slide down the setting switch to the (yellow dot) to display the channel on the LCD panel.
- ⑤ Press the channel button (CH) and select the same channel that the flash unit attached to the camera has been set to.
- ⑥ Slide the setting switch back up to the (white dot).

- **The two flash units must be set to the same channel, otherwise the separated flash unit will not discharge.**

(Photographing)

- 3** Confirm that both flash units are fully charged, and take the photograph.
A lamp on the wireless flash unit will blink.

When Using Both an AF540FGZ Attached to the Camera and a Separated Flash Unit as Main Flashes

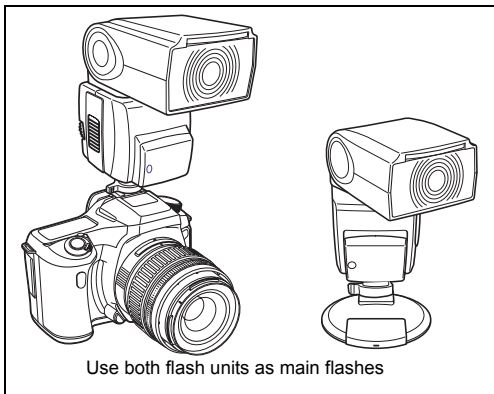

(Preparation of Flash Unit Attached to Camera)

1 Firstly, set the wireless mode and channel of the flash unit attached to the camera, and register them on the camera.

- ① Attach the AF540FGZ to the hot shoe of the camera after turning the camera off.

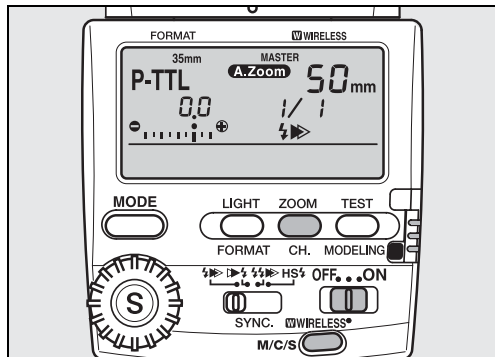

- ② Set the power switch of the flash unit to (WIRELESS).
- ③ Press the wireless mode button (M/C/S) the number of times required to display MASTER on the LCD panel.
- ④ Slide down the setting switch to the (yellow dot) to display the channel on the LCD panel.
- ⑤ Press the channel button (CH) and select a channel from 1CH to 4CH.

- ⑥ Slide the setting switch back up to the (white dot).
- ⑦ When you turn the camera on and press the shutter release button halfway down, the channel of the flash unit is registered on the camera.

(Preparation of Separated Flash Unit)

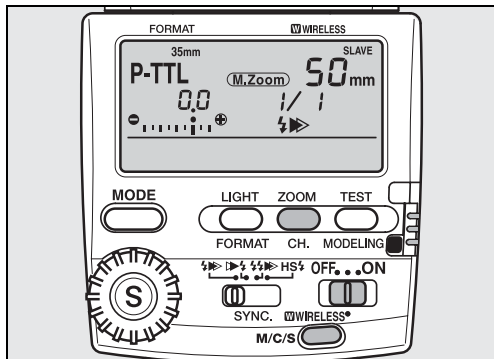

2 Next, set the channel of the separated (wireless) flash unit to the same channel as the flash unit attached to the camera.

- ① Place the other AF540FGZ in the desired position.
- ② Set the power switch of the flash unit to (WIRELESS).
- ③ Press the wireless mode button (M/C/S) the number of times required to display SLAVE on the LCD panel.
- ④ Slide down the setting switch to the (yellow dot) to display the channel on the LCD panel.
- ⑤ Press the channel button (CH) and select the same channel that the flash unit attached to the camera has been set to.
- ⑥ Slide the setting switch back up to the (white dot).

● **The two flash units must be set to the same channel, otherwise the separated flash unit will not discharge.**

(Photographing)

3 Confirm that both flash units are fully charged, and take the photograph. A lamp on the wireless flash unit will blink.

Wireless High-Speed Sync Photography

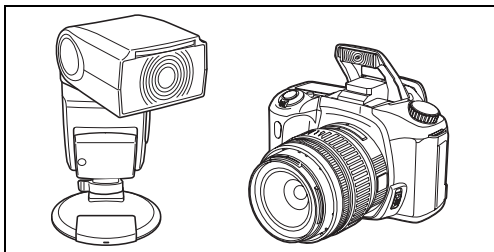

(Using the AF540FGZ in Combination with a Built-in Flash Unit)

- 1 Firstly, set the wireless mode and channel of the AF540FGZ, and register them on the camera.
 - ① Turn the camera off and then attach the AF540FGZ to the hot shoe of the camera.
 - ② Set the power switch of the flash unit to (WIRELESS).
 - ③ Press the wireless mode button (M/C/S) the number of times required to display SLAVE on the LCD panel.

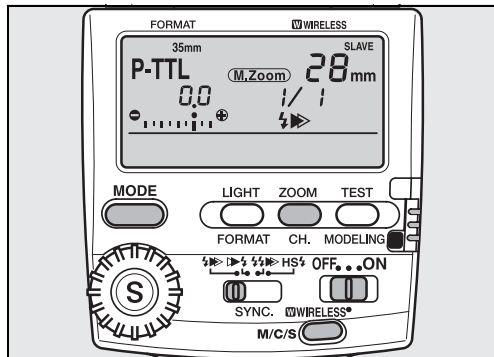

- You cannot set the flash unit to SLAVE while the exposure metering timer is on (while information relating to aperture etc. is displayed in the viewfinder).
 - ④ Slide down the setting switch to the (yellow dot) to display the channel on the LCD panel.
 - ⑤ Press the channel button (CH) and select a channel from 1CH to 4CH.
 - ⑥ Slide the setting switch back up to the (white dot).

⑦ When you turn the camera on and press the shutter release button halfway down, the channel is registered on the camera.

2 Next, remove the flash unit from the camera and place it in the desired position.

● **Press the flash mode button (MODE) to display (P-TTL) if the flash mode was set to the modes other than P-TTL.**

3 Set the zoom position. (Refer to page 21)

● **Set the zoom position with (M.Zoom) regardless of the lens you use.**

4 Enable the built-in flash unit of the camera and display (**WHS**) on the LCD panel.

5 Set the sync mode switch of the wireless flash unit to leading curtain sync (**⚡▶▶**).

6 Set the exposure mode of the camera to manual exposure and the shutter speed faster than X-sync speed.

● **If the shutter speed is the same or slower than the X-sync speed of the camera, the flash will be set to P-TTL mode, and when it is faster than X-sync speed, the flash will be set to high-speed sync mode.**

7 Confirm that the AF540FGZ and built-in flash unit are fully charged, and take the photograph. A lamp on the wireless flash unit will blink.

● **The built-in flash unit is used for control flash only. It will not be used for main flash.**

● **Refer to camera's operating manual for the operation of the camera.**

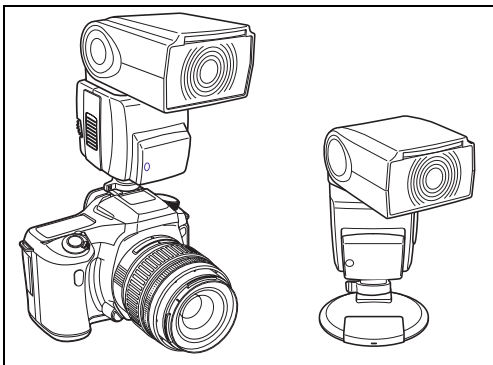

(Using the AF540FGZ in Combination with another AF540FGZ)

1 Firstly, set the wireless mode and channel of the AF540FGZ attached to the camera, and register the channel on the camera.

- ① Turn the camera off and then attach the AF540FGZ to the hot shoe of the camera.
- ② Set the power switch of the flash unit to (WIRELESS).

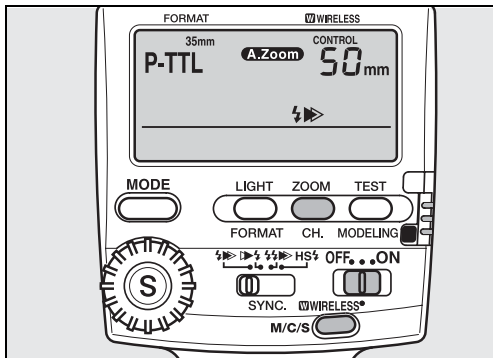

- ③ Press the wireless mode button (M/C/S) the number of times required to select CONTROL or MASTER.
CONTROL: For using the flash unit attached to the camera as the control flash.
MASTER: For using both flash units as main flashes.
- ④ Slide down the setting switch to the (yellow dot) to display the channel on the LCD panel.
- ⑤ Press the channel button (CH) and select a channel from 1CH to 4CH.

- ⑥ Slide the setting switch back up to the (white dot).
- ⑦ When you turn the camera on and press the shutter release button halfway down, the channel is registered on the camera.

2 Next, set the channel of the separated (wireless) flash unit to the same channel as the flash unit attached to the camera.

- ① Place the other AF540FGZ in the desired position.
- ② Set the power switch of the flash unit to (WIRELESS).
- ③ Press the wireless mode button (M/C/S) the number of times required to display SLAVE on the LCD panel.
- ④ Slide down the setting switch to the (yellow dot) to display the channel on the LCD panel.
- ⑤ Press the channel button (CH) and select the same channel that the flash unit attached to the camera has been set to.
- ⑥ Slide the setting switch back up to the (white dot).

● **The two flash units must be set to the same channel, otherwise the separated flash unit will not discharge.**

3 Set the sync mode switch of the wireless flash unit to leading curtain sync (⚡▶▶).

4 Set the exposure mode of the camera to manual exposure and the shutter speed faster than X-sync speed.

● **If the shutter speed is the same or slower than the X-sync speed of the camera, the flash will be set to P-TTL mode, and when it is faster than X-sync speed, the flash will be set to high-speed sync mode.**

5 Confirm that both flash units are fully charged, and take the photograph.
A lamp on the wireless flash unit will blink.

■ Slave

With the AF540FGZ, you can take photographs with the flash unit separated from the camera wirelessly in auto or manual mode.

Combine the flash unit with the built-in flash unit of the camera or another flash unit attached to the camera.

Before photographing, confirm the following.

1. Whether you can use this function with the combination of your camera and the flash mode you have set.

→ Functions Related to Each Flash Mode
(page 64 - 71)

2. Precaution When Photographing with a Slave Flash (page 79)

- Refer to page 63 for cameras that support wireless mode.

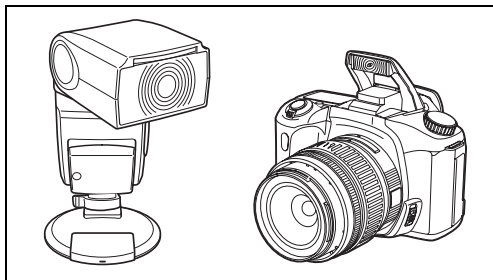

Procedure

- 1** Confirm that the slave mode is set to SL2. (Refer to page 52.)
- 2** Set the flash unit's power switch to (WIRELESS).
- 3** Press the wireless mode button (M/C/S) the number of times required to display SLAVE on the LCD panel.
- 4** Press the flash mode button (MODE) to set the flash mode.

- 5** Set the zoom position to suit the subject and place the flash unit at the desired location.
- **When setting up a flash unit separately from the camera, use the off-camera shoe adapter F when using a tripod, or the off-camera shoe clip CL-10 when setting up in another location such as tabletop, chair, etc.**
- 6** Turn the flash unit on the camera on.
- **If the camera's built-in flash unit is part of the combination, pop up the built-in flash unit.**
- 7** Check that the ready lamp is lit, then take the picture.
- **When charging is complete, (⚡) is lit in the viewfinder of the camera.**
 - **Position the slave unit(s) so that the slave sensor can receive the flash discharged by the camera's built-in flash unit or attached flash unit.**
 - **The AF540FGZ will discharge at the same time that the camera's flash discharges.**
 - **Keep the distance from the built-in flash unit and AF540FGZ to the subject within 4 meters.**
 - **The slave unit will turn off automatically after about 1 hour of non-operation when the auto power off function is set.**
- **Do not use red-eye reduction with the camera's flash. This will result in the AF540FGZ firing by the pre-flash. For the same reason, set the camera to manual focus when firing the flash continuously so that the AF spotbeam does not operate with cameras that have AF spotbeam functions.**

■ Slave Mode Setting

To properly control the slave flash, it is necessary to set the slave mode settings.

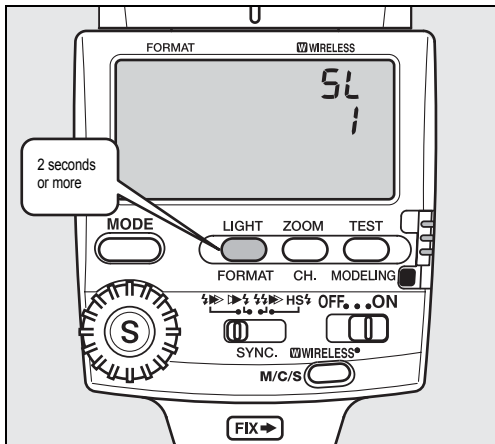

Procedure

- 1** Slide the setting switch up.
- 2** Press the LCD panel illumination button (LIGHT) for 2 seconds or more. SL1 will be displayed.
- 3** Press the select button (S) to select SL 1 or SL 2.
SL 1: When photographing in wireless mode
SL 2: When photographing with slave flash
- **The flash will not discharge properly if the slave mode was set to the wrong mode. It may not discharge at all or may discharge simultaneously with the control flash.**
- 4** Press the LCD panel illumination button (LIGHT) to finish setting.
- **In SL 2, fluorescent lamps flicker may contribute to flash unit's erroneous firing on rare occasions.**

■ **Slow-Speed Sync Photography**

When using a normal flash to photograph a subject in a night or evening setting, the background will appear very dark because a normal flash light cannot sufficiently light it. However, it is possible to balance both subject and background by using the flash to properly expose the foreground subject and a slow shutter speed to expose the low light background. Before photographing, confirm the following.

1. Whether your camera support this function

→ **Cameras that Support Slow-Speed Sync Mode (page 64)**

2. Whether you can use this function with the combination of your camera and the flash mode you have set.

→ **Functions Related to Each Flash Mode (page 64 - 71)**

● **Refer to the camera operation manual for details.**

■ Bounce Flash

With the AF540FGZ, you can tilt and swivel the flash head to aim at the ceiling or wall to bounce the flash before it reaches the subject. Doing so creates softer light and shadows to make the picture look more natural. Bouncing the flash will decrease the flash intensity by the time it reaches the subject. Therefore, this function is effective when photographing in P-TTL or TTL mode at short distances.

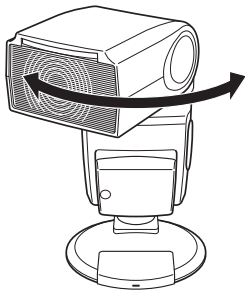

The bounce angle can be set to the following angles.

Rightward: 0°, 30°, 60°, 90°, 120°, 150°, 180°

Leftward: 0°, 30°, 60°, 90°, 135°

Upward: 0°, 30°, 45°, 60°, 75°, 90°

Downward: 0°, -10°

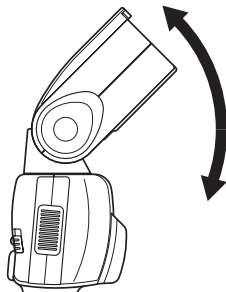

- A click stop is provided for each bounce angle.
- Hold the bounce lock release button and tilt the flash head downward when you set the bounce angle at -10° .
- When using bounce flash, () will be displayed on the LCD panel.
- The effective flash range will blink only when the bounce angle is set at -10° .
- It is recommended to set the bounce angle at -10° to prevent uneven exposure when the distance to the subject is within 1m.

P-TTL, TTL Auto Flash Photography

The amount of reflective light will change according to the condition of the reflective surface, angle, and distance. However, with TTL auto flash units bounce flash photography can be relatively easily done. Confirm the flash status indicator in the viewfinder or the auto check display in the LCD panel when taking pictures.

Manual Flash Photography

The amount of light during bounce flash photography is greatly affected by the condition of the reflective surface, therefore test pictures should be taken beforehand or changing the exposure and taking several pictures may be recommended.

- **When taking color photographs, if the reflective surface for the bounce flash is colored, the picture will be affected by the color and unless this is intentional, a white surface should be used.**
- **Bounce flash photography is greatly affected by the surrounding conditions. A photography manual and other references are recommended.**

■ AF Spotbeam

The AF540FGZ features a built-in red spotbeam projector to assist the autofocus system in dim light and low-contrast conditions. When using the flash with autofocus camera in dark conditions, the spotbeam will be projected automatically depending on the ambient lighting conditions. This function is activated only when the camera is set to autofocus. By setting the flash mode to (SB), the AF540FGZ can be used exclusively as a focusing aid in dim light.

Using the AF540FGZ Spotbeam Exclusively as a Focusing Aid

1. Set the power switch to the (ON) position.
2. Press the flash mode button (MODE) to select (SB).
3. Set the camera to the autofocus mode.
4. Press the shutter release button halfway down to let the AF spotbeam discharge.

- **The AF spotbeam does not work in bright light conditions.**
- **If the In-focus indicator does not light up in several seconds, it means that the subject is hard to autofocus. In this case, use the manual focus mode to focus on the subject.**

- **To change the composition, raise your finger off the shutter release button and press it halfway down again to recompose the picture.**
- **When using the AF540FGZ's built-in AF spotbeam, the AF spotbeam built into the camera will not operate.**
- **The AF spotbeam on the flash unit works accurately only when mounted onto the camera's hot shoe.**
- **The flash does not discharge when using the AF540FGZ spotbeam exclusively as a focusing aid.**

■Wide-Angle Panel and Catchlight Panel

The AF540FGZ has a built-in wide-angle panel and catchlight panel at the top of the flash head. Execute the following if necessary.

1 Pull out both the wide-angle panel and catchlight panel.

2 Store the panel you are not using.

- When storing the wide-angle panel, push it inward while holding the catchlight panel so that it does not catch on the catchlight panel.
- When storing the catchlight panel, do so by pushing it inward.

1.Wide-angle panel

The wide-angle panel expands flash coverage angle for the following lenses. The flash zoom position will be fixed at the same position as the focal length of the lens.

13 mm for digital camera (K series, *ist D series),
25mm for digital camera (645D), 20 mm for 35 mm camera, 35mm for 645 camera, 55mm for 67 camera.

2.Catchlight panel

A catchlight is a reflection of light source in the eyes. It usually appears as a white dot and makes the human subject look more lively. Set the bounce flash angle to 90° and get close to the subject before taking the picture.

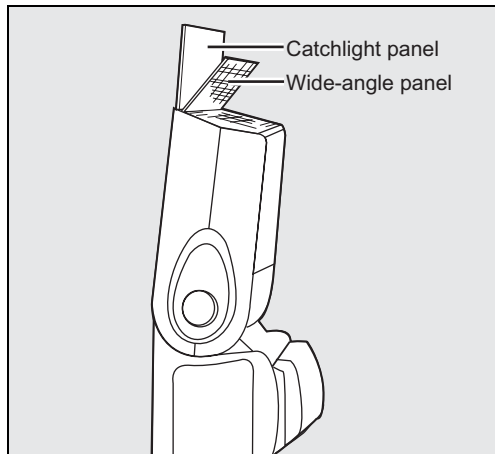

■ Modeling Flash/Test Flash

Before taking the picture, firing a modeling flash helps you to see how shadows are cast on the subject.

Modeling Flash

- 1** Slide the setting switch down (yellow dot).
 - 2** Check that the flash is ready, then press the modeling button (MODELING). The flash will discharge continuously for one second.
 - 3** After firing the modeling flash, slide the setting switch up (white dot).
- **To prevent the flash tube from overheating or deteriorating, do not discharge the modeling flash more than 10 consecutive times. After the tenth time, let the flash unit rest for at least 10 minutes.**

Test Flash

Check that the flash is ready, then press the test button (TEST). The test flash will discharge.

Cameras Capable of Modeling Flash or Test Flash Photography Using the Camera Button

With the following cameras, a button on the camera can be used instead of the modeling button (MODELING) or the test button (TEST). This operation can be carried out with either an attached flash unit or a wireless flash unit. For information on how to arrange this, refer to the operating manual for the camera.

*ist D: You can use the OK button. (Refer to "Custom Function Chart" in the camera's operating manual.)

*ist: You can use the flash pop-up button. (Refer to "Setting the Custom Function" in the camera's operating manual.)

MZ-S: You can use the LCD illuminator button. (Refer to "PENTAX Functions" in the camera's operating manual.)

■ Connecting the AF540FGZ with the Extension Cord

When using the AF540FGZ separately from the camera connected by an extension cord, use the optional extension cord F5P/F5P L. Attach the extension cord F5P/F5P L to the camera using the optional hot shoe adapter F_G or the optional hot shoe adapter F (refer to the diagram on the right).

- When using the AF540FGZ in combination with the built-in flash unit of the following cameras, use the hot shoe adapter F_G. If you use the hot shoe adapter F, the built-in flash unit will not pop up.

K-x, K-7, K-m/K2000, K20D, K200D, K100D Super, K10D, K110D, K100D, *ist DL2, *ist DS2, *ist DL, *ist DS, *ist D, *ist, MZ-L/ZX-L/MZ-6, MZ-S, MZ-60/ZX-60, MZ-5N/ZX-5N, MZ-30/ZX-30, MZ-7/ZX-7, MZ-3,

MZ-5/ZX-5, MZ-10/ZX-10, MZ-50/ZX-50

You can use the hot shoe adapter F with any cameras other than those above.

- The 67 II does not come with a hot shoe. The optional hot shoe grip 67 II should be used. Refer to the hot shoe grip 67 II operating manual for instructions.

- When setting up the flash unit separately from the camera, use the off-camera shoe adapter F when using a tripod, or the optional off-camera shoe clip CL-10 when setting up in another location such as tabletop, chair, etc.
- The off-camera shoe adapter F cannot be attached to the bundled stand.

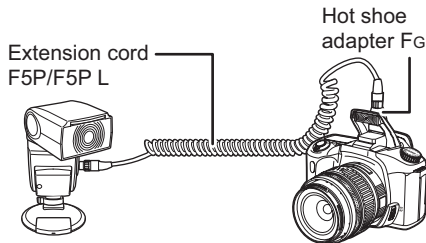

Supported Functions for PENTAX Cameras

■ Cameras that Support Each Flash Mode

Cameras that support each of the flash modes are listed below.

Please note that functions related to each flash mode differ. Refer to "Functions Related to Each Flash Mode" (page 64 - 71).

Flash Mode	Camera	Notes
P-TTL Auto Flash (P-TTL)	645D, K-x, K-7, K-m/K2000, K20D, K200D, K100D Super, K10D, K110D, K100D, *ist DL2, *ist DS2, *ist DL, *ist DS, *ist D, *ist, MZ-L/ZX-L/MZ-6, MZ-S	<ul style="list-style-type: none">- When the exposure mode is Programmed AE, Shutter Priority AE, or Aperture Priority AE, even if you set the flash mode to manual (M), it will automatically switch to (P-TTL) while the camera's exposure meter is operating (while information is being displayed in the viewfinder). You can actually use Manual flash mode (M) when the camera exposure mode is set to Manual (M). (With the 645D, K-x, K-7, K-m/K2000, K20D, K200D, K100D Super, K10D, K110D, K100D, *ist DS2, *ist DS, and *ist D, if the aperture of the lens is in a position other than A, the flash mode will switch to TTL.)- In trailing curtain sync or contrast control sync mode, the flash mode will automatically be switched to (P-TTL) when you press the shutter release button halfway down, even if you have set it to manual (M).- If the camera exposure metering timer is on, you cannot select (A) or (M) by pressing the flash mode button (MODE).- Although (P-TTL) is displayed in the following cameras, the actual photograph is taken with (TTL). LX, Super A/Super Program, 645

Flash Mode	Camera	Notes
TTL Auto Flash (TTL)	67 II	<ul style="list-style-type: none"> - In trailing curtain sync or contrast control sync mode, the flash mode will automatically be switched to (TTL) when you press the shutter release button halfway down, even if you have set it to manual (M).
	645N II, 645N, Z/PZ series, MZ/ZX series (except MZ-M/ZX-M), SFX _N /SF1 _N , SFX/SF1	<ul style="list-style-type: none"> - When the exposure mode is Programmed AE, Shutter Priority AE, or Aperture Priority AE, the flash mode will automatically be switched to (TTL), even if you have set it to manual (M). - In trailing curtain sync or contrast control sync mode, the flash mode will automatically be switched to (TTL) when you press the shutter release button halfway down, even if you have set it to manual (M). - If the camera exposure metering timer is on (information is displayed in the viewfinder), you cannot select (A) or (M) by pressing the flash mode button (MODE). - You cannot use (TTL) with the SF7/SF10.
	645, Super A/ Super Program, LX	-
Auto Flash (A)	Aperture setting capable PENTAX single lens reflex cameras	<ul style="list-style-type: none"> - Under the following conditions, autofocus cameras can also use (A). <ul style="list-style-type: none"> - The camera exposure mode is set to manual exposure. - The camera exposure metering timer is off. - With the following combinations of cameras and exposure modes, you cannot photograph correctly if the aperture is set to a value brighter than F2. Camera: Z-5P, Z-5, Z-1P/PZ-1P, Z-1/PZ-1, SFX_N/SF1_N, SF7/SF10, SFX/SF1 Exposure mode: Programmed AE and Shutter Priority AE modes
Manual Flash (M)	Aperture setting capable PENTAX single lens reflex cameras	-

■ Cameras that Support Each Sync Mode

Cameras that support each of the sync modes are listed below.

Please note that the conditions under which they can be used differ depending on camera type and settings. For details, refer to the restrictions reference pages.

Sync Mode	Camera		Restrictions Reference Page
Leading curtain sync (⚡▶▶)	All PENTAX single lens reflex cameras provided with a hot shoe		page 72
Trailing curtain sync (▶▶⚡)	Digital single lens reflex cameras	645D, K-x, K-7, K-m/K2000, K20D, K200D, K100D Super, K10D, K110D, K100D, *ist DL2, *ist DS2, *ist DL, *ist DS, *ist D	page 72
	Film cameras (medium format)	67 II, 645N II, 645N	
	Film cameras (35mm autofocus single lens reflex cameras)	*ist, Z/PZ series, MZ/ZX series (except MZ-M/ZX-M), SFX _N /SF1 _N , SFX/SF1, SF7/SF10	
Contrast control sync (⚡⚡▶▶)	Digital single lens reflex cameras	645D, K-x, K-7, K-m/K2000, K20D, K200D, K100D Super, K10D, K110D, K100D, *ist DL2, *ist DS2, *ist DL, *ist DS, *ist D	page 74
	Film cameras (medium format)	67 II, 645N II, 645N	
	Film cameras (35mm autofocus single lens reflex cameras)	*ist, Z/PZ series, MZ/ZX series (except MZ-M/ZX-M), SFX _N /SF1 _N , SFX/SF1, SF7/SF10	

Sync Mode	Camera		Restrictions Reference Page
High-speed sync (HS) 	Digital single lens reflex cameras	645D, K-x, K-7, K-m/K2000, K20D, K200D, K100D Super, K10D, K110D, K100D, *ist DL2, *ist DS2, *ist DL, *ist DS, *ist D	page 76
	Film cameras (35mm autofocus single lens reflex cameras)	*ist, MZ-S, MZ-L/ZX-L/MZ-6	

■ Cameras that Support Wireless Mode

Function	Camera		Notes
Wireless Mode  (WIRELESS)	Digital single lens reflex cameras	645D, K-x, K-7, K-m/K2000, K20D, K200D, *ist DL2, *ist DS2, *ist DL, *ist DS, *ist D, K10D (NOTE)	<ul style="list-style-type: none"> - When photographing in wireless mode, set the slave mode to SL1 (refer to page 52). - You cannot photograph in wireless mode in combination with the built-in flash unit with the following cameras. K100D Super, K110D, K100D, *ist DL2, *ist DS2, *ist DS, *ist DL
	Film cameras (35mm autofocus single lens reflex cameras)	*ist, MZ-S, MZ-L/ZX-L/MZ-6	

(NOTE) For the K10D, the firmware must be updated to Version 1.10 or later (page 40).

You can use the slave flash instead, if your camera does not support wireless mode. In this case, the available flash modes are auto and manual (page 50).

■ Cameras that Support Slow-Speed Sync Mode

Function	Camera		Notes
Slow-speed sync	Digital single lens reflex cameras	645D, K-x, K-7, K-m/K2000, K20D, K200D, K100D Super, K10D, K110D, K100D, *ist DL2, *ist DS2, *ist DL, *ist DS, *ist D	Slow-speed sync is not possible in the following cameras except with B (Bulb Exposure). <ul style="list-style-type: none"> - Cameras that are not capable of setting the shutter speed slower than the flash X-sync speed. - Cameras in which the shutter speed is automatically switched to the X-sync speed when the flash unit has finished charging. - Cameras whose shutter speed can be switched manually only with B (Bulb Exposure).
	Film cameras (35mm autofocus single lens reflex cameras)	*ist, MZ/ZX series, Z/PZ series, SFX _N /SF1 _N , SFX/SF1, SF7/SF10	
	Film cameras (medium format)	67 II, 645N II, 645N, 645	
	Film cameras (35mm manual focus single lens reflex cameras)	Cameras that meet the following conditions: <ul style="list-style-type: none"> - Capable of setting the shutter speed slower than the flash X-sync speed. - The shutter speed is not automatically switched even if the flash unit has finished charging. 	

■ Functions Related to Each Flash Mode

Supported flash modes and sync modes differ for each camera model.

Refer to the following table.

(○: usable, △: usable under certain conditions, X: unusable, -: Flash mode not supported)

* Where the flash mode is set to SB (AF spotbeam), the flash unit will not discharge (refer to page 56).

1. Cameras that Support P-TTL Auto Flash Mode

Type A (Digital single lens reflex cameras):

645D, K-x, K-7, K-m/K2000, K20D, K200D, K100D Super,
K10D, K110D, K100D, *ist DL2, *ist DS2, *ist DL, *ist DS, *ist D

Type B (Film cameras (35mm autofocus single lens reflex)):

*ist, MZ-L/ZX-L/MZ-6, MZ-S

Flash Mode	(P-TTL) P-TTL auto flash photography		(TTL) TTL auto flash photography		(A) auto flash photography	(M) manual flash photography	(SB) AF spotbeam
	(A)	(B)	(A)	(B)	(A), (B)	(A)* ¹ , (B)	(A), (B)
Leading curtain sync	○	○	○	○	○	○	-
Trailing curtain sync	○	○	○	○	X	X	-
Slow-speed sync	○	○	○	○	○	○	-
High-speed sync	○	○	○	○	X	X	-
Automatic switching to X-sync speed when flash is charged	○	○	○	○	○	○	-
Flash ready display in viewfinder	○	○	○	○	○	○	-
Auto check display	X	○	X	○	X	X	-
Slave flash	X	○	X	○	○	○	-
Wireless control	○* ²	○	○	○	X	X	-
Red-eye reduction	○	○	○	○	○	○	-
AF spotbeam	○	○	○	○	X	○	○

*¹: Depending on the type of camera, if Exposure Metering is switched on, the flash mode switches to [P-TTL] or [TTL]. For details, see page 60.

*²: *ist D, K10D (the firmware must be updated to Version 1.10 or later)

2. Cameras that Support TTL Auto Flash Mode

<Film cameras (35mm autofocus single lens reflex cameras)>

Type A: MZ-60/ZX-60, MZ-5N/ZX-5N, MZ-30/ZX-30, MZ-7/ZX-7, Z-1/PZ-1, Z-5, Z-1P/PZ-1P, Z-5P, Z-20/PZ-20, Z-20P, Z-50P, Z-70P, SFX/SF1, SFXN/SF1N

Type B: MZ-3, MZ-5/ZX-5, MZ-10/ZX-10, MZ-50/ZX-50

Type C: Z-10/PZ-10

Flash Mode	(P-TTL) P-TTL auto flash photography	(TTL) TTL auto flash photography			(A) auto flash photography			(M) manual flash photography			(SB) AF spotbeam
	(A), (B), (C)	(A)	(B)	(C)	(A)	(B)	(C)	(A)	(B)	(C)	(A), (B), (C)
Leading curtain sync	-	○	○	○	○	○	○	○	○	○	-
Trailing curtain sync	-	○	○	○	X	X	X	X	X	X	-
Slow-speed sync	-	○	○	○	○	○	○	○	○	○	-
High-speed sync	-	X	X	X	X	X	X	X	X	X	-
Automatic switching to X-sync speed when flash is charged	-	○	○	○	○	○	○	○	○	○	-
Flash ready display in viewfinder	-	○	○	○	○	○	○	○	○	○	-
Auto check display	-	○	○	○	X	X	X	X	X	X	-
Slave flash	-	X	X	X	○	○	○	○	○	○	-
Wireless control	-	X	X	X	X	X	X	X	X	X	-
Red-eye reduction	-	○*1	△*2	X	○*1	△*2	X	○*1	△*2	X	-
AF spotbeam	-	○	○	○	X	X	X	○	○	○	○

*1: Only when combined with cameras provided with red-eye reduction. (Excluding the MZ-5N, Z-1P, and Z-5P.)

*2: Only when the AF540FGZ is detached from the camera and connected by an extension cord. (Excluding the MZ-3, MZ-5, MZ-10, and MZ-50.)

<Film cameras (medium format)>

Type D: 67 II

Type E: 645 N II, 645 N

Type F: 645

Flash Mode	(P-TTL) P-TTL auto flash photography	(TTL) TTL auto flash photography			(A) auto flash photography			(M) manual flash photography			(SB) AF spotbeam		
	(D), (E), (F)	(D)	(E)	(F)	(D)	(E)	(F)	(D)	(E)	(F)	(D)	(E)	(F)
Leading curtain sync	-	○	○	○	○	○	○	○	○	○	-	-	-
Trailing curtain sync	-	○	○	X	X	X	X	X	X	X	-	-	-
Slow-speed sync	-	○	○	X	○	○	X	○	○	X	-	-	-
High-speed sync	-	X	X	X	X	X	X	X	X	X	-	-	-
Automatic switching to X-sync speed when flash is charged	-	○	○	○	○	○	○	○	○	○	-	-	-
Flash ready display in viewfinder	-	○	○	○	○	○	○	○	○	○	-	-	-
Auto check display	-	○	○	○	X	X	○	X	X	○	-	-	-
Slave flash	-	X	X	X	○	○	X	○	○	X	-	-	-
Wireless control	-	X	X	X	X	X	X	X	X	X	-	-	-
Red-eye reduction	-	X	X	X	X	X	X	X	X	X	-	-	-
AF spotbeam	-	-	○	-	-	X	-	-	○	-	-	○	-

<Film cameras (35mm manual focus single lens reflex cameras)>

Type G: LX

Type H: Super A/Super Program

Flash Mode	(P-TTL) P-TTL auto flash photography	(TTL) TTL auto flash photography		(A) auto flash photography		(M) manual flash photography		(SB) AF spotbeam
		(G)	(H)	(G)	(H)	(G)	(H)	
Camera type	(G), (H)	(G)	(H)	(G)	(H)	(G)	(H)	(G), (H)
Leading curtain sync	-	○	○	○	○	○	○	-
Trailing curtain sync	-	X	X	X	X	X	X	-
Slow-speed sync	-	X	X	X	○	X	○	-
High-speed sync	-	X	X	X	X	X	X	-
Automatic switching to X-sync speed when flash is charged	-	○	○	○	○	○	○	-
Flash ready display in viewfinder	-	○	○	○	○	○	○	-
Auto check display	-	○	○	○	○	○	X	-
Slave flash	-	X	X	X	X	X	X	-
Wireless control	-	X	X	X	X	X	X	-
Red-eye reduction	-	X	X	X	X	X	X	-
AF spotbeam	-	-	-	-	-	-	-	-

3. Cameras that Does not Support P-TTL and TTL Auto Flash Mode

<Film cameras (35mm autofocus single lens reflex cameras)>

Type A: SF7/SF10

Flash Mode	(P-TTL) P-TTL auto flash photography	(TTL) TTL auto flash photography	(A) auto flash photography	(M) manual flash photography	(SB) AF spotbeam
Camera type	(A)	(A)	(A)	(A)	(A)
Leading curtain sync	-	-	○	○	-
Trailing curtain sync	-	-	X	X	-
Slow-speed sync	-	-	○	○	-
High-speed sync	-	-	X	X	-
Automatic switching to X-sync speed when flash is charged	-	-	○	○	-
Flash ready display in viewfinder	-	-	○	○	-
Auto check display	-	-	X	X	-
Slave flash	-	-	○	○	-
Wireless control	-	-	X	X	-
Red-eye reduction	-	-	○	○	-
AF spotbeam	-	-	X	○	○

<Film cameras (35mm manual focus single lens reflex camera, 67 camera)>

Type B: MZ-M/ZX-M

Type C: P30T, P30N/P3N, P30, P50/P5, A3Date, A3DateS, Program A/Program Plus

Type D: ME, ME-Super, MG, ME-F/MEF, MV1/MV

Flash Mode	(P-TTL) P-TTL auto flash photography	(TTL) TTL auto flash photography	(A) auto flash photography			(M) manual flash photography			(SB) AF spotbeam
			(B)	(C)	(D)	(B)	(C)	(D)	
Camera type	(B), (C), (D)	(B), (C), (D)	(B)	(C)	(D)	(B)	(C)	(D)	(B), (C), (D)
Leading curtain sync	-	-	○	○	○	○	○	○	-
Trailing curtain sync	-	-	X	X	X	X	X	X	-
Slow-speed sync	-	-	○	○* ¹	X	○	○* ¹	X	-
High-speed sync	-	-	X	X	X	X	X	X	-
Automatic switching to X-sync speed when flash is charged	-	-	○	○	○* ²	○	○	○* ²	-
Flash ready display in viewfinder	-	-	○	○	○* ²	○	○	○* ²	-
Auto check display	-	-	○	○	X	○	X	X	-
Slave flash	-	-	X	X	X	X	X	X	-
Wireless control	-	-	X	X	X	X	X	X	-
Red-eye reduction	-	-	X	X	X	X	X	X	-
AF spotbeam	-	-	-	-	-	-	-	-	-

*¹: Slow-speed sync with B (Bulb Exposure) for the A3Date and A3DateS.*²: Except ME.

Type E: 35mm single reflex cameras other than those in Type A to D, 67 camera

Flash Mode	(P-TTL) P-TTL auto flash photography	(TTL) TTL auto flash photography	(A) auto flash photography	(M) manual flash photography	(SB) AF spotbeam
Camera type	(E)	(E)	(E)	(E)	(E)
Leading curtain sync	-	-	○	○	-
Trailing curtain sync	-	-	X	X	-
Slow-speed sync	-	-	X	X	-
High-speed sync	-	-	X	X	-
Automatic switching to X-sync speed when flash is charged	-	-	X	X	-
Flash ready display in viewfinder	-	-	X	X	-
Auto check display	-	-	X	X	-
Slave flash	-	-	X	X	-
Wireless control	-	-	X	X	-
Red-eye reduction	-	-	X	X	-
AF spotbeam	-	-	-	-	-

■ Sync Mode Restrictions

Leading Curtain Sync Photography (⚡▶▶)

This sync mode can be used with all PENTAX single lens reflex cameras provided with a hot shoe. However, there are restrictions depending on camera type and settings.

Camera Model	Camera Settings	Restrictions
Z-1/PZ-1, Z-5, Z-1P/PZ-1P, Z-5P	Exposure mode: Programmed AE (Hyper Program), Hyper Program Aperture Priority AE, Aperture Priority AE, Hyper Manual by pressing IF button	The minimum shutter speed varies depending on the focal length of the lens you are using.
	Exposure mode: Hyper Program Shutter Priority AE	The minimum shutter speed changes depending on the ambient brightness.
SFX _N /SF1 _N	Exposure mode: Programmed AE, Shutter Priority AE	The shutter speed changes to within 1/60 to 1/125 sec.
	Exposure mode: Aperture Priority AE	The shutter speed is fixed at 1/125 sec.

Trailing Curtain Sync Photography (▶▶⚡)

Cameras that support this sync mode are as follows.

The shutter speeds that can be used differ according to the type of camera.

Camera Category	Camera Model	Shutter Speed
Digital single lens reflex cameras	K-x, K-7, K-m/K2000, K20D, K200D, K100D Super, K10D, K110D, K100D, *ist DL2, *ist DS2, *ist DL, *ist DS	1/90 sec. or slower
	645D, *ist D	1/60 sec. or slower
Film cameras (medium format)	67 II	1/15 sec.fixed (in Aperture Priority AE)
		1/15 sec. or slower (in manual exposure)

Camera Category	Camera Model	Shutter Speed
Film cameras (medium format)	645N II, 645N	1/45 sec. fixed (in Programmed AE and Aperture Priority AE)
		1/45 sec. or slower (in Shutter Priority AE and manual exposure)
Film cameras (35mm autofocus single lens reflex)	MZ-S	1/90 sec. or slower
	Z-1/PZ-1, Z-5, Z-1P/PZ-1P, Z-5P	1/125 sec. or slower (in Programmed AE and Aperture Priority AE in Hyper Program)* ¹
		1/125 sec. or slower (in Shutter Priority AE in Hyper Program)* ²
	Z-10/PZ-10	1/60 sec. fixed (in Programmed AE)
		1/60 sec. or slower (in manual exposure)
	SFX _N /SF1 _N , SFX/SF1, SF7/SF10	1/60 sec. fixed (in Programmed AE, Shutter Priority AE and Aperture Priority AE)
1/60 sec. or slower (in manual exposure)		
35mm autofocus single lens reflex cameras other than those above	1/60 sec. or slower	

*1: The minimum shutter speed varies depending on the focal length of the lens you are using.

*2: The minimum shutter speed varies depending on ambient light.

- **Under the following condition, the flash mode automatically switches to P-TTL auto flash: the flash mode is set to manual flash (M), and the sync mode is set to trailing curtain sync (▶⚡).**
- **(▶⚡) is displayed on the LCD panel only in the following case:
The shutter release button of the camera is pressed halfway, and the camera exposure metering timer is on (information is displayed in the viewfinder).**
- **The built-in flash units of the following cameras do not have the trailing curtain sync function. When used in combination with the AF540FGZ, the built-in flash unit does not discharge - only the external flash unit discharges.
SFX/SF1, SFX_N/SF1_N, SF7/SF10, Z-10/PZ-10**

Contrast Control Sync Photography (⚡➡➡)

Flash units that support this sync mode are as follows.

However, the flash modes, cameras, and camera shutter speeds that can be used differ depending on the flash unit. Set the shutter speed to the speed shown in the shutter speed column below.

Flash Unit	Flash Mode	Camera Model
AF540FGZ, AF360FGZ, AF200FGZ, built-in flash units	P-TTL auto flash (Even if you set the flash to another flash mode, the photograph is automatically taken in P-TTL auto flash mode.)	645D, K-x, K-7, K-m/K2000, K20D, K200D, K100D Super, K10D, K110D, K100D, *ist DL2, *ist DS2, *ist DL, *ist DS, *ist D, *ist, MZ-S, MZ-L/ZX-L/MZ-6
AF330FTZ, AF500FTZ, AF400FTZ, AF240FT	TTL auto flash (Even if you set the flash to another flash mode, the photograph is automatically taken in TTL auto flash mode.)	67 II, 645N II, 645N, or any 35mm autofocus single lens reflex camera

Camera Category	Camera Model	Shutter Speed
Digital single lens reflex cameras	K-x, K-7, K-m/K2000, K20D, K200D, K100D Super, K10D, K110D, K100D, *ist DL2, *ist DS2, *ist DL, *ist DS	1/180 sec. or slower
	*ist D	1/150 sec. or slower
	645D	1/125 sec. or slower
Film cameras (medium format)	67 II	1/15 sec. fixed (in Aperture Priority AE)
		1/15 sec. or slower (in manual exposure)

Camera Category	Camera Model	Shutter Speed
Film cameras (medium format)	645N II , 645N	1/45 sec. fixed (in Programmed AE and Aperture Priority AE)
		1/45 sec. or slower (in Shutter Priority AE and manual exposure)
Film cameras (35mm autofocus single lens reflex cameras)	Z-1/PZ-1, Z-1P/PZ-1P, Z-5, Z-5P	1/60 sec. fixed (in Programmed AE and Aperture Priority AE in Hyper Program)* ¹
		1/60 sec. or slower (in Shutter Priority AE in Hyper Program)* ²
	Z-10/PZ-10	1/60 sec. fixed (in Programmed AE)
		1/60 sec. or slower (in manual exposure)
	SFX _N /SF1 _N , SFX/SF1, and SF7/SF10	1/60 sec. fixed (in Programmed AE)
		1/60 sec. or slower (in manual exposure)
All 35mm autofocus single lens reflex cameras other than above	1/60 sec. or slower	

*1: The minimum shutter speed varies depending on the focal length of the lens you are using.

*2: The minimum shutter speed varies depending on ambient light.

● **The flash mode automatically switches to P-TTL auto under the following condition:**

When the flash mode is set to manual flash (M), and the sync mode is set to contrast control sync

().







● () is displayed on the LCD panel only in the following case:

The shutter release button of the camera is pressed halfway, and the camera exposure metering timer is on (information is displayed in the viewfinder).

High-Speed Sync Mode Photography (HS)

Cameras that support this sync mode are as follows. Be sure to set your camera according to the following settings:

- Shutter speed: faster than flash unit's X-sync speed
- Exposure mode: Tv (Shutter Priority), Av (Aperture Priority), M (manual)
Exposure modes other than the above are not compatible with this sync mode. Refer to the Exposure Modes Not Supported by High-Speed Sync Mode column.

Camera Model	Exposure Modes Not Supported by High-Speed Sync Mode	Notes
K-x, K-m/K2000, K200D, K100D Super, K110D, K100D, *ist DL2, *ist DS2, *ist DL, *ist DS, *ist, MZ-L/ZX-L/MZ-6	AUTO PICT,  ,  ,  ,  ,  ,  , P (except *ist and MZ-L/ZX-L/MZ-6), SCN (K-x, K-m/K2000, K200D, K100D Super, K110D, K100D, *ist DL2), Sv (K-x, K-m/K2000, K200D, K100D Super, K100D), B (Bulb Exposure) modes	
645D, K-7, K20D, K10D, *ist D	Green (except 645D), Hyper Program (when programmed AE is activated), Sv (except *ist D) and B (Bulb Exposure) modes	You can photograph in high-speed sync mode using the following method when the camera is in Hyper Program mode. - Set the camera using the Av dial or Tv dial so that the shutter speed is faster than flash unit's X-sync speed.
MZ-S	P (Programmed AE) mode, B (Bulb Exposure) mode	







Slow-Speed Sync Photography Restrictions

Be sure to set the camera as follows.

- Shutter speed: slower than flash unit's X-sync speed
- Exposure mode: manual exposure, Shutter Priority AE, (except 645, SFX_N/SF1_N, SFX/SF1 and SF 7/SF10), B (Bulb Exposure)
Exposure modes other than the above are not compatible with this photographic method. Refer to the Exposure Modes Not Supported by Slow-Speed Sync Photography column.

You cannot perform slow-speed sync photography with settings other than B (Bulb Exposure) with the following cameras:

- Cameras that are not capable of setting the shutter speed slower than the flash X-sync speed
- Cameras in which the shutter speed is automatically switched to the X-sync speed when the flash unit has been charged.

Camera Model	Exposure Modes Not Supported by Slow-Speed Sync Photography	Notes
K-x, K-m/K2000, K200D, K100D Super, K110D, K100D, *ist DL2, *ist DS2, *ist DL, *ist DS, *ist, MZ-L/ZX-L/MZ-6, MZ-7/ZX-7	AUTO PICT,  ,  ,  ,  ,  ,  , P (except *ist and MZ-L/ZX-L/MZ-6), SCN (K-x, K-m/K2000, K200D, K100D Super, K110D, K100D, *ist DL2), Sv (K-x, K-m/K2000, K200D, K100D Super, K100D), Av (Aperture Priority) modes	

Camera Model	Exposure Modes Not Supported by Slow-Speed Sync Photography	Notes
645D, K-7, K20D, K10D, *ist D	Green (except 645D), Hyper Program (when programmed AE is activated), Av (Aperture Priority) modes and Sv (except *ist D)	<p>You can perform slow-speed sync photography using the following method when the camera is in Hyper Program mode.</p> <ul style="list-style-type: none"> - Set the camera using the Av dial or Tv dial so that the shutter speed is slower than flash unit's X-sync speed.
MZ-S, MZ-5N/ZX-5N, MZ-3, MZ-5/ZX-5, MZ-M/ZX-M, Z-50P, Program A/Program Plus	P (Programmed AE) and Av (Aperture Priority) modes	
MZ-50/ZX-50	PICT and Av (Aperture Priority) modes	
MZ-30/ZX-30	 , Av (Aperture Priority) modes	
MZ-10/ZX-10	Auto picture, PICT, and Av (Aperture Priority) modes	
Z-1P/PZ-1P, Z-5P, Z-5, Z-1/PZ-1	HyP (Hyper Program), Programmed AE mode, Av (Aperture Priority), and HyM (Hyper Manual) modes by pressing IF button	<p>You can perform slow-speed sync photography using the following method when the camera is in HyP (Hyper Program) mode.</p> <ul style="list-style-type: none"> - Set the camera using the Av dial or Tv dial so that the shutter speed is slower than flash unit's X-sync speed.

Camera Model	Exposure Modes Not Supported by Slow-Speed Sync Photography	Notes
Z-20P, Z-70P, Z-20/PZ-20	Green, Picture, and Av (Aperture Priority) modes	
Z-10/PZ-10	P (Programmed AE) mode	
645, SFX _N /SF1 _N , SFX/SF1, SF7/SF10, Super A/ Super Program	Programmed AE, Aperture Priority AE and Shutter Priority AE modes	
LX	Aperture Priority AE mode	

■ Precautions When Photographing with a Slave Flash

● Be sure to set the camera as follows:

- Exposure mode: M (manual) or B (Bulb Exposure)

* Exposure modes other than those above are not compatible with this photographic method.

● Set the slave mode of the flash unit to **SL 2** (refer to page 52).

Flash Effective Range

■ Calculating the Flash Effective Range

When setting the lens to manual f/stop, calculate the guide number at full flash with the use of flash's zoom position and ISO. Divide the resulting guide number by the aperture in use. Thus, the maximum distance is obtained. The minimum distance is obtained in dividing this max. distance by approx. 10.

However, if the minimum distance obtained is 0.7m or less, the minimum distance will be 0.7m. Refer to page 82 for the guide number table.

Example:

With a 85 mm lens at f/4 and sensitivity at ISO100

- ① For the zoom position 85mm and sensitivity at ISO100, the guide number is 54.
- ② $54 \text{ (guide number)} / 4 \text{ (aperture)} = 13.5\text{m (max. distance)}$
- ③ $13.5\text{m (max. distance)} / 10 = 1.35\text{m (min. distance)}$ Thus, flash effective range is approx. 1.35m - 13.5m.

Display of Flash Effective Range

The shooting distance parameters will be displayed on the LCD panel. Make sure that you are within the flash effective range before taking pictures.

- The effective flash range is displayed for the following camera and lens combinations.

Camera	Lens Types
645D, K-x, K-7, K-m/K2000, K20D, K200D, K100D Super, K10D, K110D, K100D, *ist D series	DA, D FA, FA J, FA, F, A
35mm autofocus single lens reflex cameras (except for SF series)	D FA, FA J, FA, F, A
645NII , 645N	FA645

If the maximum distance exceeds 22 meters, (▶) will blink. If the minimum distance is 0.7m or less, (—) will blink.

- The flash effective range varies depending on ISO, lens aperture in use, and/or the zoom position (flash coverage angle). Keep this in mind especially when you are using a variable aperture zoom lens.

Effective flash range indicator

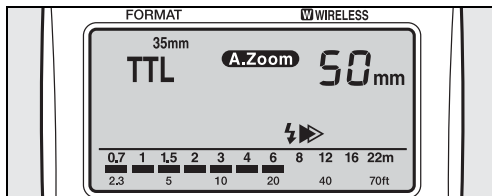

■ Guide Number (GN)

Guide numbers indicate flash light intensity. The larger the number, the farther you can reach with your flash.

From the guide number, you can easily obtain the proper aperture setting required for an optimum exposure.

$$\text{Aperture (f/stop)} = \frac{\text{GN/flash-to-subject distance (m)}}{\text{GN}}$$

- Depending on the camera and lens you are using, the effective flash range may be displayed. (Refer to page 81.)

Guide Number Table

*With the wide-angle panel attached

ISO	Flash light intensity	Camera format	Zoom position						
		35mm	85mm	70mm	50mm	35mm	28mm	24mm	*20mm
		645	150mm	135mm	100mm	70mm	55mm	45mm	*35mm
		67	190mm	180mm	120mm	90mm	70mm	60mm	*55mm
		DIGITAL	58mm	48mm	34mm	24mm	19mm	16mm	*13mm
645D	106mm	87mm	62mm	43mm	35mm	30mm	*25mm		
ISO100	1/1	54	50	45	39	35	32	21	
	1/2	38	35	32	27.5	24.5	22.5	14.5	
	1/4	27	24.5	22.5	19.5	17	16	10	
	1/8	19	17	16	13.5	12	11	7	
	1/16	13.5	12	11	9.5	8.5	7.5	5	
	1/32	9.5	8.5	8	6.5	6	5	3.5	
	1/64	6.7	6	5.6	4.6	4.2	3.5	2.4	

*With the wide-angle panel attached

ISO	Flash light intensity	Camera format	Zoom position						
		35mm	85mm	70mm	50mm	35mm	28mm	24mm	*20mm
		645	150mm	135mm	100mm	70mm	55mm	45mm	*35mm
		67	190mm	180mm	120mm	90mm	70mm	60mm	*55mm
		DIGITAL	58mm	48mm	34mm	24mm	19mm	16mm	*13mm
		645D	106mm	87mm	62mm	43mm	35mm	30mm	*25mm
ISO200	1/1	76	71	64	55	49	45	30	
	1/2	54	50	45	39	35	32	21	
	1/4	38	35	32	27.5	24.5	22.5	14.5	
	1/8	27	24.5	22.5	19.5	17	16	10	
	1/16	19	17	16	13.5	12	11	7	
	1/32	13.5	12	11	9.5	8.5	7.5	5	
	1/64	9.5	8.5	8	6.5	6	5	3.5	
ISO400	1/1	108	100	90	78	70	64	42	
	1/2	76	71	64	55	49	45	30	
	1/4	54	50	45	39	35	32	21	
	1/8	38	35	32	27.5	24.5	22.5	14.5	
	1/16	27	24.5	22.5	19.5	17	16	10	
	1/32	19	17	16	13.5	12	11	7	
	1/64	13.5	12	11	9.5	8.5	7.5	5	

High-Speed Sync Guide Number

*With the wide-angle panel attached

ISO	Shutter speed	Camera format	Zoom position						
		35mm	85mm	70mm	50mm	35mm	28mm	24mm	*20mm
		DIGITAL	58mm	48mm	34mm	24mm	19mm	16mm	*13mm
		645D	106mm	87mm	62mm	43mm	35mm	30mm	*25mm
ISO100	250	24.2	22.4	20.1	17.5	15.7	14.3	9.4	
	500	18.8	17.4	15.6	13.6	12.2	11.1	7.3	
	1000	14	13	11.7	10.1	9.1	8.3	5.5	
	2000	10.2	9.5	8.5	7.4	6.6	6	4	
	4000	7.3	6.8	6.1	5.3	4.8	4.3	2.9	
	6000	6.2	5.7	5.2	4.5	4.0	3.7	2.4	
ISO200	250	34.2	31.6	28.5	24.7	22.2	20.3	13.3	
	500	26.5	24.6	22.1	19.2	17.2	15.7	10.3	
	1000	19.8	18.4	16.5	14.3	12.8	11.7	7.7	
	2000	14.4	13.4	12.0	10.4	9.4	8.6	5.6	
	4000	10.4	9.6	8.6	7.5	6.7	6.1	4.0	
	6000	8.8	8.1	7.3	6.3	5.7	5.2	3.4	
ISO400	250	48.4	44.8	40.2	35	31.4	28.6	18.8	
	500	37.6	34.8	31.2	27.2	24.4	22.2	14.6	
	1000	28	26	23.4	20.2	18.2	16.6	11	
	2000	20.4	19	17	14.8	13.2	12	8	
	4000	14.6	13.6	12.2	10.6	9.6	8.6	5.8	
	6000	12.4	11.5	10.3	8.9	8.0	7.3	4.8	

■ P-TTL and TTL Auto Flash Effective Range

	Camera format	Zoom position													
		ISO 100							ISO 200						
	35mm	20mm	24mm	28mm	35mm	50mm	70mm	85mm	20mm	24mm	28mm	35mm	50mm	70mm	85mm
	645	35mm	45mm	55mm	70mm	100mm	135mm	150mm	35mm	45mm	55mm	70mm	100mm	135mm	150mm
	67	55mm	60mm	70mm	90mm	120mm	180mm	190mm	55mm	60mm	70mm	90mm	120mm	180mm	190mm
	DIGITAL	13mm	16mm	19mm	24mm	34mm	48mm	58mm	13mm	16mm	19mm	24mm	34mm	48mm	58mm
	645D	25mm	30mm	35mm	43mm	62mm	87mm	106mm	25mm	30mm	35mm	43mm	62mm	87mm	106mm
f/stop	f/1.2	1.8 - 17.5	2.6 - 26.6	2.9 - 29.1	3.3 - 32.5	3.7 - 37.0	4.2 - 41.6	4.5 - 45.0	2.5 - 25.0	3.8 - 37.5	4.1 - 40.8	4.6 - 45.8	5.4 - 53.3	6.0 - 59.1	6.4 - 63.3
	f/1.4	1.5 - 15.0	2.3 - 22.8	2.5 - 25.0	2.8 - 27.8	3.2 - 32.0	3.6 - 35.7	3.9 - 38.5	2.2 - 21.4	3.3 - 32.1	3.5 - 35.0	4.0 - 39.2	4.6 - 45.7	5.1 - 50.7	5.5 - 54.2
	f/2	1.1 - 10.5	1.6 - 16.0	1.8 - 17.5	2.0 - 19.5	2.3 - 22.5	2.5 - 25.0	2.7 - 27.0	1.5 - 15.0	2.3 - 22.5	2.5 - 24.5	2.8 - 27.5	3.2 - 32.0	3.6 - 35.5	3.8 - 38.0
	f/2.8	0.8 - 7.5	1.2 - 11.4	1.3 - 12.5	1.4 - 13.9	1.6 - 16.0	1.8 - 17.8	2.0 - 19.2	1.1 - 10.7	1.6 - 16.0	1.8 - 17.5	2.0 - 19.6	2.3 - 22.8	2.6 - 25.3	2.8 - 27.1
	f/4	0.7 - 5.2	0.8 - 8.0	0.9 - 8.7	1.0 - 9.8	1.1 - 11.0	1.3 - 12.5	1.4 - 13.5	0.8 - 7.5	1.2 - 11.2	1.3 - 12.2	1.4 - 13.7	1.6 - 16.0	1.8 - 17.7	1.9 - 19.0
	f/5.6	0.7 - 3.7	0.7 - 5.7	0.7 - 6.2	0.7 - 7.0	0.8 - 8.0	0.9 - 8.9	1.0 - 9.6	0.7 - 5.3	0.8 - 8.0	0.9 - 8.7	1.0 - 9.8	1.2 - 11.4	1.3 - 12.6	1.4 - 13.5
	f/8	0.7 - 2.6	0.7 - 4.0	0.7 - 4.3	0.7 - 4.8	0.7 - 5.6	0.7 - 6.2	0.7 - 6.7	0.7 - 3.7	0.7 - 5.6	0.7 - 6.1	0.7 - 6.8	0.8 - 8.0	0.9 - 8.8	1.0 - 9.5
	f/11	0.7 - 1.9	0.7 - 2.9	0.7 - 3.1	0.7 - 3.5	0.7 - 4.0	0.7 - 4.5	0.7 - 4.9	0.7 - 2.7	0.7 - 4.0	0.7 - 4.4	0.7 - 5.0	0.7 - 5.8	0.7 - 6.4	0.7 - 6.9
	f/16	0.7 - 1.3	0.7 - 2.0	0.7 - 2.1	0.7 - 2.4	0.7 - 2.8	0.7 - 3.1	0.7 - 3.3	0.7 - 1.8	0.7 - 2.8	0.7 - 3.0	0.7 - 3.4	0.7 - 4.0	0.7 - 4.4	0.7 - 4.7
	f/22	0.7 - 0.9	0.7 - 1.4	0.7 - 1.6	0.7 - 1.7	0.7 - 2.0	0.7 - 2.2	0.7 - 2.4	0.7 - 1.3	0.7 - 2.0	0.7 - 2.2	0.7 - 2.5	0.7 - 2.9	0.7 - 3.2	0.7 - 3.4
f/32	0.7 - 0.7	0.7 - 1.0	0.7 - 1.0	0.7 - 1.2	0.7 - 1.4	0.7 - 1.5	0.7 - 1.6	0.7 - 0.9	0.7 - 1.4	0.7 - 1.5	0.7 - 1.7	0.7 - 2.0	0.7 - 2.2	0.7 - 2.3	

(Unit: m)

	Camera format	Zoom position						
		ISO 400						
	35mm	20mm	24mm	28mm	35mm	50mm	70mm	85mm
	645	35mm	45mm	55mm	70mm	100mm	135mm	150mm
	67	55mm	60mm	70mm	90mm	120mm	180mm	190mm
	DIGITAL	13mm	16mm	19mm	24mm	34mm	48mm	58mm
	645D	25mm	30mm	35mm	43mm	62mm	87mm	106mm
f/stop	f/1.2	3.5 - 35.0	5.4 - 53.3	5.9 - 58.3	6.5 - 65.0	7.5 - 75.0	8.4 - 83.3	9.0 - 90.0
	f/1.4	3.0 - 30.0	4.6 - 45.7	5.0 - 50.0	5.6 - 55.7	6.5 - 64.2	7.2 - 71.4	7.8 - 77.1
	f/2	2.1 - 21.0	3.2 - 32.0	3.5 - 35.0	3.9 - 39.0	4.5 - 45.0	5.0 - 50.0	5.4 - 54.0
	f/2.8	1.5 - 15.0	2.3 - 22.8	2.5 - 25.0	2.8 - 27.8	3.3 - 32.1	3.6 - 35.7	3.9 - 38.5
	f/4	1.1 - 10.5	1.6 - 16.0	1.8 - 17.5	2.0 - 19.5	2.3 - 22.5	2.5 - 25.0	2.7 - 27.0
	f/5.6	0.8 - 7.5	1.2 - 11.4	1.3 - 12.5	1.4 - 13.9	1.6 - 16.0	1.8 - 17.8	2.0 - 19.2
	f/8	0.7 - 5.2	0.8 - 8.0	0.9 - 8.7	1.0 - 9.7	1.2 - 11.2	1.3 - 12.5	1.4 - 13.5
	f/11	0.7 - 3.8	0.7 - 5.8	0.7 - 6.3	0.7 - 7.0	0.9 - 8.1	0.9 - 9.0	1.0 - 9.8
	f/16	0.7 - 2.6	0.7 - 4.0	0.7 - 4.3	0.7 - 4.8	0.7 - 5.6	0.7 - 6.2	0.7 - 6.7
	f/22	0.7 - 1.9	0.7 - 2.9	0.7 - 3.1	0.7 - 3.5	0.7 - 4.0	0.7 - 4.5	0.7 - 4.9
f/32	0.7 - 1.3	0.7 - 2.0	0.7 - 2.1	0.7 - 2.4	0.7 - 2.8	0.7 - 3.1	0.7 - 3.3	

(Unit: m)

Optional Accessories

A number of dedicated accessories are available for this flash unit.

TR Power Pack-3

External power source which supplies power from six C-size batteries.

Off-camera Shoe Clip CL-10

Setting clip for using the AF540FGZ as a wireless slave flash.

Hot Shoe Adapter F_G

Adapter for using the AF540FGZ as a separate flash unit using the extension cord F5P/F5P L. It can be used in combination with the built-in flash unit.

Off-camera shoe adapter F

Adapter for attaching an external flash unit, etc. on a tripod separated from the camera. It comes with a connector for the extension cord F5P/F5P L.

- **The off-camera shoe adapter F cannot be attached to the bundled stand.**

Hot Shoe Adapter F

Adapter for connecting the camera and extension cord F5P/F5P L. It also has a hot shoe on its top.

Extension Cord F5P/F5P L

0.5m/1.5m/L(Approx.3m)

5P synchro cord to use a flash unit for single lens reflex camera, such as the AF540FGZ or AF360FGZ, separately from the camera. It is used in combination with the hot shoe adapter F_G or F, and/or the off-camera shoe adapter F.

Hot Shoe Grip 67 II

Adapter for positioning a flash unit such as the AF540FGZ or AF360FGZ alongside the camera body. It connects to the 67 II 's 5P sync terminal with the included 5P Sync Cord.

Specifications

Type ————— Clip-on, TTL auto zoom flash unit with series control

Guide No. ————— Maximum 54 (ISO 100/m). In manual mode, seven-step adjustment from M1/1 to M1/64. The focal lengths in the table below are for 35 mm single lens reflex cameras. (when using 35mm format camera)
*Wide-angle panel used

(ISO 100)

Focal Length (Zoom position)	85mm	70mm	50mm	35mm	28mm	24mm	20mm*
(M1/1) (=FULL)	54	50	45	39	35	32	21
(M1/2)	38	35	32	27.5	24.5	22.5	14.5
(M1/4)	27	24.5	22.5	19.5	17	16	10
(M1/8)	19	17	16	13.5	12	11	7
(M1/16)	13.5	12	11	9.5	8.5	7.5	5
(M1/32)	9.5	8.5	8	6.5	6	5	3.5
(M1/64)	6.7	6	5.6	4.6	4.2	3.5	2.4

(ISO 200)

Focal Length (Zoom position)	85mm	70mm	50mm	35mm	28mm	24mm	20mm*
(M1/1) (=FULL)	76	71	64	55	49	45	30
(M1/2)	54	50	45	39	35	32	21
(M1/4)	38	35	32	27.5	24.5	22.5	14.5
(M1/8)	27	24.5	22.5	19.5	17	16	10
(M1/16)	19	17	16	13.5	12	11	7
(M1/32)	13.5	12	11	9.5	8.5	7.5	5
(M1/64)	9.5	8.5	8	6.5	6	5	3.5

(ISO 400)

Focal Length (Zoom position)	85mm	70mm	50mm	35mm	28mm	24mm	20mm*
(M1/1) (=FULL)	108	100	90	78	70	64	42
(M1/2)	76	71	64	55	49	45	30
(M1/4)	54	50	45	39	35	32	21
(M1/8)	38	35	32	27.5	24.5	22.5	14.5
(M1/16)	27	24.5	22.5	19.5	17	16	10
(M1/32)	19	17	16	13.5	12	11	7
(M1/64)	13.5	12	11	9.5	8.5	7.5	5

Flash duration (1/2 peak each) — (M1/1) flash: Approx. 1/1200 sec. (TTL) Fastest duration time: Approx. 1/20000 sec.

Recycling time/Total number of flashes

Battery type	Recycling time	Total number of flashes
AA Alkaline (LR6)	Approx. 6 sec.	Approx. 200
AA Nickel-Metal Hydride (Ni-MH) (2500mAH)	Approx. 6 sec.	Approx. 250
AA Lithium (FR6)	Approx. 6 sec.	Approx. 350
TR Power Pack III (C-size alkaline LR14 batteries)	Approx. 4.5 sec.	Approx. 700

Consecutive Discharge — Approx. 2 frames/sec. for 50 times, at M 1/16 output (with using AA alkaline LR-6 batteries)

Flash Coverage Angle — Auto zoom enabled with autofocus compatible camera and lens combination.

*Wide-angle panel used.

Zoom position	85mm	70mm	50mm	35mm	28mm	24mm	20mm*
Vertical Coverage	23°	26°	34°	45°	53°	60°	85°
Horizontal Coverage	31°	36°	46°	60°	70°	78°	98°

(7 step zoom)

Color temperature — Daylight (Suited for daylight color film)

Effective flash range — Approx. 0.8 m - 8.0 m (Guide No. 45, ISO 100, f/5.6)

AF spotbeam — Red beam emitted under low light or low-contrast conditions.

Effective range: Approx. 1 m - 7 m (According to our testing conditions.)

Film speed setting — ISO 25 - 1600

Flash modes	P-TTL auto, TTL auto, auto, manual.
Flash output compensation	In P-TTL mode, -3.0 to +1.0 levels (0.5 step increments)
Flash output setting	Wireless master, slave: (1/1 → 2/3 → 1/2 → 1/3) Manual: (1/1 → 1/2 → 1/4 → 1/8 → 1/16 → 1/32 → 1/64)
Flash sync mode	Leading curtain sync, Trailing curtain sync, Contrast control sync, High-speed sync.
Wireless flash	(Control system) Optical pulse transmission (Wireless position) Master (M), control (C), slave (S) (Channels) 1 to 4 Compatible modes: P-TTL, auto (A), manual (M) Effective range: Approx. 4 m (When set to SL 1. According to our testing conditions.)
Bounce flash	Vertical and horizontal bounce possible, click stops provided, lock provided at 0°. Rightward: 0°, 30°, 60°, 90°, 120°, 150°, 180° Leftward: 0°, 30°, 60°, 90°, 135° Upward: 0°, 30°, 45°, 60°, 75°, 90° Downward: 0°, -10°
Power saving	Automatic power-off: After approx. 3 min. of non-operation with the power (ON). 6 minutes in Auto. After 1 hour in the wireless mode. Quick power on: By pressing the camera's shutter release button halfway
Red-eye reduction	Operates with autofocus cameras equipped with red-eye reduction feature.
Modeling flash	Modeling button (MODELING) discharges flash consecutively for 1 second.
Wide-angle panel	Pull out manually and flash zoom position sets to 20mm.
Catchlight panel	Pull out manually.
LCD panel illumination	LCD panel illumination button (LIGHT) illuminates the LCD panel for about 10 sec. or press the button again to turn it off.
Power source	Four AA batteries, (Alkaline (LR6), Nickel-Metal Hydride (Ni-MH), or Lithium (FR6)) Optional external power source: TR Power Pack-3
Dimensions and weight	76 mm (W) × 142 mm (H) × 107 mm (T) (3.0" × 5.6" × 4.2") 380 g (13.4 oz.) without batteries

Warranty Policy

All PENTAX camera accessories purchased through authorized bona fide photographic distribution channels are guaranteed against defects of material or workmanship for a period of twelve months from date of purchase. Service will be rendered, and defective parts will be replaced without cost to you within that period, provided the equipment does not show evidence of impact, sand or liquid damage, mishandling, tampering, battery or chemical corrosion, operation contrary to operating instructions, or modification by an unauthorized repair shop. The manufacturer or its authorized representatives shall not be liable for any repair or alterations except those made with its written consent and shall not be liable for damages from delay or loss of use or from other indirect or consequential damages of any kind, whether caused by defective material or workmanship or otherwise; and it is expressly agreed that the liability of the manufacturer or its representatives under all guarantees or warranties, whether expressed or implied, is strictly limited to the replacement of parts as herein before provided. No refunds will be made on repairs performed by non-authorized PENTAX service facilities.

Procedure During 12-month Warranty Period

Any PENTAX which proves defective during the 12-month warranty period should be returned to the dealer from whom you purchased the equipment or to the manufacturer. If there is no representative of the manufacturer in your country, send the equipment to the manufacturer, with postage prepaid. In this case, it will take a considerable length of time before the equipment can be returned to you owing to the complicated customs procedures required. If the equipment is covered by warranty, repairs will be made and parts replaced free of charge, and the equipment will be returned to you upon completion of servicing. If the equipment is not covered by warranty, regular charges of the manufacturer or of its representatives will apply. Shipping charges are to be borne by the owner. If your PENTAX was purchased outside of the country where you wish to have it serviced during the warranty period, regular handling and servicing fees may be charged by the manufacturer's representatives in that country. Notwithstanding this, your PENTAX returned to the manufacturer will be serviced free of charge according to this procedure and warranty policy.

In any case, however, shipping charges and customs clearance fees are to be borne by the sender. To prove the date of your purchase when required, please keep the receipts or bills covering the purchase of your equipment for at least a year. Before sending your equipment for servicing, please make sure that you are sending it to the manufacturer's authorized representatives or their approved repair shops, unless you are sending it directly to the manufacturer. Always obtain a quotation for the service charge, and only after you accept the quoted service charge, instruct the service station to proceed with the servicing.

This warranty policy does not affect customer's statutory rights.
The local warranty policies available from PENTAX distributors in some countries can supersede this warranty policy.
Therefore, we recommend that you review the warranty card supplied with your product at the time of purchase, or contact the PENTAX distributor in your country for more information and to receive a copy of the warranty policy.

For customers in the USA

STATEMENT OF FCC COMPLIANCE

This device complies with Part 15 of the FCC Rules. Operation is subject to the following two conditions: (1) This device may not cause harmful interference, and (2) this device must accept any interference received, including interference that may cause undesired operation.

Changes or modifications not approved by the party responsible for compliance could void the user's authority to operate the equipment.

This equipment has been tested and found comply with the limits for a Class B digital device, pursuant to part 15 of the FCC Rules. These limits are designed to provide reasonable protection against harmful interference in a residential installation.

This equipment generates, uses and can radiate radio frequency energy and, if not installed and used in accordance with the instructions, may cause harmful interference to radio communications. However, there is no guarantee that interference will not occur in a particular installation. If this equipment does not cause harmful interference to radio or television reception, which can be determined by turning the equipment off and on, the user is encouraged to try to correct the interference by one or more of the following measures:

- Reorient or relocate the receiving antenna.
- Increase the separation between the equipment and receiver.
- Consult the dealer or an experienced radio/TV technician for help.

For customers in Canada

This Class B digital apparatus complies with Canadian ICES-003.

Pour les utilisateurs an Canada

Cet appareil numerique de la classe B est conforme a la norme NMB-003 du Canada.

Information for Users on Collection and Disposal of Old Equipment and Used Batteries



1. In the European Union

These symbols on the products, packaging and/or accompanying documents mean that used electrical and electronic equipments and batteries should not be mixed with general household waste.

Used electrical/electronic equipments and batteries must be treated separately and in accordance with legislation that requires proper treatment, recovery and recycling of these products.

Following the implementation by member states, private households within the EU states may return their used electrical/electronic equipments and batteries to designated collection facilities free of charge*.

In some countries your local retailer may also take back your old product free of charge if you purchase a similar new one.

*Please contact your local authority for further details.



By disposing of this product correctly you will help ensure that the waste undergoes the necessary treatment, recovery and recycling and thus prevent potential negative effects on the environment and human health which could otherwise arise due to inappropriate waste handling.

2. In other countries outside the EU

These symbols are only valid in the European Union. If you wish to discard these items, please contact your local authorities or dealer and ask for the correct method of disposal.



Cd

For Switzerland: Used electrical/electronic equipment can be returned free of charge to the dealer, even when you don't purchase a new product. Further collection facilities are listed on the home page of www.swico.ch or www.sens.ch.

Note for the battery symbol (bottom two symbol examples): This symbol might be used in combination with a designation for the chemical element or compound in use. In this case you have to comply with the requirement set by the Directive for the chemicals involved.

HOYA CORPORATION

PENTAX Imaging Systems Division

2-35-7, Maeno-cho, Itabashi-ku, Tokyo 174-8639, JAPAN
(<http://www.pentax.jp>)

**PENTAX Europe Imaging Systems S.A.S.
(European Headquarters)**

112 Quai de Bezons, B.P. 204, 95106 Argenteuil Cedex, FRANCE
(HQ - <http://www.pentaxeurope.com>)
(France - <http://www.pentax.fr>)

PENTAX Imaging Systems GmbH

Julius-Vosseler-Strasse 104, 22527 Hamburg, GERMANY
(<http://www.pentax.de>)

PENTAX Imaging Systems Limited

PENTAX House, Heron Drive, Langley, Slough, Berks SL3 8PN, U.K.
(<http://www.pentax.co.uk>)

PENTAX Imaging Company

A Division of PENTAX of America, Inc.

(Headquarters)
600 12th Street, Suite 300 Golden, Colorado 80401, U.S.A.
(PENTAX Service Department)
250 North 54th Street Chandler, Arizona 85226, U.S.A.
(<http://www.pentaximaging.com>)

PENTAX Canada Inc.

1770 Argentia Road Mississauga, Ontario L5N 3S7, CANADA
(<http://www.pentax.ca>)

PENTAX Trading (SHANGHAI) Limited

23D, Jun Yao International Plaza, 789 Zhaojiabang Road, Xu Hui District,
Shanghai, 200032 CHINA
(<http://www.pentax.com.cn>)

<http://www.pentax.jp/english>



The CE Mark is a Directive conformity mark of the European Union.

Free Manuals Download Website

<http://myh66.com>

<http://usermanuals.us>

<http://www.somanuals.com>

<http://www.4manuals.cc>

<http://www.manual-lib.com>

<http://www.404manual.com>

<http://www.luxmanual.com>

<http://aubethermostatmanual.com>

Golf course search by state

<http://golfingnear.com>

Email search by domain

<http://emailbydomain.com>

Auto manuals search

<http://auto.somanuals.com>

TV manuals search

<http://tv.somanuals.com>