

# PENTAX®

***IQZ***oom 928

***IQZ***oom 928 DATE

## OPERATING MANUAL

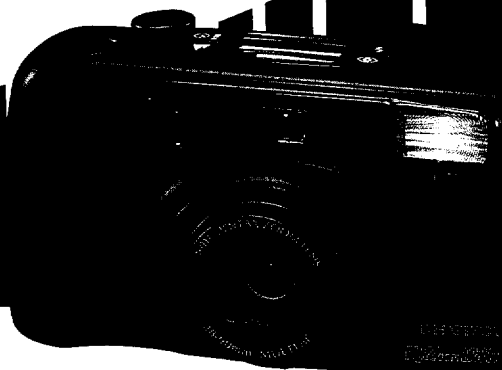

## OUTLINE OF BASIC OPERATIONS

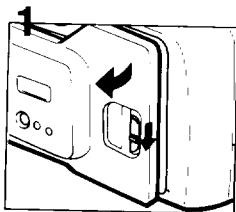

1 Open the back cover (see page 12).

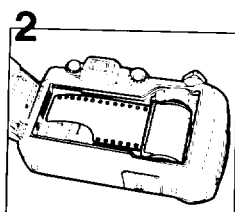

2 Load the film and close the back cover (see page 13).

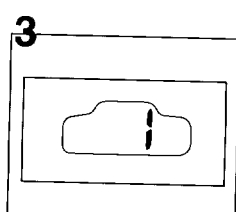

3 The film will automatically advance to the first frame (see page 13).

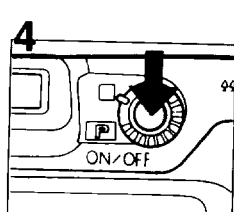

4 Push the Main Switch button to switch on power (see page 7).

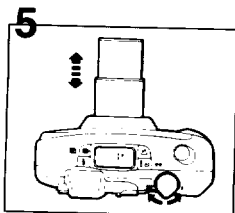

5 Frame your subject and operate the zooming lever to compose the shot (see page 10).



6 Focus on your subject (see page 18).

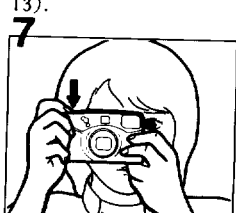

7 Depress the shutter release button. In dark conditions, the flash will discharge automatically (see page 19).

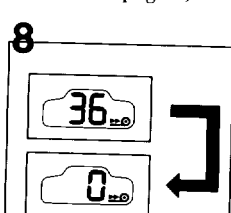

8 When the film is finished, the camera will automatically rewind it (see page 20).

Congratulations on your purchase of the PENTAX IQ Zoom 928 and welcome to the world of Pentax zoom compact photography! Your compact, light weight camera is a great companion to preserve your favorite memories. Its built-in 28-90mm zoom lens gives you the freedom to frame everything from breathtaking landscapes to family portraits, even detailed close-ups. The built-in auto flash helps you capture subjects in dimly-lit places or photograph indoor scenes with clarity and brilliance. Also included are panorama/standard format mid-roll switching capability and a wireless remote control feature. Since most of the operations-including film loading, film speed setting, winding/rewinding, focus and exposure control-are automatic, you can take great pictures effortlessly. The DATE model makes it easy to remember the dates when you took pictures.

- Please read this manual carefully before operating the camera, to help you take consistently superior pictures.
- Pay special attention to the cautions and notes in this Operating Manual. Pictures and illustrations shown herein may differ from the camera's actual appearance.

### Icon indicators used in this manual

Operation direction	←
Automatic operation	←.....→
Attention	○
Lamp lighted	☀
Lamp blinking	⋄
Correct	○
Incorrect	✕

The names of the camera's working parts are listed on the front and back flaps of this manual. Keep the flaps unfolded for quick reference while reading the manual.

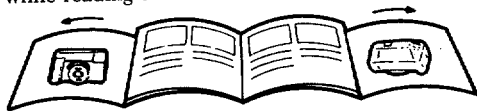

## NAMES OF WORKING PARTS

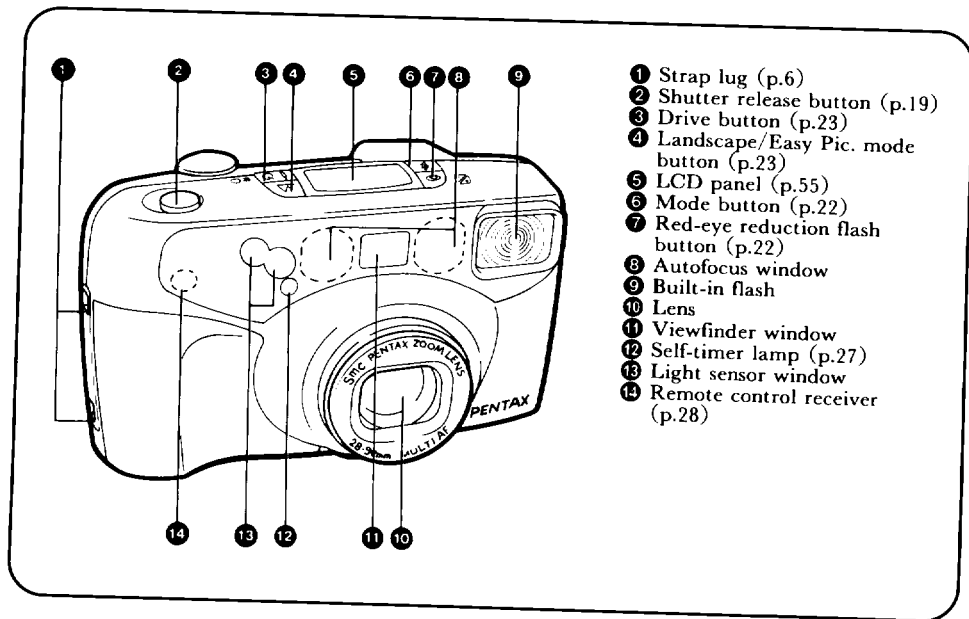

- ❶ Strap lug (p.6)
- ❷ Shutter release button (p.19)
- ❸ Drive button (p.23)
- ❹ Landscape/Easy Pic. mode button (p.23)
- ❺ LCD panel (p.55)
- ❻ Mode button (p.22)
- ❼ Red-eye reduction flash button (p.22)
- ❽ Autofocus window
- ❾ Built-in flash
- ❿ Lens
- ⓫ Viewfinder window
- ⓬ Self-timer lamp (p.27)
- ⓭ Light sensor window
- ⓮ Remote control receiver (p.28)

# TABLE OF CONTENTS

- Names of working parts .....Flaps
- Introduction .....Front foldout
- Outline of basic operations .....Inside cover
- Cautions .....2
- Practical shooting guide .....4

## PREPARATIONS BEFORE TAKING PHOTOGRAPHS

1. Strap attachment .....6
2. Main switch .....7
3. Battery check .....8
4. How to hold the camera .....9
5. Operating the 28-90mm zoom lens .....10

## TAKING PHOTOGRAPHS

1. Usable film .....11
2. Film loading .....12
3. Viewfinder displays and shooting ranges .....14
4. Lamp indications .....15
5. Ordinary photography .....16
6. Diopter adjustment .....17
7. Taking pictures .....18
8. Unloading the film .....20

## TAKING BETTER PHOTOGRAPHS

- How to select modes
  - /Red-eye reduction flash mode .....22
- Daylight-synchro shooting .....24
- Taking pictures at slow shutter speeds .....25
- Slow-shutter-speed-synch photography .....25
- Bulb shooting .....26
- Bulb-synchro shooting .....26
- Self-timer shooting .....27
- Using a wireless remote control .....28
- Multi-exposure shooting .....32
- Infinity-landscape shooting .....33
- Spot AF shooting .....34
- Easy pic. shooting .....35
- Focus-lock shooting .....36
- Exposure compensation .....38
- Panoramic format picture .....39
- DATE MODEL .....42

## MAINTENANCE CONSIDERATIONS

- Battery exhaustion warning .....44
- Installing/Replacing the battery .....45
- Taking care of your camera .....46
- Trouble shooting .....48
- Specifications .....50
- Warranty policy .....52
- LCD panel .....55

## CAUTIONS

- The electric circuitry inside the camera contains high voltage working parts. Never attempt to disassemble the camera.
- Be careful not to drop or subject the camera to strong vibrations, shock or pressure.
- Do not apply force to the zoom lens ; do not place the camera with the lens facing downward.
- Never attempt to manually open the lens cover : it will auto matically open and close as the main switch is turned on and off.
- Make sure not to obstruct the autofocus window, lens, light sensor window, or the built-in flash with your fingers, hair, or other object.
- Avoid leaving the camera for extended periods in places where temperature and humidity are high such as in a car.
- Dirt, mud, sand, moisture, toxic gas, water, salt water, etc., penetrating the inside of the camera may cause damage or render it inoperable. Damage of any kind will not be repaired under the terms of the warranty. Therefore, handle the camera with great care.
- Never use solvents such as paint thinner, alcohol or benzine to clean the camera.

## **PRECAUTIONS FOR BATTERY**

- The misuse of a battery can cause hazards such as leakage, overheating, explosions, etc. The battery should be inserted with the “+” and “-” sides facing correctly.
- Never try to disassemble, short or recharge the battery. Also, do not dispose of the battery in a fire, as it may explode.
- Battery performance may be temporarily hindered in low temperatures, but will recover in normal temperatures.
- Keep a spare battery on hand for replacement convenience when shooting outdoors or while traveling.
- Keep the battery out of the reach of children.
- When the camera is in a bag, ensure the main switch is off : otherwise, battery power may be wasted if the shutter release button is accidentally pushed.

# PRACTICAL SHOOTING GUIDE



## Focusing

Focusing on a particular spot of the subject .....	p.34
Taking a picture of distant landscape scenery .....	p.33
Taking a picture of a subject through a window .....	p.33



## Flash photography

Taking a picture in low light situations .....	p.16
Minimizing the picture of red-eye effect .....	p.22
Taking a picture of people whose face is cast in shadow .....	p.24
Taking a picture of people with night scenery in background .....	p.26



## Zooming

Compose the subject larger or smaller .....	p.10
---	------





### **Taking a picture of people in various situations**

Taking a picture of people whose face is cast in shadow .....	p.24
Taking a picture of people with sunset scenery in background .....	p.25
Taking a picture of people with night scenery in background .....	p.26
Putting yourself into a picture .....	p.27



### **Landscape photography**

Taking a picture of distant landscape scenery .....	p.33
Taking a picture of distant landscape through a window .....	p.33



### **Others**

Taking more than 2 pictures on the same frame .....	p.32
Taking a picture or zooming a lens at a distant place from the camera .....	p.28
Imprinting date on a picture .....	p.42



## STRAP ATTACHMENT

### PREPARATIONS BEFORE TAKING PHOTOGRAPHS

For optimum performance you should familiarize yourself with certain fundamentals before taking any photographs.

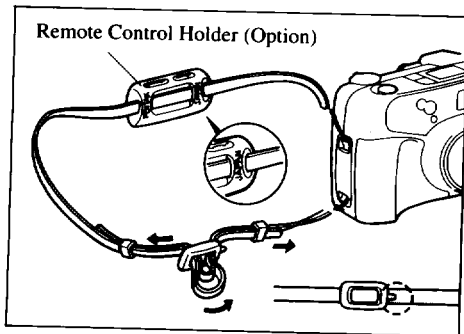

Fit the strap on the camera as illustrated. When attaching the Remote Control Holder to the strap, first remove the Wireless Remote Control from the Remote Control Holder, then pass the strap through the Remote Control Holder as illustrated. Use the tab on the clamp (see illustration) to depress the ADJUST button and to open the battery chamber cover.

- To prevent the camera from swaying a lot while walking, adjust the strap so the camera rides above your waist.



## MAIN SWITCH

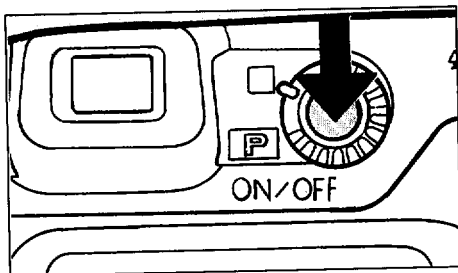

### Main Switch

To switch on, push the Main Switch button. The lens extends slightly to the wide-angle 28 mm setting and the LCD panel is on. To switch off, push the main switch button again. When not in use, ensure that the camera is switched off.

- Use one 3V lithium battery, type CR123A or the equivalent. Do not remove the battery before it is exhausted, since it is used by the date function on the DATE model to keep constant track of time.

- The lens cover automatically opens and closes when the main switch is turned on and off. Never attempt to open the lens cover manually.



## BATTERY CHECK

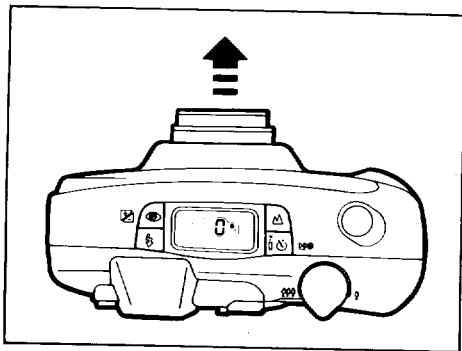

### Battery check

After you turn the Main Switch ON, the lens slightly extends and the lens cover opens. You are now ready to shoot. See page 44 when the battery exhaustion symbol (  ) appears on the LCD panel.

- If the camera is on and left unused for over 3 minutes, the lens automatically retracts and the power switches off to save battery power.
- If the Main Switch is turned on within 60 minutes of auto-power off, the previous setting will automatically return.



## HOW TO HOLD THE CAMERA

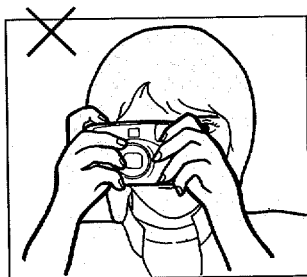
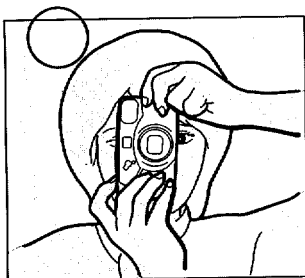
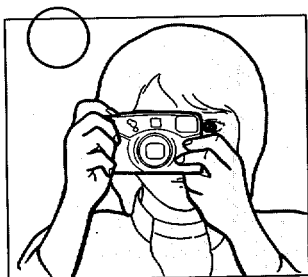

When shooting, hold the camera securely with both hands. Keep the camera as still as possible, and gently depress the shutter release button. (If too much force is applied, the camera is likely to shake, and the picture will be blurred.) Try to brace your elbows against your body, or support yourself and the camera against a stable, stationary object, such as a wall.

When using the flash with the camera positioned vertically, hold the camera so that the flash is above the lens.

### Caution :

Do not hold the zoom lens because it moves back and forth while in operation.

### Note:

- Make sure not to obstruct the autofocus window, lens, light sensor window or the built-in flash with your fingers, hair or other object.



## OPERATING 28-90mm ZOOM LENS



10

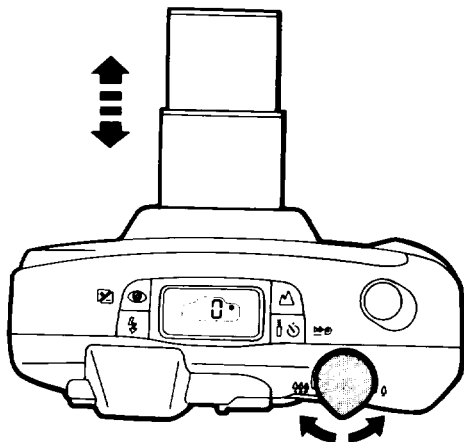

When you move the zooming lever to the right (◆), the lens moves towards the 90mm setting and frames the subject more closely. When you move the zooming lever to the left (◆◆◆), the lens moves towards the wide-angle 28mm setting. When the lens zooms to the desired setting, release the zooming lever and depress the shutter release button fully to take pictures.



## TAKING PHOTOGRAPHS

After reading this instruction manual you should be familiar with the functions available on the camera, and you're ready to insert the film.

### Notes:

- When buying DX-coded films, ensure that the package bears the "DX" mark.
- Non-DX coded film cannot be used.
- Use high-speed film with an ISO rating of 800 or higher mainly for shooting indoors in dimly-lit conditions.
- A film with ISO400 film speed is recommended to get less image blur and to cover more photographic situations.

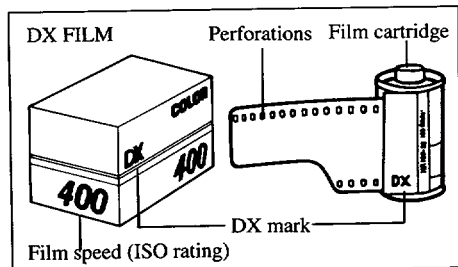

### Automatic film speed setting

This camera is designed to use DX-coded films with ISO ratings from 25 to 3200. When any of these films are loaded, the proper film speed is automatically set for the camera.



## FILM LOADING (Ensure the power is off before inserting the film.)

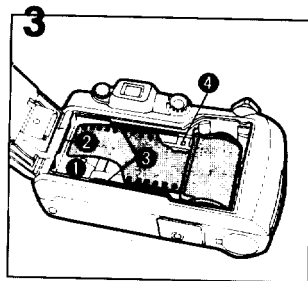
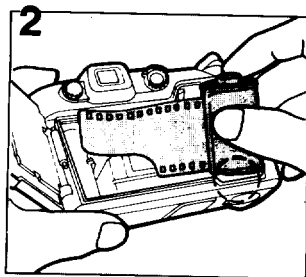
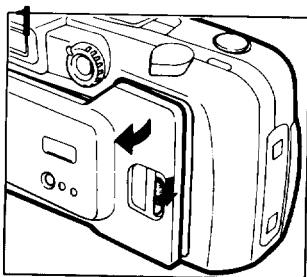

- 1 Slide the back cover release lever down in the direction of the arrow to open the back cover as illustrated.
- 2 Place the film cartridge in the film chamber by fitting its flat side on top of the rewind shaft first and then slide the top end into the camera.
- 3 Pull the film leader out far enough from the cartridge to reach the take-up spool ①. Align the tip of the film with the film leader end mark ②.

### Notes :

- Ensure the film is placed properly between the guide rails ③.
- If there is dirt on the film detector ④, film cannot be wound properly.

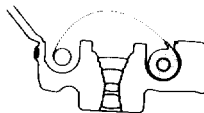

× Slack NO!

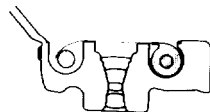

○ Flat YES!



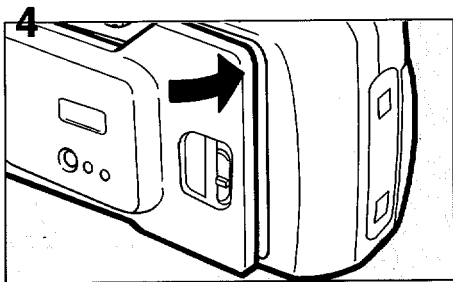

- 4 After the back cover is closed, the film automatically advances to the first frame.
- Even if no film is loaded, the motor operates for a second or two after the back cover is closed.

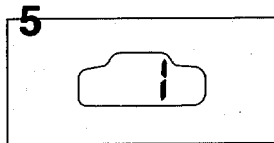

- 5 When "1" appears in the exposure counter on the LCD panel, the film automatically stops winding. The indication appears as shown above. If (1) does not appear on the LCD panel, it indicates that the film is not properly loaded. If this occurs, reload the film.
- If (E) blinks on the LCD panel, it means the film is not properly loaded.
- The exposure counter indication will remain on even if the main switch is turned off.

- Ensure the film is taut as illustrated on the previous page. Take up any slack in the film by pushing it back into the cartridge.
- If the end of the film leader is extremely bent, straighten it or cut off the bent portion.



## VIEWFINDER DISPLAYS AND SHOOTING RANGES

### Ordinary photography

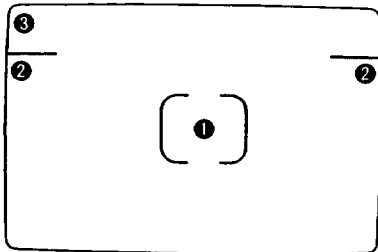

First, switch on power by depressing the Main Switch button.

### Ordinary photography (standard format)

- 1 Autofocus frame  
Focus on the subject with this frame.
- 2 Close distance compensation frame.  
When the camera-to-subject distance is between 0.58 m (1.9ft) and 1m (3.3ft), compose the scene within this frame.
- 3 Picture area  
When taking a normal picture, compose the scene within this frame.

### Panoramic format picture

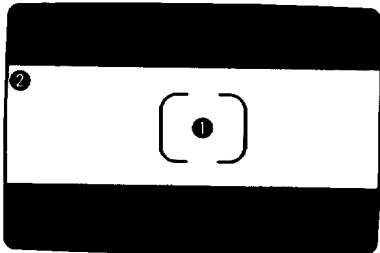

### Panoramic format picture

- 1 Autofocus frame  
Focus on the subject with this frame.
- 2 Picture area  
When taking panoramic format pictures, compose the scene within this frame.

Autofocus is referred to as "AF".

### Shooting ranges (effective camera-to-subject distance)

- The ordinary setting and panoramic mode allow a shooting range from  $\infty$  (infinity) to 0.58m (1.9ft).
- Subjects closer than 0.58m (1.9ft) cannot be focused properly.



## LAMP INDICATIONS

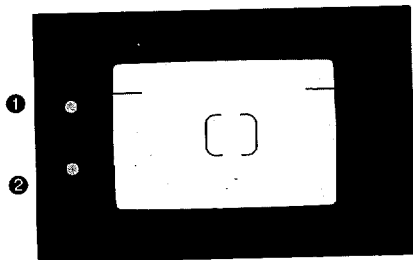

When you depress the shutter release button halfway down, the lamps ① and/or ② light up or blink as shown above.

- ① Green lamp : When the subject is in focus, it will light up to indicate that you can take the picture ; when the subject is not in focus, it will blink, indicating that you cannot take the picture because the camera-to-subject distance is too close.
- ② Red lamp : When the flash is ready to discharge, it will light up. When the flash is being charged, it will blink.

### Notes :

- If the subject is too close, the green lamp blinks. Adjust the camera-to-subject distance so that the green lamp lights continuously, then release the shutter.
- If the subject is even closer, the green lamp may light continuously, even though proper focus cannot be obtained.

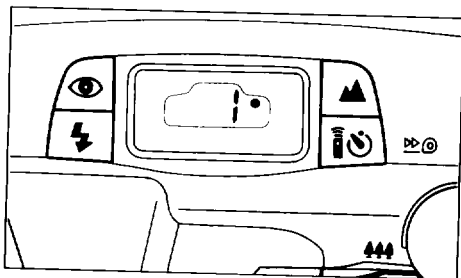

When the power is switched on by depressing the main switch button, the camera automatically selects the Auto and Single-Frame Shooting modes and the exposure counter indication remains on as shown above. These modes are used for taking ordinary pictures. The built-in flash will discharge automatically when the subject is poorly illuminated or in a backlight situation.

- When the LCD panel display is different from the one shown above (which indicates that other modes are set), switching power OFF and then ON restores the Auto and Single-Frame Shooting modes.

- When the built-in flash automatically discharges, the camera uses a shutter speed in the range from approx. 1/30th (28mm) to 1/45th sec. (90mm) when ISO100 film is used.



## DIOPTRER ADJUSTMENT

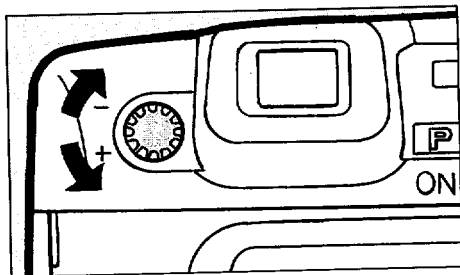

Aim the camera toward a bright subject. While looking through the viewfinder, adjust the diopter by turning the diopter adjustment dial until the AF frame appears clearest.



## TAKING PICTURES Shooting distance : 0.58m (1.9ft)-∞(infinity)



### 1 Composing the scene

After zooming the lens and composing your scene, focus on the subject with the autofocus frame in the center of the viewfinder.

- This camera uses multi-beam AF to focus the lens on the subject. Even if the subject is slightly off the AF frame, the subject will easily be brought into focus.
- To focus on a particular spot in the AF frame, select the AF spot mode. (See page 34.)
- When the power is turned on, the multibeam AF mode is automatically set.

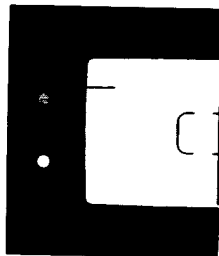
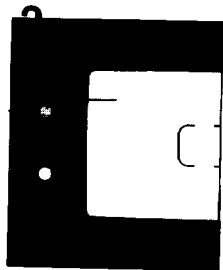

### 2 Checking the lamp indication

Depress the shutter release button halfway down. When the subject is in focus, the green lamp will light up. If the subject is closer than 0.58 meter (1.9ft), the green lamp will blink to warn you. In this case, extend the camera-to-subject distance until the green lamp is lit continuously.

- When the red lamp lights up, it indicates that the built-in flash will discharge. Ensure that you are within the flash effective range before shooting. (See page 19.)

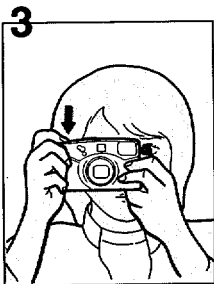

### 3 Shooting

Depress the shutter release button fully, and the shutter will be released. Then, the film automatically advances to the next frame.

#### Notes :

- When the shutter is released, the self-timer lamp momentarily lights up to indicate that a picture has been taken.
- If you wish to focus on another subject, lift your finger from the shutter release button and depress the shutter release button halfway down again.
- The shutter cannot be released while the lens is zooming.

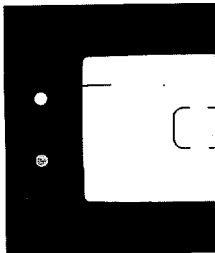

### Automatic Flash Emission

When taking pictures in low light or in a back-light situation, the flash will automatically discharge. When the shutter release button is depressed halfway down in low light, the red lamp will light up, indicating the flash is ready to discharge. If the red lamp blinks, this indicates that the built-in flash is being charged and the shutter cannot be released. Therefore, ensure that the red lamp is lit continuously before taking pictures.

### Red-eye

Shooting portraits with the flash may result in "red-eye", the red dot in your subject's eye. This camera includes a red-eye reduction flash function, which reduces the red-eye phenomenon by using pre-flash. See page 22 and 47 for details.

### Flash effective ranges (Nega-color film used)

lens	ISO	100	200	400
28mm (◆◆◆)		0.58-5.0m	0.58-7.0m	0.68-9.9m
90mm (◆)		0.58-2.4m	0.58-3.3m	0.58-4.7m



## UNLOADING FILM

(Remove the film from the camera in the shade or use your body to shade the camera.)

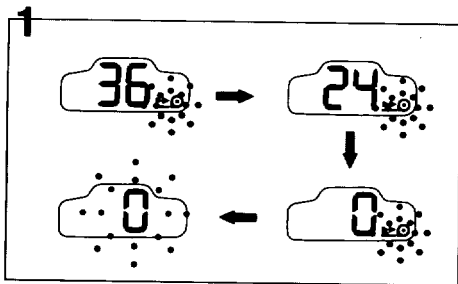

### 1 Rewinding the film

After you have exposed the last frame of the roll, the lens retracts and the film rewinds automatically. Then, the motor stops, and (Q) blinks as shown to indicate that the film has been rewound.

- A 24-exposure roll of film takes about 20 seconds to be rewound.
- During rewinding, the exposure counter counts frame numbers in reverse.
- The entire roll of film including the film leader is always rewound into the cartridge to prevent any part of the film being exposed to light.

20

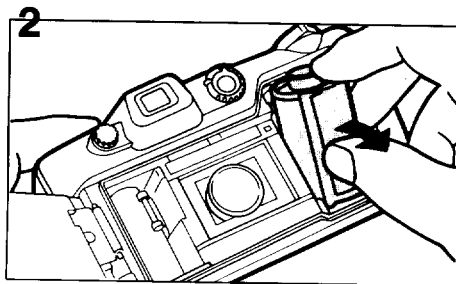

### 2 Unloading the film

To unload the film, open the back cover, and remove the cartridge from the chamber by pulling the top out first with your finger.

#### Notes :

- The shutter may be released a frame or two even after the specified number of frames have been used up as indicated by the number of shots shown on the film canister. If this occurs, these extra frames may be lost in the processing.
- Never open the back cover until the whole film roll is rewound.



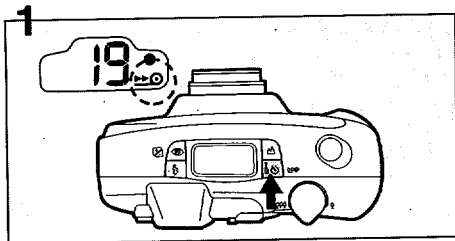

### 1 Rewinding a film in mid-roll

If you wish to unload a film before exposing all the frames, follow the procedures described below.

- 1 Turn the main switch ON and hold down the drive button for more than 3 seconds. (▶🎞) appears and ( ) starts blinking on the LCD panel, indicating that the mid-roll film rewinding mode has been set.

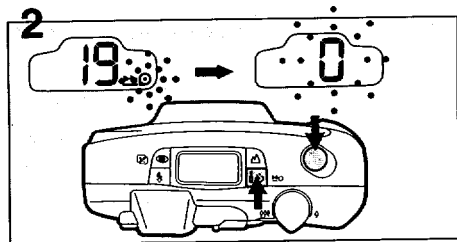

- 2 While depressing the drive mode button, depress the shutter release button. Film rewinding starts. When a roll of film is rewound to its end, the motor stops and (▶🎞) blinks, indicating that the back cover may be opened safely.

## TAKING BETTER PHOTOGRAPHS (HOW TO SELECT MODES/RED-EYE REDUCTION FLASH MODE)

To set various exposure modes, depress the Mode Button ❶.

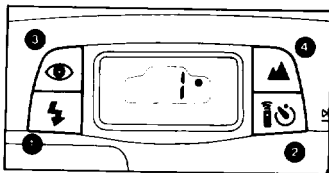
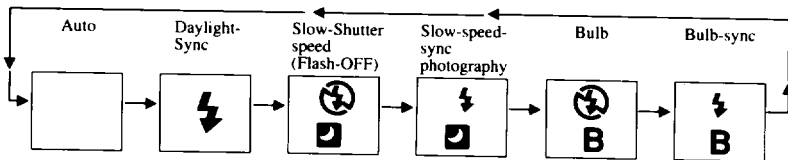

- To set various required modes, depress the button ❶, ❷ and/or ❸.
- For normal use, set the Auto and Single-Frame modes as shown on the left. When the power is switched on, the Auto and Single-Frame Shooting modes are automatically set.

### Red-Eye Reduction Flash Function

To reduce the red-eye phenomenon in the picture, depress the red-eye reduction flash button (Ⓜ) ❸. With this mode, the flash discharges two consecutive times, reducing the appearance of the red-eye effect. To cancel the mode, depress the red-eye reduction button again.

To set various shooting modes, depress the Drive Button ②

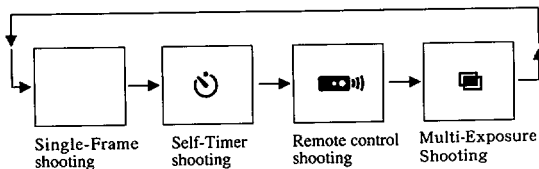

- In any exposure and/or shooting mode, if the button ① and ② are depressed after the shutter is released, the Auto and Single-Frame modes will return respectively.
- Holding down the Drive Button ② for more than three seconds sets the mid-roll rewinding mode (See page 21.).
- Holding down the Red-eye reduction flash button ③ for more than two seconds sets the Exposure compensation mode (See page 38).

To set various focusing modes, depress the Landscape/Easy Pic. Mode Button ④

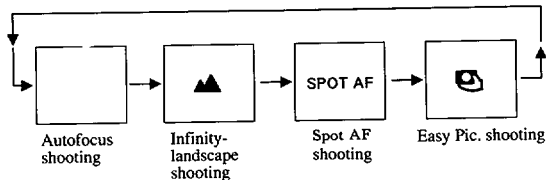

## DAYLIGHT-SYNCHRO SHOOTING

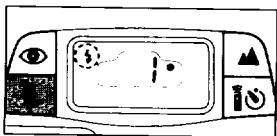

Depress the Mode Button until the (⚡) symbol appears on the LCD panel. The flash will discharge in both dark and

bright conditions. When a portrait is taken with the subject in a backlight situation, the front of the subject may be cast in shadow. In such a case, use the Daylight-Synchro Shooting mode (Flash-ON mode) within the flash-effective range to take pictures. This will ensure that a picture is well exposed without any shadow. When you wish to discharge the flash, use this mode. In this mode, the flash will always discharge.

### Notes :

- Ensure that the red lamp on the left-hand side of the viewfinder is lit when the shutter release button is depressed halfway down before shooting. A red lamp blinking indicates that the flash is being charged.
- Ensure you're within the flash effective range even when you use the built-in flash as a fill-in flash in daylight. (See page 19).



Without Daylight-Sync



With Daylight-Sync

## TAKING PICTURES AT A SLOW SHUTTER SPEED

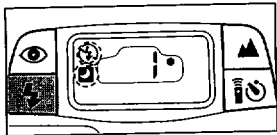

### Slow Speed (Flash OFF)

Depress the Mode Button until the (⚡) symbol appears

on the LCD panel. In this mode, the flash does not discharge, and a picture is taken at a slow shutter speed up to approx. 1/5 seconds. Use it in places where flash photography is prohibited, such as in theaters and museums. Furthermore, this mode is also useful for a natural existing light effect in low ambient light photography.

### Note :

- When shooting in low light, the shutter speed gets slower, and camera shake is likely to blur your picture. Use of a tripod is recommended.

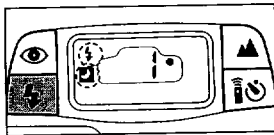

### Slow-Speed-Synchro Shooting (Flash-ON)

Depress the Mode Button to set the Slow-Speed-Synchro

mode until the (⚡) symbol appears on the LCD panel. It is possible to photograph subjects and background in a balanced way (as shown in the photo) by using the built-in flash to properly expose the foreground subject and a Slow-Shutter-Speed to expose the low light background.



## BULB, BULB-SYNCHRO SHOOTING

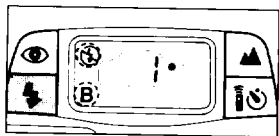

### Bulb mode (⚡B)

Depress the Mode Button until (⚡B) symbol appears on the LCD

panel. The shutter remains open up to 10 minutes as long as the shutter release button is held down. This mode is useful for long exposures required for shooting fireworks and night scenes, for instance. When using this mode, the camera should be mounted on a tripod so that the camera will be steady.



Bulb mode, approx. 5 sec. (ISO 100)

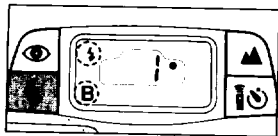

### Bulb-synchro mode (⚡B)

Depress the Mode Button until (⚡B) symbol appears

on the LCD panel, this lets you use the flash in addition to the Bulb mode, so you can take a portrait photograph with a night scene in the background, for example.

## SELF-TIMER PHOTOGRAPHY

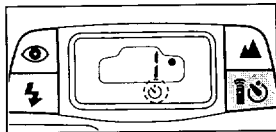

the Drive Button until the (Ⓢ) symbol appears on the LCD panel.

### Self-Timer

Use the Self-Timer if you wish to get in the picture. Use of a tripod is recommended. Depress

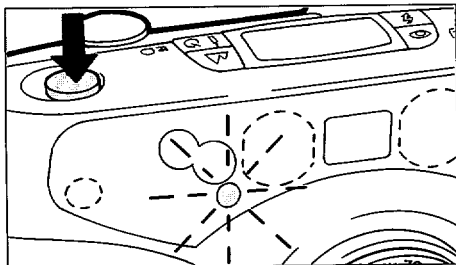

Focus on the subjects first by depressing the shutter release button halfway down, and then depress the shutter release button fully. The shutter will be released in about 10 seconds. When the Self-Timer is working, the Self-Timer symbol (Ⓢ) blinks on the LCD panel, and the Self-Timer lamp lights up. The lamp starts blinking 3 seconds before the shutter is released, letting you know when to smile.

## USING THE WIRELESS REMOTE CONTROL (OPTION)

### Notes on the Self-Timer shooting

- Keep in mind that when starting the Self-Timer while standing in front of the camera, the camera may not focus the subject.
- To cancel the Self-Timer at any time after it's been activated, push the main switch. In this instance, the power will not be turned off.
- When you want to use the flash with the Self-Timer, ensure that the red lamp is lit indicating the flash has been charged before operating the Self-Timer.
- When the Bulb mode is used in combination with the Self-Timer, a shutter speed of approx. 1/2 sec. is automatically selected.

If you have purchased the optional wireless remote control, read this section. The Wireless Remote Control allows you to adjust the focal length in steps of 28, 90, 50, 28 and trip the shutter at a distance.

- Use a tripod when shooting with the Wireless Remote Control.
- When the Remote Control is used to take pictures, the Single-Frame mode can be used in combination with any of the exposure modes. The Self-Timer shooting and the Multi-Exposure modes cannot be used in this case.
- Use the Remote Control to take pictures in the Bulb mode to avoid camera shake. While the Remote Control's shutter release button is held down, the shutter remains open.



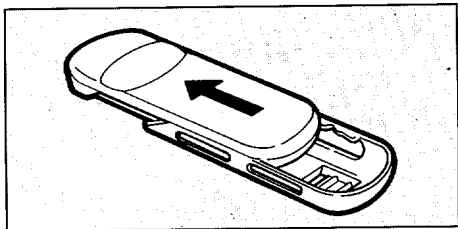



**Removing the Wireless Remote Control**  
Remove the Wireless Remote Control from the Remote Control Holder in the direction of the arrow.

#### Name of parts

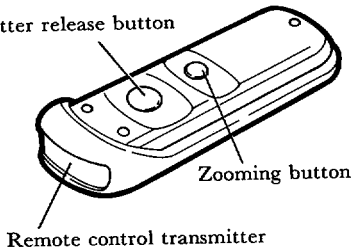
Shutter release button



#### Remote Control Shooting mode

Depress the camera's Drive Button until the (  ) symbol appears on the LCD panel.

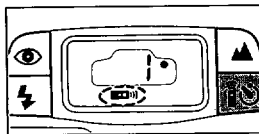

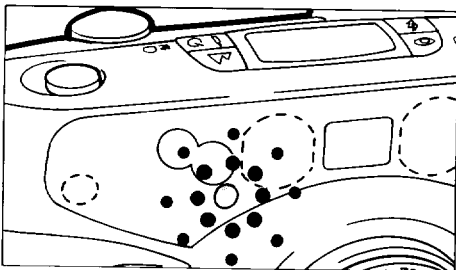

### Blinking Lamp

When the Remote Control Shooting mode is set on the camera, the Self-Timer lamp on the front of the camera blinks slowly, indicating that you can take pictures with the aid of a Remote Control.

When the camera is set in the Remote Control Shooting mode and left unused for 10 minutes, the camera automatically switches itself off to save battery power. Push the camera's Main Switch again to turn it on.

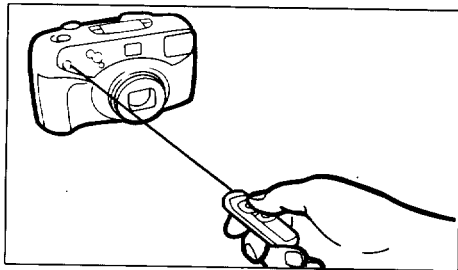

### Taking Pictures

Compose the scene and frame the subject with the AF frame. Aim the Remote Control Transmitter towards the Remote Control Receiver on the camera, and then depress the Remote Control's shutter release button fully to release the shutter.

- The Self-Timer lamp blinks rapidly for 3 seconds and then the shutter is released. If the shutter is released by the camera's release button, pictures will be taken in the ordinary shooting mode.
- Focus cannot be locked when the Remote Control is in use.
- The subject framed in the AF frame will be in focus when the Remote Control's shutter release button is depressed.

### **Operating Distance of the Wireless Remote Control**

**From the camera's front : within approx. 5 m straight in front of the camera**

- The Remote Control may not work in a back-light situation. In this case, use the camera's shutter release button in the Self-Timer mode to take pictures.
- The Remote Control does not work while the built-in flash is being charged.

### **Zooming using the Remote Control**

When the Remote Control Transmitter is aimed towards the camera's Remote Control Receiver, each time you depress the zooming button located on the Remote Control, the lens zooms and stops at steps of 28,90,50 and 28mm focal length settings continuously.

- Before using the Remote Control to zoom the lens, frame the subject through the viewfinder, using the 90mm setting. Otherwise, the subject may be out of the picture area when the lens is zoomed.

### **Battery life on the Remote Control**

About 30,000 commands can be issued using the Remote Control with a battery installed. Have exhausted battery replaced at your local Pentax Service center if the battery is exhausted (there is a charge for this service).

## MULTI-EXPOSURE SHOOTING

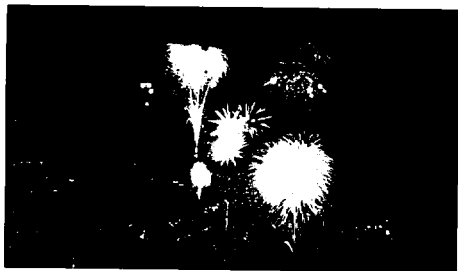

Multi-Exposure mode will disengage the film advance, letting you superimpose images on a single frame for fantastic illusions. Your imagination can produce striking creative effects.

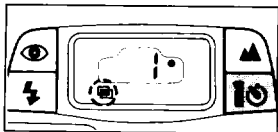

32

### Procedure

1. Depress the Drive Button until the symbol (☐) appears on the LCD panel.
2. Depress the shutter release button to shoot an initial exposure. The film will not advance, the frame counter indication and (☐) blinks on the LCD panel to indicate that you are in the Multi-exposure mode.
3. Recompose the frame, and depress the shutter release button to shoot the second exposure. After the second shot, the film will advance and the Single-Frame shooting mode will be restored.

### Notes :

- To expose or more, depress the drive button until the (☐) remains lit after the step 2 above, and then depress the shutter release button.
- The date will be exposed in step 3 above on the Date model.
- Repeated multiple exposures tend to overexpose a frame, so it is recommended that you expose a frame just twice or 3 times at most.
- When using Multi-Exposure mode, you usually get the best results with dimly-lit background, such as night scenes.

## INFINITY-LANDSCAPE SHOOTING

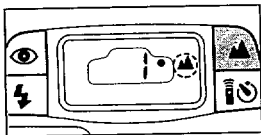

When you wish to take a sharp picture of a distant landscape or a distant subject through a window, the infinity-landscape mode allows you to capture distant scenery with clarity.

Depress the Landscape/Easy PIC. Mode Button until the (▲) symbol appears on the LCD panel.

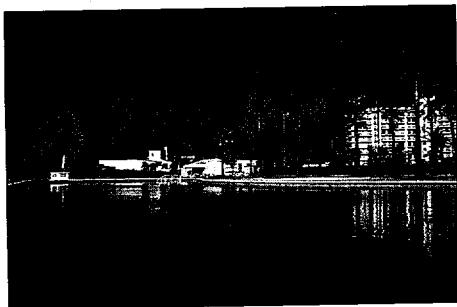

- After the picture is taken by fully depressing the shutter release button, this mode is canceled.
- The flash will not discharge in the Auto exposure mode.

## SPOT AF SHOOTING

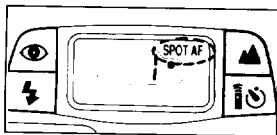

Select the AF spot mode to focus on a particular spot in the frame.

### Switch to Spot AF mode

Depress the Landscape/Easy Pic. mode button so that the (SPOT AF) appears on the LCD panel indicating that you are in the spot AF mode.



### Focus on the subject

Focus on the subject with the Spot AF frame (□) in the center of the viewfinder.

- When the main subject is out of the AF frame in the center of the viewfinder when composing your picture, use the focus-lock technique (See page 36.).
- The lamp indications and picture-taking procedure are similar as explained for multi-beam AF.

## EASY PIC. SHOOTING

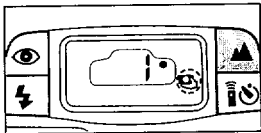

With the "Easy Pic." shooting mode, focus is fixed at 2.9 meter (9.5ft) and the focal length of the lens is also fixed at the 28mm wide-angle position. This provides greater depth of field, and no need to worry about getting out of focus pictures. Please use this mode when you ask someone to take your picture, when shooting quickly, or when close-distance shooting through a window.

1. Depress the Landscape / Easy Pic. Mode Button until the (📷) symbol appears in the LCD panel.

In this mode the 28mm wide-angle focal length of the lens is selected automatically. You are not able to change focal length with the zooming lever. If you move the zooming lever while in this mode, the (📷) symbol starts blinking to warn you.

2. Take a picture by depressing the shutter release button.

This mode sets the lens focus to cover a wide range of approx. 1.2 meter (3.9ft) to infinity under bright sun light. Even with a dark subject you can still obtain proper focus if the subject distance is between approx. 1.8meter (5.9ft) to 8 meter (26.2ft).

If you take a picture with flash please make sure the subject is within the flash effective shooting distance. (See page 19)

The flash effective range of this mode with ISO 100 to 400 film is between 1.8m (5.9ft) to 4.6m (15.1ft).

The lens focal length cannot be changed with the zooming button on the Remote Control when you are in this mode.

To cancel this mode depress the Landscape/ Easy Pic. Mode Button again.

## FOCUS-LOCK SHOOTING

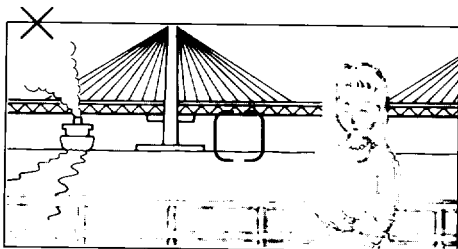

If you shoot without positioning the autofocus frame (□) on the main subject of the illustration as shown above, only the background will be in focus. When the main subject is off the autofocus frame in the center of the viewfinder, use the focus-lock technique.

(Focus lock is the function to lock focus.)

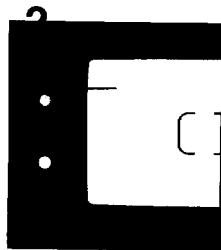
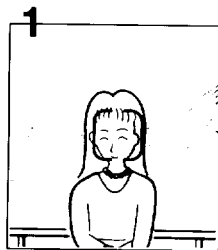

- 1 Focus on the subject with the autofocus frame (□).

When you wish to focus on the face, which appears very small in the viewfinder, focus on the chest instead to fill the focus frame with more of the subject.

- 2 When the shutter release button is depressed halfway down, the green lamp on the left-hand side of the viewfinder lights up and the exposure and focus are temporarily locked.

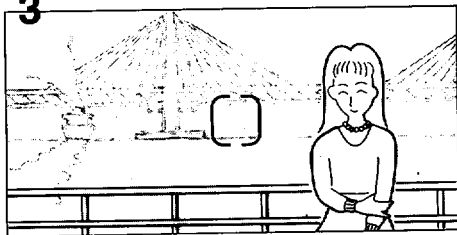

**3**

3 While depressing the shutter release button halfway, re-aim the camera or recompose the picture, then release the shutter.

**Note:**

- You can release focus lock simply by lifting your finger from the shutter release button.

**Hard-to-autofocus subjects**

Like many other autofocus cameras, the camera's autofocus system is highly precise, but not perfect. Some subjects may not be focused as you wish. In such a case, use the focus-lock technique on a subject near the actual one and equidistant from the lens. Subjects which may fool the system include :

1. Black objects like hair, which don't reflect much light (and therefore don't reflect infrared autofocus beams).
2. Wire netting, latticework, iron exercise-bars, etc.
3. Flickering light sources such as neon signs, fluorescent lamps, TV images, sunlight coming through trees, etc. and subjects illuminated by these light sources.
4. Glossy and reflective surfaces like glass, mirrors, car bodies, etc.
5. Fast-moving objects, like trains or automobiles in motion.
6. Water jets, water surface, smoke, flame, fireworks, etc., which have no distinct or consistent form, or a subject in mist.

## EXPOSURE COMPENSATION

Exposure compensation is an adjustment to brighten or darken the whole picture when shot in high-contrast lighting conditions. Use the “+” side for situations with bright backgrounds or the “-” side for situations where the central subject is too brightly lit from the front. Exposure compensation is possible in the range from +3EV to -3EV in 0.5EV step. This compensation can be used in combination with the various exposure setting.

- Exposure compensation does not work in the Bulb or Bulb-Synch mode.
- Confirm the compensation value, hold down the Red-eye reduction button for approx. 2 seconds.
- Once the exposure compensation is set, the compensation value will be stored in memory until the film is replaced. To cancel exposure correction, reset the corrected value to  $\pm 0$ .

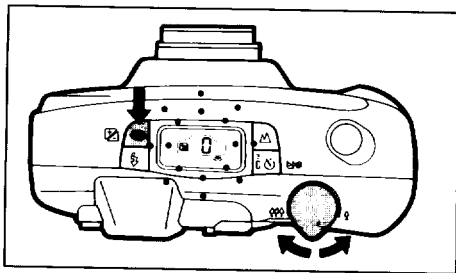

### Setting the exposure compensation

Hold down the Red-eye reduction flash button for about 2 seconds to make the exposure compensation mark (☒), (☑) and (☓) blink. While holding down the Red-eye reduction flash button, move the zooming lever to the right or the left until the desired compensation value appears. Holding the zooming lever fully to the right or the left will advance the digit continuously. After the compensation value has been entered, the compensation mark (☒) or (☑) appears on the LCD panel even if the lever is released, indicating that the exposure compensation is activated.

## TAKING PANORAMIC FORMAT PICTURE

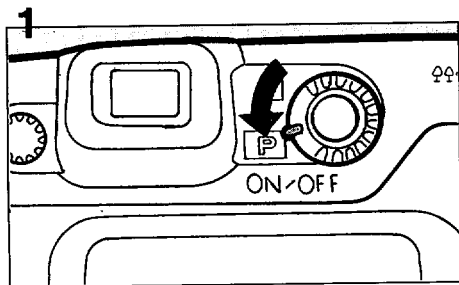

You can switch between the panoramic format and standard format picture taking mode in the middle of the roll by moving the panorama mode switch. The panoramic format picture allows horizontally positioned dynamic pictures to be taken (13×36mm on film).

### 1 Switching to the panoramic format picture

Move the panorama mode selector switch to (P) to select the panoramic format mode.

- When the format is switched to panorama, the viewfinder switches to the horizontal panoramic format frame.

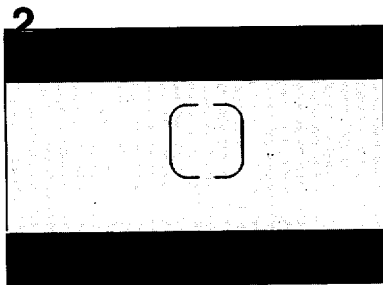

### 2 Taking a panoramic format picture

Compose the scene within the panoramic format frame, and then fully depress the shutter release button to take a panoramic format picture.

- When the camera-to-subject distance is less than 1m, panoramic format photography is not recommended due to a substantial difference between what you see through the viewfinder versus the image you will obtain the actual picture taking area ; otherwise known as parallax.



The mark “—” indicates the position where the date and time are imprinted.

The DATE MODEL allows you to record DATE information in the panoramic mode in a similar manner to the standard picture taking mode. See “DATE MODEL” on page 42 for details. The dating unit automatically switches the DATE position between the standard and panorama according to the format mode selected.

### NOTES ON THE DEVELOPMENT OF PANORAMIC FORMAT PICTURES

- When developing the film, if you have taken only panoramic format pictures on the entire roll of film, tell the clerk at the processing lab to develop the film with only the panoramic format. If there are both panoramic and standard format photographs on the film, ask the clerk to develop the film with both standard and panoramic format.

- The development of panoramic format pictures is a more time-consuming and expensive process than that of standard pictures. Please consult the processing lab for more details.
- Panoramic format processing facilities differ depending on the area and requirements. Your local film processor or camera dealers will advise you on all the options available to you.
- With panoramic format pictures, only the middle area of the frame is exposed. The number of exposures available in the panoramic format is equivalent to that of the standard photo size.
- When the panoramic format picture is printed with a standard size format, the black cropped areas will appear on the top and bottom of the picture.

## DATE MODEL

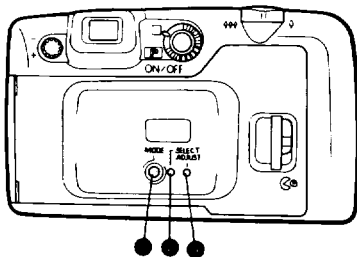

If you purchased the DATE model, read this section. The DATE model records dates up to the year 2019 on pictures.

- ① **MODE** Mode button
- ② **SELECT** Select button
- ③ **ADJUST** Adjust button

### Switching the Mode

At each press of the Mode button ① with your fingernail, the mode on the LCD panel switches as shown in the chart.

### Notes :

“---” indicates no data will be imprinted.

- “M” on the LCD panel indicates “Month”.
- Use the strap cramp’s protrusion to depress the Select and Adjust buttons.

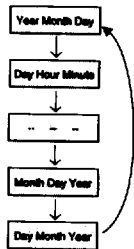

\*The date in the picture above is simulated.

### Correcting the date

1. Depress the Select button ② to make a different category of digits on the LCD panel you want to change blink.
2. Depress the Adjust button ③ to change digits of the specified category you chose with the Select button ②. Digits increase by one each time you depress the Adjust button ③. Holding down the button will advance digits continuously.
  - The blinking “ : ” allows precise fine-tuning of the internal clock to the beginning of a specified minute. To do so, depress the Select button ② to make the “ : ” blink, and then depress the Adjust button ③ in sync with a time signal.
3. After the data has been adjusted, depress the Select button. The bar mark (—) appears on the LCD panel, indicating that data imprinting choices are possible.
  - If you release the shutter while the blinking data is being corrected, the data cannot be imprinted.
  - Numerical indication
    - Year = 87-19 (1987-2019)
    - Month = 1-12
    - Day = 1-31
    - Time = 0-23
    - Minute = 00-59

### OPERATIONAL PRECAUTIONS

The data on the LCD panel is imprinted on each frame you expose.

- “Year-Month-Day” and “Day-Hour-Minute” cannot be imprinted at the same time.
- As you release the shutter, the bar (—) mark on the display blinks for a few seconds, indicating the data has been imprinted.
- Move the panorama mode selector lever to the right or left to switch the imprint mode between panorama and standard.
- The dating unit automatically switches the imprint mode between the standard and panorama according to the format mode selected.
- If there is a white or yellow object in the corner of the picture where the data is imprinted, the data may be difficult to read. When composing your photographs, try to avoid brightly-colored subjects in that corner.

## BATTERY EXHAUSTION WARNING

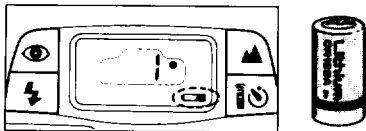

When the battery is nearly exhausted, the battery symbol (⚡) appears on the LCD panel to warn you. Replace the battery as soon as possible. When (⚡) starts blinking, no operations can be performed.

**Battery life (using 24-exposure film rolls)**  
: Approx. 15 rolls Using flash 50% of the time (using the CR123A battery and under Pentax testing conditions)

(The CR123A battery was used under Pentax testing conditions. Actual battery life/performance may vary drastically depending on usage of Auto-Focus, Power Zoom, Flash, and external conditions such as temperature and freshness of the battery.)

### Notes on replacing the battery :

- Ensure that there is no film loaded. Switch off power before replacing the battery.
- If the battery is replaced with a film already loaded, the camera enters the starting mode. It will assume the film has just been loaded and will advance several frames. "J" will appear on the LCD panel.
- If the battery is replaced at the end of the film roll, the camera may not detect the film end, and the frame counter indication may not appear on the LCD panel. Follow the procedure for rewinding the film in mid-roll to rewind the film, and remove the film.
- The battery is used by both the camera body and the date function on the DATE model to keep constant track of time. After the battery is replaced, correct the time and date. (See page 43.)
- When the camera is in a carrying bag, ensure the Main Switch is off : otherwise, battery power may be wasted if the shutter release button is accidentally pushed.



## INSTALLING/REPLACING BATTERY Use one 3V lithium battery (CR-123A or the equivalent)

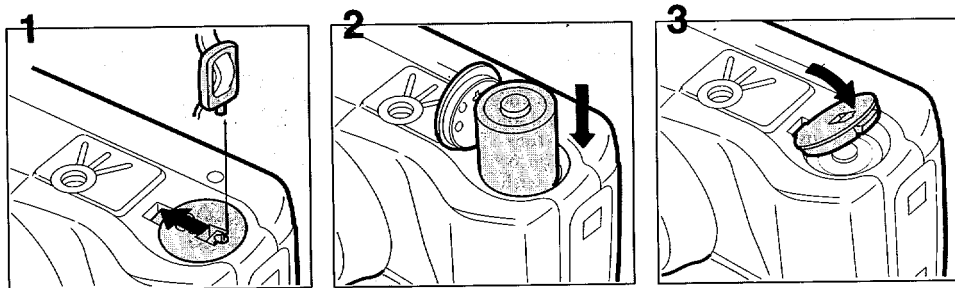

Ensure that the power is off before replacing the battery.

1. Open the battery chamber cover by pulling the cover lock in the direction of the arrow with the strap clamp's protrusion.
2. Insert one lithium battery with the plus/minus (+/-) sides matching the indications in the battery compartment.

3. Close the battery chamber cover. Ensure that the cover is locked with a click.
  - If the battery is correctly loaded, the zoom lens moves slightly and the motor operates for a few seconds.
  - On the **DATE MODEL**, the date is initialized to 87/1/1 when the battery chamber cover is opened.

## TAKING CARE OF YOUR CAMERA

**Your Pentax camera is a sophisticated, high-precision, and reliable mechanism. Handle it with great care.**

- Do not use the camera in a place where the camera may come in contact with rain or water because the camera is not weather-resistant. Should the camera get wet rain or splashing water, wipe it off immediately with a dry soft cloth.
- Do not drop the camera or allow it to hit a solid object. If the camera suffers a severe shock or impact, take it to a Pentax service center for inspection.
- Be careful not to subject the product to strong vibrations, shock or pressure. Use a cushion to protect the camera when carrying it in a motorcycle, car, boat, etc.
- Use a blower and lens brush to remove dust accumulated on the lens or viewfinder.
- Do not store the camera in a closet with mothballs or in a case where chemicals are handled. Store it in a place with good air circulation to prevent fungus growth.
- Avoid leaving the camera for extended periods in places where temperature and humidity are high, such as in a car.

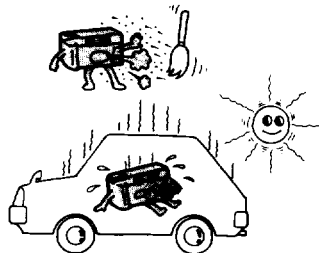

- Condensation on the interior or the exterior of the camera may be extremely harmful to the camera mechanism as it may cause rust and/or corrosion. Furthermore, if the camera is taken from warm temperature to a subfreezing one or vice versa, the formation of icelets may cause damage. In such a case, put the camera into a case or plastic bag so that any changes in temperature will be as gradual as possible. After the temperature difference is minimized, take it out of the bag.
- The temperature range at which this camera function properly is  $50^{\circ}\text{C}$  to  $-10^{\circ}\text{C}$  ( $122^{\circ}\text{F}$  to  $14^{\circ}\text{F}$ ).

- Electrical problems may often be caused by water, dirt or dust at points of electrical contact. Also check for battery leakage, traces of dirt or grease, or corrosion due to salinity or gas. If you cannot correct the problem, have your camera inspected at a Pentax service center. Repair of damage of any kind are not covered under the terms of the warranty and charges may be assessed.
- Do not apply force to the zoom lens as doing so causes damage to the camera. Never place the zoom lens with the front side facing downward.
- Regular size color prints may cut off what appears on the extreme edges of the film frame. Compose your picture with a margin of safety at the edges.
- To maintain optimum performance, a camera which has not been used for an extended period, or is being prepared for an important photographic session, it is recommended that you have the camera inspected or test shoot with it.
- Repairs made necessary due to usage of this product in an industrial or commercial application may not be covered under the terms of the Pentax warranty.

### **Red-eye phenomenon in flash photography**

When a picture is taken using a flash, a subject's eyes may appear red in the print. This phenomenon is caused by the reflection of the electronic flash in the retina. It can be reduced when the surroundings of the subject are brightened, or shooting distance is shortened or by employing the red-eye reduction flash feature.

## TROUBLESHOOTING

What appears troublesome may be easily remedied. Here are some problems that may occur and their remedies.

Symptoms	Causes and Remedies
1.The shutter cannot be released.	<ul style="list-style-type: none"><li>• Is the main switch turned off? If so, turn it on. (See page 7.)</li><li>• Is the battery exhausted? Replace it or insert new battery if it is exhausted. (See page 44.)</li><li>• Is (0) blinking on the LCD panel? If so, the film has been used up. Insert a new roll. (See page 20.)</li></ul>
2.My printed pictures don't look very clear.	<ul style="list-style-type: none"><li>• Did you position the autofocus frame on your subject? (See page 18.)</li><li>• Did you obstruct the autofocus window with your fingers, hair or other object when you depressed the shutter release button? (See page 9.)</li></ul>
3.Zoom lens retracted automatically (the power is turned off automatically).	<ul style="list-style-type: none"><li>• Did you leave the camera unused for over 3 minutes after the main switch was turned on? The power is automatically switched off if the camera is left unused for over 3 minutes. (See page 8.)</li><li>• When the camera is on and left unused for more than 10 minutes in the Remote Control shooting mode, the camera automatically switches itself off to save battery power. Push the main switch again to turn it on (See page 30.)</li></ul>

Symptoms	Causes and Remedies
4. The Remote Control does not operate.	<ul style="list-style-type: none"> <li>• The operable distance of the Remote Control is approx. 5m from the front. (See page 31.)</li> <li>• The Remote Control may not operate in a backlight situation. (See page 31.)</li> <li>• The flash is being charged. Wait until it fully charges. (See page 31.)</li> <li>• With Easy Pic. shooting mode unable to operate zooming by the Remote Control. (See page 35.)</li> </ul>
5. Zoom lens does not move.	<ul style="list-style-type: none"> <li>• With Easy Pic. shooting mode unable to operate zooming by the zooming lever. (See page 35)</li> </ul>
6. The ( H ) or ( U ) mark is displayed on the LCD panel.	<ul style="list-style-type: none"> <li>• If either mark disappears when the zoom lever is moved, the camera is ready for use. The camera may be defective if either mark appears often.</li> </ul>



The correct camera-to-subject distances when shooting using flash with films other than ISO 100, 200 or 400 are indicated in the table below.

Lens	ISO	25	50	1000	1600	3200
28mm (◆◆◆)		0.58-2.5m	0.58-3.5m	1.0*-16.5m	1.3*-21.0m	1.8*-30.0m
90mm (◆)		0.58-1.2m	0.58-1.7m	0.58-8.0m	0.58 -10.0m	0.6*-14.2m

\*With high speed film, overexposure may occur at close range due to the film's high speed.

## SPECIFICATIONS

<b>Type :</b>	35mm fully automatic leaf-shutter camera with built-in zoom lens and auto flash
<b>Film :</b>	Auto film speed setting with 35mm perforated DX-coded film with ISO rating from 25 to 3200 (1EV step). Non-DX coded films are automatically set to ISO25
<b>Format :</b>	24×36mm (13×36 in panoramic format)
<b>Film loading, :</b>	Auto film loading Closing the back cover will automatically wind the film to first exposure
<b>Film winding :</b>	Auto film-winding : single-frame advance mode.
<b>Film rewinding :</b>	Auto start at the end of roll. Auto stop upon completion of rewinding. Rewinding time : approx 20 sec. with 24-exposure film. Rewinding in mid-roll provided.
<b>Frame number :</b>	Automatic readout of successive frame numbers in ascending order when shooting, and descending order when rewinding.
<b>Lens :</b>	Pentax power zoom 28-90mm f/3.5-9 9 elements in 7 groups, Angle of view : 75° - 27°.
<b>Focusing system :</b>	Pentax infrared active Multi-beam autofocus with focus lock. Switchable to Spot AF mode. Range : 0.58m (1.9ft) -infinity (Maximum magnification approx. 1/5.8X). Infinity-landscape mode (focus is fixed to infinity), Easy Pic. mode (focus is fixed at 2.9m).
<b>Zooming :</b>	Electronic zoom
<b>Shutter :</b>	Programmed AE electronic shutter with speeds approx. 1/400sec. -1/5 sec. Bulb : 1/2 sec.-10 min., Electromagnetic release
<b>Self timer :</b>	Electronic red lamp indication. Approx. 10- sec. delay with LED indication. Cancellation after activation is possible.
<b>Viewfinder :</b>	Actual image zoom viewfinder : 83% field-of-view ratio, Magnification : approx. 0.32X (28mm) -0.94X (90mm), Diopter : -2.5 - +0.5D, AF frame, Picture frame, Close distance compensation frame, Panoramic format picture area, Green lamp lighting : in-focus signal, Green lamp blinking : close-distance warning, Red lamp lighting : Flash-ready status, Red lamp blinking : Flash being charged.
<b>Exposure control :</b>	Programmed auto-exposure control. Range : EV8.6-17 at 28mm, EV11.6-17 at 90 mm in Auto or Daylight-Synchro mode (ISO 100), EV 6.0-17 in 28 mm, EV8.4-17 at 90mm in Slow-Shutter-Speed mode. Automatic exposure compensation in a backlit situation.

- Exposure compensation :**  $\pm 3EV$  (0.5EV step)
- Exposure-meter switch :** The exposure meter is turned on by half depression of the shutter release button.
- Flash :** Built-in zoom flash with red-eye reduction mode, Automatic flash emission in low-luminance or a backlight situation, Flash-ON = Daylight-Synchro / Slow-Shutter-Speed Synchro (up to 1/5 sec.), Flash-OFF = Flash override, Bulb-Synchro = 1/2 sec.-10 min.
- Flash effective range :** 0.58-5.0m (28mm), 0.58-2.4m (90mm), (ISO100 film used)
- Flash recycling time :** Approx. 5 sec. under Pentax testing conditinos
- Remote control :** Infrared wireless remote control, Step zooming at 28mm, 90mm, 50mm and 28mm, Effective range : 5m from the front when projected from the camera's front.
- Power source for Remote control :** One lithium battery CR1620 (replaced by the Pentax Service facility)
- Size & weight for Remote Control :** 23.5 (W)  $\times$  68.5 (L)  $\times$  15.0 (D), 0.9"  $\times$  2.7"  $\times$  0.6", 15g (0.5oz)
- Power source :** One 3V lithium battery (CR123A or the equivalent)
- Battery life :** Approx. 15 rolls of 24 exposure film when 50% of shooting uses flash (under Pentax testing conditions)
- Battery exhaustion warning :** (  ) appears on the LCD panel, Shutter is locked when the (  ) is blinking
- Data mechanism :** Crystal quartz controlled ; LCD with digital clock, auto calendar
- Imprinting mode :** "Year, Month and Day", "Day, Hour and Minute" or blank
- Size & weight :** 126.5 (W)  $\times$  73 (H)  $\times$  54.5 (D) (5.0"  $\times$  2.9"  $\times$  2.1") 305 grams, (10.8oz.) (without battery)
- DATE model :** 126.5 (W)  $\times$  73 (H)  $\times$  57.5 (D) (5.0"  $\times$  2.9"  $\times$  2.3") 315 grams, (11.1oz.) (without battery)

**SPECIFICATIONS ARE SUBJECT TO CHANGE AT ANY TIME WITEOUT NOTIFICATION OR ANY OBLIGATION ON THE PART OF THE MANUFACTURER.**

## WARRANTY POLICY

All Pentax cameras purchased through authorized bona fide photographic distribution channels are guaranteed against defects of material or workmanship for a period of twelve months from date of purchase. Service will be rendered, and defective parts will be replaced without cost to you within that period, provided the equipment does not show evidence of impact, sand or liquid damage, mishandling, tampering, battery or chemical corrosion, operation contrary to operating instructions, or modification by an unauthorized repair shop. The manufacturer or its authorized representatives shall not be liable for any repair or alterations except those made with its written consent and shall not be liable for damages from delay or loss of use or from other indirect or consequential damages of any kind, whether caused by defective material or workmanship or otherwise ; and it is expressly agreed that the liability of the manufacturer or its representatives under all guarantees or warranties, whether expressed or implied, is strictly limited to the replacement of parts as hereinbefore provided. No refunds will be made on repairs performed by non-authorized Pentax service facilities.

### **Procedure During 12-month Warranty Period**

Any Pentax which proves defective during the 12-month warranty period should be returned to the dealer from whom you purchased the equipment or to the manufacturer. If there is no representative of the manufacturer in your country, send the equipment to the manufacturer, with postage prepaid. In this case, it will take a considerable length of time before the equipment can be returned to you owing to the complicated customs procedures required. If the equipment is covered by warranty, repairs will be made and parts replaced free of charge, and the equipment will be returned to you upon completion of servicing. If the equipment is not covered by warranty, regular charges of the manufacturer or of its representatives will apply. Shipping charges are to be borne by the owner. If your Pentax was purchased outside of the country where you wish to have it serviced during the warranty period, regular handling and servicing fees may be charged by the manufacturer's representatives in that country. Notwithstanding this, your Pentax returned to the manufacturer will be serviced free of charge according to this procedure and warranty policy.



In any case, however, shipping charges and customs clearance fees are to be borne by the sender. To prove the date of your purchase when required, please keep the receipts or bills covering the purchase of your equipment for at least a year. Before sending your equipment for servicing, please make sure that you are sending it to the manufacture's authorized representatives or their approved repair shops, unless you are sending it directly to the manufacturer. Always obtain a quotation for the service charge, and only after you accept the quoted service charge, instruct the service station to proceed with the servicing.

**The local warranty policies available from Pentax distributors in some countries can supersede this warranty policy. Therefore, we recommend that you review the warranty card supplied with your product at the time of purchase, or contact the PENTAX distributor in your country for more information and to receive a copy of the warranty policy.**

#### **STATEMENT OF FCC COMPLIANCE**

This device complies with Part 15 of the FCC Rules. Operation is subject to the following two conditions : (1) This device may not cause harmful interference, and (2) this device must accept any interference received, including interference that may cause undesired operation.

Changes or modifications not approved by the party responsible for compliance could void the user's authority to operate the equipment. This equipment has been tested and found to comply with the limits for a Class B digital device, pursuant to part 15 of the FCC Rules. These limits are designed to provide reasonable protection against harmful interference in a residential installation. This equipment generates, uses and can radiate radio frequency energy and, if not installed and used in accordance with the instructions, may cause harmful interference to radio communications. However, there is no guarantee that interference will not occur in a particular installation. If this equipment does cause harmful interference to radio or television reception, which can be determined by turning the equipment off and on, the user is encouraged to try to correct the interference by one or more of the following measures :

- Reorient or relocate the receiving antenna.
- Increase the separation between the equipment and receiver.
- Consult the dealer or an experienced radio/TV technician for help.

This Class B digital apparatus meets all requirements of the Canadian Interference-Causing Equipment Regulations.

## NAMES OF WORKING PARTS

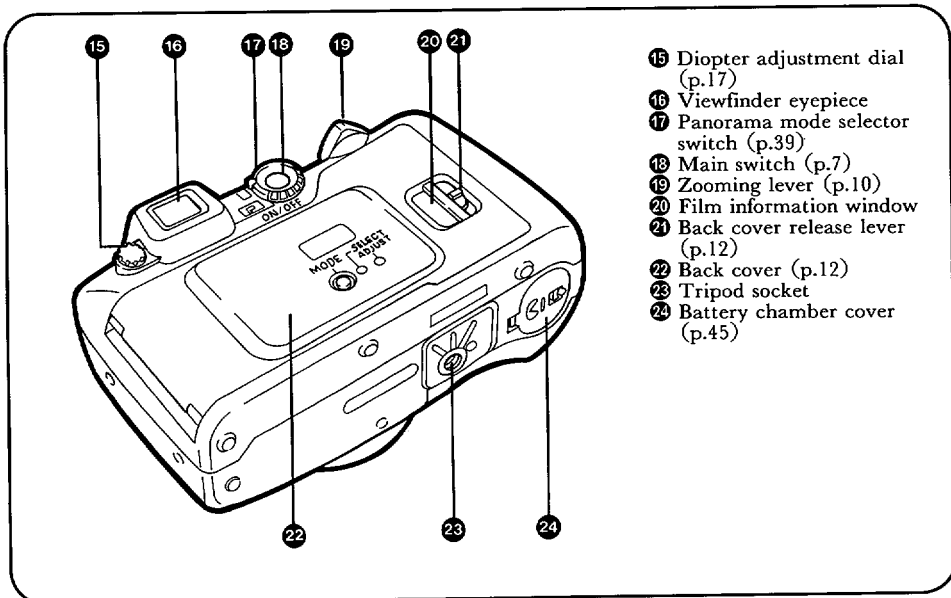

## LCD PANEL

All indications will not actually appears simultaneously as shown.

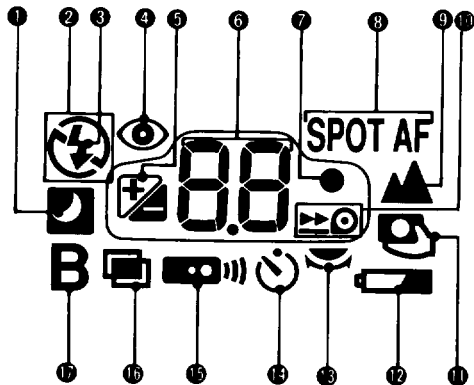

- 1 Slow-Speed-Shutter (p.25)
- 2 Flash OFF (p.25)
- 3 Flash ON (p.24)
- 4 Red-eye Reduction Flash mode (p.22)
- 5 Exposure Compensation (p.38)
- 6 Exposure Counter (p.13)
- 7 Shutter Release button
- 8 Spot AF mode (p.34)
- 9 Infinity-Landscape mode (p.33)
- 10 Film Rewinding mode (p.20)
- 11 Easy. Pic. mode (p.35)
- 12 Battery Exhaustion Warning (p.44)
- 13 Zooming lever (p.10)
- 14 Self-Timer mode (p.27)
- 15 Remote Control Shooting mode (p.28)
- 16 Multi-Exposure Shooting mode (p.32)
- 17 Bulb (p.26)

### LCD (Liquid-crystal display)

- When the LCD is exposed to high temperatures over about 60°C, it may blacken, but when the temperature normalizes, it will return to normal.
- The LCD may also slow down in response to lower temperatures, but this is a normal characteristic of an LCD.



**Asahi Optical Co., Ltd.** 11-1, Nagata-cho 1-chome, Chiyoda-ku, Tokyo 100, JAPAN

**Pentax Europe n.v.** Weiveldlaan 3-5, 1930 Zaventem, BELGIUM

**Pentax GmbH.** Julius-Vosseler-Strasse, 104, D-22527 Hamburg, GERMANY

**Pentax U.K. Limited.** Pentax House, Heron Drive, Langley, Slough SL3 8PN, U.K.

**Pentax France S.A. Z.I.** Argenteuil, 12, rue Ambroise Croizat, 95100 Argenteuil, FRANCE

**Pentax Benelux B.V.** (for Netherlands) Spinveld 25, 4815 HR Breda, NETHERLANDS

(for Belgium & Luxemburg) Weiveldlaan 3-5, 1930 Zaventem, BELGIUM

**Pentax (Schweiz) AG** Industriestrasse 2, 8305 Dietlikon, SWITZERLAND

**Pentax Scandinavia AB** Falhagsleden 57, 75127 Uppsala, SWEDEN

**Pentax Corporation** 35 Inverness Drive East, Englewood, Colorado 80112, U.S.A.

**Pentax Canada Inc.** 3131 Universal Drive, Mississauga, Ontario L4X 2E5, CANADA

## Free Manuals Download Website

<http://myh66.com>

<http://usermanuals.us>

<http://www.somanuals.com>

<http://www.4manuals.cc>

<http://www.manual-lib.com>

<http://www.404manual.com>

<http://www.luxmanual.com>

<http://aubethermostatmanual.com>

Golf course search by state

<http://golfingnear.com>

Email search by domain

<http://emailbydomain.com>

Auto manuals search

<http://auto.somanuals.com>

TV manuals search

<http://tv.somanuals.com>