

# PENTAX®

**IQZ<sub>oom</sub>60**

**IQZ<sub>oom</sub>60<sub>DATE</sub>**

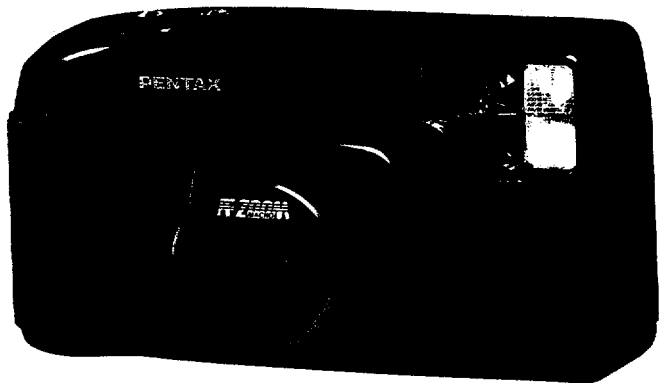

**OPERATING MANUAL**

Welcome to the world of Pentax zoom compact photography! Your compact, lightweight camera is a great companion to take along anytime, anywhere to preserve the best of your memories. With the built-in 38 ~ 60mm zoom lens, it gives you freedom to frame an image the way you like it – from a breath-taking landscape to a family portrait, and even a detailed close-up. And the built-in auto flash helps you capture night and indoor scenes with clarity and brilliance. Since most of the operations – from film handling to focus and exposure controls – are automatic, you can have great pictures without the work.

Before you start using the camera, read this operating manual very carefully to learn how to take flawless pictures all the time.

## CONTENTS

Battery insertion and check .....	4
Film .....	6
Film loading .....	7
Viewfinder indications and shooting ranges .....	10
Green/red lamps and mode switch button .....	11
Operating 38 ~ 60mm zoom lens .....	12
Taking ordinary pictures .....	13
Flash photography .....	14
Unloading film .....	17
Taking macro (close-up) pictures .....	18
Focus-lock shooting (FL).....	20
Fitting strap; soft case .....	22
Battery .....	24
DATE model .....	25
Taking care of your camera .....	28
How to hold camera .....	29
Specifications .....	30
Warranty policy .....	32

## MAIN SWITCH, MODE SWITCH BUTTON AND LCD PANEL'S DISPLAYS

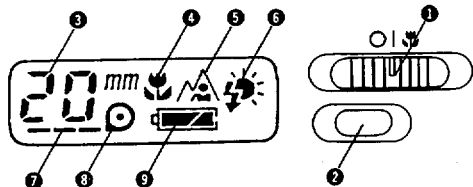

- 1 Main switch:** For the ordinary shooting, set it at [ | ], and at [ ♡ ] for the macro shooting.
- 2 Mode switch button:** For switching the flash to the ordinary-shooting (also auto-flash) or daylight-sync flash mode.
- 3 Exposure counter/Focal-length indication:** Indicates the number of the frames exposed and the focal length of the lens in use.
- 4 Macro mark:** Indicates you are taking a close-up picture.
- 5 Ordinary-shooting mark:** Indicates the camera is set in the ordinary-shooting mode in which the flash automatically fires when the subject is dark.
- 6 Daylight-sync mark:** Indicates that the flash fires automatically regardless of the subject's brightness.
- 7 Film-transport mark:** Indicates the film is advancing or being rewound.
- 8 Cartridge mark:** Indicates the film is loaded.
- 9 Battery mark:** Indicates how good the battery is.

## NAMES OF WORKING PARTS

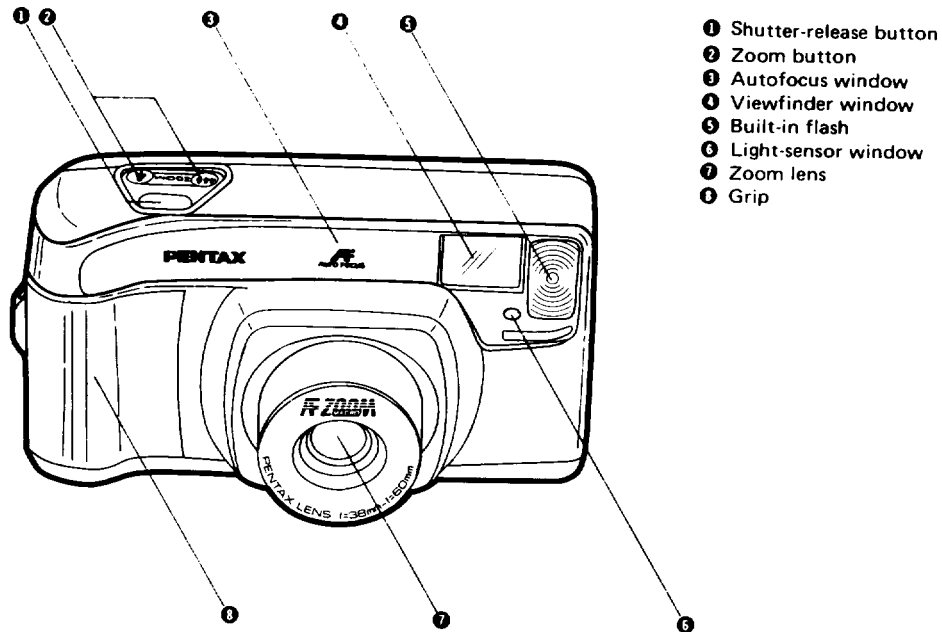

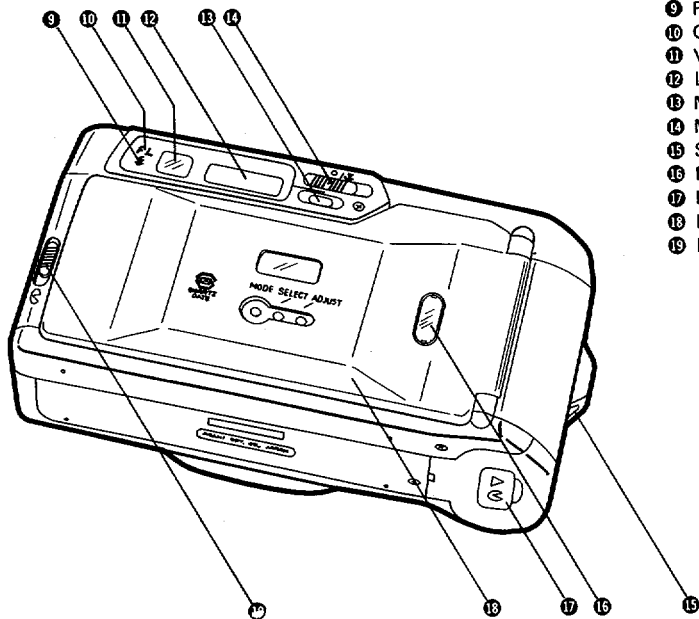

- 9 Red lamp
- 10 Green lamp
- 11 Viewfinder eyepiece
- 12 LCD panel
- 13 Mode switch button
- 14 Main switch
- 15 Strap lug
- 16 Film information window
- 17 Battery chamber cover
- 18 Back cover
- 19 Back-cover-release lever

## BATTERY INSERTION AND CHECK

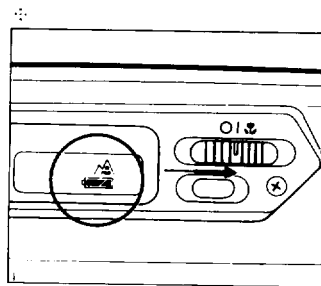
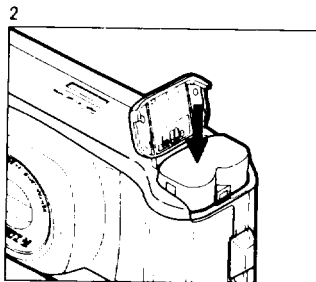
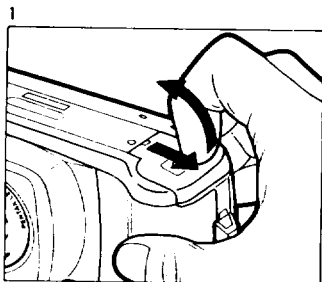

### Inserting the battery

- Before doing this, make sure the film is not loaded in the camera, and that the main switch is turned off.

1. Open the battery-chamber cover by sliding it in the direction of the arrow.
2. Insert any one of the following 6V lithium batteries into the chamber with its contact side down. Close the cover by sliding it back in place while pressing it.





Duracell DL-223A,  
Panasonic/National CR-P2

### ❖ Battery check

When the battery mark [  ] appears in the LCD panel as you turn the main switch on by setting it at [ I ], the battery is alive.

- As you set the main switch at [ I ], the lens cover automatically opens and the lens extends slightly.
- The lens cover also automatically closes as you set the switch at [ I ]. Do not open or close it manually.

### Battery capacity

- ①  = indicates the battery is alive.
- ↓
- ②  = indicates the battery voltage is going down.
- ↓
- ③  =
- ↓
- ④  = indicates the battery is dead.  
(flickering)

### Replacing the battery

Before shooting, be sure to check which battery mark appears in the LCD panel. When the ④ mark appears, you must replace the battery immediately, but even when the ② or ③ mark appears, you had better replace it as soon as possible. Since the data-imprinting unit is also powered by this battery, do not fail to adjust the data-display after replacing the battery.

### When the battery is exhausted

Since the data-recording unit and the exposure counter work properly even if the battery is exhausted, do not remove the battery from the camera until you replace it with a new one.

If you replace the battery during shooting, about four frames of the film may be wound and the exposure counter may return to the first frame. Also, the date display may change to [8? : ?]. Should these happen, adjust them before you start shooting.

**The shutter cannot be released in the following cases:**

- When the battery is not loaded, when it is exhausted, or when it is not properly loaded.
- When the main switch is off.
- When the camera-to-subject distance is less than one meter (3.3 ft.) in the ordinary shooting.
- When the flash is being charged, and when the flash's recycle time gets extremely long.

## FILM

### DX FILM

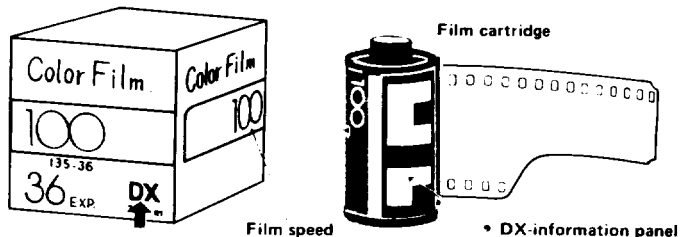

This camera is designed to use DX-coded film with an ISO rating from 50 to 1600, and when such film is loaded, its film speed is automatically set in the camera.

- When buying DX film, make sure the package bears the "DX" mark or that the cartridge has a DX-information panel.

- If non-DX film is loaded by mistake, the film speed is automatically set to ISO 100, no matter what the film speed is.

- Use high-speed film with an ISO rating of 1000, 1600, etc. for shooting indoors or in a dimly-lit place.



## FILM LOADING

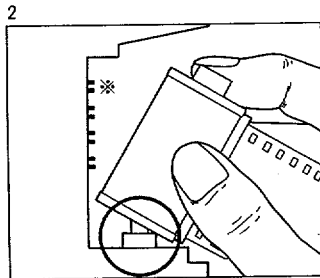
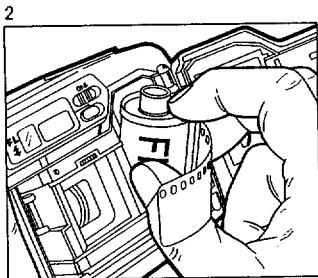
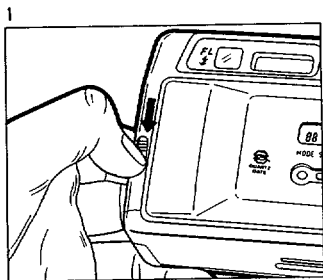

1. Open the back cover by sliding the back cover release lever in the direction of the arrow. (Turn the main switch off.)
2. Place the film cartridge into the film chamber by first fitting its flat side on the top of the rewind shaft.

● Be sure to load or unload the film in a shady spot, or shield the camera and film from direct sunlight with your body. While doing this, take care not to put dust, stains, etc. on the lens.

※ Do not bend these DX-information pins, and keep them free from dirt, dust or scratches.

3

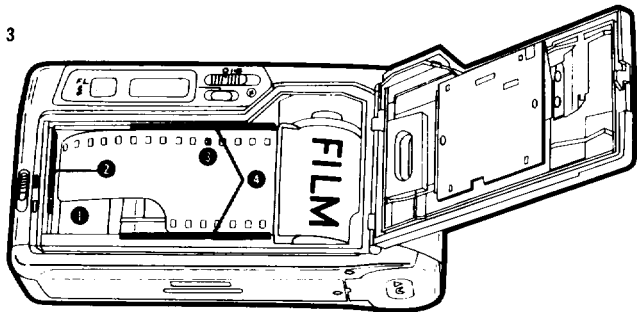

3. Pull the film leader out far enough to reach the film roller ①. Align the tip with the film leader end mark ②.

- Make sure the film perforations properly engage the sprocket teeth ③.
- Also make sure the film is properly placed between the guide rails ④.

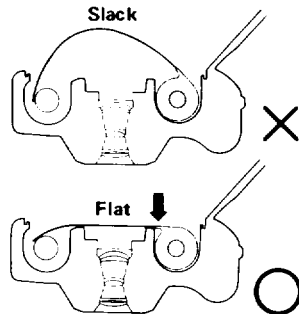

- Make sure the film is taut as illustrated. If there is any slack left in the film, take it up by pushing the film back into the cartridge.
- If the film leader end is extremely bent, straighten it or cut off the bent portion.

8

4

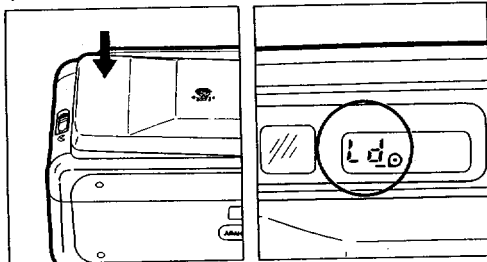

4. Close the back cover. The letters "Ld" (Loading) will then appear in the LCD panel.

● If "Ld" (Loading) indication does not appear in the LCD panel, or when the exposure counter does not indicate "1" even with the main switch turned on [ I ], the film is not properly loaded in the camera. Reload the film.

5

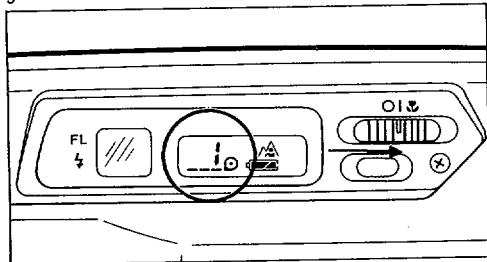

5. As you turn the main switch on by setting it at [ I ], the film automatically advances to the first frame, making the exposure counter indicate "1" in the LCD panel.

● Wherever the main switch is set, the film automatically advances to the first frame.  
 ● When the main switch is set at [ I ], the film advances to the first frame even if you press the shutter button.

## VIEWFINDER INDICATIONS AND SHOOTING RANGES

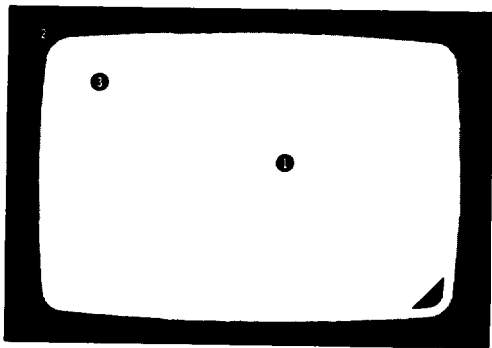

- 1 **Autofocus frame**  
Bring this frame on what you want to focus.
- 2 **Picture-area frame**  
This is the area in which you should compose a macro (close-up) or an ordinary photograph.
- 3 **Parallax-correction frame**  
When taking a close-up picture of the subject 0.6 meters (2 ft.) or so away, or an ordinary picture of the subject one meter (3.3 ft.) or so away, compose the picture within this frame.

← Part of the lens front is seen through the viewfinder when the lens is set at the wide-angle position, but it is not recorded on film.

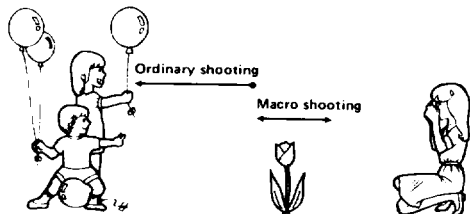

### Shooting ranges (Effective camera-to-subject distance)

- The ordinary shooting ranges from  $\infty$  (infinity) to one meter (3.3 ft.)
- The macro shooting ranges from one meter (3.3 ft.) to 0.54 (1.8 ft.). No subject closer than 0.54 meters (1.8 ft.) can be photographed.

## GREEN/RED LAMPS AND MODE SWITCH BUTTON

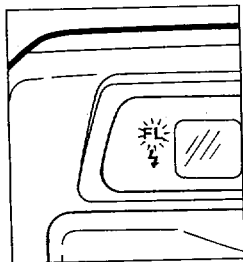
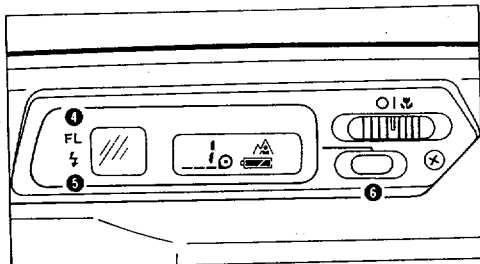
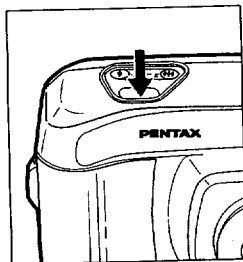

As you press the shutter button half-way, the lamp ④ and ⑤ shown above glow or flicker.

**④ Green lamp**

When it glows, you can take a picture.  
When it flickers, you cannot.

**⑤ Red lamp**

When it glows, flash is ready to fire.  
When it flickers, flash is being charged.

- When the green lamp flickers in the ordinary or macro shooting, it indicates the subject is too close to the camera. Adjust the camera-to-subject distance so that the green lamp glows, and then release the shutter. (When the distance is extremely short, the green lamp may not flicker.)

This button is for switching the flash to the ordinary-shooting or daylight-sync flash mode. As you set the main switch at [ I ] to turn it on, the camera is set in the ordinary-shooting mode [ A ] in which the flash automatically fires when the subject is dark. Usually, take a picture in this flash mode. Refer to pages 14 – 16 on flash photography.

## OPERATING 38 ~ 60mm ZOOM LENS

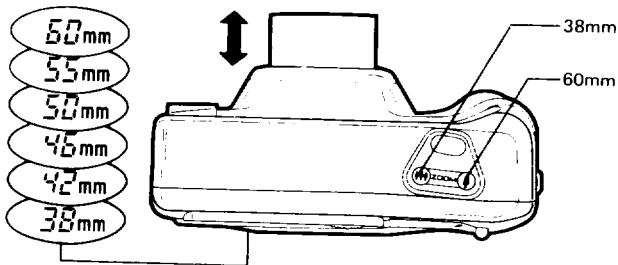

60mm



As you turn the main switch on by setting it at [ I ], and press the zoom button's [ ♣ ], the lens is set for 60mm tele photography. As you also press the zoom button's [ ♣♣ ], the lens is set for 38mm wide-angle photography. Release your finger off the zoom button when the composition you desire is obtained, and release the shutter.

- As you press the zoom button, the focal length of the lens is indicated in the LCD panel. (Also with a slight pressure on the shutter button.)
- When the main switch is set at [ I ], the lens is set at the 38mm focal length.



38mm

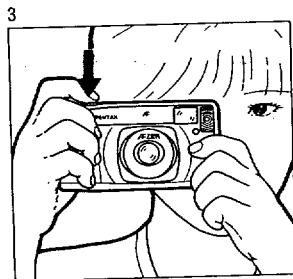
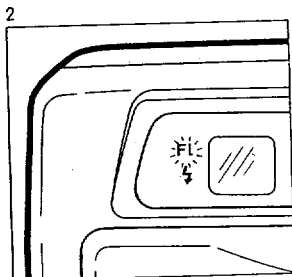

## TAKING ORDINARY PICTURES (Shooting range: one meter/3.3 ft. to ∞)



1. After composing by operating the zoom button, bring the autofocus frame [  ] on the main part of your subject.

- Be sure to turn the main switch on by setting it at [  ].
- Usually, the flash is set at the ordinary-shooting [  ] position. When the subject is dark, the flash is set to fire automatically. (The red lamp glows.)
- If you wish to change the subject you have focused to another, repress the shutter button.

2. As you press the shutter button half-way and the subject is focused on, the green lamp glows. If the subject is closer than one meter (3.3 ft.), the green lamp flickers and the shutter cannot be released. Make the camera-to-subject distance a little longer.
3. As you press the shutter button all the way down, the shutter will be released to take a picture. (After the shutter release, the film automatically advances to the next frame.)

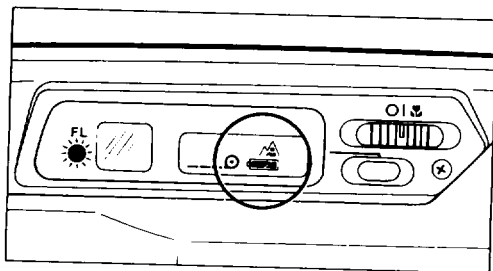

- When the green lamp flickers, the [  ] macro mark also flickers in the LCD panel and warns you that the subject is too close.

## FLASH PHOTOGRAPHY



### Auto flash (Automatic discharge)

When the flash is set in the ordinary-shooting mode [  ], it automatically fires when the subject is dark.

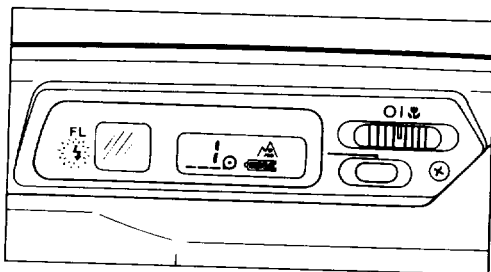

1. Make sure the symbol [  ] is indicated in the LCD panel. When the daylight sync flash symbol [  ] is indicated there, switch it to the [  ] symbol by pressing the mode switch button.
2. As you press the shutter button half-way in the dark or in a dimly-lit place, the red lamp next to the viewfinder eyepiece glows and the camera is set for flash photography.



3. When the red lamp glows, the flash is ready to fire, and when it flickers, the flash is being charged. Release the shutter after making sure the red lamp glows.

### Flash-effective ranges

(Nega-color film used)

Lens	ISO	50	100	400	1600
38mm [  ]		1 - 2.4m	1 - 3.4m	1 - 6.8m	*1 - 13.5m
60mm [  ]		1 - 1.6m	1 - 2.3m	1 - 4.6m	*1 - 9.2m
Macro [  ]		0.54 - 1m	0.54 - 1m	*0.54 - 1m	*0.7 - 1m

\*Because of high-speed film, overexposure may be made at close range.



#### Operational precautions

- To take a fine flash photo, shoot the subject in the flash-effective range.
- The flash recycle time is about three seconds with a fresh battery. If it takes more than five seconds for the flash to be ready, the battery is exhausted, and it should be replaced.
- Taking a portrait in color can cause "red eye," those red dots in the eyes, because the flash light enters the eyes and reflects back to the lens from the retina of the eye. This red-eye degree can be minimized by the following methods:
  - ① Make the room bright enough to be able to read books and make the pupils smaller.
  - ② Make the camera-to-subject distance shorter, and shoot with the lens on the wide-angle side.



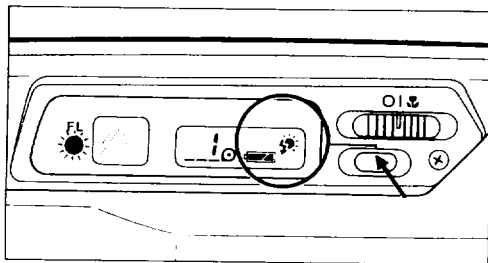

#### Daylight sync flash [ ]



As you press the mode switch button and let the symbol [  ] appear in the LCD panel, the flash fires even if the subject is bright, serving as daylight sync (fill-in) flash. When taking a portrait in the back-lighted situation or in the shade of trees, the subject often results in under-exposure because the meter mainly measures the bright background. The daylight sync flash helps you expose the subject and background properly.

Uncompensated



Compensated



- Press the shutter button half-way, make sure the red lamp glows, and release the shutter. The flickering red lamp indicates flash charging.
- When also using the flash as an auxiliary light in the daytime, shoot the subject within the flash-effective range.
- If you turn the main switch off and then on while the "daylight sync flash" symbol [  ] is on display, the flash will be switched to the ordinary-shooting mode [  ].

## UNLOADING FILM

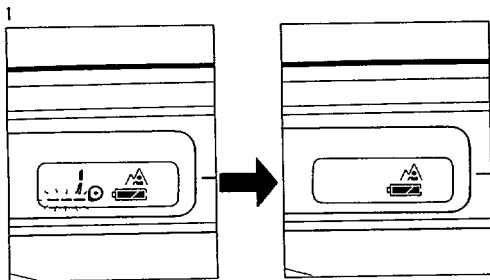

1. When you reach the end of the roll, the camera will automatically start rewinding the film. While the rewind is taking place, the exposure counter calculates backward. When the rewind is over, the motor stops, and as illustrated, the indications disappear.

- It takes about 25 seconds for the 24-exposure film to be rewound into the cartridge.
- Never open the back cover until the rewind is over.

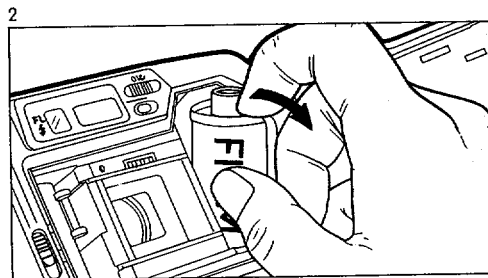

2. Open the back cover and remove the cartridge from the chamber by pulling its top with your fingertip as shown.

- The entire roll of film including the leader end is always rewound into the cartridge to avoid light leakage.

## TAKING MACRO (CLOSE-UP) PICTURES (Range: 0.54 ~ one meter/1.8 ~ 3.3 ft.)

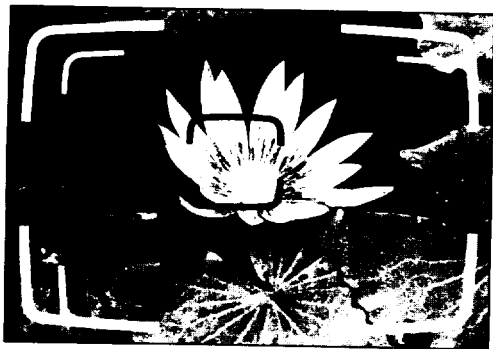

This shooting mode is to take close-ups of small flowers, insects, etc. When the lens is set for this mode, the area surrounding the picture area frame turns green. When shooting the subject about 0.6 meters (1.97 ft.) away, compose within the parallax-correction frame. When the subject is one meter (3.3 ft.) to infinity away, the lens is automatically switched to 60mm (telephoto) photography.

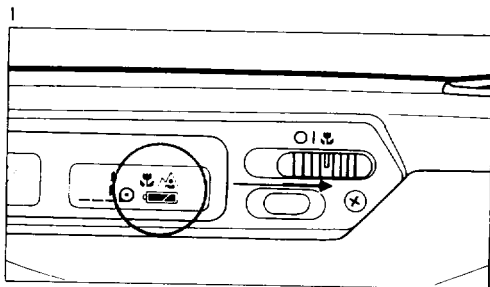

1. Set the main switch at the macro index [  ] as shown. To cancel the macro mode, just return the switch to the original position.

- The macro symbol [  ] appears in the LCD panel.
- Since the autofocus frame is off the center of the picture area in the macro shooting or close-range photography, use the focus-lock technique described elsewhere.

2

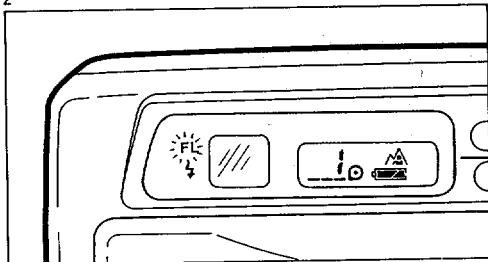

2. The macro shooting range is from 0.54 meters (1.8 ft.) to one meter (3.3 ft.). Make sure the green lamp glows by pressing the shutter button half-way, and release the shutter.

- When the camera-to-subject distance is not proper, the green lamp flickers as a warning, but note that it just glows when the distance is extremely short.

\*

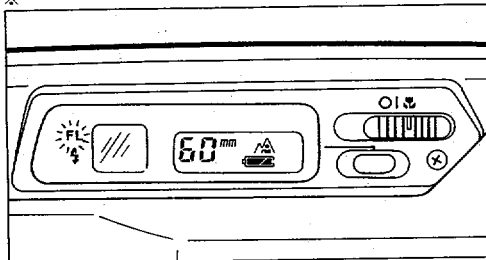

When shooting the subject one meter (3.3 ft) ~ ∞ away

Even when the camera is set in the macro mode, you can still shoot a distant subject (one meter/ 3.3 ft. ~ infinity away) with the zoom lens set at the 60mm telephoto position. Take a picture after making sure the green lamp glows by pressing the shutter button half-way.

- When you wish to change the subject you have focused for another, repress the shutter button.
- When shooting the subject one meter ~ infinity away, the macro symbol [  ] disappears, as you press the shutter button half-way.

## FOCUS-LOCK SHOOTING (FL)



If you shoot without placing the autofocus frame [  ] on the main part of the picture as shown above, only the background will be in focus. When the main subject of your picture is off the autofocus frame in the center of the viewfinder, use the focus-lock technique.



1. When taking a picture of two persons, for example, first bring the autofocus frame [  ] on one of the two.
2. As you press the shutter button half-way, the green lamp on the left-hand side of the viewfinder eyepiece glows, and focus and exposure are temporarily locked.

3



3. While pressing the shutter button half-way, reaim the camera or recompose the picture, and release the shutter.

- You can cancel the focus lock by just releasing your finger off the shutter button.

#### Hard-to-autofocus subjects

The autofocus system of this camera is highly precise, but like many other autofocus cameras, the system is not almighty and may not properly focus on certain subjects. In such a case, use the focus-lock technique on a subject near and equidistant from the actual one. The subjects which are hard to autofocus are:

1. Black objects like hair, etc. which are hard to reflect light (infrared).
2. Wire netting, latticework, iron exercise-bar, etc.
3. Flickering light sources such as neon signs, fluorescent lamps, TV images, sunlight coming through the trees, etc., or any subject illuminated by these light sources.
4. Glass, mirrors, car bodies, etc. which are glossy and reflective.
5. Fast-moving objects like trains.
6. Water jets, surface of water, smoke, flame, fireworks, etc. which are formless.

## FITTING STRAP; SOFT CASE

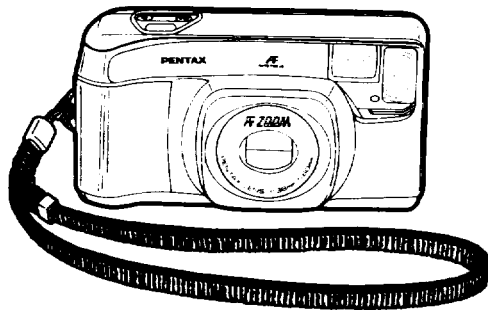

Fitted on the camera as shown, the strap becomes a neck or wrist strap.

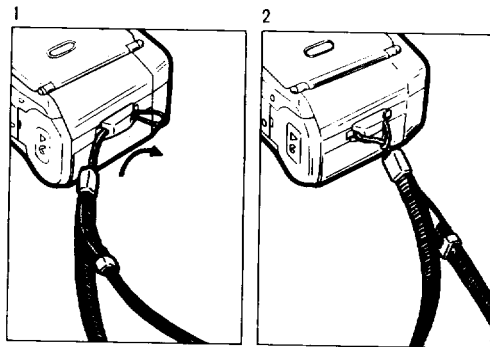

### How to fit

1. Pass the string of the strap through the strap lug.
2. Pass the other end of the strap through the ring of the string. Now it's a wrist strap.



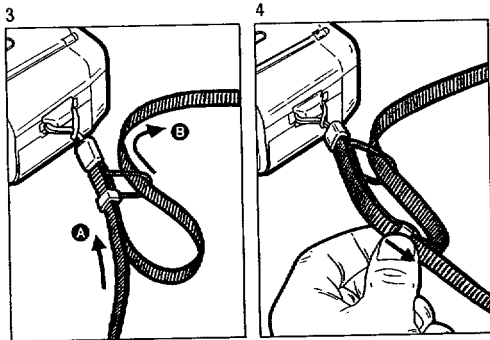

3. To convert it into a neck strap, **A** move the belt ring to the other end of the strap, and **B** pull the strap out from the small ring.
4. To reconvert it into a wrist strap, pull the belt ring out from the small ring, and move the belt ring to the other end of the strap.

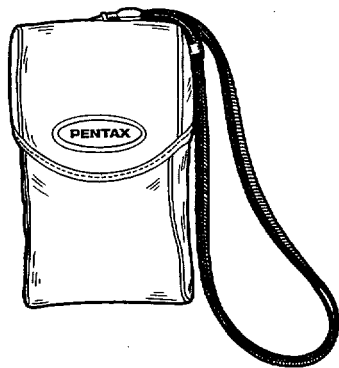

**Optional soft case (Available separately)**

When putting the camera into the soft case, be sure to turn the main switch off. Pass the strap through the hole on top of the case, as shown.

## BATTERY

### Precautions on batteries

- The misuse of battery causes hazards such as leakage, heating, explosions, etc. The battery should be inserted with the (+) or (-) side facing correctly.
- Never try to break up or recharge the battery, or throw the used-up one into fire as it may explode.
- The battery may lower its performance temporarily in low temperatures, though it differs from one type to another.
- Keep spare batteries on hand for convenience when shooting outdoors or traveling.
- When keeping the camera in a bag, make sure the main switch is off; otherwise, the battery power may be consumed by accidentally pushing the shutter button.

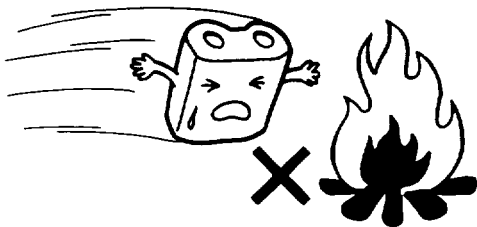

### LCD (Liquid-crystal display)

- When the LCD is exposed to a high temperature of about 60°C, it may blacken, but when the temperature falls, it will return to normal.
- The LCD may also slow down in response at lower temperatures, but it is one of the LCD's characteristics, not a defect.

### Battery life (with 24-exposure film)

Normal photography	Approx. 125 rolls
When normal photography and flash one made on 50-50 basis	Approx. 30 rolls

(CR-P2 battery used; based on our own test conditions)

# DATE MODEL

Equipped with an auto-calendar device, the Date model is designed to record the year, month and day up to the year 2019 on film. The data-imprinting device is powered by the same lithium battery that powers the camera. Therefore, the data set in the factory will be displayed in the LCD panel upon insertion of the battery into the camera. Set your local time and date in the panel by following the adjustment instructions given on the following pages.



## OPERATIONAL PRECAUTIONS

### When shooting

- The data (Year-Month-Day or Day-Hour-Minute) are recorded on film like the picture on the left. As you set the data you desire in the LCD panel, they are imprinted on the picture each time you release the shutter.
- If the corner of the picture where the data are imprinted is white or yellow, the data are difficult to see. When composing, try to avoid a bright subject at the corner.
- "Year-Month-Day" and "Day-Hour-Minute" cannot be imprinted at the same time.
- As you release the shutter, the bar mark [ - ] in the LCD panel flickers for a few seconds, indicating the data have been imprinted.
- This Date model works properly in the temperature range from 50° to -10°C.

## SETTING DATA

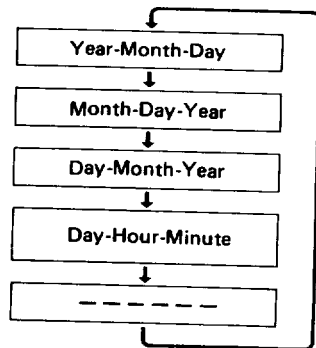
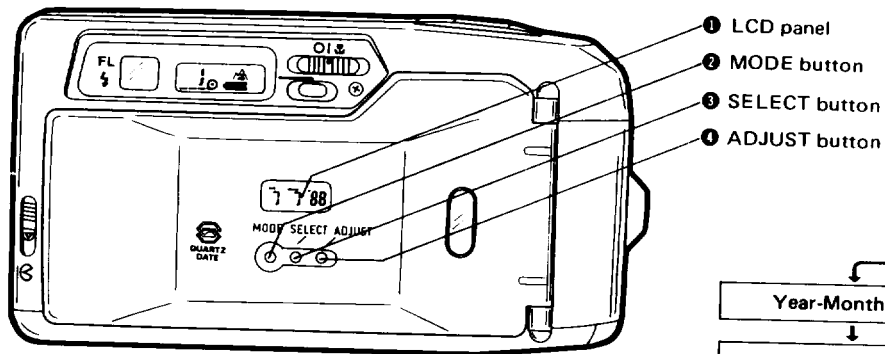

- To depress the SELECT or ADJUST button, you can use a match stick or the like.
- "M" in the LCD panel stands for "Month."

### Switching the mode

Each time you depress the MODE button ② with your fingernail, the mode in the LCD panel ① switches from "Year-Month-Day" to "Month-Day-Year" to "Day-Month-Year" to "Day-Hour-Minute" to "- - - - -". Stop depressing the button when the desired mode appears in the panel. "- - - - -" indicates no data are imprinted.

### Adjusting the data

● Depressing the SELECT button ③ at first, and the display will switch from any mode to "Hour:Minute" with the ":" mark flickering. Each time you depress the SELECT button ③, the flicker moves from ":" to "Minute" to "Hour" to "Day" to "Month" to "Year." Make the display you wish to adjust, flicker.

● Depress the ADJUST button ④ for changing the digits of the display you wish to adjust. The digit advances one by one each time you depress the ADJUST button ④. If you keep it depressed, the digit will, in a second or two, advance continuously.

### Adjusting the second

1. Depress the SELECT button ③, and ":" will flicker.
2. Depress the ADJUST button ④ according to a time-signal, and ":" will stop flickering for an instant, setting the second to zero.

### Adjusting "Hour:Minute" and "Year-Month-Day"

1. Make any digit or digits of the hour, minute, year, month, and day (which you wish to adjust) flicker by depressing the SELECT button ③
2. Set the digit or digits correctly by depressing the ADJUST button ④.  
Year = 87 – 19 (1987 – 2019)  
Month = 1 – 12  
Day = 1 – 31  
Hour = 0 – 23  
Minute = 00 – 59

## TAKING CARE OF YOUR CAMERA

Your Pentax camera is a sophisticated, precision instrument built to give long-lasting, reliable service. It will serve you well if you treat it right, with proper handling and reasonable care. The major causes of damage are:

1. Dropping or banging the camera against immovable objects, which can damage the camera in many ways.
2. Water damage, particularly if the camera is submerged in salt water. Your camera is not water-proof! It must be protected from salt breeze, salt spray at the beach, splashing of any kind, and shielded from the rain. If your camera does get soaked, wipe it dry immediately and rush it to a Pentax service center.



3. Dirt and sand can cause serious damage to the shutter and other moving parts of the camera. Your camera needs periodic cleaning to keep it operating properly. To remove dirt and dust, you need lens-cleaning fluid, lens-cleaning tissues, bulb-type ear syringe, camel's hair brush, etc. Never use a solvent such as thinner or alcohol.
4. Humidity and temperature extremes should be avoided. Keep your camera out of direct sunlight, car trunks, and glove compartments. Shooting outdoors in winter presents a problem since batteries won't function if they get too cold. In cold weather carry your camera under your coat or jacket to keep the batteries warm.

The temperatures at which this camera should function properly are approx.  $50^{\circ} \sim -10^{\circ} \text{C}$ . Sudden changes in temperature will often cause moisture to condense inside or outside your camera. This is a possible source of rust, which may be extremely harmful to the mechanism. Furthermore, if the camera is taken from a warm temperature to a sub-freezing one, further damage may result from the formation of icelets. Thus, sudden temperature changes should be avoided as much as possible. As a guide, a temperature change of  $10^{\circ} \text{C}$  should be allowed to take place gradually over a period of at least 30 minutes. If this is not possible, keeping the camera in its case or bag will help somewhat in minimizing the effects of a rapid temperature change.

5. Vibration experienced when you are traveling in a car, plane, or ship, can cause screws to loosen. To minimize this problem use foam-rubber padding about one inch thick to line the bottom of your camera bag.
6. Do not place the camera with the zoom lens down without turning the main switch off; otherwise, the zooming mechanism may be seriously damaged.

Hold the camera firmly. Take a relaxed stance, with your feet spread. Brace your elbows against your body. Support yourself by propping yourself or the camera against a wall, tree, table, etc. When using flash with the camera held vertically, keep the flash on the upper side. Do not hold the zoom lens. Do not place your fingers or hair on the autofocus window, flash, sensor window, etc. Always press the shutter button gently, holding your breath. Camera movement is responsible for unsharp pictures.

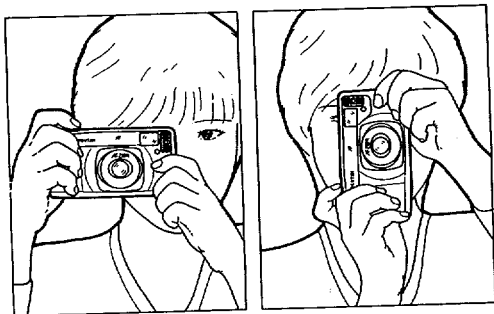

## SPECIFICATIONS

**Type:** Fully automatic leaf-shutter compact camera with zoom lens and auto flash. (Automatic focusing, automatic exposure control, automatic film-speed setting, automatic film loading, and automatic film winding/rewinding.)

**Film:** 35mm perforated cartridge film. 24mm x 36mm format.

**Lens:** Pentax power zoom 38mm ~ 60mm f/4.5 ~ f/6.7; 6 elements in 5 groups.

**Focusing system:** Pentax infrared active automatic focusing system with focus-lock device.

**Auto focusing ranges:** 1m (3.3 ft.) to infinity in ordinary shooting; 0.54m (1.8 ft.) to 1m (3.3 ft.) at MACRO.

**Exposure control:** Programmed automatic exposure control from EV 9.5 to EV 16.5 at WIDE, from EV 10.5 to EV 16.5 at TELE and from EV 14 to EV 16.5 at MACRO (at ISO 100).

**Shutter:** Electronically programmed between-the-lens shutter with shutter speeds from approx. 1/250 sec. to 1/30 sec. Electro-magnetic release.

**Viewfinder:** Zoom finder with albedo-bright frame. Automatic parallax compensation mechanism by prism at MACRO. Picture area: 82%. Magnification: approx. 0.4X at WIDE and 0.6X at TELE and MACRO. Information: picture frame mark, parallax compensation frame mark and auto-focus frame mark.

**External LCD indications:** Exposure frame number, lens focal length, film winding/rewinding, ordinary-shooting, macro shooting, daylight-sync flash and battery level.

**Film loading:** Automatic film loading with first-frame positioning.

**Film winding:** Automatic film winding.

**Film rewinding:** Automatic film rewind at end of roll. Automatic stop upon rewind completion.



**Film-speed setting:** Automatic film-speed setting with DX-coded film from ISO 50 to ISO 1600. (Fixed setting at ISO 100 with non-DX-coded film and DX-coded film of ISO 25, ISO 32 and ISO 40.)

**Flash:** Built-in automatic discharge flash. Recycling time: approx. 3 sec. with fresh lithium battery.

**Power source:** One 6V lithium battery (CR-P2 or DL-223A).

**Battery life:** Approx. 125 rolls of 24-exposure film without flash; approx. 30 rolls of 24-exposure film with flash used for 50% of shooting.

**Dimensions:** 135mm(W) x 73mm(H) x 57mm(D) (5.3" x 2.8" x 2.2")

**Weight:** 315g (11 oz.) without battery.

#### DATE model

**Data-imprinting function:** Selectable from five modes: day-month-year, month-day-year, year-month-day, day-hour-minute, and "-----" (no data). The power source: the 6V lithium battery that powers the camera body.

**Dimensions:** 135mm(W) x 73mm(H) x 59mm(D) (5.3" x 2.9" x 2.3")

**Weight:** 325g (11.5 oz.) without battery.

**Accessories for both models:** Strap (standard) and soft case (optional).

**SPECIFICATIONS ARE SUBJECT TO CHANGE WITHOUT ANY OBLIGATION  
ON THE PART OF THE MANUFACTURER.**

## WARRANTY POLICY

All Pentax cameras purchased through authorized bona fide photographic distribution channels are guaranteed against defects of material or workmanship for a period of twelve months from date of purchase. Service will be rendered and defective parts will be replaced without cost to you within that period, provided the equipment does not show evidence of impact, sand or liquid damage, mishandling, tampering, battery or chemical corrosion, operation contrary to operating instructions, or modification by an unauthorized repair shop. The manufacturer or its authorized representatives shall not be liable for any repair or alterations except those made with its written consent and shall not be liable for damages from delay or loss of use or from other indirect or consequential damages of any kind, whether caused by defective material or workmanship or otherwise; and it is expressly agreed that the liability of the manufacturer or its representatives under all guarantees or warranties, whether express or implied, is strictly limited to the replacement of parts as hereinbefore provided. No refunds will be made on repairs performed by non-authorized Pentax service facilities.

**Procedure During 12-month Warranty Period**  
Any Pentax which proves defective during the 12-month warranty period should be returned to the dealer from whom you purchased the equipment or to the manufacturer. If there is no representative of the manufacturer in your country, send the equipment to the manufacturer, with postage prepaid. In this case, it will take a considerable length of time before the equipment can be returned to you owing to the complicated customs procedures required in Japan in importing and re-exporting photographic equipment. If the equipment is covered by warranty, repairs will be made and parts replaced free of charge, and the equipment will be returned to you upon completion of servicing. If the equipment is not covered by warranty, regular charges of the manufacturer or of its representatives will apply. Shipping charges are to be borne by the owner. If your Pentax was purchased outside of the country where you wish to have serviced during the warranty period, regular handling and servicing fees may be charged by the manufacturer's representatives in that country. Notwithstanding this, your Pentax returned to the manufacturer will be serviced free of charge according to this procedure and warranty policy. In any case,

however, shipping charges and customs clearance fees are to be borne by the sender. To prove the date of your purchase when required, please keep the receipts or bills covering the purchase of your equipment for at least a year. Before sending your equipment for servicing, please make sure that you are sending it to the manufacturer's authorized representatives or their accredited repair shops, unless you are sending it directly to the manufacturer. Always obtain a quotation of the service charge, and only after you accept the quoted service charge, instruct the service station to proceed with the servicing.

**This warranty policy does not apply to Pentax products purchased in the U.S.A., U.K., or Canada. The local warranty policies available from Pentax distributors in those countries supersede this warranty policy.**



**Asahi Optical Co., Ltd.** C.P.O. 895, Tokyo 100-91, JAPAN  
**Pentax Europe n.v.** Weveldlaan 3-5, 1930 Zaventem, BELGIUM  
**Pentax Handelsgesellschaft mbH** Postfach 54 0169, 2000 Hamburg 54, WEST GERMANY  
**Pentax U.K. Limited** Pentax House, South Hill Avenue, South Harrow, Middlesex HA2 0LT, U.K.  
**Pentax France S.A.** Z.I. Argenteuil, 12, Rue Ambroise-Croizat, 95100 Argenteuil, FRANCE  
**Pentax (Schweiz) AG** Industriestrasse 2, 8305 Dietlikon ZH, SWITZERLAND  
**Pentax Scandinavia AB** Box 650, S-751 27 Uppsala, SWEDEN  
**Pentax Nederland** Spinveld 25, 4815 HR Breda, THE NETHERLANDS  
**Pentax Norge A.S.** Cecilie Thoresens VEI, Lambertseter, 1101 Oslo 11, NORWAY  
**Pentax Corporation** 35 Inverness Drive East, Englewood, Colorado 80112, U.S.A.  
**Pentax Canada Inc.** 3131 Universal Drive, Mississauga, Ontario L4X 2E5, CANADA  
**Asahi Optical Brasileira Ind. e Com. Ltda.** Rua Capitão Antonio Rosa 376, Sala 121 Ed. PBK, São Paulo, BRASIL

Specifications are subject to change without notice.  
56678 ENG

Copyright © Asahi Optical Co., Ltd. 1988  
2/91 Printed in U.S.A.

## Free Manuals Download Website

<http://myh66.com>

<http://usermanuals.us>

<http://www.somanuals.com>

<http://www.4manuals.cc>

<http://www.manual-lib.com>

<http://www.404manual.com>

<http://www.luxmanual.com>

<http://aubethermostatmanual.com>

Golf course search by state

<http://golfingnear.com>

Email search by domain

<http://emailbydomain.com>

Auto manuals search

<http://auto.somanuals.com>

TV manuals search

<http://tv.somanuals.com>