

# WORKSHOP MANUAL 50 cm3

*Motor FB-0-1-2-4*

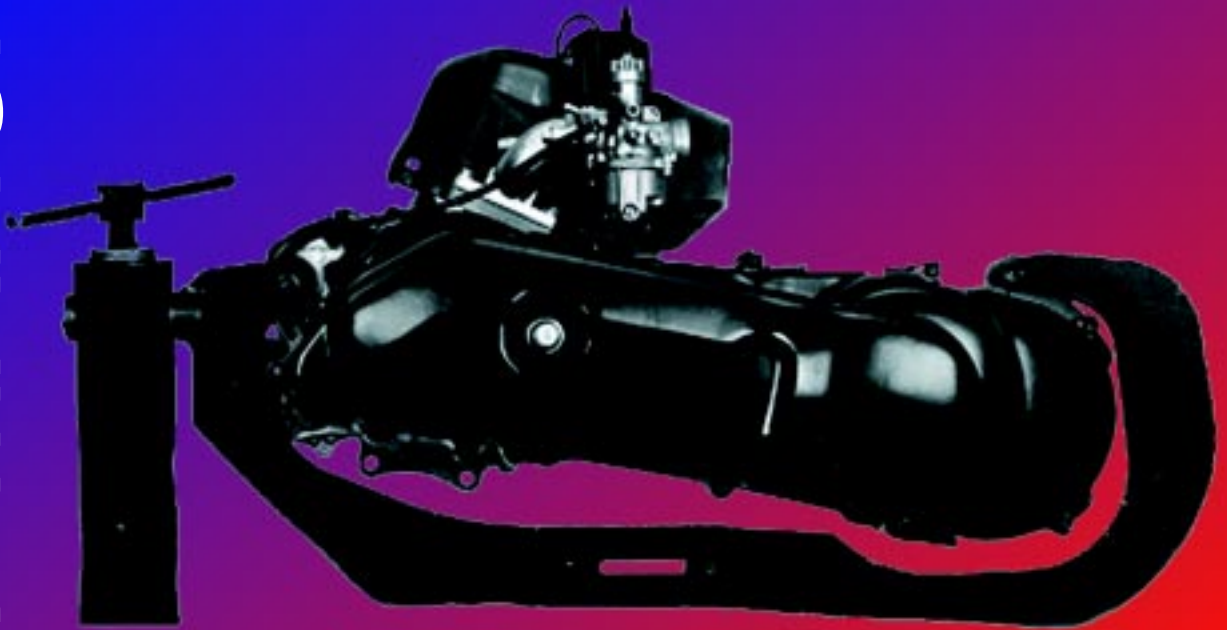

## ENGINE PART

Designation	Page
- Contents, .....	1
- Main characteristics, .....	2
- Maintenance plan, .....	3
- Putting into service, .....	4
- Special tools, .....	5
- Tightening torques .....	5

### Dismantling

Designation	Page
- Removing the engine from the vehicle, .....	6
- Placing the engine on the support, .....	6
- Removing the cooling system, .....	6
- Removing the flywheel, .....	6
- Removing the oil pump, .....	7
- Removing the starter motor, .....	7
- Removing the carburettor and choke, .....	7
- Removing the intake valve and connecting part, ..	7
- Removing the complete primary drive assy, .....	7
- Removing the kick starter system, .....	8
- Removing the relay unit, .....	8
- Removing the cylinder head, .....	8
- Removing the cylinder piston assy, .....	9
- Removing the RH housing, .....	9
- Removing the crankshaft from the LH housing, ..	9
- Replacing the crankshaft bearings and seals, .....	9
- Checking the crankshaft .....	9

### Refitting

Designation	Page
- Refitting the crankshaft, .....	10
- Closing the engine housings, .....	10
- Refitting the piston, .....	10
- Refitting the cylinder, .....	11
- Refitting the cylinder head, .....	11
- Refitting the relay unit, .....	11
- Refitting the kick starter system, .....	12
- Checking the driven pulley clutch, .....	12
- Checking the drive pulley variator, .....	12
- Refitting the primary drive, .....	12
- Refitting the intake valve and connecting part, ..	13
- Refitting the carburettor, .....	13
- Refitting the starter motor, .....	13
- Refitting the oil pump and setting, .....	14
- Refitting the flywheel, .....	14
- Refitting the cooling system .....	14

## CYCLE PART

Designation	Page
- Contents, .....	1
- Main characteristics, .....	2
- Maintenance plan, .....	3
- Putting into service, .....	4
- Tightening torques, .....	5
- Disc brake .....	14

## RECOMMENDATIONS

Designation	Page
- Spark plug .....	2
- Fuel .....	4
- Separate lubrication .....	4
- Relay unit .....	4

## ELECTRIC EQUIPMENT

Designation	Page
- Electronic ignition, .....	15
- Circuits supplied with alternative current, .....	15
. lighting, .....	15
. choke, .....	16
- Resistance check of stator, .....	16
- Circuits supplied with direct current, .....	17
. battery charge, .....	17
. fuel gauge, .....	18
. oil gauge, .....	18
. horn, .....	18
. indicators, .....	18
. starter motor circuits, .....	19
- Functional diagrams for electric circuits, ..	20 and 21
- Key to electric circuits .....	22

## Main spécifications

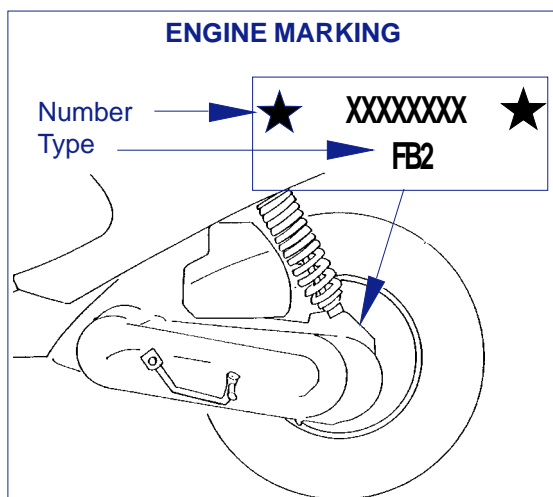

### FB2 ENGINE

#### Forced-air cooled 2 stroke engine :

- Bore and stroke : ..... 40 x 39.1
- Cylinder capacity : ..... 49.13cm<sup>3</sup>
- Compression ratio : ..... 6.6:1
- Maximum power (ISO) : ..... 3.1 kw

#### Distribution :

- Exhaust port : ..... 160c°
- Scavenging port : ..... 110°
- Air intake : ..... by reed valve induction
- Ignition : ..... CDI (capacitive-discharge ignition)
- Spark advance : ..... 13° before TDC
- Spark plug ..... Resistive 5K $\Omega$
- ..... NGK - BR7HS
- ..... EYQUEM R 850
- ..... BOSCH WR4AC
- spark plug gap : ..... 0.6mm

#### Carburettor : ..... GURTNER PA350

- Idling speed : ..... 1800 rpm  $\pm$  1 00 rpm
- Initial position of the pilot air adjusting screw :
- Anticlockwise rotation : ..... 1/2 to 13/4
- Needle with 3 levels : ..... clips at the top
- Main jet : ..... 74

#### Flywheel magneto :

- Number of poles : ..... 6
- Power : ..... 2500t = 55w
- ..... 5000t = 85w

#### Starter.motor : ..... MITSUBA

- ..... 2000w SM10 129
- ..... 1500w SM10254

#### Oil pump : ..... MIKUNI

flow 24cm<sup>3</sup>  $\pm$  1.7cm<sup>3</sup> / hour at 3800 rpm, wide open throttle. 1CM<sup>3</sup> = 0.031 cubic inch

## Transmission

- Clutch : ..... centrifugai, automatic type
- Primary réduction gear : ..... by a ribbed V-beit
- Life of belt : ..... 1 0 000 km
- Reducer equipped with 2 gearsets.

## Frame

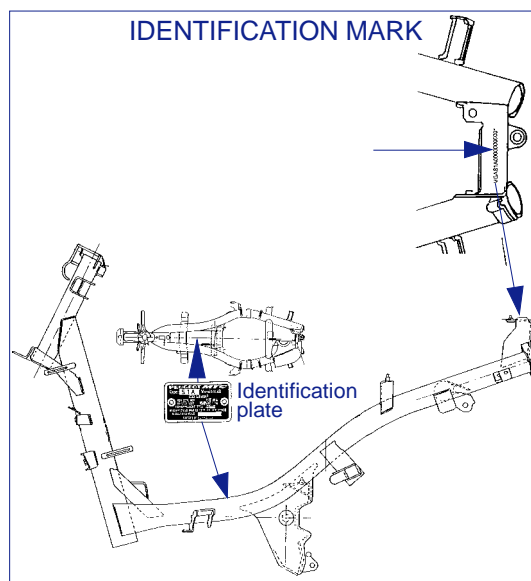

Identification : **VGAS1A** .....

- Front tyre : ..... 120/90 x 10
- Rear tyre : ..... 130/90 x 10

#### Pressure :

- Front : ..... 1,3 bar
- Rear : ..... 1,6 bar

## Capacities

- Fuel tank : ..... 6 litres
- Oil tank : ..... 1.3 litres
- Transmission case : ..... 0.12 litre
- Under-seat storage compartment : ..... 3 kg

## Dimensions

- Overall length : ..... 1760mm
- Overall width : ..... 670mm

#### Excluding rear view mirror :

Overall height : ..... 1110mm

#### Excluding rear view mirror :

Wheelbase : ..... 1250mm

## Weight

- Complete vehicle dry weight : ..... 82kg
- Vehicie weight with tanks full : ..... 88kg

## Markings 49cc

- Left hand casing (under the starter motor)
- Cylinder head (front right)
- Cylinder (exhaust flange left hand side)
- Intake pipe (on the front «49»)

# MAINTENANCE

## MAINTENANCE PLAN

Depending on how the scooter is used, it is recommended to apply either

- The normal maintenance plan or
- The reinforced maintenance plan.

### The normal maintenance plan includes:

- Visit at 500 km or 3 months **Plan A**
- Periodic maintenance every 5000 km **Plan B**
- Periodic maintenance every 10000 km **Plan C**

### The reinforced maintenance plan includes:

- Visit at 500 km **Plan A**
- Periodic maintenance every 2500 km **Plan B**
- Periodic maintenance every 5000 km **Plan C**

The reinforced maintenance is intended for vehicles used in so-called "severe" conditions: door to door sales, intensive urban use (courrier), short journeys engine cold, areas with dusty atmospheres, frequent use of vehicles at an ambient temperature above 30°C.

### CHECK :

- Idle speed adjustment
- Throttle
- Oil pump control
- Functioning of the electric equipment
- Front and rear brake control
- Fuel pipes
- Oil pipes
- Front brake fluid pipes
- State and pressure of tyres
- State, pressure and wear of tyres
- Brake fluid level
- Level of battery electrolyte
- Tightening of nuts and bolts

### REPLACE :

- Relay unit oil
- Spark plug
- Filter element of the intake silencer
- Front brake pads (if necessary)
- Rear brake linings (if necessary)
- Drive pulley rollers (if necessary)
- Transmission belt

### CHECK AND UNCLOG

- Piston
- Cylinder head
- Exhaust port

### CHECK AND LUBRICATE

- Driven pulley :  
movable driven face and needle bearing
- Drive pulley :  
movable drive face and rollers
- Kick : driven gear and link ring

### CLEAN AND ADJUST

- Carburettor

### VEHICLE TEST

- Road test

	<b>PLAN A</b> 500 km or 3 mois	<b>PLAN B</b> 5000 km or 2500 km*	<b>PLAN C</b> 10000 km or 5000 km*
Idle speed adjustment	X	X	X
Throttle	X	X	X
Oil pump control	X	X	X
Functioning of the electric equipment	X	X	X
Front and rear brake control	X	X	X
Fuel pipes	X	X	X
Oil pipes	X	X	X
Front brake fluid pipes	X	X	X
State and pressure of tyres	X		X
State, pressure and wear of tyres		X	X
Brake fluid level	X	X	X
Level of battery electrolyte	X	X	X
Tightening of nuts and bolts	X	X	X
Relay unit oil	X		X
Spark plug		X	X
Filter element of the intake silencer		X	X
Front brake pads (if necessary)			X
Rear brake linings (if necessary)		X	X
Drive pulley rollers (if necessary)		X	X
Transmission belt			X
Piston			X
Cylinder head			X
Exhaust port			X
Driven pulley : movable driven face and needle bearing			X
Drive pulley : movable drive face and rollers			X
Kick : driven gear and link ring			X
Carburettor			X
Road test	X	X	X

\* reinforced maintenance

## 1. Preparation of the battery

(dry charged)

- Remove the battery.
- Remove the six cell caps and the breather tube cap.
- Fill the battery with electrolyte up to the level marked UPPER LEVEL (35% sulphuric acid 1.28 g/CM<sup>3</sup>),  
Ref : ..... 1 litre : 752740  
..... 5 litres : 752741
- Leave the battery to settle for half an hour. Top up the level if necessary.
- Charge the battery for 1 to 2 hours with a current of 400mA (0.4A).
- Replace the battery and connect the breather tube.
- Connect up the red positive leads to the battery positive terminal, then the green negative lead to the battery earth terminal.
- From then on, the battery can be topped up if necessary, using distilled water only.

## 2. Fuel

- Capacity :** ..... 6 litres
- Conventional 4-star petrol.
  - Lead free petrol 98 octanes.

## 3. Separate lubrication:

- Capacity :** ..... 1.3 litres.
- Fill up the oil tank with semi-synthetic engine oil for 2-stroke engines with separate lubrication,
  - Type TC (API standard), type TSC3 (ASTM standard), -
  - Type FC (JASO standard) or a synthetic oil.
- PEUGEOT MOTOCYCLES recommends :**  
..... ESSO : 2T Special performance  
..... ESSO : 2T Synthetic

## 4. Putting fuel and oil circuits into opération:

- Put one litre of fuel mixture with 4% oil into the fuel tank.
- Fill up the oil tank.
- Start the engine: make sure that the oil circuit is completely primed. Remove the oil bleed screw from the pump to allow air in the circuit to escape. When a continuous stream of oil issues from this hole, replace the bleed screw with its fiber washer.  
For this : disconnect the oil intake hose to the carburettor and check that it drips, frequency depending on the engine's speed.
- Top up the fuel tank with pure 4 star petrol.

## 5. Checking the oil level in the transmission case:

- Unscrew and remove the oil filler hole screw A and make sure that the oil level is flush with the level of the filling hole. The vehicle must be positioned on its stand and on a level surface.  
Esso Oil SAE 80 W 90  
REF : ..... 753009  
capacity 0. 1 2 litre  
A = 1.2m.daN.

## 6. Checks before delivery to the customer:

- In particular, check the tightening of the Wheel nuts ... -  
front : ..... 6m daN  
- rear : ..... 10m daN
- Check the tightness of the nuts and bolts.
- Check brake adjustment and efficiency.
- Cold tyre pressure:  
**FRONT**  
- pressure : ..... 1.3 bar  
- size : ..... 120/90 x 10  
**REAR**  
- pressure : ..... 1.6 bar  
- size : ..... 130/90 x 10
- Make sure all lights and signals operate correctly (taillight, turnsignals, stop light, horn), and various warning lights.
- vehicle road test.

## TIGHTENING TORQUES

### Engine

Assembly screws for :

- Housings :	<b>1m.daN</b>
- Covers :	<b>1m.daN</b>
- Intake connecting part :	<b>1m.daN</b>
- Starter motor :	<b>1m.daN</b>
- Stator :	<b>1m.daN</b>
- Sensor :	<b>1m.daN</b>
- Fan :	<b>1m.daN</b>
- Carburettor :	<b>0.8m.daN</b>
- Oil pump :	<b>0.8m.daN</b>
- Cylinder head :	<b>1.2m.daN</b>
- Drive pulley :	<b>4m.daN</b>
- Driven pulley :	<b>4.5m.daN</b>
- Rotor :	<b>4m.daN</b>
- Oil plug :	<b>1.2m.daN</b>
- Spark plug :	<b>2m.daN</b>

### Frame

- Front wheel axis nut :	<b>6m.daN</b>
- Rear wheel nut :	<b>10m.daN</b>
- Engine joint on rod :	<b>6m.daN</b>
- Rod joint on chassis :	<b>2.2m.daN</b>
- Rear shock absorber upper fixation :	<b>1.6m.daN</b>
- Rear shock absorber lower fixation :	<b>1.6m.daN</b>
- Exhaust nuts on cylinder :	<b>1.6m.daN</b>
- Handlebar nut :	<b>4m.daN</b>
- Steering lock nut :	<b>7m.daN</b>

### Standard

- Screw and nut ø 5mm :	<b>0.45 to 0.6m.daN</b>
- Screw and nut ø 6mm :	<b>0.8 to 1.2m.daN</b>
- Screw and nut ø 8mm :	<b>1.8 to 2.5m.daN</b>
- Screw and nut ø 10mm :	<b>3 to 4m.daN</b>
- Screw and nut ø 12mm :	<b>5 to 6m.daN</b>

## SPECIAL TOOLS

- Service cradle mount .....	<b>64765</b>
- Adjustable adapter for engine service cradle .....	<b>752026</b>
- Flywheel holder .....	<b>68570</b>
- Snap ring pliers .....	<b>752000</b>
- Protective end, small model for flywheel magneto remover .....	<b>68007</b>
- Puiler tool .....	<b>64706</b>
- Crankshaft end protector .....	<b>69098</b>
- Shouldered centring tool .....	<b>64710</b>
- Screw on torque handle .....	<b>69104</b>
- Compressor tool, ail types of clutch .....	<b>752127</b>
- Tubular socket wrench 39 .....	<b>752361</b>
- Adjustable pin type face wrench .....	<b>752237</b>
- Set of half sheils 0 52 .....	<b>64709</b>
- Puiler tool .....	<b>750807</b>
- Support washer .....	<b>750808</b>
- Surface plate 250 x 160 x 50 .....	<b>750541</b>
- Comparator (adapts to pattern plate accessory .....	<b>750969</b>
- Torque wrench + extension + reducer .....	<b>69802</b>
- Flywheel puller supplied with 68007 protector .....	<b>750806</b>
- Blocking tool .....	<b>752370</b>
- Pliers for circlips .....	<b>69117</b>
- Spindle .....	<b>750069</b>
- Steering tools .....	<b>752948</b>

# REMOVAL

## Removal of the engine

### - Remove :

- All side casings

### - Disconnect :

- Fuel line from the carburettor,
- Fuel tap vacuum hose,
- Oil pump control cable
- Throttle control cable,
- Oil inlet piping at the pump (large hose)
- Radio interference suppressor cap
- Rear brake control cable

### Disconnect :

- The wiring harness on the frame's right tube: located at the outlet of the Flywheel magneto (under the foot board), choke, starter motor.

### Remove :

- The lower anchor bolt of the shock absorber and the front anchor pin of the engine.

## Fitting of engine on service cradle



- Place the engine onto the adapter 752026
- Place the assembly on the cradle mount 64765 clamped in a vice

## Removal of cooling system

- Remove the two parts of the fan covers (4 screws).

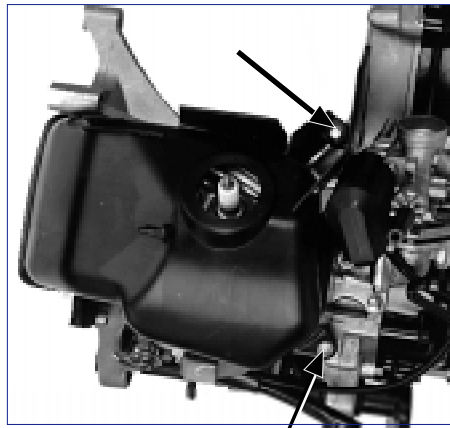
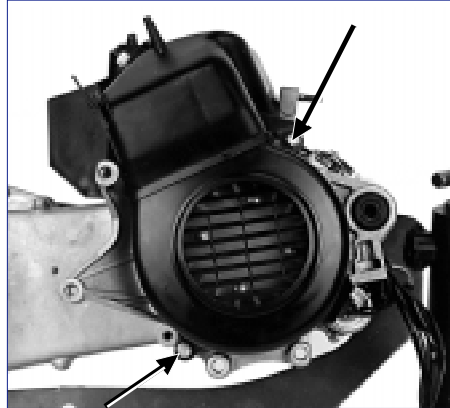

- Remove the 4 fastening screws of the fan and remove the fan.

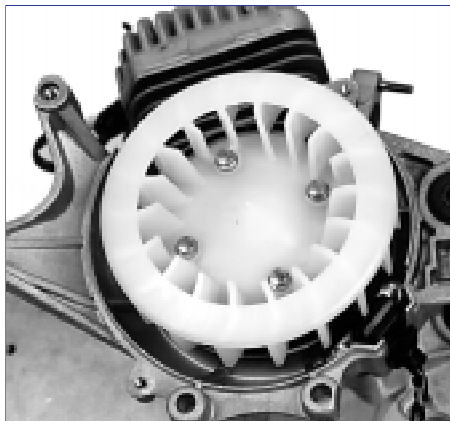

## Removal of the flywheel magneto

- Block the rotor using a notch type pin 752237.

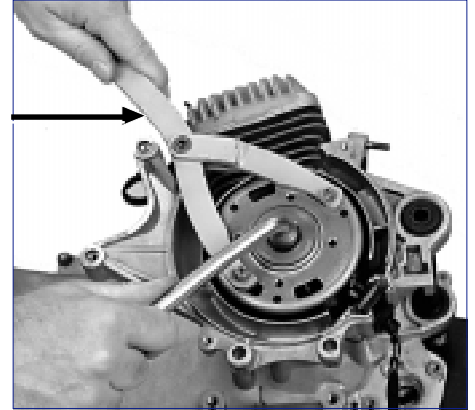

- Remove the nut (right-hand thread).
- Fit the crankshaft end protector 68007 onto the end of the crankshaft.

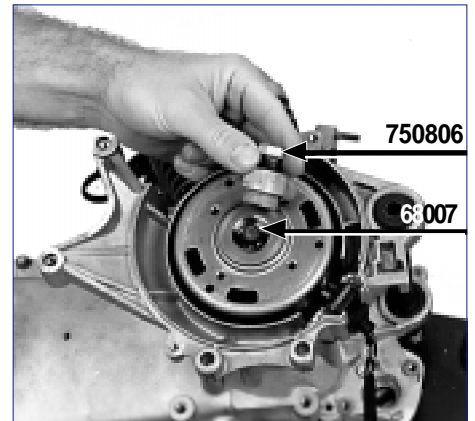

- Screw the flywheel puller tool 750806 onto the rotor and tighten the centre bolt until the rotor comes away.
- Remove the 2 fastening screws of the sensor, as well as the 2 fastening screws of the stator plate.

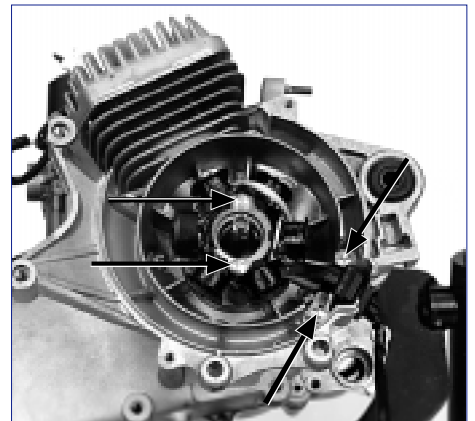

- Remove the coil assembly and the sensor.

## Removal of the oil pump

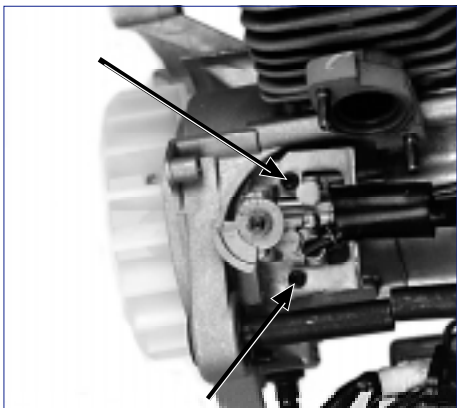

- Unclip the oil inlet pipe to the carburettor.
- Unscrew the 2 hex head socket screws.
- Remove the oil pump and the control flange.
- Remove the 2 square fastening nuts Q from their housings.
- Remove the flexible washer lodged between the pump and the shaft bearing of the oil pump.



- Adjustment: see page N° 14

## Removal of the starter motor



- Free the wire harness from the support bracket.
- Remove the 2 fastening screws and washers from the starter motor and pull out together with «O» ring seal.



## Removal of the carburettor / choke assembly

- Take off the 2 fastening screws from the carburettor and remove the carburettor / choke assembly, as well as the isothermal spacer.

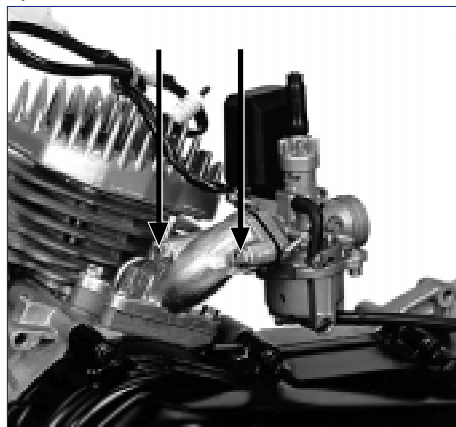

## Removal of the reed valve and intake pipe

- Unscrew and remove the 4 fastening screws.
- Remove the intake pipe, the gasket, the reed valve assembly and the second gasket.

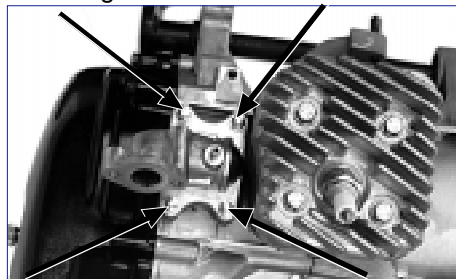

## Removal of the primary drive system

You do not have to remove of the kick starter arm when removing the crankcase cover.

- Loosen and remove the 11 fastening screws of the cover.

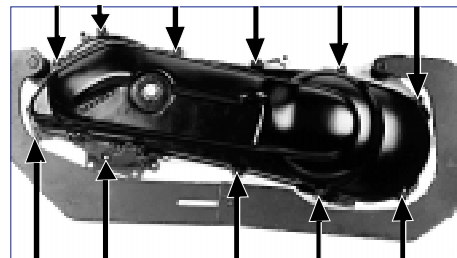

- Remove the cover with both locating dowls.

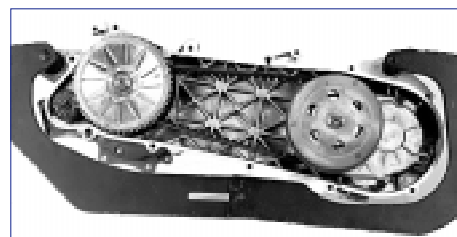

- Remove the starter drive assembly from the starter motor.



- Hold the starter ring gear with the tool 752370.

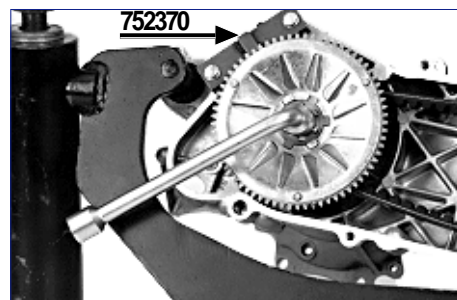



Make careful note of where this tool comes level with the starter ring gear plate of the starter motor in order to make sure, when refitting, that the pressure plate fits correctly into the grooves of the crankshaft.

- Loosen the fastening nut (right-hand thread) of the gear plate of the drive pulley.
- Remove the nut, washer and plate.
- Remove the belt.
- Remove the drive pulley assembly (variable speed drive) and the washer on the engine housing side (12,35 X 19,75 X 1).

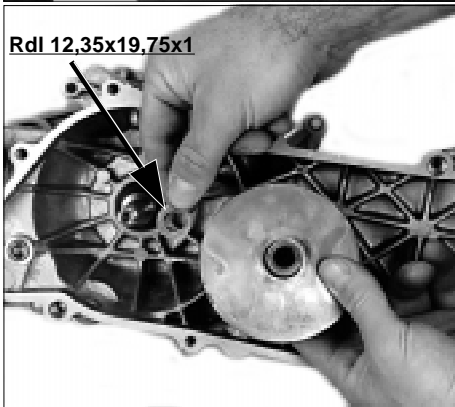
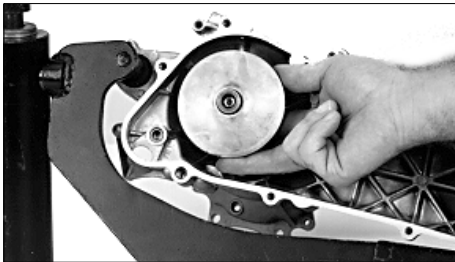

- Block the clutch drum with the fly-wheel pinch bolt no.68570 or the adjustable pin type face wrench 752237.

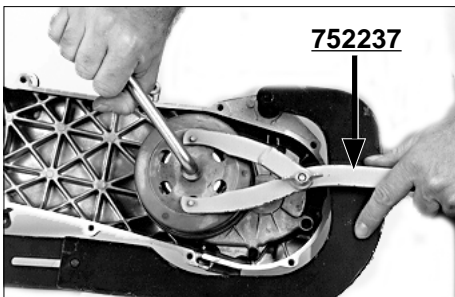

- Loosen the screw, remove the drum and the clutch driven pulley assembly.

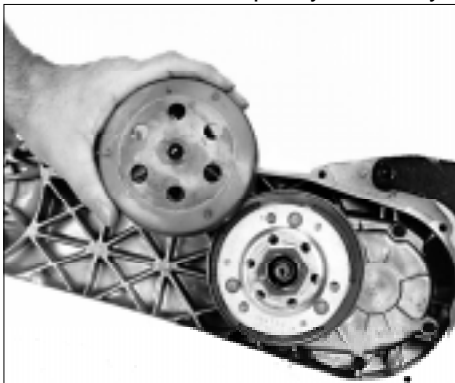

## Removal of the kick starter system

- Actuate the kick starter spindle with your thumb and remove the drive ratchet and its washer.



- Remove the kickstarter lever. Using snipe-nosed pliers (ref. 69117), take off the circlips, the washer, then remove the kick starter toothed section, the pull-back spring and the bushing.

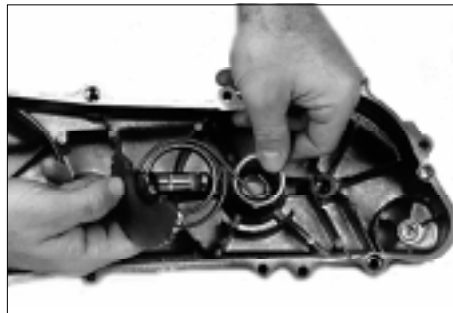

## Dismantling the transmission case

After draining the transmission case:

- Remove the 5 screws securing the cover.

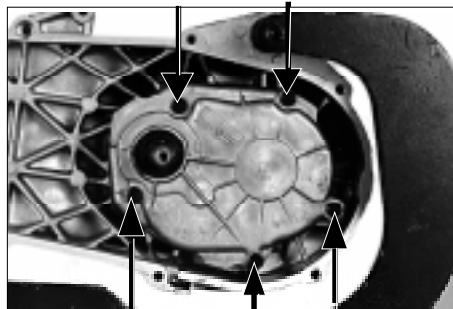

- Remove the cover with the drive shaft (or input shaft), the gasket and both locating dowls.

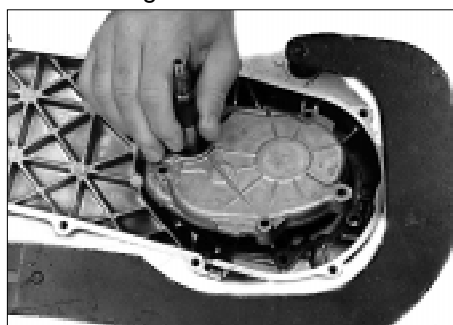

- Removal of the drive shaft (or input shaft) from the transmission cover is done using a mallet.
- Remove the thrust washer from the counter shaft (14.3x26x0.5).

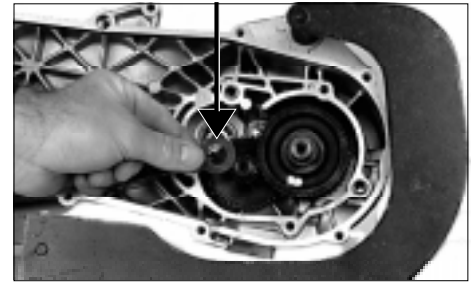

- Drain the transmission case completely before removing the final shaft (or output shaft) in order to avoid contaminating brake linings.
- Pull out the final shaft (output shaft).

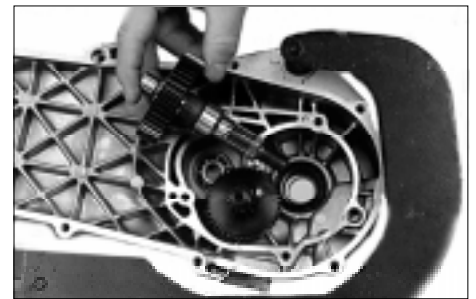

- Pull out the countershaft as well as its friction washers (1 4.3 x 26 x 0.5) and flexible washer (1 4 x 22 x 1.5).

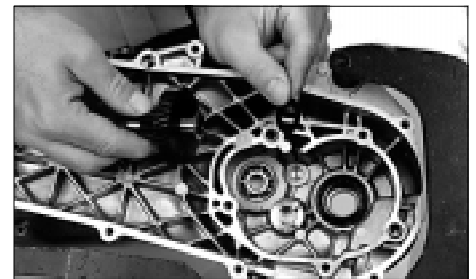

## Removing the cylinder head

- Unscrew in a crosswise order the 4 screws securing the cylinder head and cylinder block assembly.
- Remove the cylinder head and gasket.

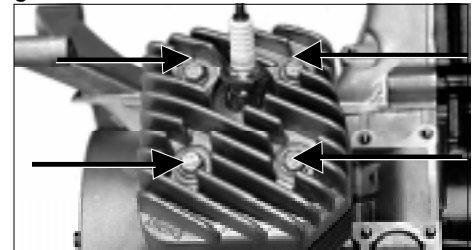

## Removing the cylinder and piston

- Remove the cylinder and cylinder-to-crankcase gasket.
- Pack the crankcase mouth with clean cloth or paper.

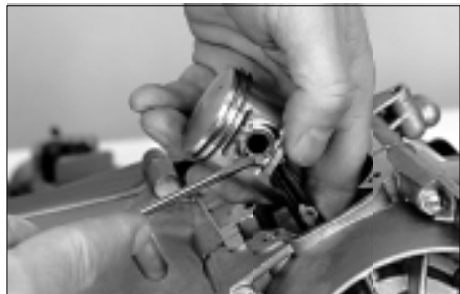

- Lean the engine to the left and take out the wrist pin's RH snap ring.
- Push the wrist pin from the left to the right; this operation does not require use of a strap.
- Take out the needle bearing race.

## Opening the crankcase

- Remove the 6 screws securing the RH crankcase half.

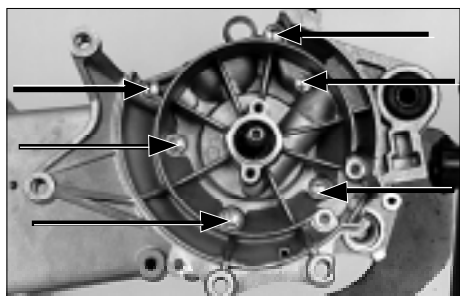

- Fit the crankshaft end protector 68007 onto the end of the crankshaft.
- Position the puller tool 750807 onto the crankcase half.

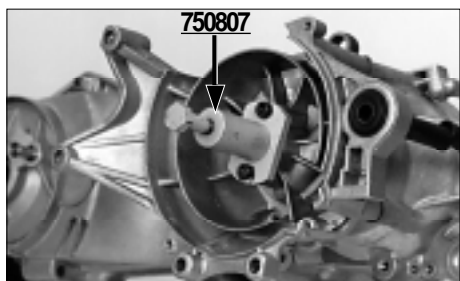

- Turn the inner thrust bolt of tool 750807 until the crankcase halves split. Hold the connecting rod so that it does not knock against the crankcase halves.
- Remove the RH half casing.



- Remove the gasket and both locating dowls. Remove the drive shaft of the oil pump and its locating bush.

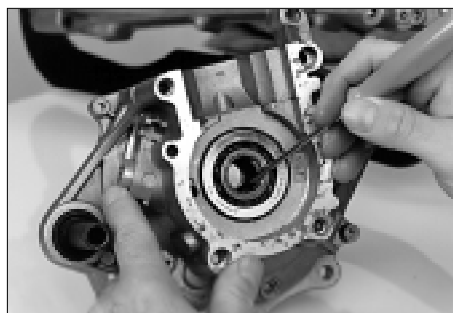

## Removing the crankshaft assembly

- Fit the crankshaft end protector 69098 onto the end of the crankshaft.

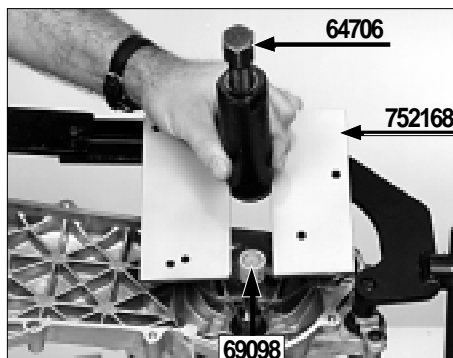

- Fit puller tool 647706 with the plate 752168 onto the crankcase.

- Secure the plate to the crankcase by tightening the 4 screws.
- Withdraw the crankshaft by turning the inner thrust bolt of tool 64706.



## Changing the bearings and seals

- Heat the crankcase halves evenly to 90° so that they expand. The bearings will drop out, drive out the seals.
- Fit the new bearings while the crankcase halves are still warm.
- Fit the oil seals in place.
- The oil seal on the drive pulley side should fit flush with the crankcase, the lips being on the flywheel housing side. The seal on the flywheel side should be approximately 9mm in.

### Note:

If the crankshaft bearings remain on the crankshaft; use the puller tool 64706 with the half shells 64709 (diam = 52) to remove them. Do not forget to fit the crankshaft end protector 69098 onto the ends of the crankshaft.

## Checking the crankshaft assembly

- The maximum side play of the conrod big end should not exceed: 0.5mm.
- Check crankshaft alignment as shown in the drawing (surface plate 750541, comparator 750969). The values measured at the ends should not exceed 0.12mm.

## Refitting the engine

Assembly of the crankshaft into the left hand crankcase:

- Fit the crankshaft into the bearing.
- Screw the extended nut 750069 onto the end of the crankshaft.

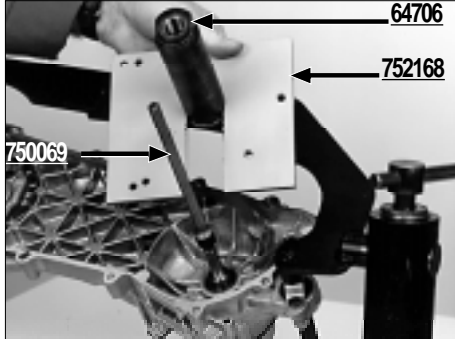

- Fit tool 64706 with the plate 752168 onto the extended nut and centre the assembly onto the crankcase using 4 screws.
- Position the centring tool 64710.

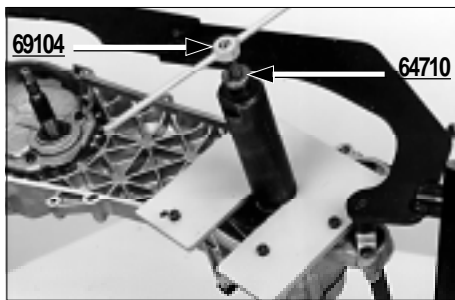

- Screw the torque handle 69104 onto the extended nut 750069 while keeping the crankshaft assembly steady. Continue turning the torque handle until the crankshaft comes into contact with the bearing.



### **Warning :** do not jam the conrod cabre in the crankcase.

In order to hold the crankshaft assembly easily, use the rotor positioned in its right hand side woodruff key.

Make sure the crankshaft assembly is correctly positioned in relation to the crankcase mouth (the middle of the conrod must correspond with the level of the crankcase mouth).

## Closing the crankcase halves

- Position both locating dowls in the LH crankcase:
- Put the crankcase gasket in place (no oil, no grease).

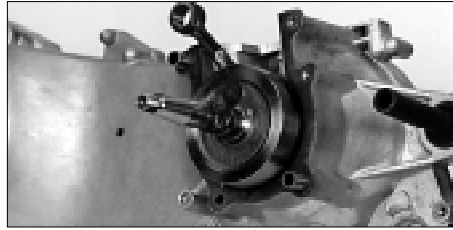

- Position the RH crankcase and fit it on being careful not to damage the oil seal where it meets the cotter key.
- Screw the extended nut 750069 onto the end of the crankshaft.
- Position the washer 750808 (50 x 29 x 3mm).
- Position the tool 64706.

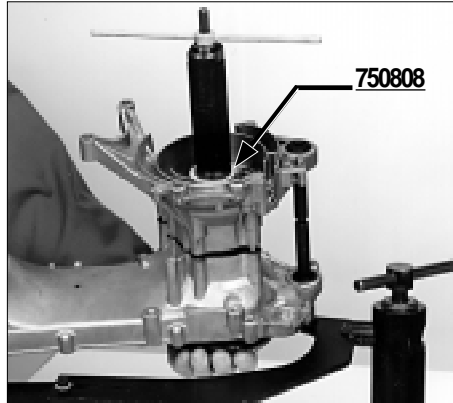

- Position the centring tool 64710.
- Turn the torque handle 69104 until the crankcases close completely.
- Hold the crankshaft assembly steady on the left hand side with the starter ring gear.
- Grease the oil pump shaft and position the shaft / seat assembly in the crankcase.
- Make sure that the crankshaft assembly can rotate normally and drives the oil pump shaft correctly.
- Position the 6 fastening screws (3 = L 45mm, 3 = L 70mm) and tighten them to 1 m.dan.

Make sure the crankcase gasket is level.



Lubricate the crankshaft assembly and bearings with 2-stroke engine oil.

## Refitting the piston

- Check the cylinder and piston parts are a matched pair.



- Fit the needle bearing race into the conrod small end after having oiled it (2-stroke engine oil).



- Position the piston with the arrow pointing towards the exhaust port.
- Push in the wrist pin.
- Fit the snap rings. It is essential that they are new.



The opening of the snap ring will be positioned at the top or at the bottom, but under no circumstances to the side.

## Refitting the cylinder

- The parting face should be cleaned.
- Lubricate the piston and the cylinder bore.
- Fit a new and dry cylinder base gasket onto the cylinder.
- Make sure that the piston ring end gaps are aligned with the positioning slots.
- Position the cylinder and push it down while squeezing the piston rings between your thumb and middle finger.
- Make sure the cylinder base gasket is correctly positioned on the crankcase using 2 threaded bolts.



## Refitting the cylinder head

- Check that the gasket seat surface of the cylinder head is not damaged.
- Position the 4 fastening screws onto the cylinder head with washers.

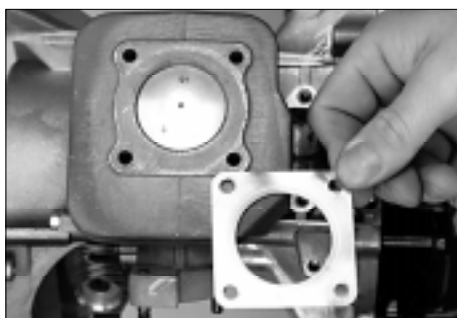

- Position the cylinder head gasket onto the cylinder head, the raised face upwards.
- Push the cylinder head / screw / gasket assembly onto the cylinder.
- Tighten the 4 screws progressively and in a crosswise order (L = 95mm) 1.2 m.dan.



-Fit the spark plug 2m.daN.

## Refitting the transmission case

- Replace the oil seals and bearings if necessary by the appropriate " heating and drift >, method.
- Check that the outlet channels are clear :

Removal of the case.

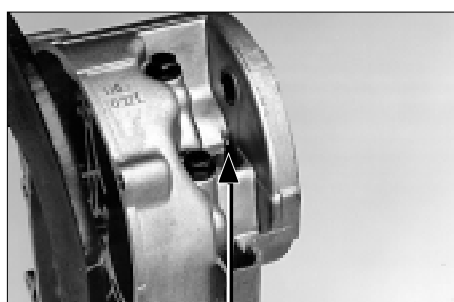
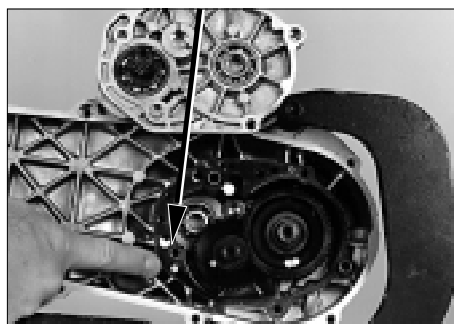

Outlet between the oil seal and the rear wheel bearing.

- Fit on the countershaft:
  - the flexible washer 14 x 22 x 1.5
  - the thrust washer 14.3 x 26 x 0.5.

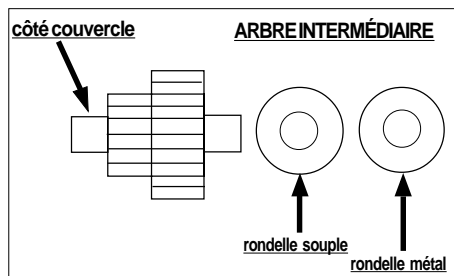
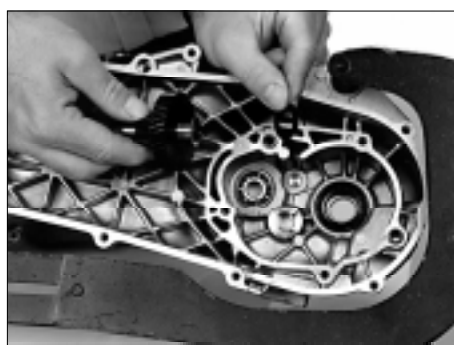

## Important

Smear the countershaft ends with graphite grease in order to ensure improved lubrication when putting the vehicle into service.

- Position the countershaft.
- Position the final shaft (or output shaft) while being careful not to damage the oil seal.

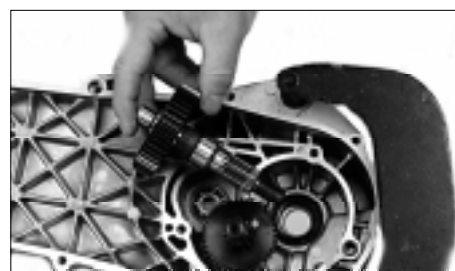

If this seal is damaged, oil will flow to the outside through the outlet slot located in the return spring housing of the brake key; Photo opposite.

- Fit a thrust washer 14.3 x 26 x 0.5 onto the countershaft;



- Position 2 locating dowls and the gasket.
- Position the primary shaft (or input shaft) into its bearing using a mallet if necessary.
- Position the cover and secure it using 5 screws (L = 40) 1 m.dan.



Make sure that the shafts can rotate.

## Note

- Fill the case with 0.12 litre of SAE 80W 90 oil.
- Peugeot Motorcycles recommends ESSO GEAR OIL GX..... ref. 753009
- Oil filler screw 1.2m.daN.

## Installing the kick starter (LH cover)

- Fit the spindle bushing and the nylon spacer (mark 1).

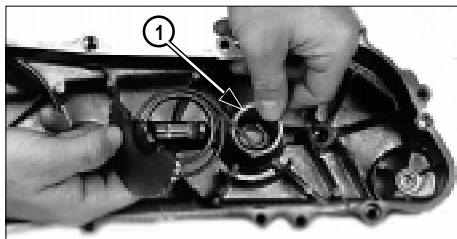

- Position the return spring, fit the longest hook onto the pin on the cover.  
 - Install the spindle into the bushing after lubrication.  
 - Fit the second hook of the spring onto the toothed section.  
 - Wind the spring slightly so as to position the kick starter spindle onto the central rib of the cover.  
 - Install the washer and circlips onto the axis of the toothed section.  
 - Position the drive ratchet: place the washer over the boss of the ratchet shaft housing load the kick starter by about 1/8 of a turn in order to position the ratchet (after lubricating the shaft), position the ratchet stop in its housing. (Mark 2).

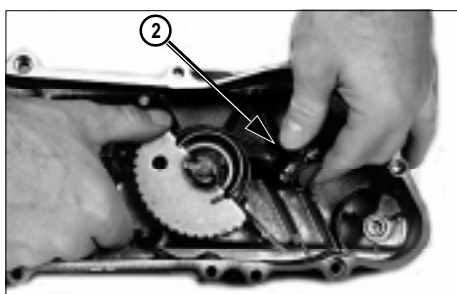

## PRIMARY TRANSMISSION

### A. Clutch and driven pulley assembly :

#### 1. Dismantling:



- Hold the assembly using tool 752127 in a vice and loosen the special nut with the wrench 752361 (39) or a 34 mm wrench depending on the clutch.  
 - Remove in the followin'g order :  
   . the clutch shoe assembly  
   . the spring  
   . the spring guiding sleeve  
   . take out the three guide pins of the variable speed drive,  
   . separate the movable driven face from the fixed driven face.



#### 2. Refitting

- Check the oil seals of the movable driven face.  
 - Assemble the fixed and movable driven faces.  
 - Refit the 3 guide pins and lubricate the ramp of the variable speed drive.  
 - Position the sleeve having checked that both «0» rings are in good condition.  
 - Position the spring and the clutch assembly.  
 - Using the tool 752127, compress the spring and check that the nut is tightened to 5m.daN.

### B. Drive pulley - variator assembly :

#### 1. Dismantling

- Remove the thrust spacer L = 38mm and the 3 bolts that secure the housing and the stop (no 7 wrench).



- Remove the housing using a screwdriver.  
 - Remove the stop, the ramp plate, the 3 plastic spacers and the 6 rollers, the «0» ring (81/1.5).

#### 2. Inspection



- After cleaning, check the rollers in particular. Their diameter should not show any flat spots.

#### 3. Refitting

- Reverse opérations to dismantling having lubricated the 6 rollers, the ramp, and the movable clutch plate bore with high temperature grease 752093.

#### NOTE :

On the first generation FB engines (Zenith, Buxy, Speedake), the rollers of the drive pulley were assembled without grease.

### C. Refit the primary transmission.

#### Fitting a variator

**Warning:** do not delete any piling up element or reduce the dimensions. This would lead to a tightening of the nut on the grooves of the crankshaft assembly and not on the fixes driven face and hence would destroy the crankshaft assembly.

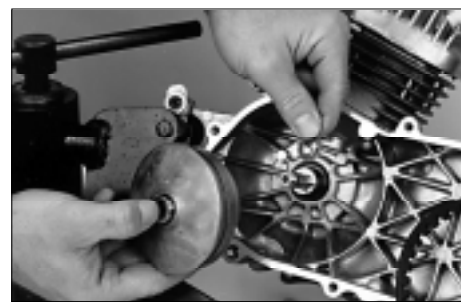

- Place the washer 12.35 x 19.75 X 1 on the crankshaft assembly.  
 - Position the variable speed drive while keeping the movable driven face, the 6 rollers and the variation ramp with the thrust spacer under pressure.  
 - Fit the drive belt.  
 - Position the start ring gear plate while checking that it is properly fitted on the grooves of the crankshaft assembly, position the nut and tighten by hand.  
 - Check that the ring is flush with the tool 752370.  
 - Tighten the nut to 4m.da.N.



## Fitting of the «clutch drive pulley» assembly and the belt

- Introduce the belt to the bottom of the groove of the driven pulley by pulling apart the drive faces using both hands.
- Position the belt on the drive pulley.
- Fit the «clutch / drive pulley» assembly onto the primary shaft of the transmission.
- Position the clutch casing and tighten the nut to 4.5m.daN while holding it in place with the adjustable pin type face wrench 752237 (or the flywheel holder).

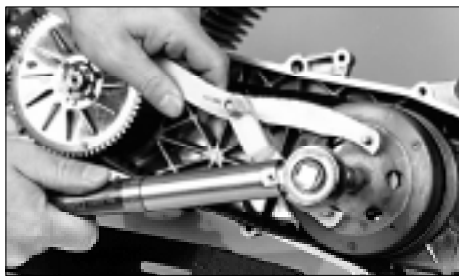

### NOTE

- The rollers must be checked every 5000km.
- The belt must be changed every 10000km.

## Fitting the transmission case



- Position the washer 8.5 x 16 x 0.8, the kick starter gear assembly. Grease its bearings.
- Position both dowel pins and the transmission case using 1 1 screws. Tighten to 1 m.daN.

## Fitting the reed valve and intake pipe

- **Check:** the condition of the petals and the seats.
- Install in the following order on the crankcase:

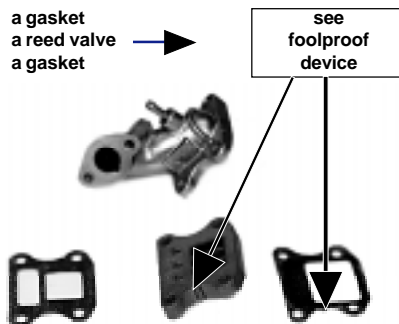

- Fasten all the parts using 4 screws (L = 28mm), and tighten to 1 m.daN.



## Fitting the carburettor

- Position both carburettor holding screws (L = 28 and 50mm) onto the intake pipe.
- Position the isothermic spacer with the seal on the intake pipe side. This spacer is aimed at avoiding heat from the engine being transferred to the carburettor. A foolproof system on the edge of the spacer guarantees that it is positioned correctly (arrow pointing towards the front).

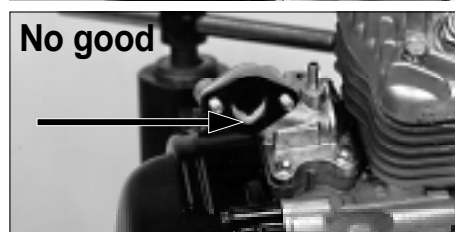
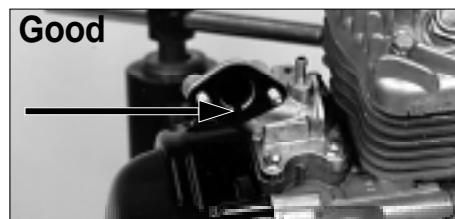

- Fit the carburettor and tighten to 0.8 m.daN
- Screw 1: air screw
- Initial adjustment: screw until it seats without forcing, then loosen by 11/2 to 13/4 of a turn.
- Screw 2: throttle stop screw (idle speed: 1800 rpm ± 100 rpm).
- Needle : clips at the top.

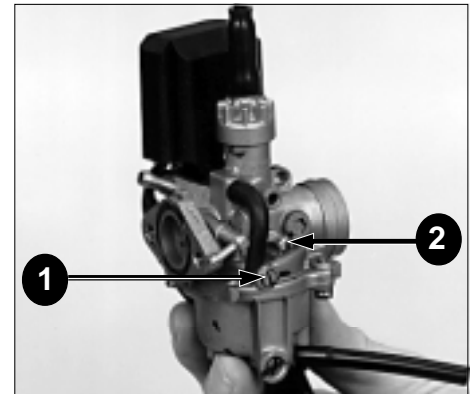

## Fitting the starter motor



- Install the starter motor with its «0» ring.
- The lower screw also ensures earthing of the battery to the engine (green wire).
- The upper screw also ensures fixation of the cable harness clamp.
- Tighten to 1 m.daN.



## Fitting of the oil pump

- Position both square nuts (Q) in their housings.
- Place the flexible washer on the seat.
- Position the pump fitted with its «0» ring, position the sheath stop fastening hook and fasten the cluster with two n».4 hex head socket screws.
- tighten to 0.8m.daN.

## Adjustment of the oil pump

- 1) Check the free play in the throttle grip (2 to 5mm) and adjust if necessary using the adjusting screw.
- 2) Open the throttle fully.
  - Check that the alignment mark on the pump control lever is opposite the mark on the pump body.

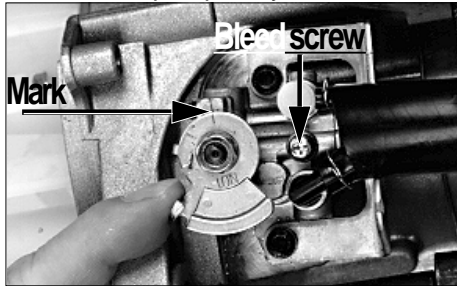

- Adjust if necessary by turning the pump cable adjusting nuts.

## Checking the lubrication circuit

- Supply the carburettor from a separate tank containing 2-stroke fuel mixture.

- Disconnect the oil input hose on the pump and check the oil flow. Check also :
  - . that there is oil in the tank,
  - . that the hose is not trapped,
  - . that the oil filter is not blocked,
  - . that the tank filler hole is not blocked (atmospheric pressure hole).
- Reconnect the hose onto the pump body.
- Open the pump bleeding screw until all the air bubbles have escaped and then close again.
- Turn the engine on. Disconnect the oil input hose on the carburettor. Check that the oil drips out. Dripping frequency depends on the engine's speed
- Reconnect the hose onto the carburettor. OIL PUMP FLOW: 24 cm<sup>3</sup> ± 1.7cm<sup>3</sup> hour at 3800 rpm. Wide open throttle.

## Fitting the flywheel

- Position the stator / sensor assembly on the crankcase.
- Fasten with 4 screws (2 screws L = 16, 2 screws L = 20). Tighten to 1 m.daN.



- Make sure that the woodruff key is indeed on the crankshaft.

- Position the rotor.
- Keep the rotor in place using the adjustable pin type face wrench 752237.
- Tighten the nut at 4m.daN.

## Fitting the cooling system

- Position and fasten the fan onto the rotor (4 screws L = 18). Tighten to 1 m.daN.
- Position and fasten the cylinder case and cooling cover (4 screws M = 25). Make sure that it is fastened correctly around the sensor.
- Tighten to a torque of 1 m.daN.

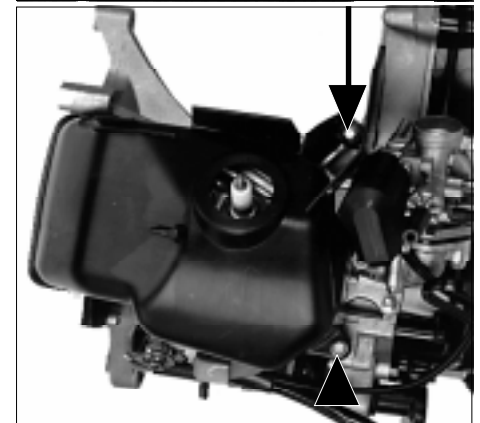
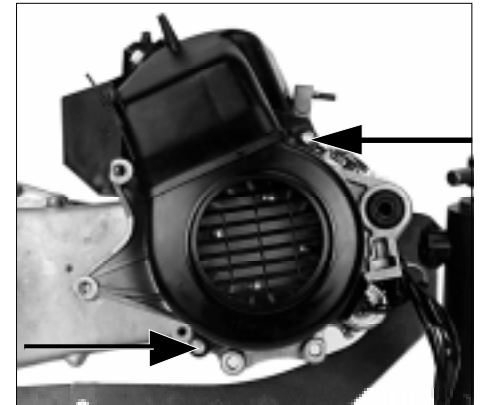

# CYCLE PART

## DISK BRAKE

### Filling the circuit :

At the receiver (brake calliper), remove the cap of the bleed screw. Connect a flexible hose to this screw, the other end put into an empty container (fuel hose for example). Loosen this bleed screw. Remove the cover and seal, with the tank positioned horizontally, from the emitter (master cylinder). Fill the tank with brake fluid. Activate the brake handle gently until the liquid comes through to the bleeding container. Tighten the bleed screw. Fill the emitter tank to the top.

Activate the brake lever several times with the cover refitted.

Loosen the bleed screw again. Air bubbles should escape through the flexible hose.

When there are no more air bubbles, tighten the bleed screw with the brake lever constantly on.

Repeat the operation until no bubbles appear in the liquid.

**Note:** At the end of the opération, top up the level.

- It is sometimes necessary to tap the elements of the brake system lightly in order for the air to escape.

- Certain callipers need to be dismantled in order to place the bleed screw in the high position.

### Warning :

- The brake fluid attracts humidity. In certain conditions humidity may impair braking efficiency. You must always use brake fluid from a recently opened container (tightness cap). The liquid recovered in the bleed container must not be reused. Do not open the container when there is a high degree of humidity in the atmosphere (rain, fog ....).

- Brake fluid is corrosive. Avoid spillage on painted parts.
- Do not spill fluid onto the pads or the disks.

- Use brake fluid which complies with the DOT 3 or DOT 4 standards. (Locked D55 for exam

## IGNITION

### Operating principle :

The ignition coil charges a condenser in the CDI unit. Passage of the rotor pad in front of the sensor authorises the discharging of the condenser in the primary winding of the high voltage coil via a thyristor, in order to generate through transformation in the secondary, a voltage in the region of 20 000 volts at the spark plug.

### Troubleshooting :

- Check the connections, especially the earth connection of the starter motor.
- Check by successively replacing with new components: the spark plug, radio interference suppressor, high voltage coil, CDI unit.
- Check the key switch.

Example of a breakdown: the engine only runs with the rear brake applied.

Cause: earth wire of the starter motor is damaged.

The CDI unit, ref. 709205 is used on all 50cc powered two-wheelers as well as on the SV 80cc.

### Warning :

A second CDI unit, ref. 705272 (marked CI 08) is reserved for SV 125 SC-SX models.

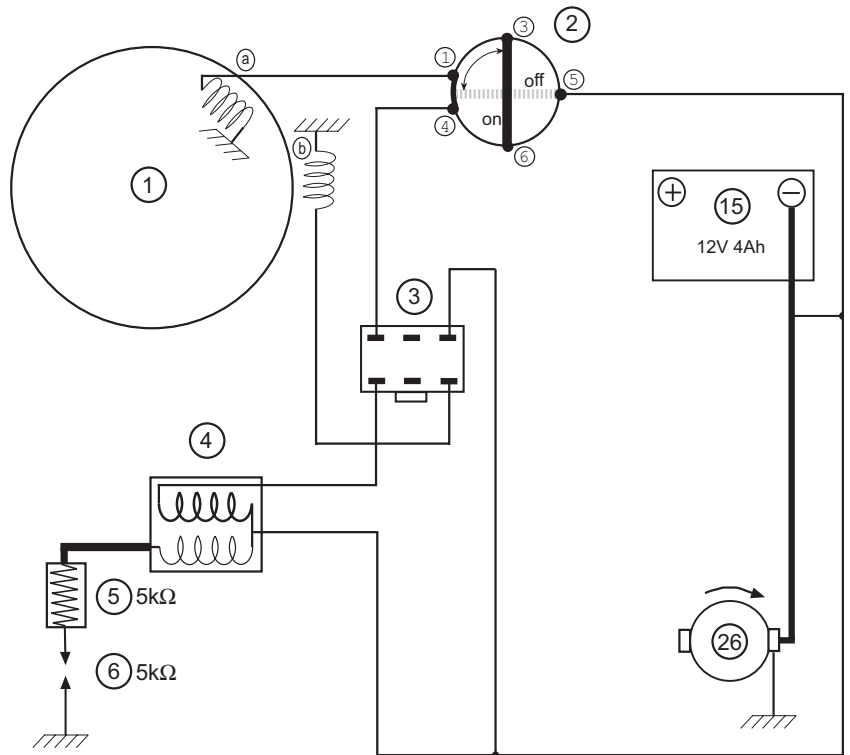

- 1 - Flywheel
- a - ignition
- b - sensor
- 2 - Ignition switch
- 3 - (CDI) ignition unit
- 4 - High voltage coil
- 5 - Interference suppressor 5 KW
- 6 - Spark plug resistance 5 KW
- 15 - Battery
- 26 - Starter motor

## ALTERNATING CURRENT POWERED CIRCUITS

### LIGHTING AND STARTER MOTOR

### Operating principle:

Three coils connected in series in the flywheel magneto generate an alternating current stabilised by the regulator to give a maximum voltage of  $12V \pm 0.5V$ .

## LIGHTING

When in the < lights off > position (Day\*), current is directed from the switch towards a resistance of  $5.9 \Omega$  30W where it is consumed (pink wire). When in the " lights on " position (night), current is supplied to the bulbs (brown wire); headlight, taillight, instrument panel light, headlight telltale.

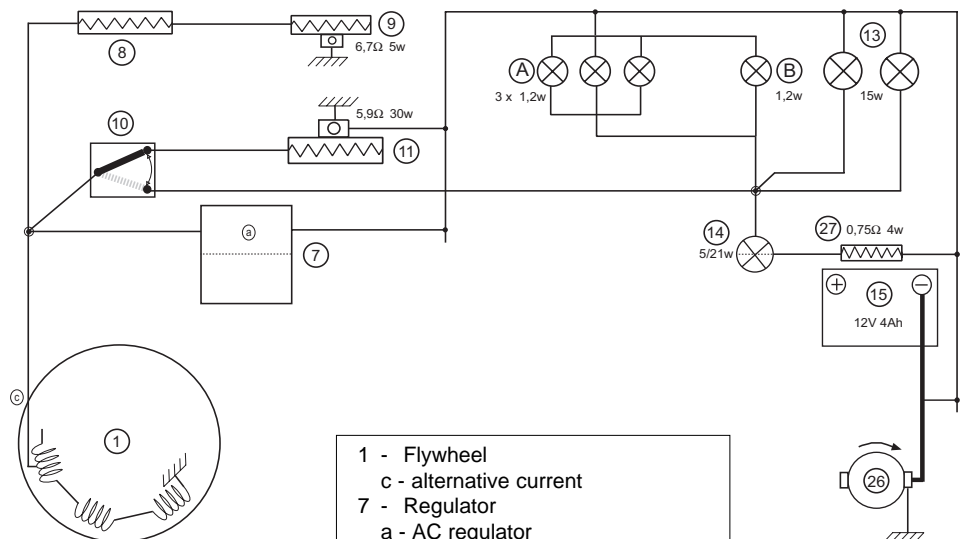

- 1 - Flywheel
- c - alternative current
- 7 - Regulator
- a - AC regulator
- 8 - Choke
- 9 - Resistance 6,7 W 5W
- 10 - Lighting control
- 11 - Resistance 5,9 W 30w
- 13 - Headlamp
- A - Instrument panel lighting
- B - Headlamp telltale
- 14 - Rear and stop light
- 15 - Battery
- 26 - Starter motor
- 27 - Current limiter



**Note :**

The rear bulb is composed of 2 filaments, one 5W filament supplied with alternating current for the taillight, one 21 W filament supplied with direct current for the stop light.

**1/ Solving lighting faults**

- Check the bulbs; power, voltage, compliance with European standards (EI).
- Check the connections (especially those of the regulator).
- Check the voltage using a multimeter (MX40) set to the AC voltmeter position. check at the terminale of a bulb (brown wire), that voltage does not exceed 12 volts ± 0.5V when accelerating the engine. If the voltage is over 13V, check the regulator connection (especially the green earth wire). If necessary, change the regulator (it is not possible to check the regulator when static).

**2/ Checking**

Check the continuit  capacities of the three coils of the flywheel. Engine stopped.  
Lighting and starter: yellow wire and earth wire = 0.4 ohm.

## CHOKE

**1. Operating principle**

Cold starting: the choke is automatically in operation: the carburettor's mixture enrichment circuit is open.  
As soon as the vehicle is switched on, the heat r sistance which is supplied by the flywheel magneto causes the continuons wax to expand in its capsule. The diaphragm pushes the master and intermediate pistons which cause the air duct to the throttle valve to close gradually and to progressively block fuel flow with the needle. When the engine is warm, with the ducts blocked, the enriching circuit is not operational.

**2. Checking**

- Average r sistance value of the choke alone - 5 ohms.  
**Note :**  
The r sistance value varies depending on r sistance temp rature: the colder the temp rature, the lower the r sistance value and vice versa.

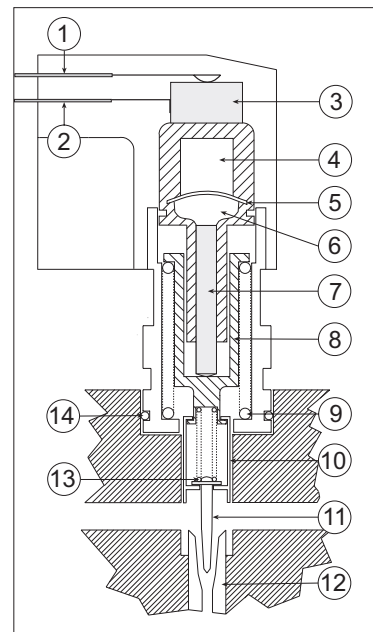

- 1 - Yellow wire
- 2 - Green-black wire
- 3 - Heating resistance (PTC)
- 4 - Wax
- 5 - Membrane
- 6 - Intermediate fluid
- 7 - Push piston
- 8 - Return piston
- 9 - Return spring
- 10 - Air throttle valve
- 11 - Needle
- 12 - Needle well
- 13 - Needle spring
- 14 - "O" ring seal

## Value flywheel control

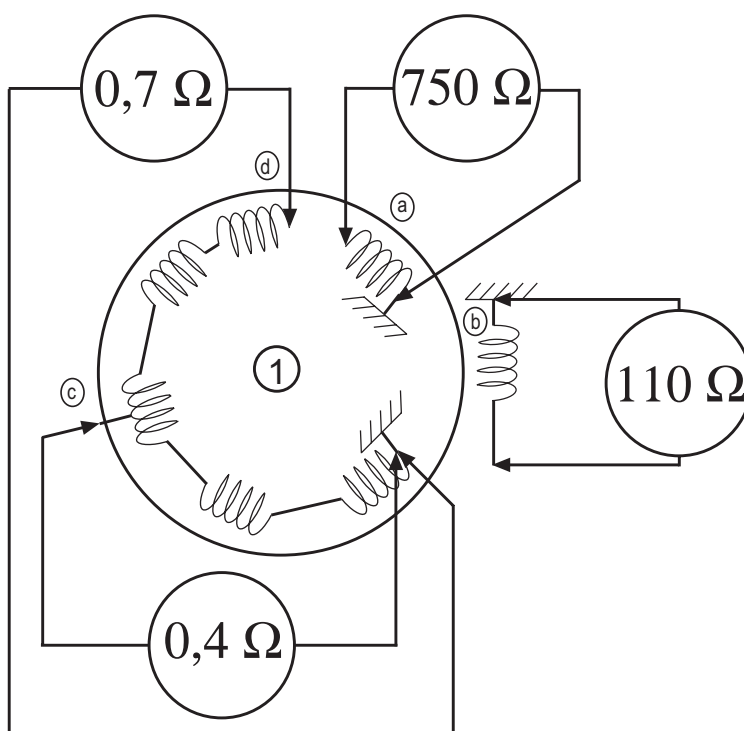

- 1 - Flywheel
- a - ignition
- b - sensor
- c - alternative current
- d - battery charge current

## DIRECT CURRENT POWERED CIRCUITS

### CHARGING BATTERY - STARTER MOTOR - FUEL GAUGE - OIL GAUGE - TURNSIGNAL LIGHTS - HORN

- 1 - Flywheel
- c : alternative current
- d : battery charge current
- 2 - Ignition switch
- 7 - Regulator, rectifier
- b : regulator, rectifier (DC)
- 14 - Rear and stop light
- 15 - Battery
- 16 - 5A Fuse
- 17 - Horn
- 18 - Horn button
- 19 - Indicator control
- 21 - Indicator bulbs
- D - Indicator telltale
- 22 - Fuel gauge
- E - Fuel gauge receiver
- 23 - Stop contact switch
- 24 - Starter motor relay
- 25 - Starter motor control
- 26 - Starter motor
- 27 - Current limiter
- 28 - Low oil level contact switch
- C - Low oil level telltale

#### Operating principle:

In the flywheel, the three coils used for the alternating current circuits are associated with two other coils to produce a regulated current increased to  $14.5V \pm 0.5V$  maximum by the current increasing regulator. (This time, its is the second stage of the regulator which is used),

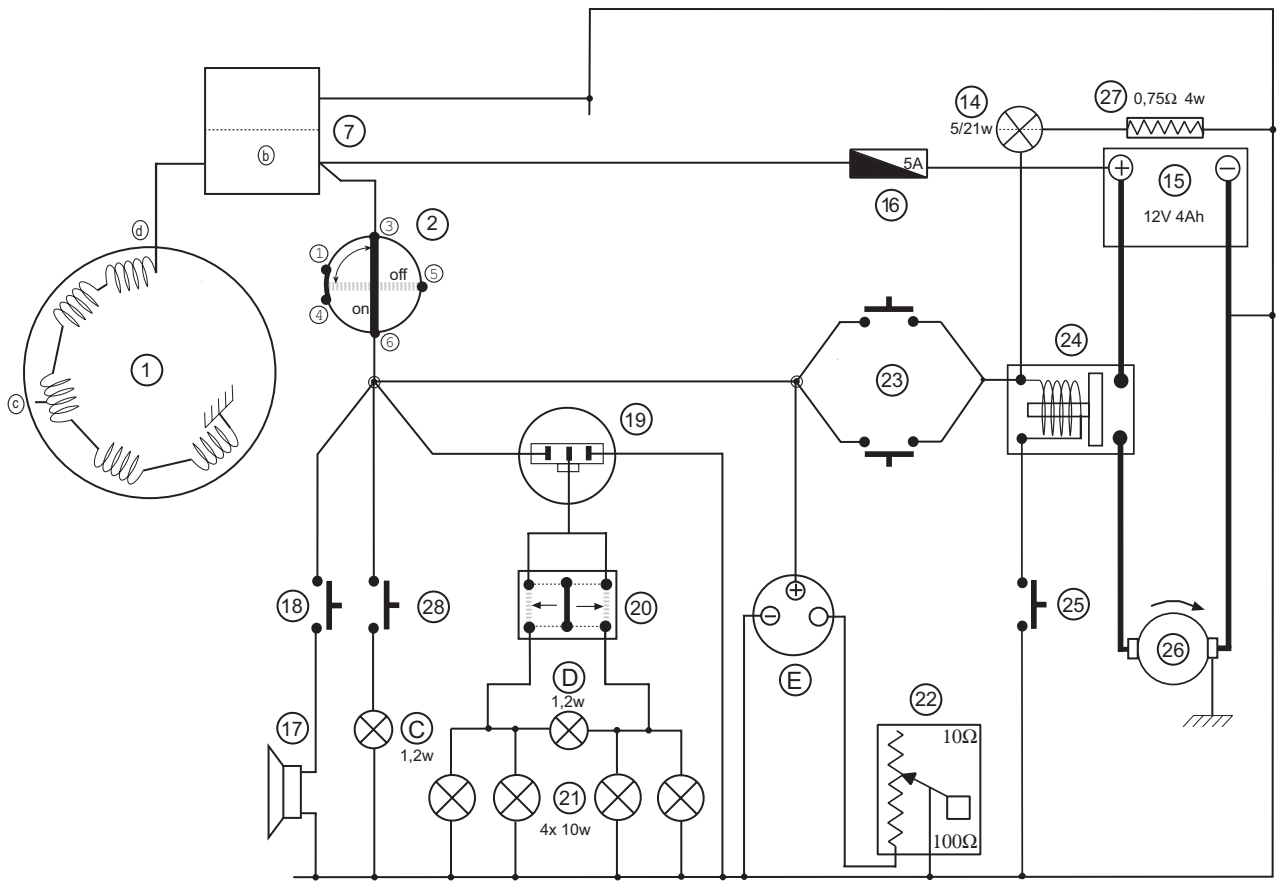

## BATTERY CHARGING

This circuit consists of the following elements connected in series: flywheel magneto - regulator - fuse - battery.

The voltage depends on the engine's speed.

While this voltage is lower than battery voltage, it is the battery which supplies the various circuits. As soon as this voltage is higher than battery voltage, it is the flywheel which supplies the various circuits and recharges the

battery.

Putting the battery into service: see maintenance page N° 3.

#### Checking the charge

Use a multimeter (MX40) set to the DC voltmeter position (=) connected to the terminals of the battery. Check that the voltage varies depending on the speed of rotation of the engine up to a maximum of  $14.5V \pm 0.5V$ .

If the voltage at the battery terminals exceeds 15V, the regulator is not connected to earth or is faulty. If there is no variation in voltage at the battery terminals, check the fuse,

connections, especially those of the flywheel or regulator harnesses (loose connections inversion of wires in the connector for example).

#### Checking a discharge

Engine off.

Disconnect the red wire from the battery.

Use a multimeter (MX40) set in the Ammeter (10A) position, connect the black wire (COM) to the + terminal of the battery and the red wire (10A) to the disconnected red wire of the battery.

## 1. Key switch to OFF

No display should appear on the multimeter. If a value is displayed (for example 0.5mA), either the regulator (connection wires) or the key switch is faulty.

## 2. Key switch to ON

A slight discharge can be explained by sending a volt supply to the fuel gauge and to the oil low level warning light (0.9mA to 100mA maximum).

A significant discharge indicates a more or less earthed circuit.

Disconnect the various circuits until the discharge disappears and locate either the defective unit or wire (starter, motor, stop light, fuel gauge, oil, indicator, horn, key switch or instrument panel circuits).

## Checking the capacities of the flywheel magneto.

Battery charge (current = )

White wire = 0.7 ohm and earth.

## FUEL GAUGE

### Operating principle

Resistance from the fuel meter to the tank varies depending on the level of fuel from 10 to 100 ohms. On the instrument panel, the needle will vary according to this resistance from min. to max. When the needle reaches the reserve supply level, this indicates a remaining riding range of about 25km.

### Checks :

ignition to ON

If the fuel meter is permanently at maximum level:

- Disconnect the gauge if the minimum level appears, check the gauge.
- If the maximum level is still shown, disconnect the 5-way connector on the instrument panel. Check, using a multimeter (MX40), set in the ohm position, that the yellow / white wire is not earthed. If this wire is earthed, check the harness. If this wire is not earthed, change the instrument panel.
- If the gauge indicator is permanently at minimum level:
  - Check that the tank gauge is connected properly
  - Check the capacities of this gauge (5 to 100 Ω)
  - Check the 5-way connector on the instrument panel: black wire to way no.1, yellow/white wire to way N° 4.
  - Check that the black wire receives a 12 volt continuous supply.
  - Check that the yellow/white wire is continuous up to the gauge. If not,

check way N°1 on the 9-way main connector.

## OIL GAUGE

### Operating principle

Supplied with a continuous current. The float acts like a switch; when it is in a low position, it closes the circuit which causes the warning light on the instrument panel to come on.

### Checking :

If the bulb on the instrument panel remains permanently on, check the float.

If the bulb remains permanently on, check the 4-way connector on the instrument panel (terminal 4, the blue / white wire must not receive a 12 volt supply while the float is in high position).

## HORN

### Operating principle

Supplied with a continuous current, a horn and a switch are fitted in series.

### Check :

- If the horn does not work, check the circuit (fuse, key switch, left-hand grip handle switch), in order to get 12 volts at the horn terminals.
- Check that the horn is planned for use with continuous current (presence of an adjustment screw, here hidden by a plug). Horn test

## INDICATORS

### Operating principle

A direct current supplies the blinker control unit located under the front cover. This current is sent to the left-hand grip handle to be distributed by the switch to the left-hand or right-hand bulbs of the turn signal lights. The telltale on the instrument panel is common to both sides. Its earth return line is via the bulbs on the side not used.

### Checks :

- If the central unit starts functioning erratically, either an indicator bulb is not working or the main connector (9-way) is not properly connected.
- If the central unit makes a crackling sound, either there is a short circuit between an orange or blue wire and earth or the battery is discharged.
- If the central unit does not work, before changing it, check:
  - Battery voltage (it must be over 10 volts).
  - the 4 bulbs of the indicators and the telltale bulb.
  - that the central unit is supplied with 12 volts (if not, check the fuse, the key switch, the connections, the black wire).

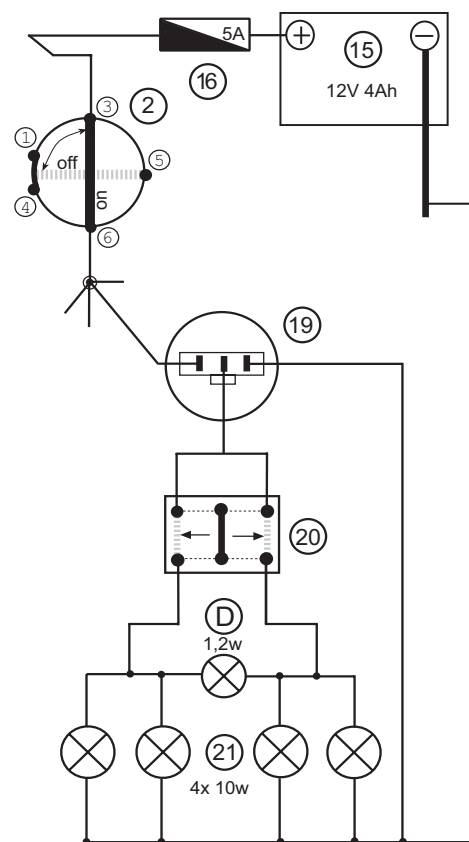

- 2 - Ignition switch
- 15 - Battery
- 16 - 5A Fuse
- 19 - Turn signal relay
- 20 - Indicator control
- 21 - Indicator bulbs
- D - Indicator telltale

## STARTER MOTOR CIRCUITS

### Operating principle :

The starter motor requires two circuits.

#### 1. Control circuit :

This consists of the following elements connected in series:

Battery, fuse, key switch, stop switches, starter motor relay, start switch (START).

With the ignition key in the ON position, one or both stop switches closed, the start switch closed, the current supplied by the battery runs through the coils of the relay and closes by magnetic force, the power circuit contact.

#### 2. Power circuit :

This consists of the battery and starter motor.

Activated by the relay, this circuit consists of big wires aimed at supporting high intensity. This circuit is not protected by the 10A fuse.

### Troubleshooting :

Checks in the event of non starting.

Battery in good condition.

If the relay «clicks», check the battery connections, the starter motor connector, earthing of the starter motor, the starter motor itself.

If the relay does not «click», look at the taillight:

. if the taillight comes on, check the relay

. if the taillight does not come on, check: the battery, fuse, key switch, stop lights, connectons.

Relay is good and working order

Relay at of order

### Checking the starter motor :

Connect the starter motor directly to the terminale of a 12 volt battery.

### Checking the relay :

Connect a battery to the terminale of the control circuit (small yellow / green and purple wires). If the relay is working correctly, it will «click» and will make contact with the two other terminals.

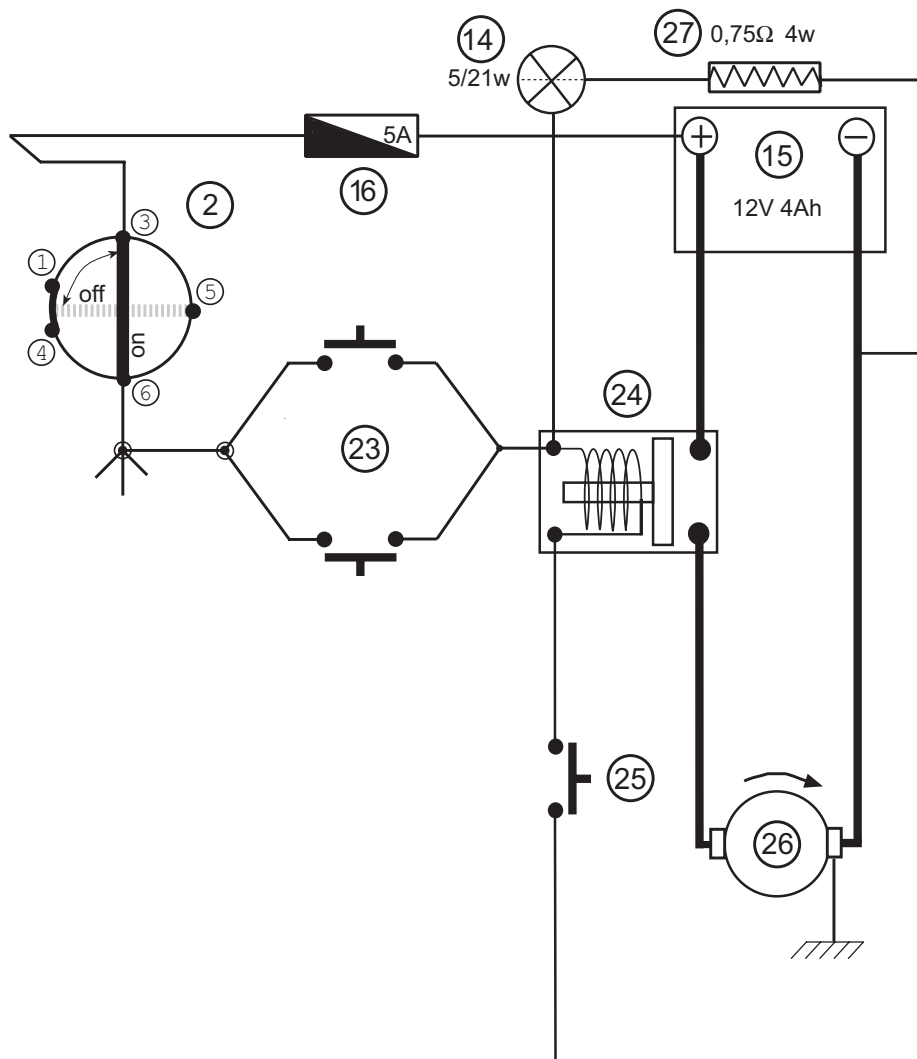

- 2 - Ignition switch
- 14 - Rear and stop light
- 15 - Battery
- 16 - 5A Fuse
- 23 - Stop contact switch
- 24 - Starter motor relay
- 25 - Starter motor control
- 26 - Starter motor
- 27 - Current limiter





- A** Instrument panel lighting
- B** Headlamp telltale
- C** Low oil level telltale
- D** Indicator telltale
- E** Fuel gauge receiver
  
- 1** Flywheel
  - a* ignition
  - b* sensor
  - c* alternative current
  - d* battery charge current
  
- 2** Ignition switch
- 3** CDI ignition unit
- 4** High voltage coil
- 5** Interference suppresser 5 KW
- 6** Spark plug 5 KW
- 7** Regulator, rectifier
  - a* regulator (AC)
  - b* regulator, rectifier (DC)
  
- 8** Choke
- 9** Resistance 6,7 W - 5 W
- 10** Lighting control
- 11** Resistance 5,9 W - 30 W
- 12** Headlamp control
- 13** Headlamp bulb
- 14** Rear and stop light bulb
- 15** Battery
- 16** Fuse
- 17** Horn
- 18** Horn button
- 19** Turn signal relay
- 20** Indicator control
- 21** Indicator bulbs
- 22** Fuel gauge
- 23** Stop light contact switches
- 24** Starter motor relay
- 25** Starter motor control
- 26** Starter motor
- 27** Current limiter
- 28** Low oil level contact switch
- 33** Number\* plate lighting

\* According to the model





# INTRODUCTION

This workshop manual concerns the FB engine which is fitted on several 50cm<sup>3</sup> vehicles on the air-cooled version:

- FB0 ..... ZENITH
- FB1 ..... BUXY - SPEEDAKE
- FB2 ..... SQUAB - TREKKER
- FB4 ..... SPEEDFIGHT - TREKKER ROAD

The electric part of this manual only concerns the TREKKER and SQUAB vehicle ranges.

## PEUGEOT MOTOCYCLES RECOMMENDS

### 2 STROKE OIL

 - ESSO 2T SPECIAL ..... 1 LITRE ..... Ref. : 753752

 - ESSO 2T SYNTHETIC ..... 1 LITRE ..... Ref. : 753759

### TRANSMISSION CASE OIL

 - GEAR OIL GX-SAE 80W-90 ... 2 LITRES ..... Ref. : 753009

### HIGH TEMPERATURE GREASE

 - SKF LGHT 3/0.4 ..... Ref. : 752093

### GREASE

 - MULTI-PURPOSE ..... Grease 4746

TIME SAVINGS = MONEY SAVINGS



PEUGEOT MOTOCYCLES  
SYSTÈME QUALITÉ  
CERTIFIÉ ISO 9001



recommends



Dans un souci constant d'amélioration Peugeot Motocycles se réserve le droit de modifier, supprimer ou ajouter toute référence citée  
DC/PS/SH Imp. en U.E. 10/07/98

N° 11.753784.00

## Free Manuals Download Website

<http://myh66.com>

<http://usermanuals.us>

<http://www.somanuals.com>

<http://www.4manuals.cc>

<http://www.manual-lib.com>

<http://www.404manual.com>

<http://www.luxmanual.com>

<http://aubethermostatmanual.com>

Golf course search by state

<http://golfingnear.com>

Email search by domain

<http://emailbydomain.com>

Auto manuals search

<http://auto.somanuals.com>

TV manuals search

<http://tv.somanuals.com>