

# SM400i

## Surface-Mount Speaker

Technical Information for System Engineers



**SOUNDTUBE**  
ENTERTAINMENT



### Specifications: SM400i

### Mounting hardware included

System Type	4" Coaxial, surface mount, ported (25/70.7/100 Volt or voice coil / 4 Ohm direct)
Frequency Response (-3 dB) <sup>1</sup>	92 Hz - 22 kHz
Low Frequency (-10 dB) <sup>1</sup>	73 Hz
Max. Program Power	40 Watts
Max. Continuous Power RMS <sup>2</sup>	20 Watts
Max. SPL dB @ 1 M	98 dB
Sensitivity dB @ 1W/1M (2.83V) <sup>3</sup>	88.5 dB
Sensitivity dB @ 1W/1M <sup>4</sup>	85 dB
Impedance (nominal)	4 Ohm
Coverage Angle (-6 dB @ 2 kHz)	92°
Coverage Angle (-6 dB @ 10 kHz)	71°
Directivity Factor (Q)	2.89 (Averaged 100 Hz - 10 kHz); 5.1 @ 2 kHz
Directivity Index (DI)	4.0 dB (Averaged 100 Hz - 10 kHz); 7.0 dB @ 2 kHz
Tap Selector	Weather-proof 5-position tap switch with voice coil/4 Ohm direct position

### Transformer Taps

70.7 V	Output	100 V	Output	25 V	Output
20w	98.0dB	20w	98.0dB	3w	89w
10w	94.9dB	10w	94.9dB	1w	86w
5w	91.9dB	5w	91.9dB	0.63w	83w
3w	88.9dB			0.31w	80w

### Transducers

Low-Frequency Driver	1 x 102mm (4in) Polypropylene cone, butyl rubber surround
High-Frequency Driver	25mm (1in) Convex aluminum tweeter with waveguide
Low Frequency Voice Coil	25 mm (1 in)
Crossover Frequency	2.27 kHz

### Network Type

Low Pass	12 dB per octave, 2nd order
High Pass	12 dB per octave, 2nd order
Enclosure Material	Injection molded ABS, glass fiber reinforced
Grille Material	Iridite-plated aluminum with powder-coat finish
Inputs	4 Pin, 5 mm Euroblock for individual or daisy chain connection
Color Options	Black, white or custom colors available
Width	177 mm / 6.97 in
Height	246 mm / 9.68 in
Depth (Including Bracket)	190 mm / 7.47 in
Weight	1.8 kg / 3.9 lb
Shipping Weight	3.2 kg / 7.1 lb

### Accessories

Included	Corrosion- & theft resistant u-bracket mount with safety cable, Euroblock connector, terminal weather boot, port plugs.
Optional	Paint mask
Packaging	1 per box

### Key Features

- BroadBeam<sup>®</sup> waveguide technology delivers a consistent dispersion pattern up to 10 kHz for maximum coverage area per speaker (EASE<sup>™</sup> documented).
- One 102 mm (4 in) polypropylene woofer and one 25 mm (1 in) convex aluminum tweeter with FerroFluid cooling.
- Weatherized components for indoor & outdoor applications.
- Patented ZeroReflection<sup>™</sup> enclosure technology for optimal sound reproduction & cabinet rigidity.
- Easy access 5-position selectable tap switch for 25, 70.7 and 100 Volt applications with voice coil/4 Ohm direct simplifies ordering & inventory tracking.
- Iridite-plated aluminum grille with protective powder-coated finish for lasting durability.
- Weatherized components for indoor / outdoor applications. Includes a tool-free Stealth<sup>™</sup> u-bracket mounting system for fast & secure installation. Included accessories: Mounting hardware, Euro-block connector, & terminal weather boot.
- Vertical and horizontal mounting offer precision aiming for indoor & outdoor applications.
- High quality black or white paint finish. Custom colors available.
- Optional port plugs are included for added weather resistance.

### Description

The SM400i is a 4" coaxial, ported speaker with a low-profile surface-mount enclosure design for indoor/outdoor applications. Mounting hardware is included & features a corrosion- and theft-resistant Stealth-Bracket<sup>™</sup> for easy & secure installation. Nearly invisible from sightlines, the Stealth-Bracket<sup>™</sup> includes uni-direction fasteners for tool-free, theft-resistant security. SoundTube's custom-engineered driver and electro-acoustic network deliver high-performance sound in a cost-effective surface-mount speaker design. The SM400i speaker incorporates a 5-position tap switch with voice coil/4 Ohm direct for simplified ordering and stocking. Provided port plugs can be used for added weather resistance.

<sup>1</sup> Frequency response is measured in Full space.

<sup>2</sup> Continuous power rating, EIA-426-B test.

<sup>3</sup> Average over published frequency response range.

<sup>4</sup> 1w/1m sensitivity based on voltage required to yield 1w based on the minimum system impedance.

SoundTube continually develops new product innovations and improvements. Updates to existing products without prior notice are an example of SoundTube's drive for constant improvement.

**Frequency Response**

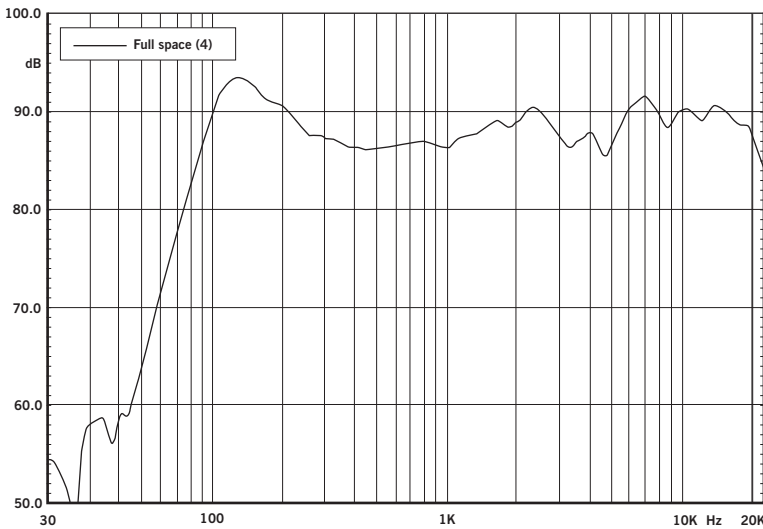

**Applications**

Engineered with professional grade components, the SM400i delivers high-quality music and messaging for indoor & outdoor background to mid-level SPL applications. Cost-effective engineering with high-performance sound makes the SM400i speaker ideal for applications including retail, grocery stores, restaurants, hotels, casinos, museums, trade shows & conference rooms. For applications where additional bass is required, SoundTube's RS801i 8" subwoofer provides bass down to 40 Hz.

**BroadBeam® Wide Dispersion Technology**

More than 3 years in development, SoundTube's proprietary BroadBeam® technology incorporates a high-frequency waveguide mated to a 1" convex metal tweeter. BroadBeam® waveguide technology delivers a consistent BroadBeam® dispersion pattern across the upper registers of the frequency

**Phase/Impedance Reponse**

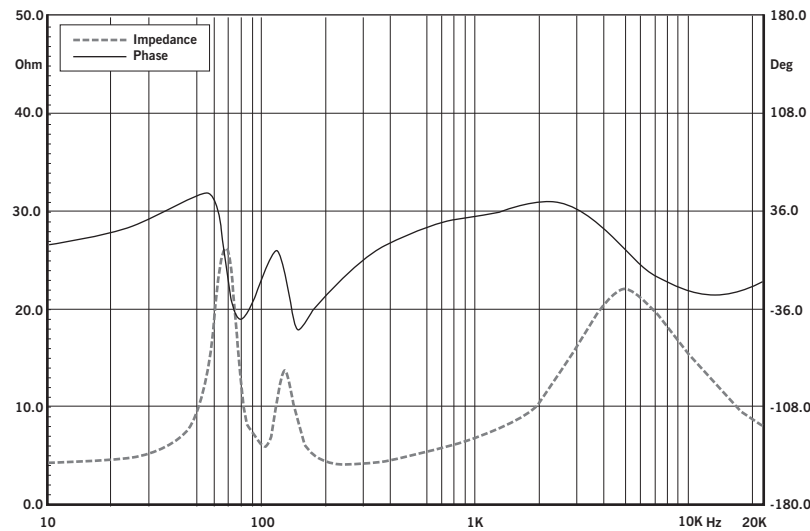

**Beamwidth (-6dB)**

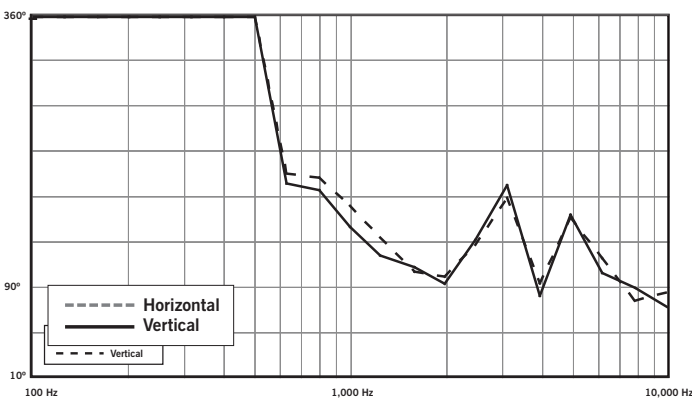

**Directivity Index (DI)**

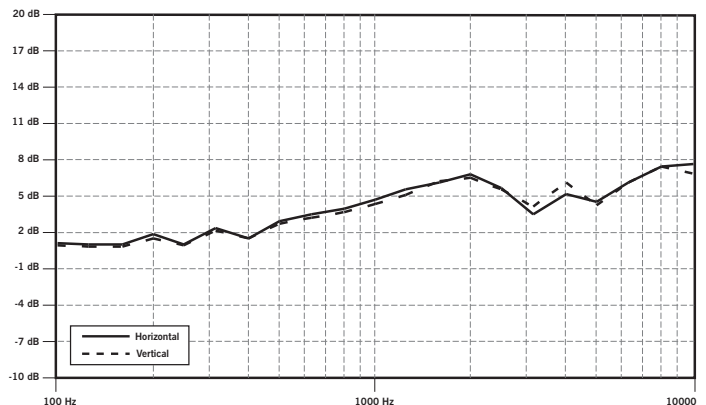

spectrum (up to 10 kHz, EASE™ documented). The result is an audio system with fewer speakers, reduced power needs, shorter installation time and cost savings on shipping & labor.

**Patented SoundTube Technologies**

SoundTube Entertainment is constantly developing new technologies that enhance audio product performance. SoundTube Entertainment innovations are protected by multiple U.S. & international patents, which explicitly cover SoundTube dome, enclosure and dispersion technologies. SoundTube Entertainment actively defends its patents in order to protect SoundTube resellers and end users.

**Technical Data and Specification Tools**

**Technical Data**

SoundTube Entertainment strives to provide complete and effective technical information and data to dealers, engineers and designers. All data are available from SoundTube Entertainment or at [www.soundtube.com](http://www.soundtube.com).

**Data Acquisition**

All performance data acquired at SoundTube's Technical Measurement Center (TMC) are analyzed using a variety of standard measurement techniques, including Measured Length Sequence (MLS) and Time Delay Spectrometry (TDS). Performance, development and data acquisition tools include: Gold Line TEF 20, CLIO, LMS, LEAP, and proprietary modeling software. EASE™ data are acquired through an automated TEF 20/Outline/EASE™ interface.

**EASE™ Data** – 3-D polar plots.

**SoundTubeSPEC™** – Proprietary SoundTube speaker placement software.

**Technical assistance: SoundTube SPEC™ software and engineering support**

For quick and easy specification, visit [www.soundtube.com](http://www.soundtube.com) and use SoundTube's proprietary specification software. For technical assistance, including detailed EASE™ plots, contact SoundTube Entertainment directly

at [techinfo@soundtube.com](mailto:techinfo@soundtube.com) or call us at 435-647-9555 or 800-647-8823.

**Architectural Specifications**

The loudspeaker shall consist of a 102 mm (4 in) polypropylene woofer and one 25 mm (1 in) convex aluminum tweeter with Ferro-Fluid cooling.

Performance specifications of a typical production unit shall be as follows: Useable frequency response shall extend to 73 Hz (-10 dB, full space, no external equalization). Measured sensitivity (2.83 Volt input, 1 meter) shall be at least 88.5 dB. The speaker shall have a nominal impedance of 4 Ohms and be available for 25, 70.7 & 100 Volt modes with voice coil/4 Ohm direct. The frequency dividing network shall have a crossover frequency of 2.27 kHz with slopes of 12 dB per octave (2nd order) for both low and high pass filters. Rated power capacity shall be at least 20 Watts continuous power (RMS) and conform to EIA-426-B testing. Maximum continuous output at 1 meter shall be 98 dB.

The low-frequency transducer shall have a polypropylene cone with butyl rubber surround. The high-frequency transducer shall

**Polar Plots**

**125 Hz**

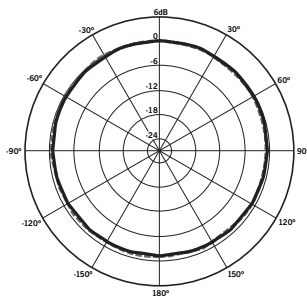

**250 Hz**

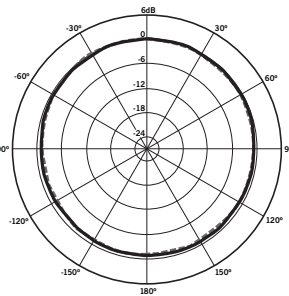

**500 Hz**

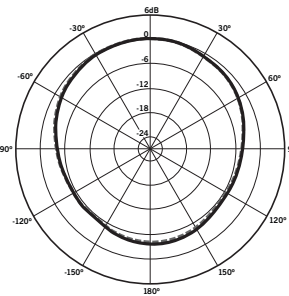

**1,000 Hz**

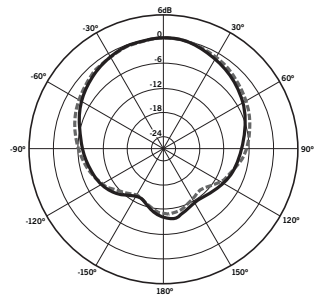

**2,000 Hz**

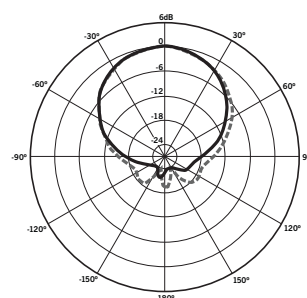

**4,000 Hz**

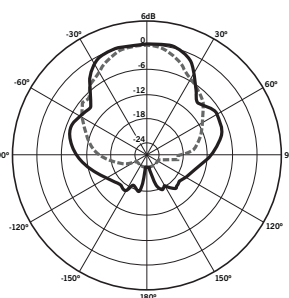

**8,000 Hz**

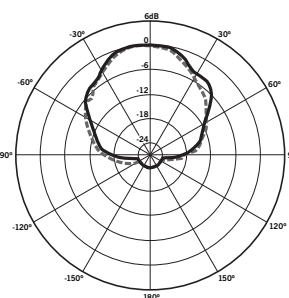

**10,000 Hz**

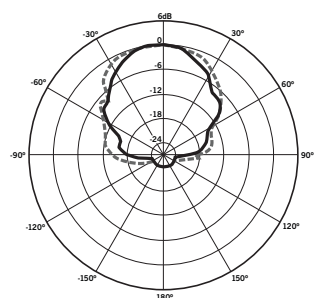

----- Horizontal  
 \_\_\_\_\_ Vertical



### Mechanical Drawings

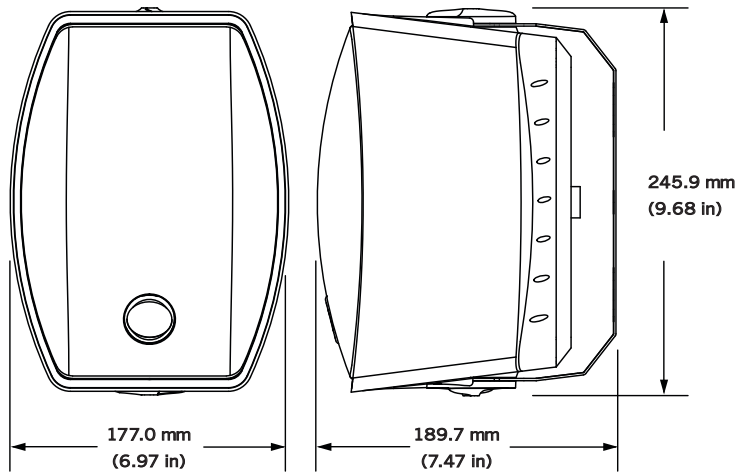

be constructed of aluminum with a proprietary BroadBeam® waveguide.

Installation and safety attachment for the SM400i shall be by Stealth U-bracket affixed to the speaker chassis via ABS handle with steel insert and come with a safety cable for seismic and safety redundancy. The external wiring input connector shall be a 4-pin, 5 mm Euroblock for 4 Ohm or distributed systems and shall accept from 10 – 22 gauge wire. The system shall be for indoor & outdoor applications and shall have a weather-resistant terminal boot covering all wire connectors.

The enclosure shall be constructed of injection-molded ABS with optional port plug for added weather resistance. The plugs shall be constructed of closed-cell foam. The grille shall be constructed of iridite-plated, powder-coated aluminum for lasting performance in the elements. The SM400i shall include mounting hardware, Euroblock connector and weather-resistant terminal boot. The maximum overall cabinet dimensions shall be 245.9 mm (9.68 in) in height by 177.0 mm (6.97 in) in width by 189.7 mm (7.47 in) in depth (including Stealth™ bracket)

The system shall be the SoundTube SM400i with mounting hardware for both low & high impedance applications.

### SoundTube Entertainment

6430 North Business Park Loop  
Park City, Utah 84098  
Phone 435.647.9555  
Fax 435.647.9666  
Toll Free 800.647.TUBE  
www.soundtube.com

**All SoundTube products come with a 5-year limited warranty.**

## Free Manuals Download Website

<http://myh66.com>

<http://usermanuals.us>

<http://www.somanuals.com>

<http://www.4manuals.cc>

<http://www.manual-lib.com>

<http://www.404manual.com>

<http://www.luxmanual.com>

<http://aubethermostatmanual.com>

Golf course search by state

<http://golfingnear.com>

Email search by domain

<http://emailbydomain.com>

Auto manuals search

<http://auto.somanuals.com>

TV manuals search

<http://tv.somanuals.com>