

Register your product and get support at
www.philips.com/welcome

AC4076



User manual

PHILIPS



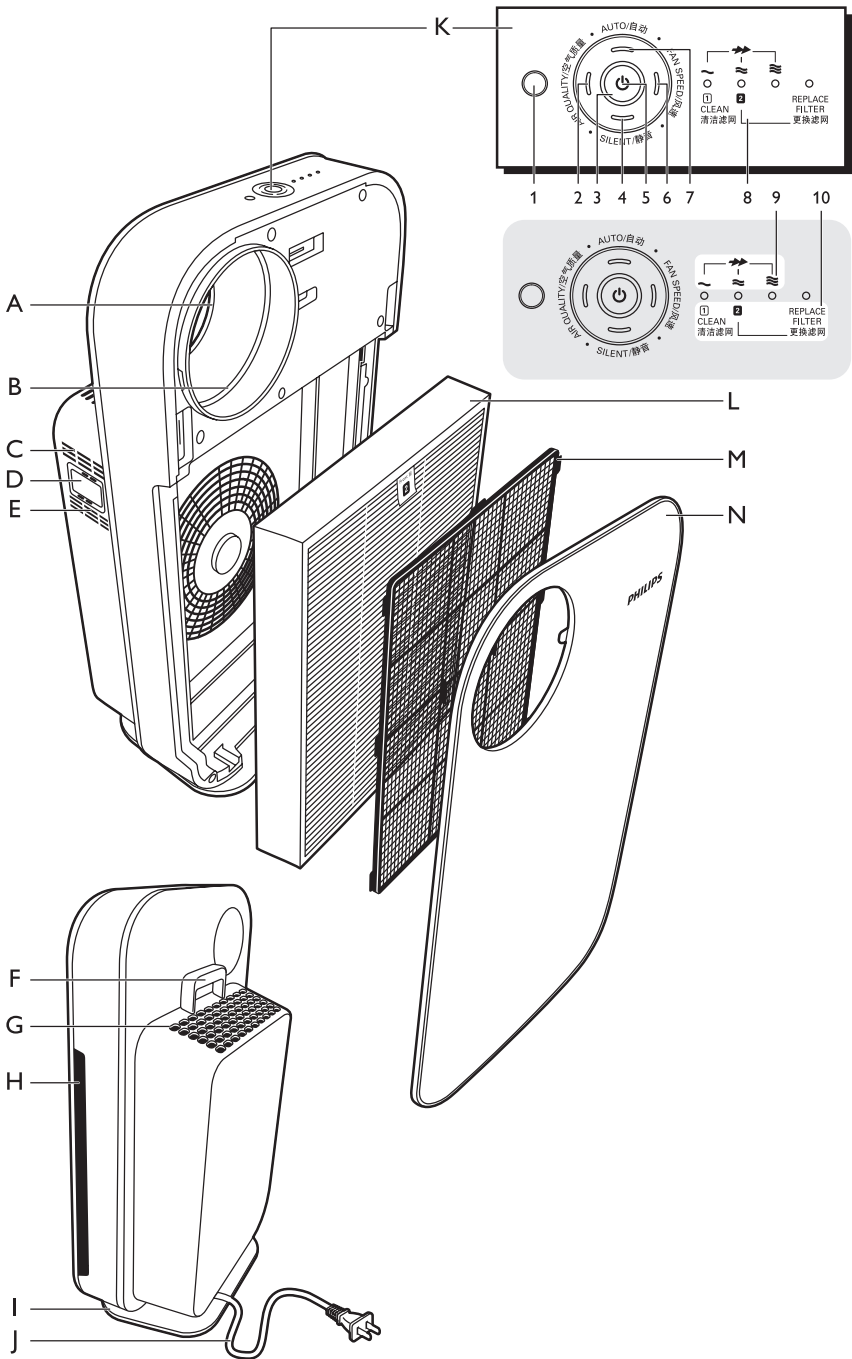

Introduction

Congratulations on your purchase and welcome to Philips! To fully benefit from the support that Philips offers, register your product at www.philips.com/welcome.

With this new home air purifier, you breathe cleaner air in your new or newly decorated home. For the best result, place the New home air purifier in a room where you spend most of your time, e.g. your bedroom, living room, or children's room.

There are many pollution sources. In a new or newly decorated home, there is high condensation of formaldehyde and other harmful gases coming from furniture, paints and smoking, and etc. Because of these harmful gases are invisible and odorless, they can affect your health. The New home air purifier filters off these harmful gases quickly and effectively. Furthermore, it can also filter out pollutants such as pollens, airborne particles that can affect your well-being. With our new home air purifier, it improves the air quality and ensures you and your family members breathe cleaner air at your home.

Filtration in a professional and credible way

The new home air purifier has all-in-one High capacity formaldehyde new home filter that ensures the best air quality in your new or newly decorated home:

- Stage 1: The pre-filter has been treated with antibacterial substances. It catches big particles like human hair, pet hair etc.
- Stage 2: The high capacity formaldehyde new home filter* effectively removes formaldehyde, odors, and other volatile organic compounds (VOCs).

* New home filter AC4147 supplied with AC4076 and AC4016.

General description (Fig. 1)

- A Air quality light ring
- B Fan speed indicator
- C Air quality sensor outlet
- D Air quality sensor
- E Air quality sensor inlet
- F Handle
- G Air outlet
- H Air inlet
- I Cord storage facility
- J Mains cord
- K Control panel
- 1 Light sensor for night mode
- 2 AIR QUALITY on/off button with light
- 3 Power on/off button
- 4 SILENT button with light
- 5 Power-on button with light
- 6 FAN SPEED button with light
- 7 AUTO button with light
- 8 Fan speed lights (1, 2, 3 and boost power)/filter replacement lights
- 9 FAN SPEED indications
- 10 REPLACE FILTER indications
- L Filter 2: High capacity formaldehyde / particle new home filter

- M Filter 1: pre-filter
- N Front panel

Important

Read this user manual carefully before you use the appliance and save it for future reference.

Danger

- Do not let water or any other liquid or flammable detergent enter the appliance to avoid electric shock and/or a fire hazard.
- Do not clean the appliance with water or any other liquid or a (flammable) detergent to avoid electric shock and/or a fire hazard.

Warning

- Check if the voltage indicated on the bottom of the appliance corresponds to the local mains voltage before you connect the appliance.
- If the mains cord is damaged, you must have it replaced by Philips, a service centre authorised by Philips or similarly qualified persons in order to avoid a hazard.
- Do not use the appliance if the plug, the mains cord or the appliance itself is damaged.
- This appliance is not intended for use by persons (including children) with reduced physical, sensory or mental capabilities, or lack of experience and knowledge, unless they have been given supervision or instruction concerning use of the appliance by a person responsible for their safety.
- Children should be supervised to ensure that they do not play with the appliance.
- Do not block the air inlet and outlet, e.g. by placing items on the air outlet or in front of the air inlet.

Caution

- This appliance is not a substitute for proper ventilation, regular vacuum cleaning or use of an extractor hood or fan while cooking.
- If the wall socket used to power the appliance has poor connections, the plug of the appliance becomes hot. Make sure you plug the appliance into a properly connected wall socket.
- Always place and use the appliance on a dry, stable, level and horizontal surface.
- Leave at least 20cm free space behind and on both sides of the appliance and leave at least 30cm free space above the appliance.
- Do not place anything on top of the appliance and do not sit on the appliance.
- Do not place the appliance directly below an air conditioner to prevent condensation from dripping onto the appliance.
- Make sure all filters are properly installed before you switch on the appliance.
- Only use the original Philips filters specially intended for this appliance. Do not use any other filters.
- Avoid knocking against the appliance (the air inlet and outlet in particular) with hard objects.
- Always lift or move the appliance by the handle at the back of the appliance.
- Do not insert your fingers or objects into the air outlet.
- Do not use this appliance when you have used indoor smoke-type insect repellents or in places with oily residues, burning incense or chemical fumes.
- Do not use the appliance near gas appliances, heating devices or fireplaces.

- Always unplug the appliance after use and before you clean it.
- Do not use the appliance in a room with major temperature changes, as this may cause condensation inside the appliance.
- The appliance is only intended for household use under normal operating conditions.
- Do not use the appliance in wet surroundings or in surroundings with high ambient temperatures, such as the bathroom, toilet or kitchen.
- The appliance does not remove carbon monoxide (CO) or radon (Rn). It cannot be used as a safety device in case of accidents with combustion processes and hazardous chemicals.

Electromagnetic fields (EMF)

This Philips appliance complies with all applicable standards and regulations regarding exposure to electromagnetic fields.

Before first use

Placing the filters

The appliance comes with all filters fitted inside, but you have to remove the packaging of the filters before you can use the appliance. Remove all filters, unpack them and place them back into the appliance as described below.

Tip: Place the appliance against a wall for more stability when you remove or insert filters.

Note: Make sure you insert the filters in the correct position.

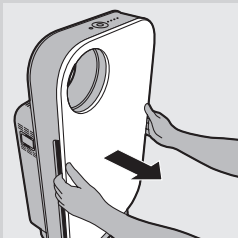

- 1** Place your fingers in the recesses of the side panels and gently pull the top part of the front panel towards you. Then lift the hooks at the bottom of the panel out of the bottom of the appliance.

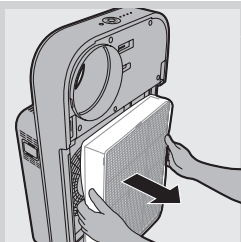

2 Remove the filters from the appliance.

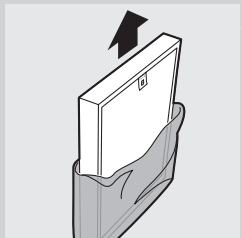

3 Take out the new filter from the packaging material.

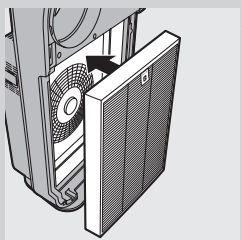

4 Put filter 2 (New home filter) back into the appliance.

Note: Make sure that the side with the tag is pointing towards you.

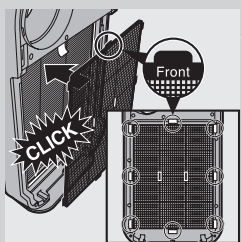

5 Place filter 1 (pre-filter) in the appliance.

Note: Make sure that the side with the two projections is pointing towards you.

Note: Make sure that all hooks are properly attached to the appliance.

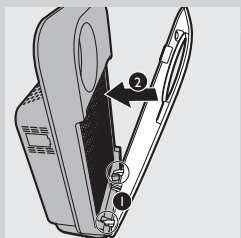

6 To reattach the front panel, insert the bottom hooks into the bottom of the appliance first (1). Then push the panel against the body of the appliance (2).

Using the appliance

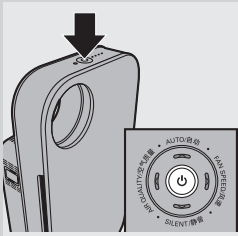

- 1 Put the plug in the wall socket
- ▶ All lights go on twice and you hear a beep. Then the lights go out again.

- 2 Press the on/off button to switch on the appliance.

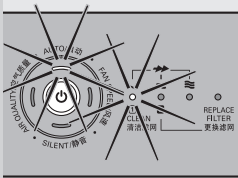

- ▶ The power-on light, the AUTO light, and the AIR QUALITY light on the control panel go on.

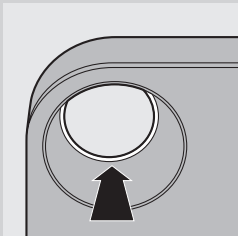

- ▶ The air quality light ring shows the quality of the air.

Air quality indication

Colour	Air quality
Blue	very good
Deep purple	good
Purple	fair
Red	bad

To switch off the air quality light ring, press the AIR QUALITY button.

Note: The air quality light ring automatically goes on when the appliance is switched on.

- ▶ The appliance automatically starts operating in the AUTO mode.

To switch off the appliance, press the on/off button again and unplug the appliance.

Note: When the humidity level in the room is very high, it is possible that condensation develops on the air quality sensor. As a result, the AIR QUALITY light on the control panel and the air quality light ring may indicate that the air quality is bad even though the air quality is good. In this case, the auto

mode causes the appliance to run at high fan speed. You can solve this by cleaning the air quality sensor. If condensation develops frequently during periods of high humidity, we advise you to use one of the manual speed settings.

Fan speed lights/filter replacement lights

- The lights on the right-hand side of the control panel have a dual function: they either indicate the fan speed or they indicate that the filters should be replaced or cleaned.
- When lights 1 to 2 light up continuously, they indicate the current fan speed.
- When light 1 flashes, you have to clean the pre-filter; When lights 2 flashes, you have to replace the New home filter.
- When light 2 and the REPLACE FILTER light are flashing continuously, the New home filter have to replace, and the appliance is locked (see chapter 'Filter replacement lock' for more information).

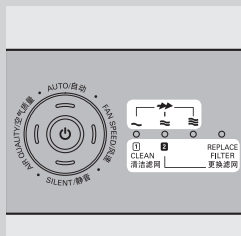

Adjusting the air quality sensor sensitivity

People with certain health problems (e.g. allergies or asthma) have a greater need for healthy air. For this reason, the appliance allows you to adjust the sensitivity of the air quality sensor. If you set it to higher sensitivity level, the appliance starts cleaning the air at lower pollution level.

There are 3 sensitivity levels:

- standard
- sensitive
- extra sensitive

The pollution sensor is set to standard sensitivity by default. You can adjust the sensitivity of the air quality sensor in the following way:

- 1** If the appliance is already plugged in, unplug the appliance and wait for a few minutes.
- 2** Press the AIR QUALITY button and simultaneously put the mains plug in the wall socket.
 - ▶ The appliance beeps twice and one of the fan speed lights flashes to show the current sensitivity level of the air quality sensor.

Sensitivity level:

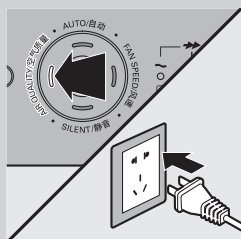

Fan speed light



Sensitivity level

extra sensitive



sensitive



standard

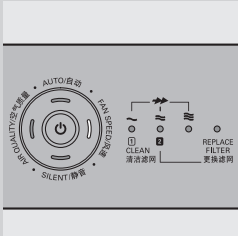

- 3 Press the FAN SPEED button to adjust the sensitivity level of the air quality sensor.
 - ▶ One of the fan speed lights flashes to show the set sensitivity level of the air quality sensor.

- 4 Press the on/off button to switch off the appliance.

Note: When you change the sensitivity level, the appliance automatically starts operating at the set sensitivity level whenever you switch on the appliance.

Auto mode

When the appliance is switched on, the built-in air quality sensor automatically measures the ambient air quality. When the auto mode is activated, the appliance selects the most appropriate fan speed for the measured air quality.

- 1 Press the on/off button to switch on the appliance.
- 2 Press the AUTO button to activate the auto mode.

Note: When the appliance is operating in another mode and you want to activate the auto mode, simply press the AUTO button.

- ▶ The AUTO light goes on.
- ▶ The FAN SPEED light indicates at which fan speed the appliance is operating.

Note: When the air quality is very good and the appliance operates at a very low fan speed, the FAN SPEED light for the lowest speed setting does not go on. In this case only the power-on light and the AUTO light are on.

Note: The built-in air quality sensor measures the air quality and automatically selects the appropriate speed setting to ensure the best possible air quality in your room. When the air is clean, the appliance stops running. When the air quality deteriorates, the appliance starts running at a low fan speed and noise level so that the energy consumption is minimised.

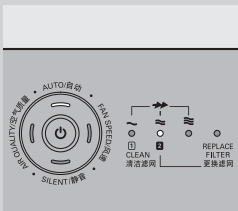
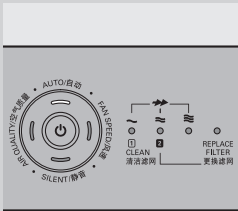

Night mode

The appliance works in harmony with its surroundings. In auto mode, the appliance automatically switches to night mode when the room in which it is operating becomes dark. When the room has been dark for 3 minutes, the lights of the appliance go out, the fan speed and noise level are reduced and the energy consumption is minimised. If the room becomes bright again for 5 minutes or longer, the appliance resumes normal operation.

In night mode, the automatic control is still active. If the air is clean, the lights and the fan are off. If the air quality deteriorates, the appliance is activated and the lights and the fan come on again.

Note: *The night mode only works when the appliance is operating in the auto mode.*

Fan speed

If you do not use the auto mode, you can select the desired fan speed yourself.

- 1 Press the on/off button to switch on the appliance.
- 2 Press the FAN SPEED button one or more times to select the desired fan speed.
 - ▶ The corresponding fan speed light and the indications above the lights show the set fan speed (⋄, ≈, ≡ or ➔).
 - ▶ The corresponding fan speed light in the fan speed indicator goes on.

Note: *Select boost power (➔) if you need an extra strong airflow when the air in the room is very dirty. Lights ⋄ to ≈ light go on.*

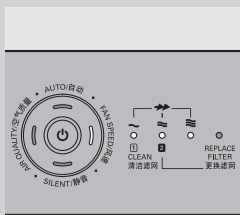
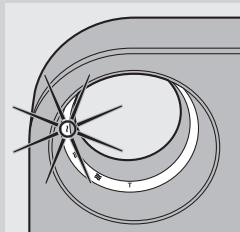
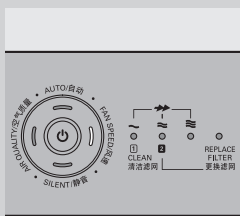

Silent mode

When you use the appliance in silent mode, it operates very quietly.

- 1** Press the on/off button to switch on the appliance.
- 2** Press the SILENT button to activate the silent mode.

▶ The SILENT light goes on.
If you want to go back to the FAN SPEED mode or AUTO mode, simply press the FAN SPEED or AUTO button.

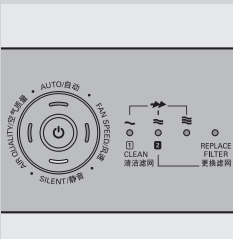

Cleaning

Always unplug the appliance before you clean it.

Never immerse the appliance in water or any other liquid.

Never use aggressive or flammable cleaning agents such as bleach or alcohol to clean any part of the appliance.

Only the pre-filter is washable.

Body of the appliance

Regularly clean the inside and outside of the body to prevent dust from collecting on the inside and outside.

- 1** Wipe away dust with a soft dry cloth from the body of the appliance.
- 2** Clean the air inlet and the air outlet with a soft dry cloth.

Pre-filter

The pre-filter is washable.

- Clean the pre-filter when the first filter replacement light flashes to ensure optimal functioning of the appliance.

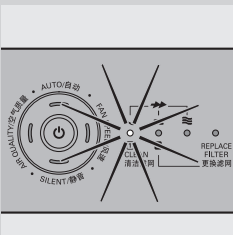

- 1** Place your fingers in the recesses of the side panels and gently pull the top part of the front panel towards you. Then lift the hooks at the bottom of the panel out of the bottom of the appliance.



2 To remove the pre-filter, grab the two projections and pull the filter towards you.

3 Wash the pre-filter under a running tap. If the pre-filter is very dirty, use a soft brush to brush away the dust.

Tip: Alternatively, you can clean the pre-filter by removing the dust with a vacuum cleaner.

4 Air-dry the pre-filter.

Note: Make sure that the pre-filter is completely dry. If it is still wet, bacteria may multiply in it and shorten the lifetime of the pre-filter.

5 Put the pre-filter back into the appliance. Attach all hooks properly to the appliance.

Note: Make sure that the side with the two projections is pointing towards you.

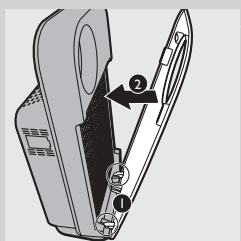
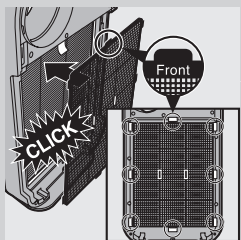

6 To reattach the front panel, insert the bottom hooks into the bottom of the appliance first (1). Then push the panel against the body of the appliance (2).

Air quality sensor

Clean the air quality sensor every 2 months for optimal functioning of the appliance. Clean it more frequently if you use the appliance in a dusty environment.

Note: When the humidity level in the room is very high, it is possible that condensation develops on the air quality sensor. As a result, the AIR QUALITY light on the control panel and the air quality light ring may indicate that the air quality is bad even though the air quality is good. In this case you have to clean the air quality sensor or use one of the manual speed settings.

1 Clean the air quality sensor inlet and the air quality sensor outlet with a soft brush.

2 Remove the air quality sensor cover.

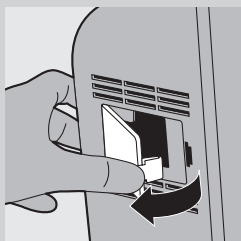
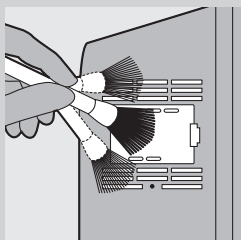

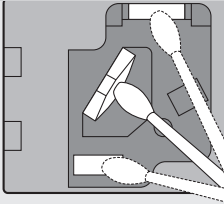

- 3** Clean the air quality sensor, the dust inlet and the dust outlet with a lightly moistened cotton swab.
- 4** Dry them with a dry cotton swab.
- 5** Reattach the air quality sensor cover.

Filter replacement

Filter maintenance

This appliance is equipped with the Healthy air protect lock to ensure that the filters are in optimal condition when the appliance is operating. When one of the filters is almost full and has to be cleaned or replaced, the appropriate filter replacement light starts to flash. When you do not replace the New home filter, the appliance stops operating and the appliance is locked.

When the appliance is locked, the filter replacement light of the filter concerned lights up continuously.

Note: Only replace a filter when the filter replacement light flashes. If you replace the filter before the filter replacement light starts flashing, the lifetime counter will not be reset but will continue counting the lifetime of the previous filter. As a result, the filter replacement light will start flashing much too soon.

Filter replacement lights

The filter replacement lights indicate which filter has to be cleaned or replaced.

- Filter replacement light 1 flashes: filter 1 (the pre-filter) has to be cleaned. See chapter 'Cleaning' for further instructions.
- Filter replacement light 2 flashes: the New home filter has to be replaced.

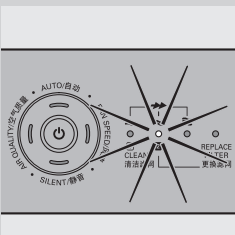
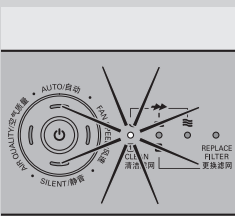

Healthy air protect lock

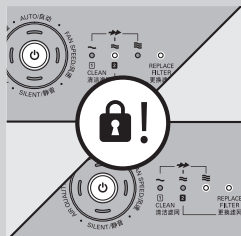

If you do not replace the filter in time, the appliance stops operating approx. 2 weeks after the filter replacement light started flashing. When the appliance is locked, it does not operate until you have replaced with the new filter and pressed the reset button.

Note: When filter replacement lights 2 and REPLACE FILTER on the control panel are on continuously, the appliance is locked (see section 'Filter maintenance' in this chapter for more information).

How long it takes before the appliance is locked depends on the operating time and speed level selected after the filter replacement alert.

Approximately 1 day before the appliance locks, it beeps every 30 minutes to inform you that one of the filters needs to be replaced.

When the appliance is locked, you hear a beep when you press any button. You can switch off the appliance by pressing the on/off button.

If the appliance is locked:

- 1** Check which filter needs to be replaced (see section 'Filter replacement lights').
- 2** Switch off the appliance and unplug it.
- 3** Replace the appropriate filter (see section 'Replacing the filters').

Replacing the filters

Tip: Place the appliance against a wall for more stability when you remove or insert filters.

- 1** Switch off the appliance and unplug it.
- 2** Place your fingers in the recesses of the side panels and gently pull the top part of the front panel towards you. Then lift the hooks at the bottom of the panel out of the bottom of the appliance.
- 3** To remove filter 1 (pre-filter), grab the two projections and pull the filter towards you.
- 4** To remove filter 2 (New home filter), grab its tag and pull it towards you.
- 5** Discard the filter that needs to be replaced and unpack the new filter.

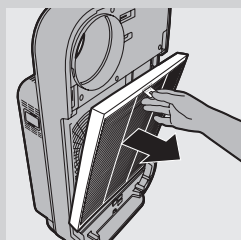
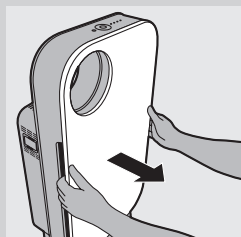

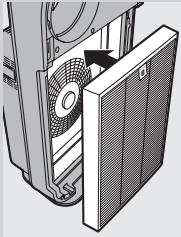

- 6** Put filter 2 (New home filter) back into the appliance.

Note: Make sure that the side with the tag is pointing towards you.

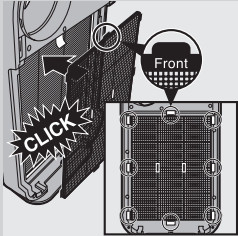

- 7** Put filter 1 (pre-filter) back into the appliance.

Note: Make sure that the side with the two projections is pointing towards you.

Note: Make sure that all hooks are properly attached to the appliance.

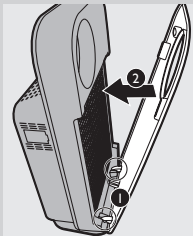

- 8** To reattach the front panel, insert the bottom hooks into the bottom of the appliance first (1). Then push the panel against the body of the appliance (2).

- 9** Put the plug in the wall socket and switch on the appliance again.

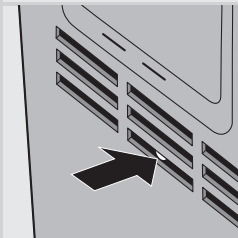

- 10** Press the filter reset button with a thin tool.

Note: You do not need to press the filter reset button after cleaning filter 1 (pre-filter).

Note: You cannot reset the appliance when you replace a filter before its filter replacement light starts flashing.

Note: You cannot reset the appliance if it is not plugged in and switched on.

Storage

To store the mains cord, wind it round the cord storage facility at the bottom of the appliance.

Accessories

New filters are available under the following type numbers:

Filter	Type number
Filter 2: High Capacity Formaldehyde / Particle New Home filter	AC4147

Environment



- Do not throw away the appliance with the normal household waste at the end of its life, but hand it in at an official collection point for recycling. By doing this, you help to preserve the environment.

Guarantee and service

If you need information or if you have a problem, please visit the Philips website at www.philips.com or contact the Philips Consumer Care Centre in your country (you find its phone number in the worldwide guarantee leaflet). If there is no Consumer Care Centre in your country, go to your local Philips dealer.

Troubleshooting

This chapter summarises the most common problems you could encounter with the appliance. If you are unable to solve the problem with the information below, contact the Consumer Care Centre in your country.

Problem	Possible solution
Buttons are not responding.	Replace the New home filter when the filter replacement light started flashing and the appliance has sounded every 30 minutes after approx. 2 weeks. Replace the filter and reset the appliance (see chapter 'Filter replacement') so that the appliance can operate again.
No air comes out of the air outlet	The appliance is not switched on. Put the plug in the wall socket and switch on the appliance. The air quality is good and the auto mode is activated. In this case, the appliance switches off automatically when the air is clean to save electricity.
The fan speed does not change when the AUTO mode is activated.	When the room becomes dark, the night mode is activated automatically when the appliance is in auto mode. In this case, the fan speed is set to a very low level. If you want to change the fan speed, press the FAN SPEED button one or more times to set the desired fan speed.
The airflow that comes out of the air outlet is significantly weaker than before.	The pre-filter is dirty. Clean the pre-filter (see chapter 'Cleaning').
	You haven't removed all packaging material from the filters. Make sure that you have removed all packaging material.
The air quality does not improve, even though the appliance has been operating for a long time.	One of the filters has not been placed in the appliance. Make sure that all filters are properly installed in the following order; starting with the innermost filter: 1) New home filter; 2) pre-filter.

Problem	Possible solution
	The air quality sensor is wet. The humidity level in your room is high and causes condensation. Make sure that the air quality sensor is clean and dry (see chapter 'Cleaning').
The colour of the air quality light ring and the air quality light always stays the same.	The air quality sensor is dirty. Clean the air quality sensor (see chapter 'Cleaning').
	There is not enough ventilation in the room. Open a window, to improve the air circulation.
I need cleaner air because I have an allergy.	You can change the air quality sensor sensitivity (see chapter 'Using the appliance') to make the appliance clean the air even better.
The appliance is extra loud.	You haven't removed all packaging material from the filters. Make sure that you have removed all packaging material.
The appliance still indicates that I need to replace a filter, but I already did.	Perhaps you did not press the filter reset button properly. Plug in the appliance, press the on/off button and press the filter reset button with a flat tool.
The appliance stops operating, although the power-on light is still on.	The built in quality sensor has determined that the air quality is good and that the air does not need to be cleaned anymore. When the air quality deteriorates, the appliance starts running at a low fan speed and noise level so that the energy consumption is minimised.
The appliance does not work. Fan speed lights 1 and 2 flash, all other lights are out.	This is a component defect. Contact the Consumer Care Centre in your country (you find its phone number in the worldwide guarantee leaflet). If there is no Consumer Care Centre in your country, go to your local Philips dealer.
The appliance does not work. The air quality light ring flashes blue, all other lights are out.	This is air particle sensor error or an air particle sensor and gas sensor error. Contact the Consumer Care Centre in your country (you find its phone number in the worldwide guarantee leaflet). If there is no Consumer Care Centre in your country, go to your local Philips dealer.
The air quality light ring keeps flashing purple.	This is a gas sensor error. Switch off the appliance and unplug it. Take the appliance to your Philips dealer or an authorised Philips service centre.



© 2013 Koninklijke Philips N.V.

All rights reserved.

3140 035 26574

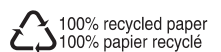

Free Manuals Download Website

<http://myh66.com>

<http://usermanuals.us>

<http://www.somanuals.com>

<http://www.4manuals.cc>

<http://www.manual-lib.com>

<http://www.404manual.com>

<http://www.luxmanual.com>

<http://aubethermostatmanual.com>

Golf course search by state

<http://golfingnear.com>

Email search by domain

<http://emailbydomain.com>

Auto manuals search

<http://auto.somanuals.com>

TV manuals search

<http://tv.somanuals.com>