

MODEL 3905



E-MAXX

TRAXXAS

OWNERS MANUAL

INTRODUCTION

- 3 BEFORE YOU PROCEED
- 4 SAFETY PRECAUTIONS
- 5 TOOLS, SUPPLIES AND REQUIRED EQUIPMENT
- 6 ANATOMY OF THE E-MAXX
- 7 QUICK START: GETTING UP TO SPEED
- 8 DECORATING YOUR MODEL
- 9 THE TRAXXAS TQ RADIO SYSTEM
- 15 ADJUSTING THE ELECTRONIC SPEED CONTROL
- 17 DRIVING YOUR MODEL
- 20 TUNING ADJUSTMENTS
- 25 MAINTAINING YOUR MODEL
- 26 TROUBLESHOOTING
- 27 INDEX

Thank you for purchasing the new Traxxas E-Maxx electric monster truck. When it comes to gut-wrenching, wheelie-popping monster torque, nothing comes close to E-Maxx. We are confident you will appreciate the latest performance and appearance enhancements that have been made to this legendary model. With tough twin Titan® 550 motors and a powerful EVX-2 electronic speed control, the E-Maxx is built for rock-stomping action. The new chassis and water-resistant electronics are made to take abuse. Even innovative technology from our top-of-the-line Revo® has found it's way into E-Maxx in the form of the patent-pending Torque-Control™ slipper and sealed driveshafts.

This manual contains the instructions you will need to operate, and maintain your model so that you can enjoy it for years to come. We want you to feel confident that you own one of the best-performing models in the market and that it is backed by a team of professionals who aim to provide the highest level of factory support possible. Traxxas models are about experiencing total performance and satisfaction, not just with your model, but also with the company that stands behind it.

We know you're excited about getting your new model on the road, but it's very important that you take some time to read through the Owners Manual. This manual contains all the necessary set-up and operating procedures that allow you to unlock the performance and potential that Traxxas engineers designed into your model. **Even if you are an experienced R/C enthusiast, it's important to read and follow the procedures in this manual.**

Thank you again for going with Traxxas. We work hard every day to assure you the highest level of customer satisfaction possible. We truly want you to enjoy your new model!

Traxxas Support

Traxxas support is with you every step of the way. Refer to the next page to find out how to contact us and what your support options are.



Quick Start

This manual is designed with a Quick Start path that outlines the necessary procedures to get your model up and running in the shortest time possible. If you are an experienced R/C enthusiast you will find it helpful and fast. Be sure and read through the rest of the manual to learn about important safety, maintenance, and adjustment procedures. Turn to page 7 to begin.



BEFORE YOU PROCEED

Carefully read and follow all instructions in this and any accompanying materials to prevent serious damage to your model. Failure to follow these instructions will be considered abuse and/or neglect.

Before running your model, look over this entire manual and examine the model carefully. If for some reason you decide it is not what you wanted, then do not continue any further. **Your hobby dealer absolutely cannot accept a model for return or exchange after it has been run.**

WARNINGS, HELPFUL HINTS, & CROSS-REFERENCES

Throughout this manual, you'll notice warnings and helpful hints identified by the icons below. Be sure to read them!



An important warning about personal safety or avoiding damage to your model and related components.



Special advice from Traxxas to make things easier and more fun.



Refers you to a page with a related topic.

SUPPORT

If you have any questions about your model or its operation, call the Traxxas Technical Support line toll-free at: **1-888-TRAXXAS (1-888-872-9927)***

Technical support is available Monday through Friday from 8:30am to 9:00pm central time. Technical assistance is also available at www.Traxxas.com. You may also e-mail customer support with your question at support@Traxxas.com. Join thousands of registered members in our online community at Traxxas.com.

Traxxas offers a full-service, on-site repair facility to handle any of your Traxxas service needs. Maintenance and replacement parts may be purchased directly from Traxxas by phone or online at www.BuyTraxxas.com. You can save time, along with shipping and handling costs, by purchasing replacement parts from your local dealer.

Do not hesitate to contact us with any of your product support needs. We want you to be thoroughly satisfied with your new model!

Traxxas
1100 Klein Road
Plano, Texas 75074
Phone: 972-265-8000
Toll-free 1-888-TRAXXAS

Traxxas U.K.
P.O. Box 1128
Winterbourne, Bristol
BS36-2SH
England
Phone: 44-117-956-1002

Internet
www.Traxxas.com
E-mail: support@Traxxas.com

Entire contents ©2007 Traxxas. Traxxas, Ready-To-Race, Ready-To-Win, E-Maxx and ProGraphix are trademarks or registered trademarks of Traxxas. Other brand names and marks are the property of their respective holders and are used only for purposes of identification. No part of this manual may be reproduced or distributed in print or electronic media without the express written permission of Traxxas. Specifications are subject to change without notice.

*Toll-free support is available to U.S. residents only.

SAFETY PRECAUTIONS



All instructions and precautions outlined in this manual should be strictly followed to ensure safe operation of your model.



This model is not intended for use by children under 8 years of age without the supervision of a responsible and knowledgeable adult.



Previous experience with radio controlled models is recommended. Models require a higher level of setup, maintenance, or support equipment.



All of us at Traxxas want you to safely enjoy your new model. Operate your model sensibly and with care, and it will be exciting, safe, and fun for you and those around you. Failure to operate your model in a safe and responsible manner may result in property damage and serious injury. The precautions outlined in this manual should be strictly followed to help ensure safe operation. You alone must see that the instructions are followed and the precautions are adhered to.

IMPORTANT POINTS TO REMEMBER

- ⊕ Your model is not intended for use on public roads or congested areas where its operation can conflict with or disrupt pedestrian or vehicular traffic.
- ⊕ Never, under any circumstances, operate the model in crowds of people. Your model is very fast and could cause injury if allowed to collide with anyone.
- ⊕ Because your model is controlled by radio, it is subject to radio interference from many sources that are beyond your control. Since radio interference can cause momentary losses of radio control, always allow a safety margin in all directions around the model in order to prevent collisions.
- ⊕ The motors, batteries, and speed control can become hot during use. Be careful to avoid getting burned.
- ⊕ Don't operate your model at night, or anytime your line of sight to the model may be obstructed or impaired in any way.
- ⊕ **Most importantly, use good common sense at all times.**

BATTERIES AND BATTERY CHARGING

Your model uses rechargeable batteries that must be handled with care for safety and long battery life. Make sure to read and follow all instructions and precautions that were provided with your battery packs and your charger. It is your responsibility to charge and care for your battery packs properly. In addition to your battery and charger instructions, here are some more tips to keep in mind.

- ⊕ Never leave batteries to charge unattended.
- ⊕ Remove the batteries from the model while charging.
- ⊕ Always unplug the batteries from the electronic speed control when the model is not in use and when it is being stored or transported.
- ⊕ Allow the battery packs to cool off between runs (before charging).
- ⊕ Do not use battery packs that have been damaged in any way.

- ⊕ Do not use battery packs that have damaged wiring, exposed wiring, or a damaged connector.
- ⊕ Children should have responsible adult supervision when charging and handling batteries.

SPEED CONTROL

- ⊕ **Disconnect the Batteries:** Always disconnect the batteries from the speed control when not in use.
- ⊕ **Transmitter on First:** Switch on your transmitter first before switching on the speed control to prevent runaways and erratic performance.
- ⊕ **Don't Get Burned:** The heat sink can get extremely hot, so be careful not to touch it until it is cool. Supply adequate airflow for cooling.
- ⊕ **Use Stock Connectors:** If you decide to change the battery or motor connectors, only change one battery or motor connector at a time. This will prevent damage from accidentally mis-wiring the speed control. Please note that modified speed controls can be subject to a rewiring fee when returned for service. Removing the battery connector on the speed control or using connectors with no reverse-polarity protection on the speed control will void the product's warranty.
- ⊕ **Insulate the Wires:** Always insulate exposed or damaged wiring with heat shrink tubing to prevent short circuits
- ⊕ **Always Use Heat Sinks:** Three heat sinks are factory-installed on the speed control and must be used for maximum cooling and performance.
- ⊕ **No Reverse Voltage:** The speed control is not protected against reverse polarity voltage. When changing the battery and/or motor, be sure to install the same type of connectors to avoid reverse polarity damage to the speed control. Removing the battery connectors on the speed control or using the same-gender connectors on the speed control will void the product's warranty.
- ⊕ **Do Not Let the Transistor Tabs Touch:** Never allow the three separate transistor banks to touch each other or any exposed metal. This will create a short circuit and damage the speed control. (For example, laying a metal tool across the heat sinks can damage the speed control.)
- ⊕ **No Schottky Diodes:** External Schottky diodes are not compatible with reversing speed controls. Using a Schottky diode with the EVX-2 will damage the ESC and void the 30-day warranty.

TOOLS, SUPPLIES AND REQUIRED EQUIPMENT

Your model comes with a set of specialty metric tools. You'll need to purchase other items, available from your hobby dealer, to operate and maintain your model.

SUPPLIED TOOLS AND EQUIPMENT



2.0mm "T" wrench



1.5mm "L" wrench



2.5mm "L" wrench

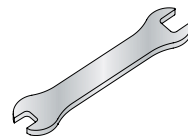

8mm/5mm wrench

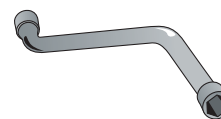

Universal wrench

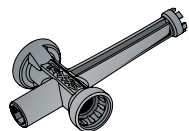

Suspension multi-tool



Antenna nut wrench



Pre-load spacers and shock pistons
(on parts tree) *see page 20*



Body clips



Foam blocks (battery spacers)
see page 12

REQUIRED TOOLS AND EQUIPMENT (SOLD SEPARATELY)



8 AA alkaline
batteries

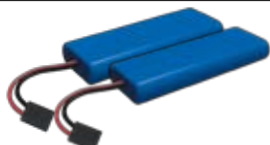

Two NiMH battery packs (7.2V 6-cell
or 8.4-volt 7-cell [recommended])



NiMH battery charger
(peak detecting type recommended - *see sidebar*)

Warning: Lithium Polymer (LiPo) batteries should not be used with the EVX-2. The EVX-2 electronic speed control is not equipped with low-voltage detection.



For more information on batteries, see *Use the Right Batteries* on page 10.



A peak-detecting charger is recommended for best performance and longest battery life. For more information, see *Use the Right Charger* on page 12.



Recommended Equipment

These items are not required for the operation of your model, but are a good idea to include in any R/C toolbox:

- Safety glasses
- Thin, hobby-quality cyanoacrylate instant tire glue (CA glue)
- Hobby knife
- Side cutters and/or needle nose pliers
- Phillips screwdriver
- Soldering iron

ANATOMY OF THE E-MAXX

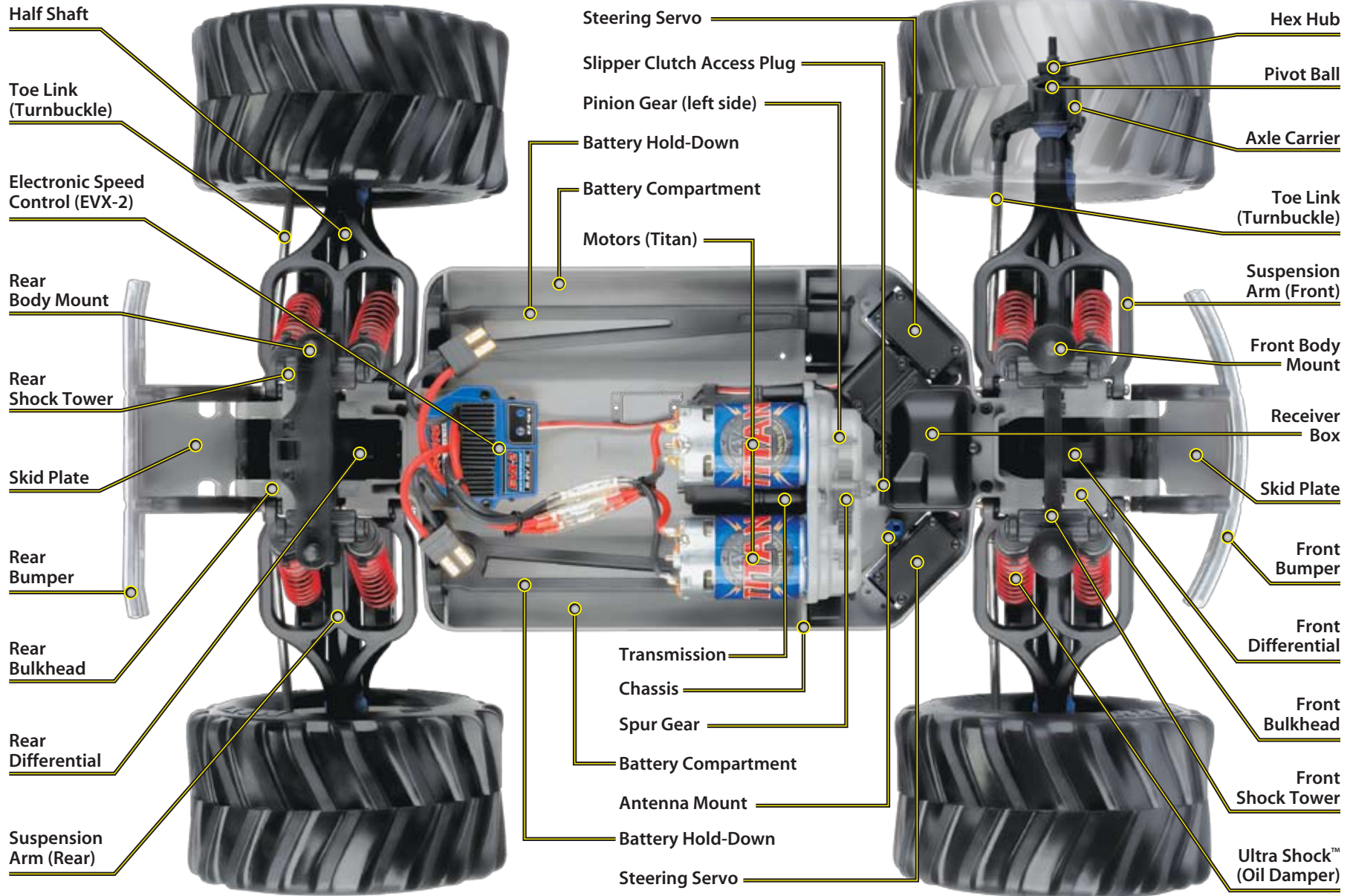

QUICK START: GETTING UP TO SPEED

The following guide is an overview of the procedures for getting your model running. Look for the Quick Start logo on the bottom corners of Quick Start pages.

1. Read the safety precautions on page 4

For your own safety, understand where carelessness and misuse could lead to personal injury.

9. Detail your model • See page 8

Apply other decals if desired.

2. Charge the battery packs • See sidebar, page 12

Fully charge two 7.2 or 8.4-volt battery packs (not included). Charge your batteries now so it will be ready when you finish the other setup procedures.

10. Drive your model • See page 17

Driving tips and adjustments for your model.

3. Install the antenna • See page 11

Install the antenna mast in the model.

11. Maintaining your model • See page 25

Follow these critical steps to maintain the performance of your model and keep it in excellent running condition.

4. Install batteries in the transmitter • See page 11

The transmitter requires 8 AA alkaline or rechargeable batteries.

5. Install battery packs in the model • See page 12

Your model requires two fully charged 7.2 or 8.4-volt battery packs (not included).

6. Turn on the radio system • See page 14

Make a habit of turning the transmitter on first, and off last.

7. Check servo operation • See page 14

Make sure the steering servos are working correctly.

8. Range test the radio system • See page 14

Follow this procedure to make sure your radio system works properly at a distance and that there is no interference from outside sources.



The Quick Start Guide is not intended to replace the full operating instructions available in this manual. Please read this entire manual for complete instructions on the proper use and maintenance of your model.

Look for the Quick Start logo at the bottom of Quick Start pages.



DECORATING YOUR MODEL

APPLYING THE DECALS

The main decals for your model have been applied at the factory. The decals are printed on self-adhesive clear mylar and are die-cut for easy removal. Use a hobby knife to lift the corner of a decal and lift it from the backing. To apply the decals, place one end down, hold the other end up, and gradually smooth the decal down with your finger as you go. This will prevent air bubbles. Placing both ends of the decal down and then trying to smooth it out will result in air pockets.

Look at the photos on the box for typical decal placement.

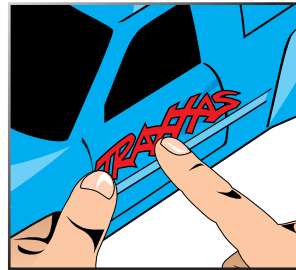

TIRE GLUING

The factory tires on your E-Maxx are already glued to the rims. The tires must be glued to the rims to prevent the rims from spinning inside the tires. The instructions here are provided to show you how to glue replacement tires to the rims in the future. Use CA tire glue available from your local hobby dealer. You can glue the tires without removing the wheels from the truck. For clarity, these instructions show the process with the wheels removed.

1. Remove a wheel from E-Maxx using the larger (8mm) end of the universal wrench.

2. Use your thumb to push the side of the tire away from the rim. Place one or two drops of CA glue into the opening and release the tire. Capillary action will draw the glue around the bead of the tire.

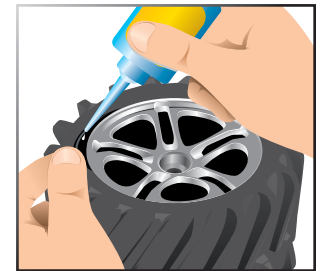

3. Repeat step two at four or five points around the rim, until the tire is completely secured to the rim. Turn the rim over and repeat the process for the inside of the rim/tire. Repeat for the other three wheels.

4. Reinstall the wheels, make sure none of the axle pins have fallen out from behind the hex hubs.



THE TRAXXAS TQ RADIO SYSTEM

Your model is equipped with the Traxxas TQ Radio System. The Traxxas TQ Radio System is a 2-channel system that provides high-power output up to a quarter mile. Model 3905 uses two steering servos and an electronic speed control. The receiver is equipped with four channels and dual channel 1 outputs for the steering servos.

TQ TRANSMITTER

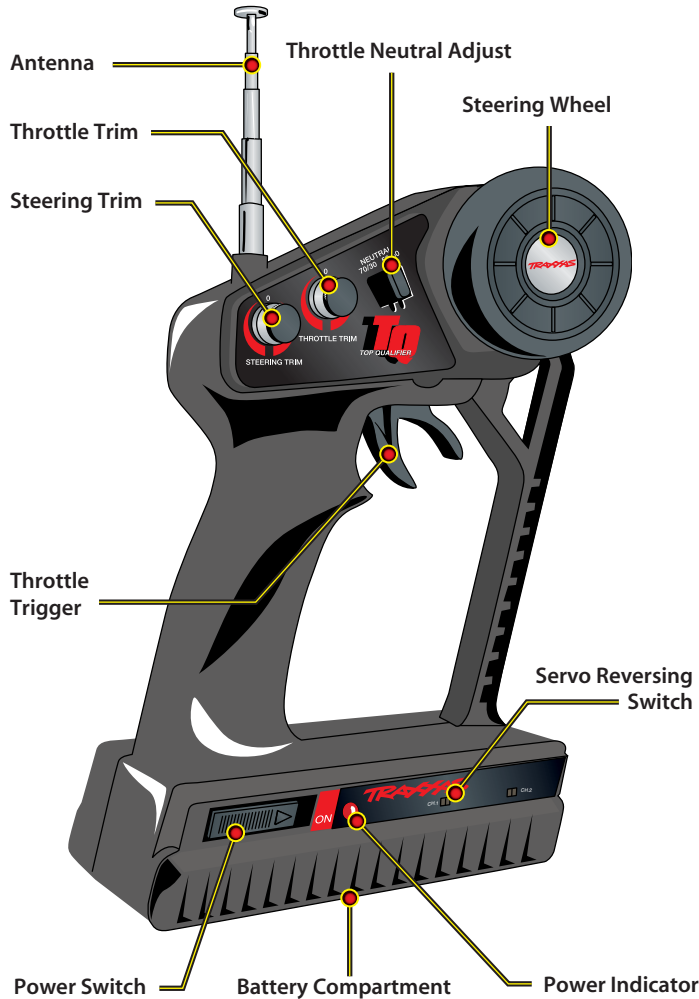

WIRING DIAGRAM

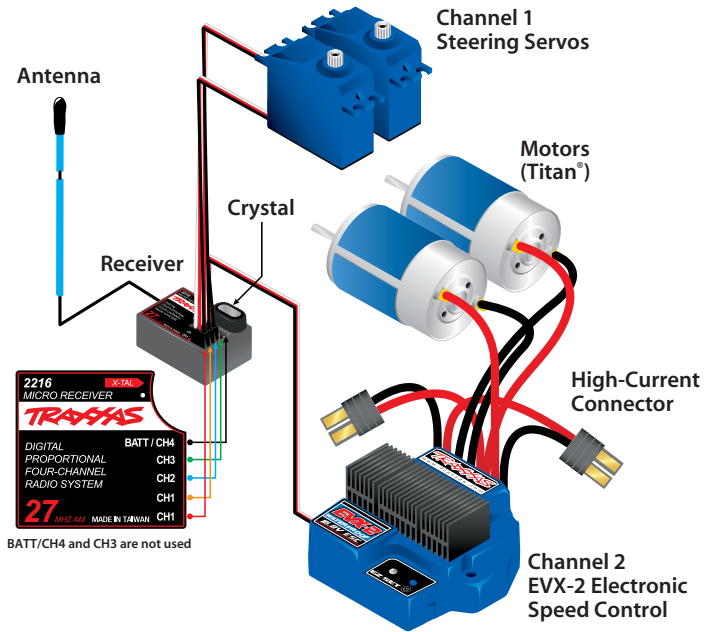

EVX-2 ELECTRONIC SPEED CONTROL

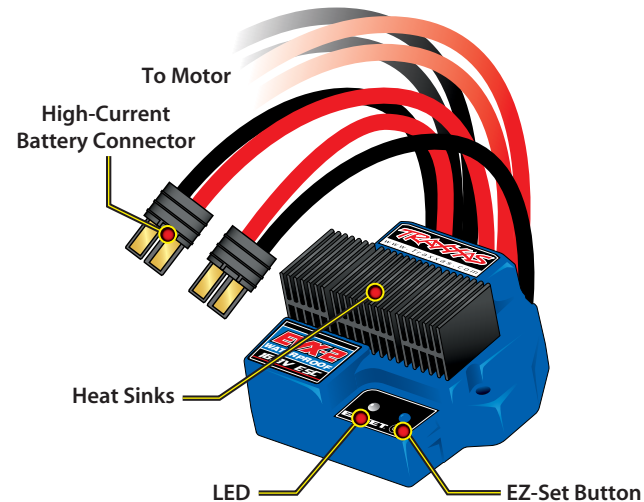

EVX-2 Wiring Diagram

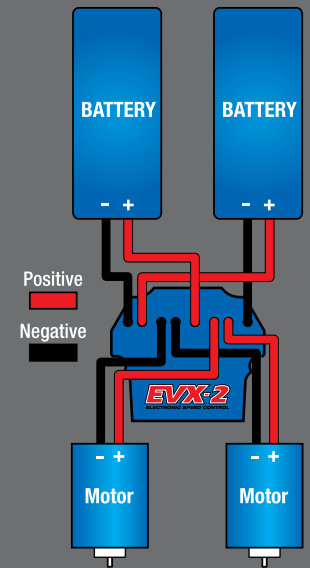



Use the Right Batteries

Your transmitter uses AA batteries. Use new alkaline batteries, or rechargeable batteries such as NiCad or NiMH (Nickel Metal Hydride) batteries in your transmitter. Make sure rechargeable batteries are fully charged according to the manufacturer's instructions.

If you use rechargeable batteries in your transmitter, be aware that when they begin to lose their charge, they lose power more quickly than regular alkaline batteries.







Caution: Discontinue running your model at the first sign of weak batteries (flashing red light) to avoid losing control.

RADIO SYSTEM TERMINOLOGY

Please take a moment to familiarize yourself with these radio-system terms. They will be used throughout this manual.

BEC (Battery Eliminator Circuit) - The BEC can either be in the receiver or in the ESC. This circuit allows the receiver and servos to be powered by the main battery pack in an electric model. This eliminates the need to carry a separate pack of 4 AA batteries to power the radio equipment.

Channel - The 27 MHz frequency band is divided into 6 channels so that up to six models can be operated simultaneously. Each channel is referred to by its flag color and channel number, as shown below.

CHANNEL	FREQUENCY BAND	FLAG COLOR	TRAXXAS PART NO.
 1	26.995	BROWN	2031
 2	27.045	RED	2032
 3	27.095	ORANGE	2033
 4	27.145	YELLOW	2034
 5	27.195	GREEN	2035
 6	27.255	BLUE	2036

Clearing your frequency - A routine, verbal check to make sure nobody else in your area is operating on the same channel. Always clear your frequency by calling out your channel number before operating your model. Wait or move to another area if your channel is already being used.

Crystal (X-tal) - The plug-in device that determines which channel the radio system will operate on. For each channel, there are two crystals, one for the receiver and one for the transmitter. Of those two crystals, the one marked with the lower number (.455 MHz lower) must be inserted into the receiver.

ESC (Electronic Speed Control) - An electronic speed control is the electronic motor control inside the model. The EVX-2 uses MOSFET power transistors to provide precise, digital proportional throttle control. Electronic speed controls use power more efficiently than mechanical speed controls so that the batteries run longer. An electronic speed control also has circuitry that prevents loss of steering and throttle control as the batteries lose their charge.

Frequency band - The radio frequency used by the transmitter to send signals to your model. All Traxxas RTR models operate on a 27 MHz frequency band.

mAh - Abbreviation for milliamp hour. A measure of the capacity of the battery pack. The higher the number, the longer the battery will last between recharges.

Neutral position - The standing position that the servos seek when the transmitter controls are at the neutral setting.

NiCad - Abbreviation for nickel-cadmium. The original rechargeable hobby pack, NiCad batteries have very high current handling, high capacity, and can last up to 1000 charging cycles. Good charging procedures are required to reduce the possibility of developing a "memory" effect and shortened run times.

NiMH - Abbreviation for nickel-metal hydride. Rechargeable NiMH batteries offer high current handling, and much greater resistance to the "memory" effect. NiMH batteries generally allow higher capacity than NiCad batteries. They can last up to 500 charge cycles. A peak charger designed for NiMH batteries is required for optimal performance.

Receiver - The radio unit inside your model that receives signals from the transmitter and relays them to the servos.

Servo - Small motor unit in your model that operates the steering mechanism.

Transmitter - The hand-held radio unit that sends throttle and steering instructions to your model.

Trim - The fine-tuning adjustment of the neutral position of the servos, made by adjusting the throttle and steering trim sliders on the face of the transmitter.

Thermal Shutdown Protection - Temperature sensing electronics are used in the ESC to detect overloading and overheating of the transistor circuitry. If excessive temperature is detected, the unit automatically shuts down to prevent damage to the electronics.

2-channel radio system - The TQ radio system, consisting of the receiver, the transmitter, and the servos. The system uses two channels: one to operate the throttle and one to operate the steering.

550 and 540 - These numbers refer to the size of the motor. 550 motors have armatures that are 30% longer than 540 motors.

INSTALLING TRANSMITTER BATTERIES

Your TQ transmitter uses 8 AA batteries (see sidebar, page 10). The battery compartment is located in the base of the transmitter.

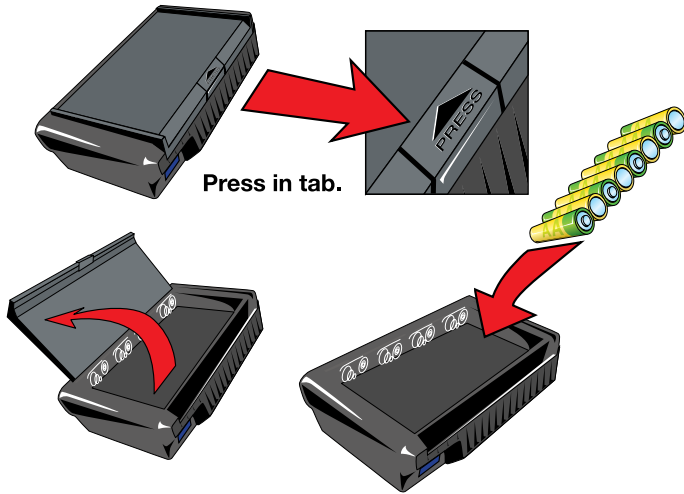

1. Remove the battery compartment door by pressing the tab and lifting the door up.
2. Install the batteries in the correct orientation as indicated in the battery compartment.
3. Reinstall the battery door and snap it closed.
4. Turn on the transmitter and check the power indicator for a solid red light.

If the power indicator light flashes, then the transmitter batteries are weak, discharged or possibly installed incorrectly. Replace with new or freshly charged batteries. The power indicator light does not indicate the charge level of the battery pack installed in the model.

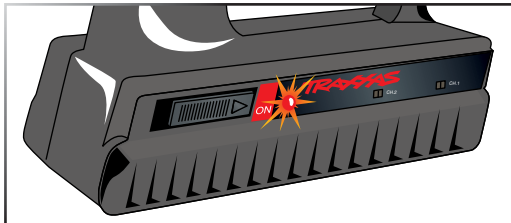

SETTING UP THE ANTENNA

1. Locate the black antenna wire that exits the receiver box.
2. Pull the wire straight with your fingers and then insert the end of the wire into one end of the antenna tube (the antenna tube, tip, crimp nut and sleeve are located in the documents bag). Push the wire all the way through the antenna tube.
3. Insert the base of the tube into the antenna post. Take care not to crimp the antenna wire.
4. Slide the crimp nut over the antenna tube and screw it onto the antenna post. Use the supplied tool to tighten the crimp nut on the post just until the antenna tube is securely in place. Do not over tighten or crush the antenna wire against the chassis.
5. Fold the top of the antenna wire over the top of the antenna tube. Slide the antenna sleeve over the tube to retain the antenna wire. Now slide the antenna tip onto the top of the antenna tube. Never cut or shorten the antenna wire.
6. On the transmitter, always fully extend the telescoping antenna when running your model. Make a habit of holding the transmitter so the antenna points straight up.

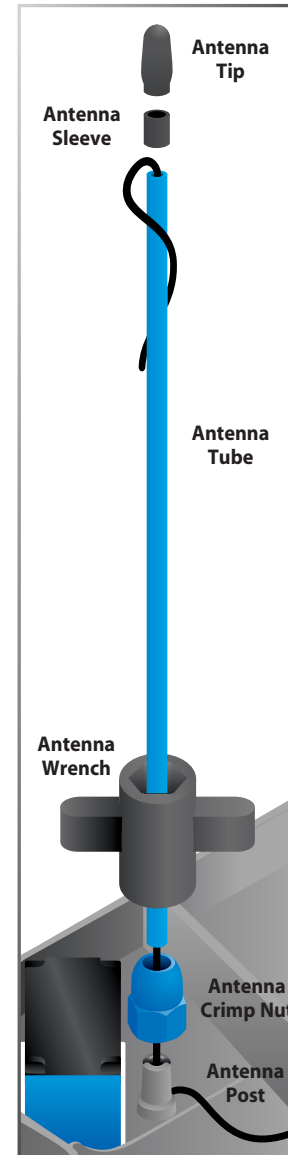

If the power indicator doesn't light red, check the polarity of the batteries. Check rechargeable batteries for a full charge.



Spray a little window cleaner on the antenna wire to make it easier to push through the antenna tube.



If there are any kinks in the black antenna wire, it will be more difficult to push through the antenna tube. Pull the wire straight by sandwiching it between your thumb and index finger and running your fingers along the length of the wire (with medium pressure).



Don't shorten the length of the antenna wire. Its length is tuned to the frequency band; cutting it could severely shorten the radio system's range.



See page 19 for more information about the receiver box and maintaining a watertight seal.





Use the Right Charger

The most convenient type of charger is an AC peak-detecting charger that plugs directly into an AC wall outlet. It contains special peak-detection circuitry that automatically shuts the charger off when the battery is fully charged.

If you're using a 15-minute timed charger, always fully discharge the battery pack before each charge. Some high mAh battery packs (1500 mAh or higher) require more than the standard 15 minutes of charge time. If the battery pack is cold after 15 minutes of charging, add another 5 minutes of charge time. Closely monitor the battery pack and stop charging it when it begins to feel warm to the touch. Never leave a battery charging unattended. Always follow charger manufacturer's instructions.

Warning: Lithium Polymer (LiPo) batteries should not be used with the EVX-2. The EVX-2 is not equipped with low-voltage detection.



INSTALLING BATTERY PACKS

The E-Maxx requires two fully charged 7.2 or 8.4-volt (stick style) NiMH battery packs. These batteries are not included with the model. For the best performance, use 7-cell battery packs. When using 6-cell battery packs, install the supplied foam block (spacer) into the front of the battery compartment. The spacers are located in your instructions package. The spacers are shaped to conform to the chassis. There is a right and a left. Test fit them to confirm their location. Remove the backing from the self adhesive strips and secure them to the front of the battery compartments.

Using Different Battery Configurations

The battery hold-downs are capable of accommodating either side-by-side racing style packs or the more common stick packs. The battery compartments are configured for stick packs from the factory. The number on each side of the hold down indicates the battery height in millimeters that hold-down can accommodate. Note that one side is labeled "25" and other side is labeled "23". The 25mm side is for use with typical stick type battery packs. If you are using side-by-side racing packs, simply flip the hold-down over to the 23mm side and use it on the opposite side of the chassis. Accessory hold downs and foam (part #3927X) are available to accommodate larger battery packs. See the 3905 E-Maxx parts list for more information.

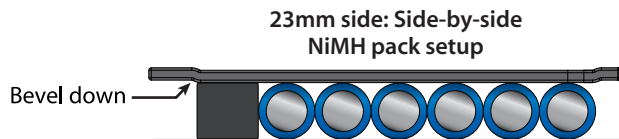
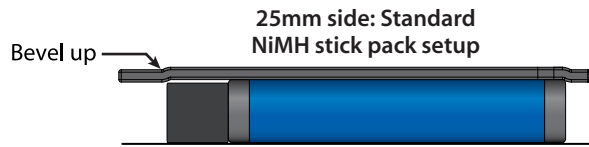
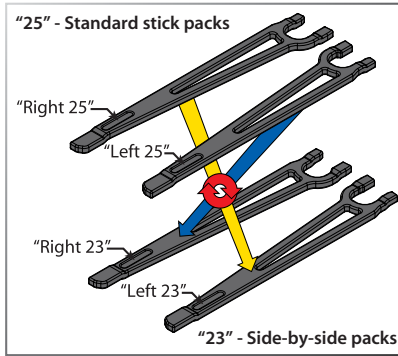

Battery Installation

1. Remove the battery hold-down by pressing on the release tab and lifting out the hold-down.
2. Install the battery pack with the battery wires facing the rear of the model. Your model includes foam blocks which should be installed behind 6-cell batteries for a more secure fit.
3. Insert the tabs of the battery hold-down into the slots in the rear hold-down retainer (A). Swing the battery hold-down towards the chassis and snap (lock) the end into the front hold-down retainer (B).

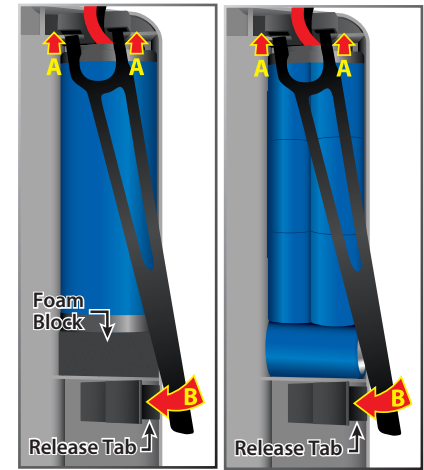

The Traxxas High Current Connector

Your model is equipped with the Traxxas High-Current Connector. Standard connectors restrict current flow and are not capable of delivering the power needed to maximize the output of the EVX-2. The Traxxas connector's gold-plated terminals with a large contact surfaces ensure positive current flow with the least amount of resistance. Secure, long-lasting, and easy to grip, the Traxxas connector is engineered to extract all the power your battery has to give.



To run this model, your batteries must be equipped with Traxxas High-Current Connectors. Batteries can either be purchased new with Traxxas connectors installed or Traxxas connectors can be purchased to install on battery packs you already own. See sidebar on page 13 for packages available from your hobby dealer.

The typical Molex style connector is inadequate for use in your model. It creates resistance that becomes a bottleneck to current flow. **If your battery pack is equipped with a Molex connector, it must be replaced with a Traxxas High-Current Connector to mate with the EVX-2 electronic speed control.**



Molex connector

TQ RADIO SYSTEM CONTROLS



There are two settings available:
50/50: Allows equal travel for both acceleration and reverse.
70/30: Allows more throttle travel (70%) and less reverse travel (30%).

Note: If you change throttle travel, you will need to reprogram the electronic speed control.

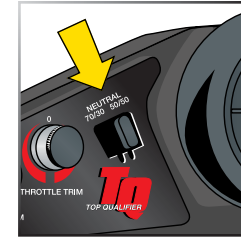

Electronic Throttle Trim

The electronic throttle trim located on the face of the transmitter adjusts the neutral (center) point of the electronic speed control. This control has been preset for you at the factory.

Electronic Steering Trim

The electronic steering trim located on the face of the transmitter adjusts the neutral (center) point of the steering servos when the servos are at rest. Adjust this control to make the model drive straight with no steering input at the wheel.

Servo Reversing Switches

The servo reversing switches are located on the front of the transmitter, next to the on/off switch. Moving a switch reverses the direction of the corresponding servo.

Each switch corresponds to a channel, as shown below. For example, if you turn the steering wheel to the right and your wheels turn left, you would move the Channel 1 switch to correct the servo direction. It may be necessary to adjust the corresponding trim control after moving a switch.

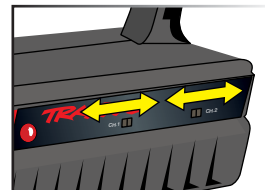

Channel	Servo
1	Steering
2	Throttle

Default Setting

TQ RADIO SYSTEM ADJUSTMENTS

In addition to the electronic throttle and steering trim controls, your radio system features throttle neutral adjustment and servo reversing switches. **These are preset at the factory and should not require further adjustment.**

Throttle Neutral Adjustment

The throttle neutral adjustment is located on the transmitter face and controls the forward/reverse travel of the throttle trigger. Change the adjustment by pressing the button and sliding it to the desired position.



Don't push the transmitter antenna down from the top. Pull it down from the bottom, one segment at a time, to prevent binding and kinking the antenna mast.



The following Traxxas High Current Connector packages are available from your hobby dealer. When using adapters, be careful not to exceed the current rating of the Molex connector.





Remember, always turn the TQ transmitter on first and off last to avoid damage to your model.



Your speed control was adjusted to the radio from the factory. It is possible for the throttle trim control on the transmitter to have moved during transit or while handling the transmitter. If the motors run when the model is switched on, then move the throttle trim control on the transmitter until the motors stop. If anything more than a slight adjustment of the throttle trim control is required, then you should readjust your speed control. Refer to the adjustments section on page 15.



When rechargeable batteries begin to lose their charge, they will fade much faster than alkaline dry cells. Stop immediately at the first sign of weak batteries. Never turn the transmitter off when the battery pack is plugged in. The model could run out of control.



TQ RADIO SYSTEM RULES

- ⊕ Each time you prepare to run your model, you must clear your frequency to be sure no one else in the area is using the same channel as you. There are six possible channels, numbered 1 through 6. Each is represented by a color. Look at the crystal plugged into the back of your transmitter to determine which channel your model is assigned to.
- ⊕ Always turn your TQ transmitter on first and off last. This procedure will help to prevent your model from receiving stray signals from another transmitter, or other source, and running out of control.
- ⊕ Always have the transmitter turned on before plug in the battery.
- ⊕ Always use new or freshly charged batteries for the radio system. Weak batteries will limit the range of the radio signal between the receiver and the transmitter. Loss of the radio signal can cause you to lose control of your model.

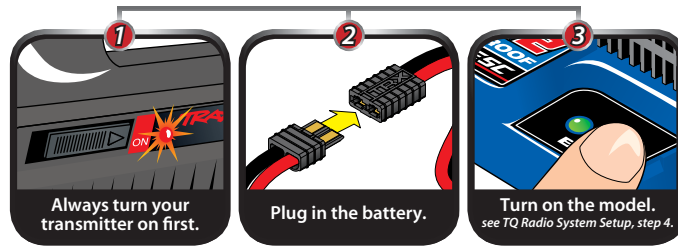

TQ RADIO SYSTEM SETUP

The TQ Radio System was pre-adjusted at the factory. The adjustment should be checked, before running the model, in case of movement during shipping. Here's how:

1. Fully extend the chrome antenna mast on the transmitter and turn the switch on. The red indicator light on the transmitter should be solid red (not flashing).
2. **Elevate the model so that all four tires are off the ground.** If you are holding the model, grip it firmly. Make sure your hands are clear of the moving parts of the model.
3. Plug the battery pack in the model into the speed control.

4. The on/off switch is integrated into the speed control. With the transmitter on, press the EVX-2 set button for 1/2 second, until the LED shines GREEN, then immediately release the button. This turns the model on (see page 15 for more on EVX-2 setup and operation). To turn the EVX-2 off, press the set button until the green LED turns off. **Always disconnect your batteries when the model is not in use.**
5. Turn the steering wheel on the transmitter back and forth and check for rapid operation of the steering servos. Also, check that the steering mechanism is not loose or binding. If the steering operates slowly, check for weak batteries.
6. When looking down at model, the front wheels should be pointing straight ahead. If the wheels are turned slightly to the left or right, slowly adjust the steering trim control on the transmitter until they are pointing straight ahead.
7. Operate the throttle trigger to ensure that you have full forward and reverse operation, and that the motors stop when the throttle trigger is at neutral.
8. Once adjustments are made, turn off your model, followed by the hand held transmitter.

RANGE-TESTING THE TQ RADIO SYSTEM

Before each running session with your model, you should range-test your radio system to ensure that it operates properly.

1. Turn on the radio system and check its operation as described in the previous section.
2. Have a friend hold the model. Make sure hands and clothing are clear of the wheels and other moving parts on the model.
3. Make sure your transmitter antenna is fully extended, and then walk away from the model with the transmitter until you reach the farthest distance you plan to operate the model.
4. Operate the controls on the transmitter once again to be sure that the model responds correctly.
5. Do not attempt to operate the model if there is any problem with the radio system or any external interference with your radio signal at your location.

ADJUSTING THE ELECTRONIC SPEED CONTROL

The EVX-2 electronic speed control is factory set and should not require any adjustments. These instructions are provided for your reference.

Transmitter Adjustments for the EVX-2 ESC

Before attempting to program your EVX-2, it is important to make sure your TQ transmitter is properly adjusted (set back to the factory defaults). Otherwise, you may not get the best performance from your speed control.

The transmitter should be adjusted as follows:

1. Set the throttle neutral switch to the 50/50 setting. This adjusts the transmitter's throttle trigger throw to 50% for throttle and 50% for braking and reverse.
2. Set the throttle trim control to the middle "0" setting.
3. Set the Channel 2 servo reversing switch to the left position. Do not change the position of any of the servo reversing switches after programming the EVX-2.
4. You are now ready to program your speed control.

Setup Programming (Calibrating your ESC and transmitter)

Read through all of the following programming steps before you begin. If you get lost during programming or receive unexpected results, simply unplug the battery, wait a few seconds, plug the battery back in, and start over.

1. Disconnect each of the motor wires between the EVX-2 and the motors. This is a precaution to prevent runaway when the speed control is turned on before it is programmed.
2. Connect two fully charged battery packs to the EVX-2.
3. Turn on the transmitter (with the throttle at neutral).
4. Press and hold the EZ-Set button (A). The LED will first turn green and then red. Release the EZ-Set button.
5. When the LED blinks RED ONCE. Pull the throttle trigger to the full throttle position and hold it there (B).



6. When the LED blinks RED TWICE. Push the throttle trigger to the full reverse and hold it there (C).



7. When the LED turns solid GREEN, programming is complete. The LED will continuously shine green indicating the EVX-2 is on and at neutral (D).

EVX-2 Operation

To operate the speed control and test the programming, place the vehicle on a stable block or stand so all of the driven wheels are off the ground. Reconnect the motor wires. Always make sure that objects and fingers are clear of the wheels.

1. With the transmitter on, press the EZ-Set button for 1/2 second, until the LED shines GREEN, then immediately release the button. This turns on the EVX-2. If you press and release too quickly, you may hear the steering servos jump but the LED may not stay on. (Note: If the throttle is not at neutral or if the throttle trim has been altered, the LED will turn off after one second and the wheels may begin to drive.)
2. Apply forward throttle. The LED will turn off until full throttle power is reached. At full throttle, the led will shine GREEN.
3. Move the trigger forward to apply the brakes. Note that braking control is fully proportional. The LED will turn off until full braking power is reached. At full brakes, the LED will shine GREEN.
4. Return the throttle trigger to neutral. The LED will shine GREEN.
5. Move the throttle trigger forward again to engage reverse (Profile #1). The LED will turn off. Once full reverse power is reached, the LED will shine GREEN.
6. To stop, return the throttle trigger to neutral. Note that there is no programmed delay when changing from reverse to forward. Use caution to avoid slamming the speed control from reverse to forward. On high-traction surfaces, this could result in transmission or driveline damage.
7. To turn the EVX-2 off, press the EZ-Set button until the green LED turns off.



EVX-2 Specifications

Input voltage:
6 to 14-cells
(7.2 to 16.8 volts DC)

Motor limit:
12-turns (550)

Continuous current:
30A

Peak current :
180A

BEC voltage:
6.0V DC

Transistor type:
MOSFET

Motor/Battery Wiring:
14-gauge

Protection:
Thermal shutdown

EVX-2 Wiring Diagram

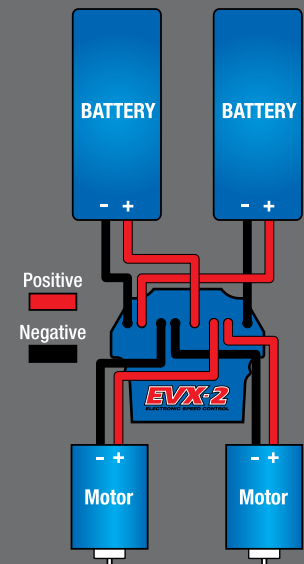



Patent Pending Training Mode (Profile #3) reduces forward and reverse throttle by 50%. Training Mode is provided to reduce the power output allowing beginning drivers to better control the model. As driving skills improve, simply change to Sport or Race Mode for full-power operation.



Tip For Fast Mode Changes
The EVX-2 is set to Profile 1 (Sport Mode) as the default. To quickly change to Profile 3 (Training Mode), with the transmitter on, press and hold the SET button until the light blinks red three times and then release. For full power, quickly change back to Profile 1 (Sport Mode) by pressing and holding the SET button until the light blinks red one time and then releasing.

Thermal Shutdown Protection

The EVX-2 is equipped with thermal shutdown protection to guard against overheating caused by excessive current flow. If the operating temperature exceeds safe limits, the EVX-2 will automatically shut down and the EVX-2 LED will flash red. The LED on the face of the EVX-2 will continuously flash red, even if the throttle trigger is moved back and forth. After the speed control cools down to a safe level, the LED will continuously shine green. The EVX-2 will once again function normally.

EVX-2 Profile Selection

The speed control is factory set to Profile #1. To change the profile, follow the steps on described below. The speed control should be connected to the receiver and battery, and the transmitter should be adjusted as described previously. The profiles are selected by entering the programming mode.

EVX-2 Profile Description

Profile #1 (Sport Mode): 100% Forward, 100% Brakes, 100% Reverse
Profile #2 (Race Mode): 100% Forward, 100% Brakes, No Reverse
Profile #3 (Training Mode): 50% Forward, 100% Brakes, 50% Reverse

Selecting Sport Mode (Profile #1)

1. Connect two fully charged battery packs to the EVX-2 and turn on your transmitter.
2. With the EVX-2 off, press and hold the EZ-Set button until the light turns solid green, then solid red and then begins blinking red (indicating the Profile numbers).
3. When the light blinks red once, release the EZ-Set button.
4. The light will then turn green and the model is ready to drive.

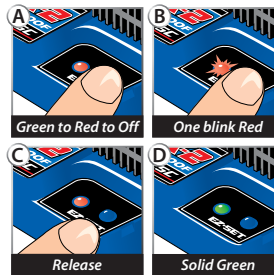

Selecting Race Mode (Profile #2)

1. Connect two fully charged battery packs to the EVX-2 and turn on your transmitter.
2. With the EVX-2 off, press and hold the EZ-Set button until the light turns solid green, then solid red and then begins blinking red (indicating the Profile numbers).
3. When the light blinks red twice, release the EZ-Set button.
4. The light will then turn green and the model is ready to drive.

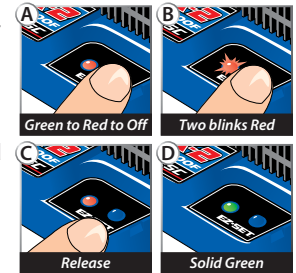

Selecting Training Mode* (Profile #3)

1. Connect two fully charged battery packs to the EVX-2 and turn on your transmitter.
2. With the EVX-2 off, press and hold the EZ-Set button until the light turns solid green, then solid red and then begins blinking red (indicating the Profile numbers).
3. When the light blinks red three times, release the EZ-Set button.
4. The light will then turn green and the model is ready to drive.

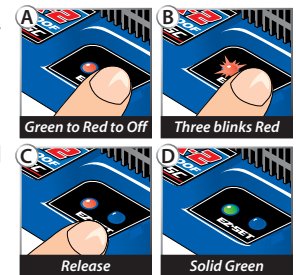

Note: If you missed the mode you wanted, keep the EZ-Set button pressed down and the blink cycle will repeat until a Mode is selected.

Now it's time to have some fun! This section contains instructions on driving and making adjustments to your model. Before you go on, here are some important precautions to keep in mind.

- ⚠ Allow the model to cool for a few minutes between runs. This is particularly important when using high capacity battery packs that allow extended periods of running. Monitoring temperatures will extend the lives of the batteries and motors..
- ⚠ Do not continue to operate the model with low batteries or you could lose control of it. Indications of low battery power include slow operation and sluggish servos (slow to return to center). Stop immediately at the first sign of weak batteries. When the batteries in the transmitter become weak, the red power light will begin to flash. Stop immediately and install new batteries.
- ⚠ Do not drive the model at night, on public streets, or in large crowds of people.
- ⚠ If the model becomes stuck against an object, do not continue to run the motors. Remove the obstruction before continuing. Do not push or pull objects with the model.
- ⚠ Because the model is controlled by radio, it is subject to radio interference from many sources beyond your control. Since radio interference can cause momentary losses of control, allow a safety margin of space in all directions around the model in order to prevent collisions.
- ⚠ Use good, common sense whenever you are driving your model. Intentionally driving in an abusive and rough manner will only result in poor performance and broken parts. Take care of your model so that you can enjoy it for a long time to come.
- ⚠ High performance vehicles produce small vibrations which may loosen hardware over time. Frequently check wheel nuts and other screws on your vehicle to ensure that all hardware remains properly tightened.

About Run Time

A large factor affecting run time is the type and condition of your batteries. The milliamp hour (mAh) rating of the batteries determines how large their "fuel tank" is. A 3000 mAh battery pack will theoretically run twice as long as a 1500 mAh sport pack. Because of the wide variation in the types of batteries that are available and the methods with which they can be charged, it's impossible to give exact run times for the model.

Another major factor which affects run time is how the model is driven. Run times may decrease when the model is driven repetitively from a stop to top-speed and with repetitive hard acceleration.

Tips for Increasing Run Time

- ⚠ Use batteries with the highest mAh rating you can purchase.
- ⚠ Use a high-quality peak-detecting charger.
- ⚠ Read and follow all maintenance and care instructions provided by the manufacturer of your batteries and charger.
- ⚠ Keep the EVX-2 cool. Get plenty of airflow across the ESC heat sinks.
- ⚠ Lower your gear ratio. Installing smaller pinion gears will lower your gear ratio and cause less power draw from the motors and batteries, and reduce overall operating temperatures. Always replace both pinion gears together.
- ⚠ Vary your speed. Continuous high-speed, high-gear running shortens the run time on the E-Maxx.
- ⚠ Maintain your model. Do not allow dirt or damaged parts to cause binding in the drivetrain. Keep the motors clean.

mAh Ratings and Power Output

The mAh rating of the battery can effect your top speed performance. The higher capacity battery packs experience less voltage drop under heavy load than low mAh rated packs. The higher voltage potential allows increased speed until the battery begins to become discharged.

RUNNING IN WET CONDITIONS

Your new Traxxas E-Maxx is designed with water-resistant features to protect the electronics in the model (receiver, servos, electronic speed control). This gives you the freedom to have fun driving your E-Maxx through puddles, wet grass, snow, and through other wet conditions. Though highly water resistant, the E-Maxx should not be treated as though it is submersible or totally, 100% waterproof. Water resistance applies only to the installed electronic components. Running in wet conditions requires additional care and maintenance for the mechanical and electrical components to prevent corrosion of metal parts and maintain their proper function.

Precautions

- ⚠ **Without proper care, some parts of your model can be seriously damaged due to contact with water. Know that additional maintenance procedures will be required after running in wet**



conditions in order to maintain the performance of your model. Do not run your model in wet conditions if you are not willing to accept the additional care and maintenance responsibilities.

- ☞ Not all batteries can be used in wet environments. Consult your battery manufacturer to see if their batteries can be used in wet conditions. Do not use LiPo batteries in wet conditions (note: the EVX-2 is not LiPo compatible).
- ☞ The Traxxas TQ transmitter is not water resistant. Do not subject it to wet conditions such as rain.
- ☞ Do not operate your model during a rain storm or other inclement weather where lightning may be present.
- ☞ Do NOT allow your model to come in contact with salt water (ocean water), brackish water (between fresh water and ocean water), or other contaminated water. Salt water is highly conductive and highly corrosive. Use caution if you plan to run your model on or near a beach.
- ☞ Even casual water contact can reduce the life of your motors. Special care must be taken to modify your gearing and/or your driving style in wet conditions to extend the life of the motors (details below).

Before Running Your Vehicle in Wet Conditions

1. Consult the section "After Running Your Vehicle in Wet Conditions" before proceeding. Make sure you understand the additional maintenance required with wet running.
2. The wheels have small holes molded in to allow air to enter and exit the tire during normal running. Water will enter these holes and get trapped inside the tires if holes are not cut in the tires. Cut two small holes (4mm or 3/16" diameter) in each tire. Each hole should be near the tire centerline, 180 degrees apart.
3. Confirm that the RX box O-ring and cover are installed correctly and secure. Make sure the screws are tight and the blue O-ring is not visible protruding from the edge of the cover.
4. Confirm that your batteries can be used in wet conditions.
5. Use lower gearing (smaller pinion gears, as low as 12T) when running in mud, deep puddles, snow, or other similar situations that will restrict the tires and put much higher loads on the motors.

Motor Precautions

- ☞ Titan motor life can be greatly reduced in mud and water. If the motors get excessively wet or submerged, use very light throttle (run the motors slowly) until the excess water can run out. Applying full throttle to a motor full of water can cause rapid motor failure. Your driving habits will determine motor life with wet motors. Do not submerge the motors under water.
- ☞ Do not gear the motors by temperature when running in wet conditions. The motors will be cooled by water contact and will not give an accurate indication of appropriate gearing.

After Running Your Vehicle in Wet Conditions

1. Drain the tires by spinning the tires at full throttle to "sling" the water out. An easy way to do this is to remove the body and set the truck upside down on a flat surface. Apply full throttle so the tires spin and throw the excess water out of the holes you cut into the tires.
2. Remove the batteries.
3. Rinse excess dirt and mud off the truck with low-pressure water, such as from a garden hose. Do NOT use pressure washer or other high-pressure water. Avoid directing water into the bearings, transmission, differentials, etc.
4. Blow off the truck with compressed air (optional, but recommended). Wear safety glasses when using compressed air.
5. Remove the wheels from the truck
6. Spray all the bearings, drivetrain, and fasteners with WD-40® or similar water displacing light oil
7. Let the truck stand or you may blow off with compressed air. Placing the truck in a warm sunny spot will aid drying. Trapped water and oil will continue to drip from the truck for a few hours. Place it on a towel or piece of cardboard to protect the surface underneath.
8. As a precautionary step, remove the sealed receiver box cover. While unlikely, humidity or tiny amounts of moisture or condensation may enter the receiver box during wet running. This can cause long-term problems with the sensitive electronics in the receiver. Removing the receiver box cover during storage allows the air inside to dry. This step can improve the long-term reliability of the receiver. It is not necessary to remove the receiver or unplug any of the wires.

9. **Additional Maintenance:** Increase your frequency of disassembly, inspection and lubrication of the following items: This is necessary after extended wet use or if the vehicle will not be used for an extended period of time (such as a week or longer). This additional maintenance is needed to prevent any trapped moisture from corroding internal steel components.

- **Stub axle housing bearings:** Remove, clean, and re-oil the bearings.
- **Front and rear differential:** Remove, disassemble, clean, and re-grease the differentials. Refer to your exploded view diagrams for help with disassembly and reassembly.
- **Transmission:** Remove, disassemble, clean, and re-grease the transmission components. Use a light coating of wheel bearing grease (from an auto parts store) on the metal gear teeth. No grease is required for the nylon gears. Refer to your exploded view diagrams for help with disassembly and reassembly.
- **Titan motors:** Remove the motors, clean with aerosol motor cleaner, and re-oil the bushings with lightweight motor oil. Be sure to wear eye protection when using spray aerosol cleaners.



Receiver Installation

1. Always install the wires into the RX box before installing the receiver.
2. Install the antenna wire and the servo cables into the receiver box.
3. Arrange the wires neatly using the wire guides in the receiver box. The excess wire will be bundled inside the receiver box. Label which wire is for which channel.
4. Apply small bead of silicone grease (Traxxas part #1647) to the wire clamp.
5. Install the wire clamp and tighten the two 2.8x8mm cap screws securely.
6. Install the receiver into the box and plug the wires into receiver. Refer to page 9 for the wiring diagram.
7. Make sure the O-ring is properly seated into the groove in the receiver box so that the cover will not pinch it or damage it any way.
8. Install the cover and tighten the two 3x10mm button-head cap screws securely.
9. Inspect the cover to make sure that the O-ring seal is not visible.



RECEIVER BOX: MAINTAINING A WATERTIGHT SEAL

Removing and Installing Radio Gear

The unique design of the receiver box allows the removal and installation of the receiver without losing the ability to maintain a watertight seal in the box. The patent-pending wire clamp feature gives you the ability to also install aftermarket radio systems and maintain the watertight features of the receiver box.

Removing the Receiver

1. To remove the cover, remove the two 3x10mm button-head cap screws.
2. To remove the receiver from the box simply lift it out and set to the side. The antenna wire is still inside the clamp area and cannot be removed yet.
3. Remove the wire clamp by removing the two 2.8x8mm cap screws.
4. Unplug the servo cables from the receiver and remove the receiver.

TUNING ADJUSTMENTS



For easier access to the rear-most shock mounting screw, remove the one end of the rear turnbuckle. In the front, remove the suspension pin from the lower front suspension arm to gain easier access to the lower shock mounting screws.

SUSPENSION TUNING

Adjusting the Pivot Ball Caps

The pivot ball caps should be adjusted so that the pivot balls operate freely in the axle carriers with no excess play. Use the provided four-way suspension multi-tool to tighten or loosen the pivot ball cap.



Caster Adjustment

The E-Maxx offers the ability to adjust the caster angle of the front suspension. Caster adjustment may be used to influence the understeer/oversteer handling characteristics of the E-Maxx. Increasing the caster angle will increase the tendency of the truck to oversteer (less traction on the rear tires, more traction on the front tires), while decreasing the caster angle will cause the truck to have a tendency to understeer (push in the turns). This effect becomes more pronounced at higher steering angles and higher spring rates. Caster is adjusted by repositioning the shims on the pivot point of the upper suspension arms.

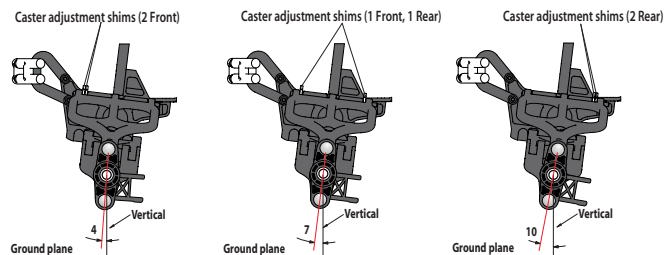

The stock caster setting is 7-degrees with one shim at each end of the arm. Reduce the caster angle to 4-degrees by removing the rear shim and inserting it next to the front shim. The caster angle can be increased to 10-degrees by removing the front shim and inserting it next to the rear shim.

Fine Tuning the Shocks

The eight shocks (oil dampers) on your E-Maxx have tremendous influence on its handling. Whenever you rebuild your shocks, or make any changes to the pistons, springs or oil, always do it carefully and in sets (front or rear). Piston head selection depends on the range of oil viscosities that you have available. For example, using a two-hole piston with lightweight oil will give you the same damping as a three-hole piston with heavier oil.

We recommend using two-hole pistons with a range of oil viscosities from 30W to 50W (available from your hobby shop). The thinner viscosity oils (30W or less) flow with less resistance and provide less damping, while thicker oils provide more damping. Use only 100% pure silicone shock oil to prolong seal life. From the factory, the E-Maxx uses 30W oil.

The ride height for the E-Maxx can be adjusted by adding or removing the clip-on spring pre-load spacers. Note that changes in ride height will occur when changes in shock angle or spring rates are made. You can compensate for ride height changes by changing the pre-load spacers on the shocks.

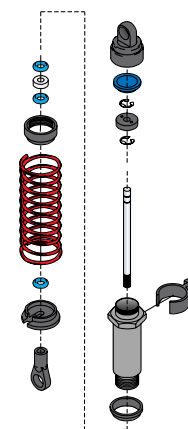

Shock Mounting Positions

Big bumps and rough terrain require a softer suspension with the maximum possible suspension travel and ride height. Racing on a prepared track or on-road use requires a lower ride height and firmer, more progressive suspension settings. The more progressive suspension settings help reduce body roll (increased roll stiffness), dive during braking, and squat during acceleration.

Upper shock mounting position (A) should generally be used with lower shock mounting positions 1 and 2. Upper shock mounting position (B) should generally be used with lower shock mounting positions 3 and 4. The innermost upper shock mounting position (0) can be used for tuning with the inner pair of lower shock mounting positions on the arm (1,2). It is not compatible with lower shock mounting positions 3 and 4. Other combinations may be used to achieve individualized suspension settings.

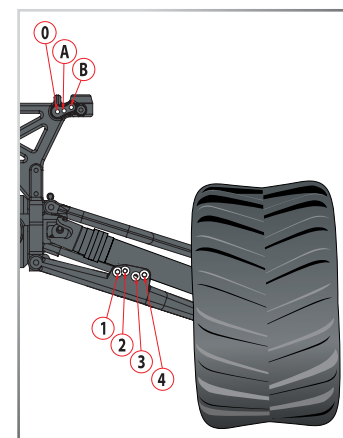

Lower Shock Mounting Positions

In the out-of-the-box configuration, the shocks are installed in position (A) on the shock tower and position (2) on the lower suspension arm. This setting allows for firm suspension and low ride height, increasing the spring force (at the wheel). This setting improves high-speed cornering on smoother terrain by lowering the center of gravity. Body roll, brake dive, and squat are also reduced.

The inner pair of holes on the lower suspension arm should be used to increase the ride height of the E-Maxx. The more vertical position of the shocks will allow for lower shock progression and the soft, plush feel that's characteristic of a Traxxas Maxx Truck.

Spring rate (at the wheel) increases as the lower shock mounting position is moved from position (1) to position (4). This is equivalent to using stiffer springs. Use higher spring rate settings for flatter terrain with smaller and fewer bumps, and lower spring rate settings for bigger bumps.

Ride height decreases as the lower shock mounting position is

moved from position (1) to position (4). Each pair of lower shock mounting holes (1,2 and 3,4) has equal ride height. Use lower ride height for high-speed cornering and flat terrain, and when racing on relatively smooth tracks. Increase the ride height for rougher terrain and tracks.

Upper Shock Mounting Positions

The upper shock mounting positions will have suspension effects opposite from the lower shock mounting positions.

Spring rate (at the wheel), increases as the upper shock mounting position is moved from position (A) to position (B).

Ride height is not affected by changes in the upper shock mounting position.

Use the chart below to see the effect of the various shock mounting positions. The horizontal length of the lines indicates the amount of suspension travel. The angle or slope of the lines indicates the spring rate (at the wheel).

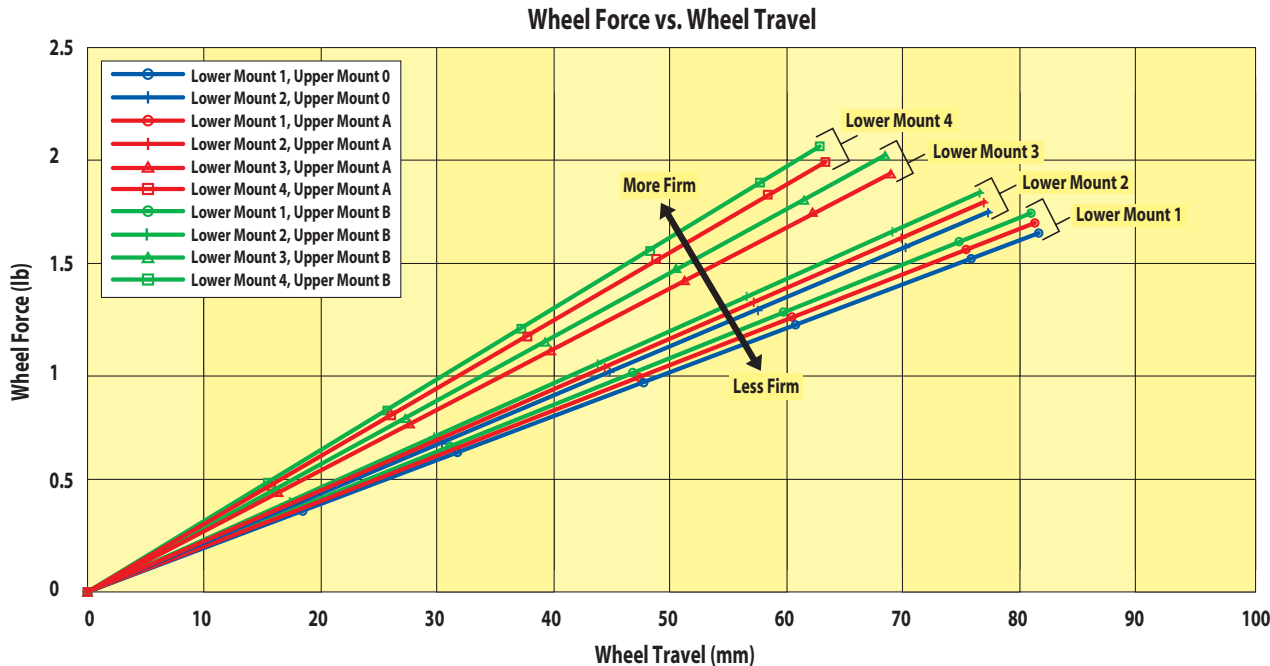



To achieve a good starting point for the slipper clutch, tighten the slipper clutch adjusting nut clockwise until the slipper clutch adjusting spring fully collapses (do not over tighten), and then turn the slipper clutch nut counter-clockwise ¼ to ½ turn.

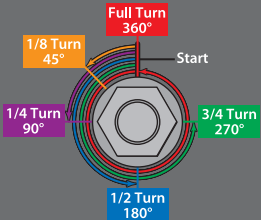

All of the toe links are installed on the truck so that the left hand thread indicators point to the same direction. This makes it easier to remember which way to turn the wrench to increase or decrease toe link length (the direction is same at all four corners). Note that the groove in the hex indicates the side of the toe link with the left-hand threads.

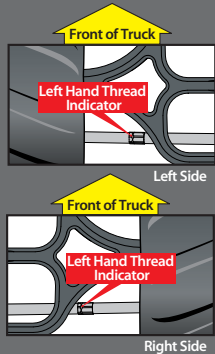

ALIGNMENT SETTINGS

Adjusting the Toe-in

Your E-Maxx comes from the factory with zero degrees of toe-in in the front, and one degree of toe-in in the rear. You can adjust the toe-in on the front and rear of the truck. Set the steering trim on your transmitter to neutral. Next, adjust your steering turnbuckles so that both front wheels are pointing straight ahead and are parallel to each other (0 degrees toe-in). This will ensure the same amount of steering in both directions. Adjust the rear toe control links so that the rear wheels have 1° of toe-in.

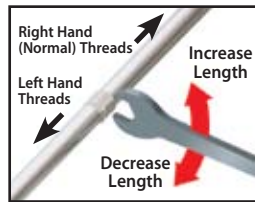
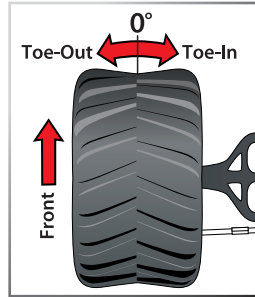

Static Camber Adjustment

The wheels can be set to have either positive or negative camber (see illustration below). The camber angle changes as the wheel moves up and down through its range of travel. Static camber is the camber angle at the wheel when the vehicle is set at its normal, stationary ride height.

The suspension pivot balls located in the axle carriers adjust the static camber. The pivot balls are protected by blue dust plugs. To adjust your static camber, insert the supplied 2.5mm hex wrench through the slit in the dust plug and engage the end of the pivot ball (compressing the suspension until the arms are parallel to the ground will allow for easier hex wrench engagement). The upper pivot ball is normally screwed all the way in. Negative camber is achieved by screwing the pivot ball of the lower control arm out. **Note:** When camber is changed, the toe angle of the wheel has to be reset.

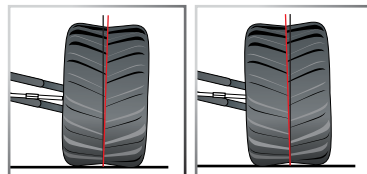

Positive Camber Negative Camber

Static Camber Base Factory Settings

Front: 1-degree negative camber each side
Rear: 1-degree negative camber each side

TRANSMISSION TUNING

Adjusting the Slipper Clutch

The E-Maxx is equipped with an adjustable Torque Control slipper clutch which is built into the large spur gear. The purpose of the slipper clutch is to regulate the amount of power sent to the rear wheels to prevent tire spin. When it slips, the slipper clutch makes a high-pitch, whining noise.

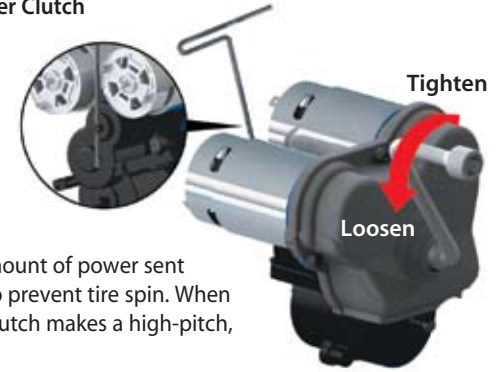

To adjust the slipper clutch, remove the rubber slipper clutch plug on the transmission cover. The slipper clutch is integrated into the main spur gear on the transmission. The slipper clutch is adjusted using the spring-loaded locknut on the slipper shaft. Use the supplied universal wrench. To tighten or loosen the slipper nut, insert the 2.0mm hex wrench into the hole in the end of the slipper shaft. This locks the shaft for adjustments. Turn the adjustment nut clockwise to tighten (less slippage) and counter-clockwise to loosen (more slippage).

WHEELS AND TIRES

Many types of aftermarket tires and wheels can be adapted for use on your model. Most will affect the overall width and the suspension geometry of the model. The offsets and dimensions designed into the model's wheels are intentional; therefore, Traxxas cannot recommend the use of other non-Traxxas wheels with different specifications. The diameter of the wheels is an innovative design, and there is a variety of different tires available for you to experiment with in addition to the included tires on the model (listed in your parts list). Experimentation with different types of tires is recommended to see which ones work the best on the terrain where the model is run. When selecting tires, consider the overall diameter and the rubber compound (hard or soft). If the overall diameter of the tire is significantly increased, you will need to use a smaller pinion gear to compensate for the larger tire. Soft compound tires with many short spikes generally work better on hard, dry surfaces. In loose dirt, a tire with large spikes should perform better. See your parts list for accessory wheels and tires.

MOTORS AND GEARING

The Titan™ 550 Motors on your E-Maxx have been carefully designed to match the needs of the E-Maxx. The Titans are made to run efficiently at high voltage to provide more torque and longer run times. We do not recommend converting the E-Maxx to a typical low voltage setup using traditional 540 size motors. While these components will physically fit into the E-Maxx, the system will not run as efficiently, losing power in the form of motor and battery heating. The result will be shorter run times, high current draw, and extreme battery and motor temperatures. If you are considering replacement motors, look for 550 motors capable of 12 or more volts.

The E-Maxx is equipped from the factory with a 68-tooth spur gear and 19-tooth pinion gears. E-Maxx has a large range of gearing making it suitable for many different types of applications and environments. If you want more acceleration and less top speed, use a smaller pinion gear (fewer teeth, higher numerical ratio). The overall reduction is the number of turns the motor makes for one revolution of the tire. Higher numerical ratios provide more torque, lower numerical ratios provide more top speed. **With the Titan motors, do not use a pinion gear larger than 20-tooth with the stock 68-tooth spur gear with 6-cell battery packs or a pinion gear larger than 19-tooth with the stock 68-tooth spur gear when using 7-cell battery packs.** Use the following formula to calculate the overall ratio for combinations not listed on the gear chart:

$$\frac{\text{\# Spur Gear Teeth}}{\text{\# Pinion Gear Teeth}} \times 5.22 = \text{Final Gear Ratio}$$

Going Brushless

Brushless motors provide increased power output and greater efficiency. The E-Maxx is designed with extra transmission and driveline strength to make it capable of handling extreme brushless power. One or two brushless motors may be used. A specially designed motor plate (part # 3997X) and gear cover (part # 3977X) are available for optimized, single-motor installations. If you plan to run LiPo battery packs to power a LiPo-compatible brushless system, optional battery hold downs (part # 3927X) are available to accommodate larger, high capacity 2S and 3S LiPo battery packs.

For the ultimate in extreme brushless speed and acceleration, install twin Velineon power systems (part number 3350). Two Velineon brushless motors powered by two Velineon VXL-3s speed controls in tandem results in amazing power output. Visit www.Traxxas.com for more details about power upgrades.

Adjusting Gear Mesh

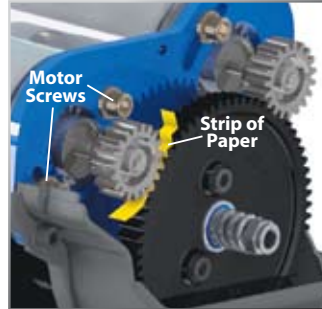

Incorrect gear mesh is the most common cause of stripped spur gears. Gear mesh should be checked and adjusted anytime a gear is replaced. Access the gears by removing the single screw on the top gear cover.

To set the gear mesh, cut a narrow strip of notebook paper and run it into the gear mesh. Loosen the motor screws and slide a motor and pinion gear into the spur gear. Retighten the motor screws and then remove the strip of paper. Repeat with the other motor. You should be able to run a fresh strip of paper through the gears without binding them.

DUAL STEERING SYSTEM

Your new E-Maxx uses dual-servo steering and a single heavy-duty servo saver for powerful, responsive steering. To prevent damage to the steering servos, it is important to make sure that the servos are "at rest" when the steering is at neutral. If one servo is out of adjustment, then both servos will work against each other, fighting to find center.

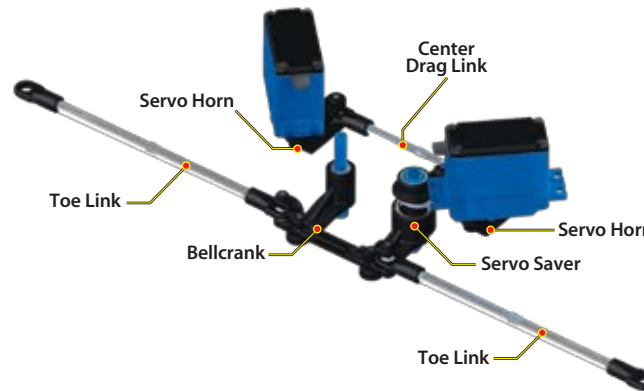

Gearing Compatibility Chart:

The chart below shows a full range of gear combinations. This does NOT imply that these gear combinations should be used. Over-gearing (bigger pinions, smaller spurs) can overheat and damage the motor and/or speed control.

		Spur Gear		
		62	65	68
Pinion Gear	12	-	-	29.57
	13	-	-	27.29
	14	-	24.23	25.34
	15	-	22.61	23.65
	16	-	21.20	22.18
	17	19.03	19.95	20.87
	18	17.97	18.84	19.71
	19	-	17.85	18.67
	20	-	-	17.74
	21	-	-	-
	22	-	-	-

- Stock factory gearing
- Not for 14-cell battery running
- Not recommended

Adjusting the Steering System

1. Disconnect the short steering link that connects the servo saver to the servo horn.
2. Remove the drag link that connects the two servo horns.
3. Remove the servo horns
4. Connect a pair of charged batteries to the ESC. Turn on the transmitter, then the ESC. **Note:** It is recommended to unplug the motors or remove the pinion gears during steering setup.
5. Adjust the steering trim on the transmitter to the neutral "0" position.
6. Install both servo horns. Make sure they are parallel to the center line of the chassis (pointing to the rear of the truck).
7. Connect the short steering link from the servo saver to the servo horn. Make sure the servo saver is parallel to the center line of the chassis (also parallel to the servo horns). If not, make small adjustments to the length of the link so the everything is parallel.



8. The steering should operation correctly with equal travel left and right. Now connect the second servo.
9. Confirm the length of the center drag link (89.5mm - see template, below).

Center Drag Link

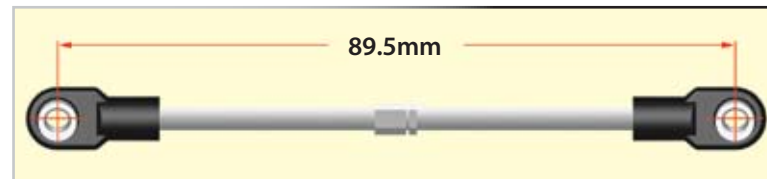

10. Connect the center drag link to one of the steering servos. Check for alignment with the holes in the second steering link. If these do not line up, make small adjustments to the length of the link until the holes line up.
11. Connect the center drag link to the second steering servo horn.
12. If necessary, fine tune the length of the center link to eliminate any load on the steering system in the neutral position.

If you are using aftermarket servos, it is important to use servo horns designed for E-Maxx. Optional steering servo horns are sold separately for use with non-Traxxas servos.

MAINTAINING YOUR MODEL

Your model requires timely maintenance in order to stay in top running condition. **The following procedures should be taken very seriously.**

Inspect the vehicle for obvious damage or wear. Look for:

1. Cracked, bent, or damaged parts
2. Check the wheels and steering for binding.
3. Check the operation of the shock absorbers.
4. Check the wiring for any frayed wires or loose connections.
5. Check the mounting of the receiver and servo(s) and speed control.
6. Check the tightness of the wheel nuts with a wrench.
7. Check the operation of the radio system, especially the condition of the batteries.
8. Check for any loose screws in the chassis structure or suspension.
9. Inspect the gears for wear, broken teeth, or debris lodged between the teeth.
10. Check the tightness of the slipper clutch.
11. Check the tightness of the front pivot balls.

Other periodic maintenance:

⚙️ Slipper clutch pads (friction material):

Under normal use, the friction material in the slipper clutch should wear very slowly. If the thickness of any one of the slipper clutch pads is 1.8mm or less, the friction disc should be replaced.

Measure the pad thickness using calipers or measuring against the diameter of the 1.5 and 2.0mm hex wrenches provided with the model.



- #### ⚙️ Chassis: Keep the chassis clean of accumulated dirt and grime. Periodically inspect the chassis for damage.

- #### ⚙️ Motors: Every 10-15 runs, remove, clean, and lubricate the motors. Use a product such as electric motor cleaning spray to flush dirt out of the motors. After cleaning, lubricate the bushings at each end of the motors with a drop of light-weight electric motor oil.

- #### ⚙️ Shocks: Keep the oil level in the shocks full. Use only 100% pure silicone shock oil to prolong the life of the seals. If you are experiencing leakage around the top of the shock, inspect the bladder in the top cap for signs of damage or distortion from overtightening. If the bottom of the shock is leaking, then it is time for a rebuild. The Traxxas rebuild kit for two shocks is part #2362.

- #### ⚙️ Suspension: Periodically inspect the model for signs of damage such as bent or dirty suspension pins, bent turnbuckles, loose screws, and any signs of stress or bending. Replace components as needed.

- #### ⚙️ Driveline: Inspect the driveline for signs of wear such as worn drive yokes, dirty axle half shafts, and any unusual noise or binding. Remove the gear cover and inspect the spur gear for wear and check the tightness of set screws in the pinion gears. Tighten, clean, or replace components as needed.

Storage

When you are through running the model for the day, blow it off with compressed air or use a soft bristled paint brush to dust-off the vehicle. Always disconnect and remove the batteries from the model whenever the model is stored. If the model will be stored for a long time, then also remove the batteries from the transmitter.



Always wear eye protection when using compressed air or spray cleaners and lubricants.

TROUBLESHOOTING

The following section addresses some very basic ESC and radio questions you may have about your model. Most questions arise from simple user errors or minor adjustments that are easy to correct. If you can't find a solution for your model here, then visit our website at www.Traxxas.com/support. There you will find a much more extensive and detailed online troubleshooting area. In addition, you may call Traxxas Customer Service at 1-888-TRAXXAS (outside the US call 972-265-8000).

Radio system does not work properly:

- ☞ If the power light on the transmitter does not come on, check for proper battery installation and that the batteries are new and/or fully charged. If the power light is blinking, then the transmitter batteries are weak and should be replaced. See page 11 for more details.
- ☞ If the transmitter light is on but the radio is still not responding, check for proper installation of batteries in the model and that the batteries are new and/or fully charged. Check to make sure the on/off switch on the model is in the on position. Check for damaged wires, a loose crystal, or loose connections. See page 11 for more details.

Short radio range:

- ☞ If the radio range appears short, then first check to make sure the transmitter antenna is fully extended and that the antenna in the model is in place and has not been cut or damaged. Next, make sure the batteries are all fully charged. Finally, if you are still experiencing short range, try a different location. Sometimes there can be interference from various sources that can cause your radio to malfunction.

Steering channel works, but the motor(s) will not run:

- ☞ The motor(s) could be bad or have a damaged brush. Check the motor(s) and motor connections by supplying power directly to the motor(s).
Note: Disconnect the motor(s) from the ESC before testing. Remove the pinion gear from the motor(s) or elevate the driving wheels to avoid a runaway and damage to the vehicle.
- ☞ The speed control has thermally shut down (look for a solid green LED). Allow the speed control to cool down. See the overheating section.
- ☞ Make sure the EVX-2's power cable is plugged into the throttle channel of the receiver (Channel 2). Check the operation of the radio system's throttle channel with a servo.
- ☞ Possible internal damage. Contact Traxxas for service.

EVX-2 will not go into programming mode:

- ☞ Make sure the EVX-2 is plugged into Channel 2 (the throttle channel) on the receiver. If it is plugged into Channel 3 or the battery terminal, it will not go into programming mode.
- ☞ Be sure the EVX-2 is turned off before trying to program or select a profile.
- ☞ Unplug batteries, reconnect, and repeat programming instructions.

Steering servos do not work:

- ☞ Check the wires, radio system, crystals, battery and motor connectors, and the battery packs.
- ☞ Possible internal damage. Contact Traxxas for service.

Motor(s) run backwards:

- ☞ Motor(s) wired backwards: check the wiring and correct.
- ☞ Backwards motor timing: reverse the motor end bells.

Receiver glitches/throttle stutters during acceleration:

- ☞ Motor capacitors broken or missing: check and replace the capacitors.
- ☞ The receiver or antenna is too close to power wires or batteries.
- ☞ Bad connections: check the wiring and connectors.
- ☞ Motor worn: replace the motor.
- ☞ Excessive current to the motor: use a milder motor or a smaller pinion gear.

Model runs slowly / slow acceleration:

- ☞ Check the motor and battery connectors.
- ☞ Check to see if EVX-2 is in Profile #3 (50% throttle)
- ☞ Bad battery or motor: check the operation with known good batteries (freshly charged) and motor.
- ☞ Incorrect transmitter or speed control adjustment. Reprogram the EVX-2.
- ☞ Motor is improperly geared: use a milder motor or a smaller pinion gear.
- ☞ Check the drive train for binding or restrictions.
- ☞ Gear mesh too tight or binding, refer to "Adjusting Gear Mesh" on page 23.

EVX-2 overheats and shuts down:

- ☞ Overloading the motor (running through tall grass, binding in the drivetrain).
- ☞ Insufficient ventilation for the heat sinks. Cut ventilation holes in the body or relocate the EVX-2.
- ☞ Motor may exceed maximum specification. The EVX-2 is limited to motors with no fewer 12-turns (550 size) with Traxxas High-Current Connectors.
- ☞ Motor is improperly geared. Use a milder motor or a smaller pinion gear.
- ☞ Check the drivetrain for restrictions.

Model will not go in reverse:

- ☞ Make sure the throttle trim is in the correct position (green light on EVX-2 should be solid)
- ☞ Check for correct EVX-2 profile (Profile #2 does not have reverse).

Motor runs as soon as the batteries are plugged in:

- ☞ Before turning on EVX-2: Internal damage, Contact Traxxas for service.

Keep stripping spur gears:

- ☞ Improper gear mesh, refer to "Adjusting Gear Mesh" on page 23.
- ☞ Loose motor. Readjust mesh and tighten the motor screws.

- Alignment Settings, 22
- Antenna
 - mount, 6
 - receiver, 9, 11
 - antenna crimp nut, 11
 - antenna nut wrench, 5, 11
 - transmitter, 13
- Axle carrier, 6, 20, 22
- Batteries
 - AA alkaline batteries, 5, 10
 - AA rechargeable batteries, 5, 10
 - charging, 4, 12
 - compartment, 6
 - installing, 12
 - LiPo, 5, 12, 23
 - NiCad, 10
 - NiMH, 10
 - safety, 4
 - side-by-side packs, 12
 - stick packs, 12
- Battery Hold-Down, 6, 12
- BEC (Battery Eliminator Circuit), 10
- Bellcrank, 23
- Body Mount, 6
- Brushless, 23
- Bulkhead, 6
- Bumper, 6
- Camber, 22
- Caster, 20
- Charger, 12
- Charging; *see Batteries: charging*
- Chassis, 6
 - maintenance, 25
- Crystal (X-tal), 9, 10
- Decals, 8
- Differential (Diff), 6
- Driveline, 25
- Driving, 17, 18, 19
 - wet conditions, 17, 18, 19
- Electronic Speed Control (EVX-2), 6, 9, 10, 15, 16
 - fast mode changes, 16
 - heat sinks, 4, 9
 - LED, 9, 14, 15, 16, 26
 - operation, 15
 - profile selection, 16
 - Race mode, 16
 - setup programming, 15
 - specifications, 15
 - Sport mode, 16
 - Training mode, 16
 - transmitter adjustments, 15
- ESC; *see Electronic Speed Control (EVX-2)*
- Gears (Gearing), 23
 - gear mesh, 23
 - gear ratio, 23
- Half Shaft, 6
- Hex hub, 6
- High-Current Connector, 9, 12, 13
- mAh, 10, 17
- Maintenance, 25
- Molex Connector, 12, 13
- Motor (Titan), 6, 9, 23
 - maintenance, 25
- Pinion Gear, 23
- Pivot ball, 6, 25
 - adjusting caps, 20
 - camber adjustment, 22
- Quick Start, 7
- Radio System (TQ), 9–14
 - adjustment, 13
 - channel, 9, 10
 - controls, 13
 - frequency band, 10
 - clearing your, 10, 14
 - range-testing, 14
 - rules, 14
 - setup, 14
 - terminology, 10
 - transmitter, 9, 10
 - batteries, 10, 11
 - light flashes, 11
 - servo reversing switch, 13
 - throttle neutral adjustment, 13
 - trim, 9, 10, 13
 - wiring, 9
- Receiver, 9, 10, 19
 - box, 19
- Ride Height, 21
- Run Time, 17
- Safety, 4
- Servos, 6, 10
 - servo horn, 23
 - servo saver, 23
- Set Button, 9
- Shocks (Oil Damper)
 - fine tuning, 20
 - mounting positions, 20–21
 - ride height, 21
 - shock tower, 6
 - spring rate, 21
- Skid plate, 6
- Slipper Clutch, 6, 22, 25
- Speed control; *see Electronic Speed Control (EVX-2)*
- Spring Rate, 21
- Spur Gear, 23
- Steering System, 23
 - adjusting, 24
 - drag link, 23, 24
- Storage, 25
- Suspension Arm, 6
- Suspension Maintenance, 25
- Suspension Tuning, 20
- Thermal Shutdown Protection, 10
- Tires, 22
 - tire gluing, 8
- Toe-in, 22
- Toe link, 6, 20, 22, 23, 25
- Tools, 5
- Training Mode, 16
- Transmission, 6
 - tuning, 22
- Transmitter; *see Radio System (TQ): transmitter*
- Troubleshooting, 26
- Tuning Adjustments, 20–24
- Turnbuckle; *see Toe link*
- Turning on the model, 14
- Wheels, 22

E-MAXX[®]

OWNERS MANUAL

MODEL 3905

TRAXXAS[®]

1100 KLEIN ROAD, PLANO TEXAS 75074

1-888-TRAXXAS

Free Manuals Download Website

<http://myh66.com>

<http://usermanuals.us>

<http://www.somanuals.com>

<http://www.4manuals.cc>

<http://www.manual-lib.com>

<http://www.404manual.com>

<http://www.luxmanual.com>

<http://aubethermostatmanual.com>

Golf course search by state

<http://golfingnear.com>

Email search by domain

<http://emailbydomain.com>

Auto manuals search

<http://auto.somanuals.com>

TV manuals search

<http://tv.somanuals.com>