

MP3-CD Soundmachine

AZ1226

Meet Philips at the Internet

<http://www.philips.com>

User manual

使用说明书

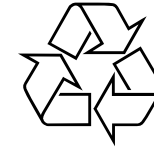

AZ 1226



PHILIPS

Printed in China

YM-621-1

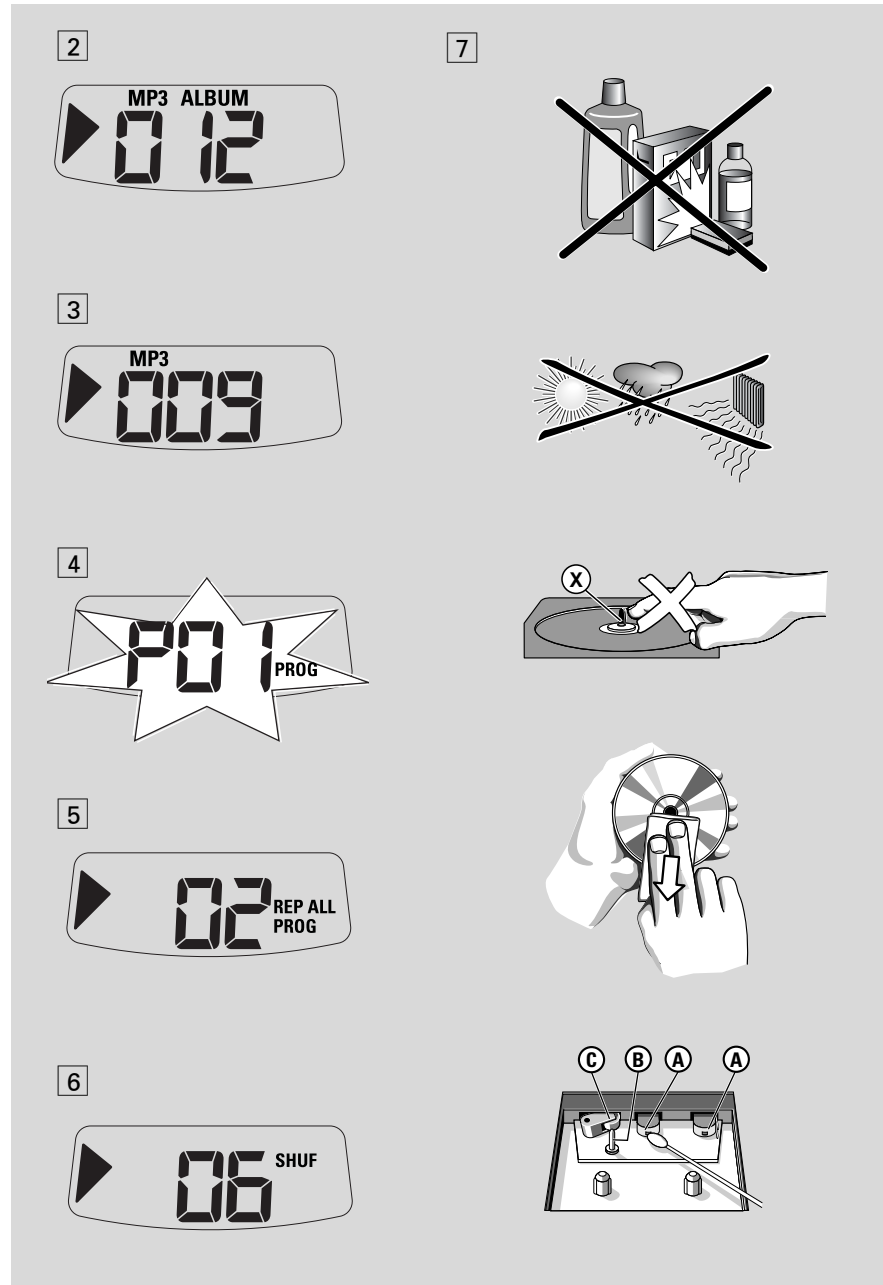
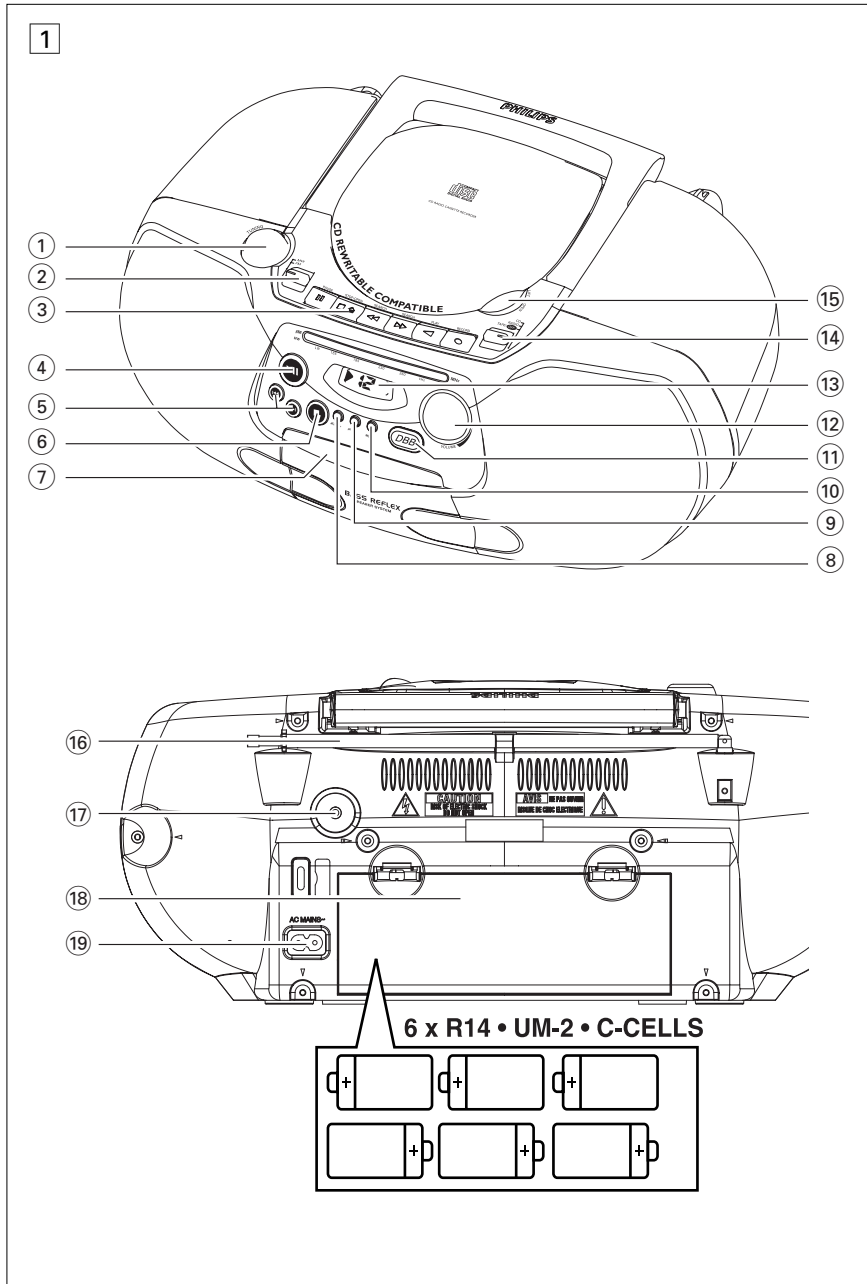

English

Supplied accessories

AC power cord

Top and front panels (See 1)

- ① **TUNING** – tunes to radio stations
- ② **MW•FM** – selects wavebands, MW or FM
- ③ **Cassette recorder keys:**
 - PAUSE II** – pauses playback or recording
 - STOP•OPEN ■▲**
 - stops playback or recording.
 - opens the cassette holder.
 - SEARCH ◀◀ or ▶▶** – fast winds/rewinds the tape
 - PLAY ◀** – starts playback
 - RECORD ●** – starts recording
- ④ **▶II** - starts or pauses disc playback.
- ⑤ **SEARCH ◀◀ ▶▶** – skips or searches a passage/track backward or forward.
- ⑥ **■** – stops disc playback;
 - erases a program;
- ⑦ **Cassette door**
- ⑧ **ALBUM+ (up)**
 - **For MP3-CD only:** select albums
- ⑨ **PROG** – programs tracks and reviews the program
- ⑩ **MODE** – selects different play modes: e.g. REPEAT or SHUFFLE (random order)
- ⑪ **DBB (DYNAMIC BASS BOOST)**
 - turns the bass enhancement on/off.
- ⑫ **VOLUME** – adjusts volume level
- ⑬ **Display** – shows disc functions
- ⑭ **Source selector : CD/MP3, RADIO, TAPE/OFF**
 - selects CD/MP3-CD, radio or tape source of sound
 - switches off the set
- ⑮ **LIFT TO OPEN** – lift here to open the disc door

Controls / Power Supply

Back panel

- ⑯ **Telescopic antenna** - improves FM reception.
- ⑰ **🔊** - 3.5mm stereo headphone jack
- ⑱ **Battery door** - open to insert 6 x 1.5V **R-14/ UM2/ C-cells.**
- ⑲ **AC MAINS** - inlet for power cord.

CAUTION

Use of controls or adjustments or performance of procedures other than herein may result in hazardous radiation exposure or other unsafe operation.

Power Supply

Whenever convenient, use the power supply cord if you want to conserve battery life. Make sure you remove the plug from the set and wall outlet before inserting batteries.

Batteries (not included)

- 1 Open the battery compartment and insert six batteries, type **R-14, UM-2** or **C-cells**, (preferably alkaline) with the correct polarity as indicated by the "+" and "-" symbols inside the compartment (See 1).
- 2 Replace the compartment door, making sure the batteries are firmly and correctly in place. The set is now ready to operate.

Batteries contain chemical substances, so they should be disposed of properly.

Power Supply

- Incorrect use of batteries can cause electrolyte leakage and will corrode the compartment or cause the batteries to burst.
- Do not mix battery types: e.g. alkaline with carbon zinc. Only use batteries of the same type for the set.
- When inserting new batteries, do not try to mix old batteries with the new ones.
- Remove the batteries if the set is not to be used for a long time.

Using AC power

- 1 Check if the power/mains voltage, **as shown on the type plate located on the bottom of the set**, corresponds to your local power supply. If it does not, consult your dealer or service center.
 - 2 If your set is equipped with a voltage selector, adjust the selector so that it matches with the local power supply.
 - 3 Connect the power cord to the **AC MAINS** inlet and the wall socket. The set is now ready for use.
 - 4 To switch the set off completely, withdraw the power cord from the wall socket.
- Disconnect the power cord from the wall socket to protect your set during heavy thunderstorms.
- The type plate is located on the bottom of the set.**

Helpful hints:

- To avoid unnecessary energy consumption, always adjust the **source selector** to **TAPE/OFF** after using the set. Also check that the tape deck keys are released.

Basic Function / Radio

Basic functions

Switching on/off the set:

- 1 To switch on, adjust the **source selector** to **CD/MP3, RADIO** or **TAPE/OFF** as desired.
- 2 To switch off, adjust the **source selector** to **TAPE/OFF** and check the cassette keys are released.

Adjusting volume and sound

Adjust the sound with the **VOLUME** and **DBB** (Dynamic Bass Boost) controls.

Radio reception

- 1 Push the **source selector** to **RADIO**.
- 2 Adjust the **MW•FM** to **MW** or **FM** to select your desired waveband.
- 3 Turn **TUNING** to tune to a radio station.
- 4 To switch off the radio, adjust the **source selector** to **TAPE/OFF** and check the cassette keys are released.

Helpful hints:

To improve reception

- For **FM**, extend, incline and turn the telescopic antenna. Reduce its length if the signal is too strong.
- For **MW**, uses a built-in antenna. Direct this antenna by turning the whole set.

MP3-CD/ CD Player

About MP3

The music compression technology MP3 (MPEG1 Audio Layer 3) significantly reduce the digital data of an audio CD while maintaining CD quality sound.

- **Getting MP3 files:** you can either download legal music files from the internet to your computer hard disc, or create such files by converting audio CD files in your computer through appropriate encoder software. (128kbps bit rate or higher is recommended for MP3 files.)
- **Creating a MP3 CD:** burn the music files from your computer hard disc on a CDR or CDRW using your CD burner.

Helpful Hints:

- Make sure that the file names of the MP3 files end with **.mp3**.
- Total number of music files and albums: around 350 (with a typical file name length of 20 characters)
- The length of file names affects the number of tracks for playback. With shorter file names, more files can be burned on a disc.

Playing a disc

This player plays Audio Discs including CD-R/CD-RW, and MP3 CD. Do not try to play a CD-ROM, CD-I, CDV, VCD, DVD or computer CD.

IMPORTANT!

- CDs encoded with **copyright protection technologies** by some record companies may be unplayable by this product.
 - For a disc with CD Audio tracks and MP3 files, only the CD Audio tracks will be played.
- 1 Adjust the **source selector** to **CD/MP3**.
→ Display: - - - appears.
 - 2 To open the disc door, lift the disc door at the edge marked **LIFT TO OPEN**.

- 3 Insert a disc with the printed side facing up and press the disc door gently close.
→ Display: The total number of tracks appears.
- 4 Press **▶II** to start playback.
→ Display: ▶ and the current track number.
For MP3-CD only:
→ The current track number "X.XX" and album number "ALBUM XXX" will be displayed interchangeably. (See [2] [3])
- 5 To pause playback press **▶II**.
→ Display: ▶ flashes.
- 6 Press **▶II** again to resume playback.
- 7 To stop playback, press **■**.

Helpful Hints:

- The disc playback will also stop when:
- you open the disc compartment;
 - you select **RADIO** or **TAPE** sound source;
 - the disc has reached the end of the playback.

Selecting a different track

- Press **◀◀** or **▶▶** once or repeatedly until the desired track number appears in the display.
For MP3-CD: First press **ALBUM +** (up) once or more to find your album.
- In the pause/stop position, press **▶II** to start playback.

Finding a passage within a track

- 1 During playback, press and hold down **◀◀** or **▶▶**.
→ The disc is played at high speed and low volume.
- 2 When you recognize the passage you want release **◀◀** or **▶▶**.
→ Normal playback resumes.

Helpful Hints:

- When your searching reaches the end of the last track, the disc playback stops.

MP3-CD/CD Player

Programming tracks

You may store up to 20 tracks (for MP3-CD: 10 tracks) in the desired sequence. If you like, store any track more than once.

- 1 In the stop position, press **PROG** to start programming.
→ Display shows **PQ!** indicating the start of the program. **PROG** flashes. (See [4])
- 2 Press **◀◀** or **▶▶** to select your desired track number.
For MP3-CD: first press **ALBUM +** once or more to find your album.
- 3 Press **PROG** to store the desired track.
→ Display shows **PQ?** (up to **PQ!** or **!Q** in sequence), indicating the next program location available.
- 4 Repeat steps **2** to **3** to select and store all desired tracks.
- 5 Press **▶II** to play the program.

To review your program

- In the stop position, press and hold **PROG** 2 seconds.
→ The display shows all the stored tracks in sequence.

Helpful Hints:

- Display shows **PQ!** if no track is programmed
- If you try to store more than 20 tracks (for MP3-CD: 10 tracks), no track can be selected and the display will show **P - -**.

To erase a program

- You can erase a program by:
- pressing **■** (twice during playback or once in the stop position);
 - selecting **RADIO** or **TAPE** sound source;
 - opening the disc door;
- Display: **PROG** disappears.

Selecting different play modes (See [5], [6])

You can select and change the various play modes before or during playback, and combine REPEAT modes with **PROG**.





- REP** – plays the current track continuously.
REP ALL – plays the entire disc/program continuously.
SHUF – plays all tracks in random order:

- 1 To select play modes, press **MODE** once or more.
- 2 Press **▶II** to start playback if in the stop position.
- 3 To select normal playback, press **MODE** repeatedly until the various modes are no longer displayed.
– You can also press **■** to cancel your play modes.



Cassette Recorder

Tape operation/recording

Playing a tape

- 1 Adjust the **source selector** to **TAPE/OFF**.
- 2 Press **STOP•OPEN**  to open the cassette holder; insert a cassette and close the deck.
- 3 Press **PLAY**  to start playback.
- 4 To pause playback press **PAUSE** .
- 5 To resume, press **II** again.
- 6 To stop the tape, press .

Fast forwarding/rewinding

- 1 Press **SEARCH**  or  until you reach your desired passage.
- 2 Press  to stop rewinding/fast forwarding.



Helpful Hints:

- During playback, the keys are automatically release at the end of a tape, and the set is switched off (except if **II** has been activated).
- During fast forwarding/rewinding, the keys will not be released at the end of a tape. To switch off the set, make sure the cassette keys are also released.

General information on recording

- Recording is permissible insofar as copyright or other rights of third parties are not infringed.
- For recording, use only NORMAL type cassettes (IEC type I) on which the tabs have not yet been broken. This deck is not suited for recording on CHROME (IEC II) or METAL (IEC IV) type cassettes.
- The best recording level is set automatically. Altering the **VOLUME** and **DBB** controls will not affect the recording.
- To protect a tape from accidental erasure, break out the tabs. If you wish to record again, cover the tabs with a piece of adhesive tape.

CD/MP3-CD synchro start recording

- 1 Select **CD/MP3** source.
- 2 Insert a disc and if desired, program track numbers.
- 3 Press  to open the cassette holder. Insert a blank tape and close the deck.
- 4 Press **RECORD**  to start recording.
 - Playing of the disc/ programme starts automatically from the beginning. You don't need to start the player separately.
- 5 For brief interruptions, press **II**. To resume recording, press **II** again.
- 6 To stop recording, press .

Recording from the Radio

- 1 Adjust the source selector to **RADIO**.
- 2 Tune to a desired radio station (See **Radio reception**)
- 3 Follows steps 3-6, under **CD/MP3 synchro start recording**.

The making of unauthorized copies of copy-protected material, including computer programmes, files, broadcasts and sound recordings, may be an infringement of copyrights and constitute a criminal offence. This equipment should not be used for such purposes.

 **Be responsible
Respect copyrights**



Maintenance & Safety

Safety information (See)

- Place the set on a hard, flat and stable surface so that the system does not tilt.
- Do not expose the set, batteries, CDs to humidity, rain, sand or excessive heat caused by heating equipment or direct sunlight.
- The apparatus shall not be exposed to dripping or splashing.
- Adequate ventilation with a minimum gap of 15 cm between the ventilation holes and surrounding surfaces is necessary to prevent heat build-up.
- The ventilation should not be impeded by covering the ventilation openings with items, such as newspapers, table-cloths, curtains, etc..
- No objects filled with liquids, such as vases, shall be placed on the apparatus.
- No naked flame sources, such as lighted candles, should be placed on the apparatus.
- The mechanical parts of the set contain self-lubricating bearings and must not be oiled or lubricated.
- To clean the set, use a dry cloth. Do not use any cleaning agents containing alcohol, ammonia, benzene or abrasives as these may harm the housing.

Tape deck maintenance (See)

To ensure quality recording and playback of the tape deck, clean parts (A), (B) and (C) as shown, once a month. Use a cotton bud slightly moistened with alcohol or a special head cleaning fluid to clean the deck.

- 1 Open the cassette holder by pressing .
- 2 Press  and clean the roller (C).
- 3 Press **II** and clean the heads (A), and the capstan (B).
- 4 After cleaning, press .
→ Cleaning of the heads can also be done by playing a cleaning cassette through once.

CD player and CD handling (See)

- If the CD player cannot read CDs correctly, use a cleaning CD to clean the lens before taking the set to repair.
- The lens of the CD player should never be touched!
- Sudden changes in the surrounding temperature can cause condensation on the lens of your CD player. Playing a CD is then not possible. Do not attempt to clean the lens but leave the set in a warm environment until the moisture evaporates.
- Always close the CD-tape door to avoid dust on the lens.
- To clean the CD, wipe in a straight line from the center towards the edge using a soft, lint-free cloth. Do not use cleaning agents as they may damage the disc.
- Never write on a CD or attach any stickers to it.

Troubleshooting

If a fault occurs, first check the points listed below before taking the set for repair.
If you are unable to remedy a problem by following these hints, consult your dealer or service centre.

WARNING: Do not open the set as there is a risk of electric shock. Under no circumstances should you try to repair the set yourself, as this will invalidate the guarantee.

No sound /power

- Volume not adjusted
- Adjust the VOLUME
- Power cord not securely connected
- Connect the AC power cord properly
- Batteries dead/ incorrectly inserted
- Insert (fresh) batteries correctly
- Headphones connected to the set
- Disconnect headphones
- Disc contains non-audio files
- Insert a suitable disc or press **SEARCH** ◀◀ or ▶▶ once or more skip to an audio track, instead of the data files

Display does not function properly/No reaction to operation of any of the controls

- Electrostatic discharge
- Switch off and unplug the set. Reconnect after a few seconds

no indication

- No disc inserted
- Insert a suitable disc
- Disc badly scratched or dirty
- Replace/clean CD (See Maintenance)
- CD-R(W) is blank or the disc is not finalized.
- Use a finalized CD-R(W)
- Laser lens steam up
- Wait until lens has cleared

Note:

Make sure the CD is not encoded with Copyright protection technologies, as some do not conform to the Compact Disc standard.

The disc skips tracks

- Disc damaged or dirty
- Replace or clean disc
- Shuffle or program is active
- Switch off shuffle/program

Note:

For a disc with CD Audio tracks and MP3 files, only the CD Audio tracks will be played.

Sound skips during MP3 playback

- MP3 file made at compression level exceeding 320kbps
- Use a lower compression level to record CD tracks into MP3 format
- Disc damaged or dirty
- Replace or clean disc

Poor cassette sound quality

- Dust and dirt on the heads, etc.
- Clean deck parts, see Maintenance
- Use of incompatible cassette types (METAL or CHROME)
- Only use NORMAL (IEC I) for recording

Recording does not work

- Cassette tab(s) may be broken
- Apply adhesive tape over the missing tab space

Environmental information

All unnecessary packaging material has been omitted. The packaging can be easily separated into three materials: cardboard, polystyrene and plastic.

Your set consists of materials which can be recycled if disassembled by a specialized company. Please observe the local regulations regarding the disposal of packaging, dead batteries and old equipment.

Free Manuals Download Website

<http://myh66.com>

<http://usermanuals.us>

<http://www.somanuals.com>

<http://www.4manuals.cc>

<http://www.manual-lib.com>

<http://www.404manual.com>

<http://www.luxmanual.com>

<http://aubethermostatmanual.com>

Golf course search by state

<http://golfingnear.com>

Email search by domain

<http://emailbydomain.com>

Auto manuals search

<http://auto.somanuals.com>

TV manuals search

<http://tv.somanuals.com>