

Always there to help you

Register your product and get support at
www.philips.com/welcome

AZ783



User Manual

PHILIPS

Contents

9	Troubleshooting	13
---	-----------------	----

10	Notice	14
----	--------	----

1	Important	3
	Risk of swallowing batteries	4

2	Your CD Soundmachine	4
	Introduction	4
	What's in the box	4
	Overview of the main unit	5
	Overview of the remote control	6

3	Get started	7
	Prepare the remote control	7
	Connect power	7
	Turn on	8
	Turn off	8

4	Play	8
	Play CD	8
	Play from USB devices	8
	Play from an external device	9

5	Play options	9
	Control play	9
	Program tracks	10
	Adjust sound	10

6	Listen to FM radio	10
	Tune to FM radio stations	10
	Store radio stations automatically	10
	Store radio stations manually	11
	Select a preset radio station	11

7	Other features	11
	Set the sleep timer	11
	Turn screen backlight on/off	11
	Listen through the headphone	11

8	Product information	12
	Specifications	12
	Supported MP3 disc formats	12
	USB playability information	12
	Maintenance	13

1 Important

- Read these instructions.
- Follow all instructions.
- Do not block any ventilation openings. Install in accordance with the manufacturer's instructions.
- Do not install near any heat sources such as radiators, heat registers, stoves, or other apparatus (including amplifiers) that produce heat.
- Protect the power cord from being walked on or pinched, particularly at plugs, convenience receptacles, and the point where they exit from the unit.
- Only use attachments/accessories specified by the manufacturer.
- Unplug this unit during lightning storms or when unused for long periods of time.
- Refer all servicing to qualified service personnel. Servicing is required when the unit has been damaged in any way, such as power-supply cord or plug is damaged, liquid has been spilled or objects have fallen into the apparatus, the unit has been exposed to rain or moisture, does not operate normally, or has been dropped.
- Battery usage CAUTION – To prevent battery leakage which may result in bodily injury, property damage, or damage to the unit:
 - Install all batteries correctly, + and - as marked on the unit.
 - Do not mix batteries (old and new or carbon and alkaline, etc.).
 - Remove batteries when the unit is not used for a long time.
- Batteries (battery pack or batteries installed) shall not be exposed to excessive heat such as sunshine, fire or the like.
- CAUTION: Danger of explosion if battery is incorrectly replaced. Replace only with the same or equivalent type.
- The unit shall not be exposed to dripping or splashing.

- Do not place any sources of danger on the unit (e.g. liquid filled objects, lighted candles).
- Where the MAINS plug or an appliance coupler is used as the disconnect device, the disconnect device shall remain readily operable.

Warning

- Never remove the casing of this apparatus.
- Never place this apparatus on other electrical equipment.
- Never look into the laser beam inside this apparatus.

Hearing safety



Caution

- To prevent possible hearing damage, do not listen at high volume levels for long periods. Set the volume to a safe level. The louder the volume, the shorter is the safe listening time.

Be sure to observe the following guidelines when using your headphones.

- Listen at reasonable volumes for reasonable periods of time.
- Be careful not to adjust the volume continuously upwards as your hearing adapts.
- Do not turn up the volume so high that you can't hear what's around you.
- You should use caution or temporarily discontinue use in potentially hazardous situations.
- Excessive sound pressure from earphones and headphones can cause hearing loss.

Caution

- Use of controls or adjustments or performance of procedures other than herein may result in hazardous radiation exposure or other unsafe operation.

Risk of swallowing batteries

- The product or remote control may contain a button cell battery, which is possible to be swallowed. Keep the battery out of reach of children at all times! If swallowed, the battery can cause serious injury or death. Severe internal burns can occur within two hours of ingestion.
- If you suspect that a battery has been swallowed or placed inside any part of the body, seek immediate medical attention.
- When you change the batteries, always keep all new and used batteries out of reach of children. Ensure that the battery compartment is completely secure after you replace the battery.
- If the battery compartment cannot be completely secured, discontinue use of the product. Keep out of reach of children and contact the manufacturer.

2 Your CD Soundmachine

Introduction

With this CD Soundmachine, you can:

- listen to FM radio;
- enjoy audio from discs, USB device, and other external audio devices;
- program the play sequence of tracks.

The unit offers you Dynamic Bass Boost (DBB) and Digital Sound Control (DSC) to enrich sound.





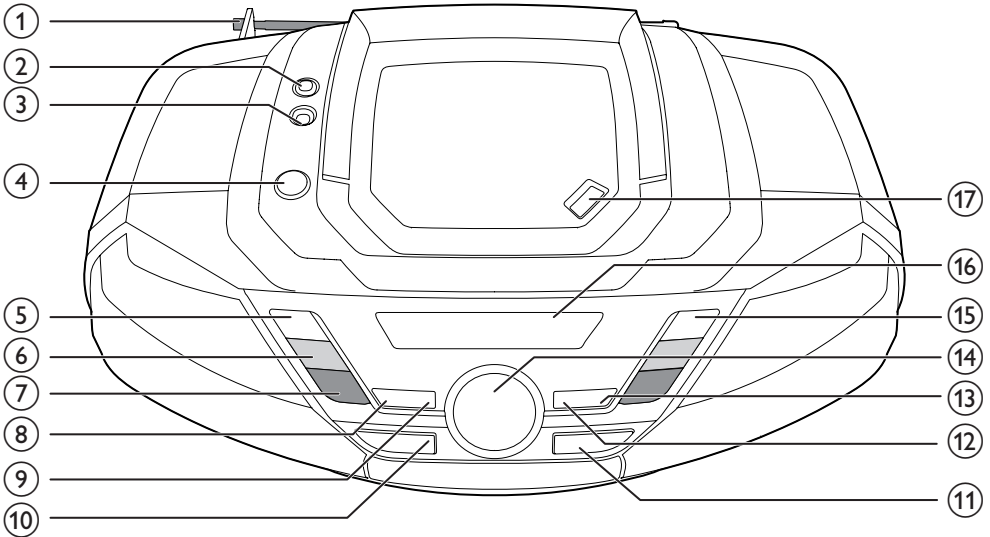

What's in the box

Check and identify the contents of the package:

- Main unit
- AC power cord
- Remote control (with battery)
- Short user manual
- Safety & notice leaflet

Overview of the main unit



- ① **FM antenna**
 - Improve FM reception.
- ②  **Headphone socket.**
- ③ **AUDIO-IN**
 - Connect an external audio device.
- ④  **Turn the unit on or off.**
- ⑤  **Stop play.**
 - Erase a program.
- ⑥  **TUNING +/-**
 - Skip to the previous or next track.
 - Tune to FM radio stations.
 - Search within a track.
- ⑦ **ALBUM/PRESET -/+**
 - Select a preset radio station.
 - Skip to the previous or next album.
- ⑧ **PROG**
 - Program tracks.
- ⑨ **MODE**
 - Select a play mode: repeat or shuffle.
- ⑩ **SOURCE**
 - Select a source.
- ⑪  **USB socket.**
- ⑫ **DBB**
 - Turn dynamic bass boost on or off.
- ⑬ **DSC**
 - Select a preset sound setting.
- ⑭ **VOL +/-**
 - Adjust volume.
- ⑮  **Start or pause play.**
- ⑯ **Display panel**
 - Display current status.
- ⑰ **OPEN•CLOSE**
 - Open or close the disc compartment.

Overview of the remote control

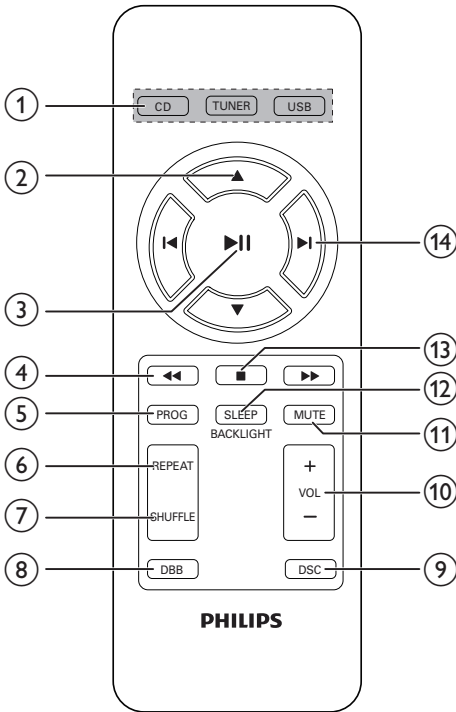

① Source selector: CD, TUNER, USB

- Select a source.

② ▲ / ▼

- Skip to the previous or next album.
- Select a preset radio station.

③ ▶ ||

- Start or pause play.

④ ◀◀ / ▶▶

- Search within a track.

⑤ PROG

- Program radio stations.
- Program tracks.

⑥ REPEAT

- Select repeat play mode.

⑦ SHUFFLE

- Select shuffle play mode.

⑧ DBB

- Turn dynamic bass boost on or off.

⑨ DSC

- Select a preset sound setting.

⑩ VOL +/-

- Adjust volume.

⑪ MUTE

- Mute or restore sound.

⑫ SLEEP/BACKLIGHT

- Set sleep timer.
- Turn the backlight on or off.

⑬ ■

- Stop play.
- Erase a program.

⑭ ◀ / ▶

- Skip to the previous or next track.

3 Get started

! Caution

- Use of controls or adjustments or performance of procedures other than herein may result in hazardous radiation exposure or other unsafe operation.

Always follow the instructions in this chapter in sequence.

If you contact Philips, you will be asked for the model and serial number of your apparatus. The model number and serial number are on the bottom of your apparatus. Write the numbers here:

Model No. _____

Serial No. _____

Prepare the remote control

For first-time use:

Remove the protective tab to activate the remote control battery.

To replace the exhausted battery:

- 1 Open the battery tray.
- 2 Insert one CR2025 battery with correct polarity (+/-) as indicated.

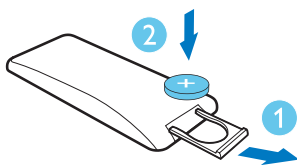

- 3 Close the battery tray.

Connect power

The unit can be powered by either AC power or batteries.

Option 1: AC power

! Warning

- Risk of product damage! Make sure that the power supply voltage corresponds to the voltage printed on the back or the underside of the unit.
- Risk of electric shock! When you disconnect the AC power, always pull the plug from the socket. Never pull the cord.

Connect the AC power cord to:

- the **AC~ MAINS** socket on the unit.
- the wall socket.

* Tip

- To save energy, turn the unit off after use.

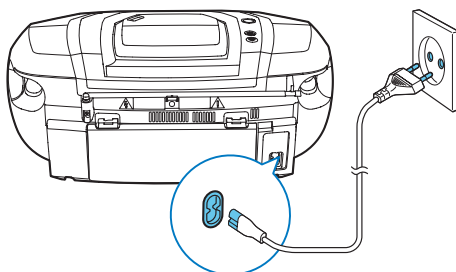

Option 2: Battery power

! Caution

- Batteries contain chemical substances, so they should be disposed of properly.

≡ Note

- Batteries are not supplied with the accessories.

- 1 Open the battery compartment.
- 2 Insert 6 batteries (type: R-20, UM-1 or D-cells) with correct polarity (+/-) as indicated.

3 Close the battery compartment.

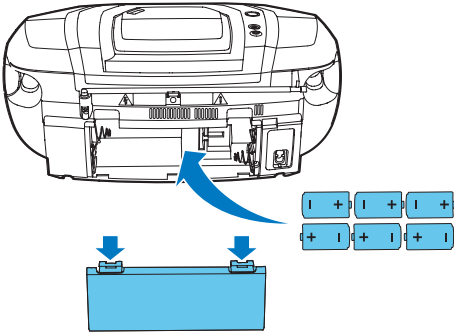

Turn on

Press **⏻**.

↳ The unit switches to the last selected source.



Tip

- To select a source, press **SOURCE** repeatedly or the source selection buttons on the remote control.

Turn off

Press **⏻** again.

↳ The backlight on the display panel turns off.

4 Play

Play CD

- 1 Press **CD** to select the disc source.
- 2 Press **OPEN•CLOSE** to open the disc tray.
- 3 Insert a disc with the printed side facing up, then close the disc tray.
↳ Play starts automatically.

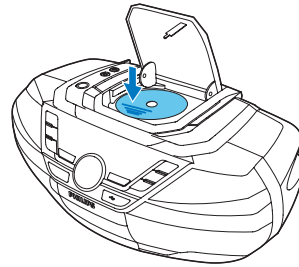

Play from USB devices

Note

- Make sure that the USB device contains playable audio content.

- 1 Press **USB** to select USB source.
- 2 Insert the USB device into the **USB** socket.
↳ Play starts automatically. If not, press **▶||**.

5 Play options

Control play

In CD or USB mode, you can control play through the following operations.

◀ / ▶▶	Press and hold to fast-forward or fast-reverse the track during playback, then release to resume play.
▲ / ▼	Skip to the previous or next MP3/WMA album.
◀ / ▶	Select an audio file.
▶▶	Start or pause play.
■	Stop play.
REPEAT	[↺]: Play the current track repeatedly. [↻ALL]: Play all tracks repeatedly. [↺↻ALL]: Repeat all tracks randomly. To return to normal play, press REPEAT repeatedly until the repeat icons disappears.
SHUFFLE	[↺↻]: Play tracks randomly. To return to normal play, press SHUFFLE repeatedly until the shuffle icon disappear.

 **Tip**

- Only [↺↻] and [↺↻ALL] can be selected when you play the programmed tracks.

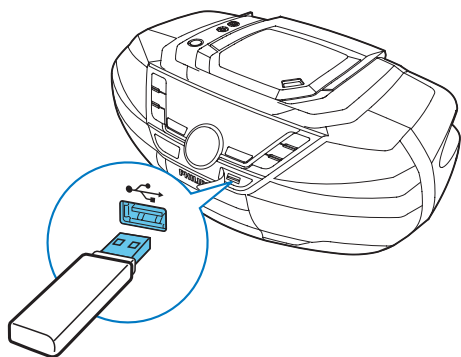

Play from an external device

You can also listen to an external audio device such as an MP3 player through this unit.

- 1 Press **SOURCE** repeatedly to select **[AUDIO-IN]** source.
- 2 Connect an audio cable (3.5mm, not supplied) to:
 - the **AUDIO-IN** socket on the unit.
 - the headphone socket on an external device.
- 3 Play the external device (see the device's user manual).

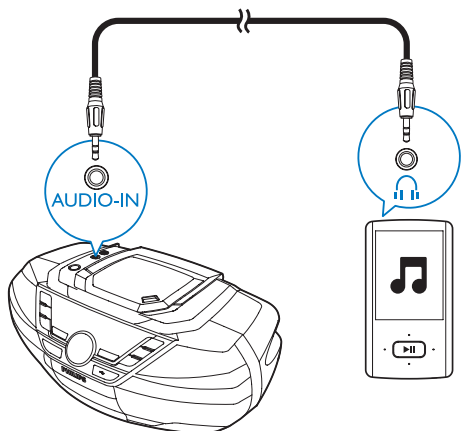

Program tracks

In CD or USB mode, you can program a maximum of 20 tracks.

- 1 Press **■** to stop playback.
- 2 Press **PROG** to activate the program mode.
↳ **[PROG]** (program) begins to blink.
- 3 For MP3/WMA tracks, press **ALBUM/PRESET +/-** to select an album.
- 4 Press **◀/▶** to select a track number, then press **PROG** to confirm.
- 5 Repeat steps 3-4 to program more tracks.
- 6 Press **▶||** to play the programmed tracks.
↳ During play, **[PROG]** (program) is displayed.
 - To erase the program, press **■** twice.

Adjust sound

During play, you can adjust volume and select the sound effects.

Key	Function
VOL +/-	Increase or decrease volume.
MUTE	Mute or resume sound.
DBB	Turn dynamic bass enhancement on or off.
DSC	Select a preset sound effect: ROCK (rock); CLASSIC (classic); POP (pop); JAZZ (jazz)

6 Listen to FM radio

Tune to FM radio stations

Note

- For optimal reception, fully extend and adjust the position of the FM antenna.
- The icon  indicates stereo broadcast is available for this radio station.

- 1 Press **TUNER** to select FM radio.
- 2 Press and hold **◀/▶** for 2 seconds.
↳ **[SEARCH]** (search) is displayed.
↳ The unit tunes to a station with strong reception automatically.
- 3 Repeat step 2 to tune to more stations.

To tune to a radio station with weak signal:
Press **◀/▶** repeatedly until you find better reception.

Store radio stations automatically

Note

- You can program a maximum of 30 FM radio stations.

In tuner mode, press and hold **PROG** for 2 seconds.

- ↳ **[AUTO STORE]** (auto store) is displayed.
- ↳ The unit stores all the available FM radio stations.
- ↳ The first stored radio station is broadcast automatically.

Store radio stations manually

Note

- You can program a maximum of 30 FM radio stations.

- 1 Tune to an FM radio station.
- 2 Press **PROG** to activate the storing mode.
↳ **[PROG]** (program) blinks on the display.
- 3 Press **▲▼** to allocate a number (1 to 30) to this radio station, then press **PROG** to confirm.
↳ The preset number and the frequency of the preset station are displayed.
- 4 Repeat the above steps to store other stations.

Note

- To remove a pre-stored FM radio station, store another station in its place.

Select a preset radio station

In FM tuner mode, press **▲▼** to select a preset number.

7 Other features

Set the sleep timer

This unit can switch to standby automatically after a preset period.

When the unit is turned on, press **SLEEP** repeatedly to select the sleep timer period (in minutes).

- ↳ When the sleep timer is activated, **z²** appears.

To deactivate sleep timer:

- Press **SLEEP** repeatedly until **[SLEEP OFF]** (sleep off) is displayed.
- ↳ When sleep timer is deactivated, **z²** disappears.

Turn screen backlight on/off

Press and hold **BACKLIGHT** for 2 seconds.

Listen through the headphone

Plug a headphone into the  socket on the unit.

8 Product information

Note

- Product information is subject to change without prior notice.

Specifications

Amplifier

Max Output Power	Total 12 W
Frequency Response	125 -16000 Hz, -3dB
Signal to Noise Ratio	>55 dBA
Total Harmonic Distortion	<1 %
Audio-in Input	650 mV RMS

Disc

Laser Type	Semiconductor
Disc Diameter	12cm/8cm
Support Disc	CD-DA, CD-R, CD-RW, MP3-CD, WMA-CD
Audio DAC	24Bits / 44.1kHz
Total Harmonic Distortion	<1%
Frequency Response	125 -16000 Hz, -3dB
S/N Ratio	>55 dBA

Tuner

Tuning Range	87.5 - 108MHz
Tuning grid	50 kHz
Total Harmonic Distortion	<3%
Signal to Noise Ratio	>50 dBA

General

Power supply	
- AC Power	220-240V~, 50/60 Hz;
- Battery	9V, 6 x 1.5 V Size "D"/ R20 CELL
Operation Power Consumption	15 W
Standby Power Consumption	<0.5 W
Dimensions	
- Main Unit (W x H x D)	435 x 170 x 271 mm
Weight (Main Unit)	2.5 kg

Supported MP3 disc formats

- ISO9660, Joliet
- Maximum title number: 512 (depending on file name length)
- Maximum album number: 255
- Supported sampling frequencies: 32 kHz, 44.1kHz, 48 kHz
- Supported Bit-rates: 32~256 (kbps), variable bit rates

USB playability information

Compatible USB devices:

- USB flash memory (USB 2.0 or USB1.1)
- USB flash players (USB 2.0 or USB1.1)
- memory cards (requires an additional card reader to work with this apparatus)

Supported formats:

- USB or memory file format FAT12, FAT16, FAT32 (sector size: 512 bytes)
- MP3 bit rate (data rate): 32-320 Kbps and variable bit rate
- WMA v9 or earlier
- Directory nesting up to a maximum of 8 levels
- Number of albums/ folders: maximum 99
- Number of tracks/titles: maximum 999
- ID3 tag v2.0 or later

- File name in Unicode UTF8 (maximum length: 128 bytes)

Unsupported formats:

- Empty albums: an empty album is an album that does not contain MP3/WMA files, and is not be shown in the display.
- Unsupported file formats are skipped. For example, Word documents (.doc) or MP3 files with extension .dlf are ignored and not played.
- AAC, WAV, PCM audio files
- DRM protected WMA files (.wav, .m4a, .m4p, .mp4, .aac)
- WMA files in Lossless format

Maintenance

Clean the cabinet

- Use a soft cloth slightly moistened with a mild detergent solution. Do not use a solution containing alcohol, spirits, ammonia or abrasives.

Clean discs

- When a disc becomes dirty, clean it with a cleaning cloth. Wipe the disc from the centre out.

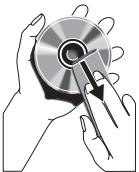

- Do not use solvents such as benzene, thinner, commercially available cleaners, or antistatic spray intended for analogue records.

Clean the disc lens

- After prolonged use, dirt or dust may accumulate at the disc lens. To ensure good play quality, clean the disc lens with Philips CD lens cleaner or any commercially available cleaner. Follow the instructions supplied with cleaner.

9 Troubleshooting



Warning

- Never remove the casing of this device.

To keep the warranty valid, never try to repair the system yourself.

If you encounter problems when using this device, check the following points before requesting service. If the problem remains unsolved, go to the Philips Web page (www.philips.com/support). When you contact Philips, make sure that the device is nearby and the model number and serial number are available.

No power

- Ensure that the AC power plug of the unit is connected properly.
- Ensure that there is power at the AC outlet.
- Insert the batteries with their polarities (+/- signs) aligned as indicated.
- Replace the battery.

No sound or poor sound

- Adjust the volume.

No response from the unit

- Disconnect and reconnect the AC power plug, then turn on the system again.
- As a power-saving feature, the unit switches off automatically 15 minutes after track play reaches the end and no control is operated.

Remote control does not work

- Before you press any function button, first select the correct source with the remote control instead of the main unit.
- Reduce the distance between the remote control and the unit.
- Insert the battery with its polarities (+/- signs) aligned as indicated.
- Replace the battery.

- Aim the remote control directly at the sensor on the front of the unit.

USB device not supported

- The USB device is incompatible with the apparatus. Try another one.

No disc detected

- Insert a disc.
- Check if the disc is inserted upside down.
- Wait until the moisture condensation at the lens has cleared.
- Replace or clean the disc.
- Use a finalized CD or correct format disc.

Poor radio reception

- Increase the distance between the unit and your TV or VCR.
- Fully extend the FM antenna.

10 Notice



This product complies with the radio interference requirements of the European Community.

Any changes or modifications made to this device that are not expressly approved by Philips Consumer Lifestyle may void the user's authority to operate the equipment.



Your product is designed and manufactured with high quality materials and components, which can be recycled and reused.



When this crossed-out wheeled bin symbol is attached to a product it means that the product is covered by the European Directive 2002/96/EC.

Please inform yourself about the local separate collection system for electrical and electronic products.

Please act according to your local rules and do not dispose of your old products with your normal household waste. Correct disposal of your old product helps to prevent potential negative consequences for the environment and human health.



Your product contains batteries covered by the European Directive 2006/66/EC, which cannot be disposed with normal household waste. Please inform yourself about the local

rules on separate collection of batteries because correct disposal helps to prevent negative consequences for the environmental and human health.

Environmental information

All unnecessary packaging has been omitted. We have tried to make the packaging easy to separate into three materials: cardboard (box), paper pulp (buffer) and polyethylene (bags, protective foam sheet.)

Your system consists of materials which can be recycled and reused if disassembled by a specialized company. Please observe the local regulations regarding the disposal of packaging materials, exhausted batteries and old equipment.

This apparatus includes these labels:



Class II equipment symbol



This symbol indicates that the apparatus has a double insulation system.



The making of unauthorized copies of copy-protected material, including computer programs, files, broadcasts and sound recordings, may be an infringement of copyrights and constitute a criminal offence. This equipment should not be used for such purposes.



The USB-IF Logos are trademarks of Universal Serial Bus Implementers Forum, Inc.



Windows Media and the Windows logo are trademarks, or registered trademarks of Microsoft Corporation in the United States and/or other countries.



Note

- The type plate is located on the bottom of the apparatus.



Specifications are subject to change without notice
© 2013 Koninklijke Philips Electronics N.V.
All rights reserved.

AZ783_12_UM_V1.0



Free Manuals Download Website

<http://myh66.com>

<http://usermanuals.us>

<http://www.somanuals.com>

<http://www.4manuals.cc>

<http://www.manual-lib.com>

<http://www.404manual.com>

<http://www.luxmanual.com>

<http://aubethermostatmanual.com>

Golf course search by state

<http://golfingnear.com>

Email search by domain

<http://emailbydomain.com>

Auto manuals search

<http://auto.somanuals.com>

TV manuals search

<http://tv.somanuals.com>