

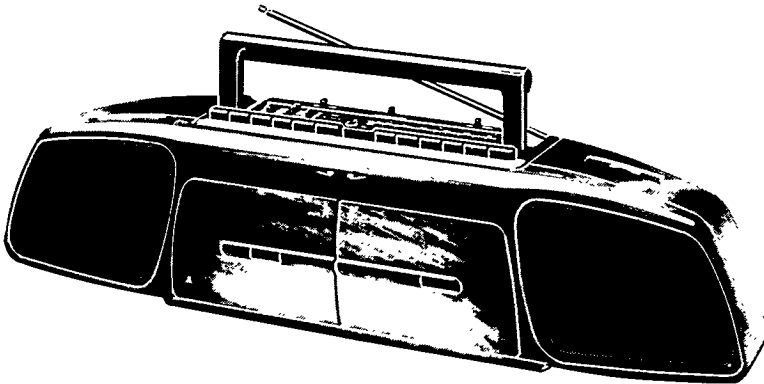

CONSUMER ELECTRONICS

PHILIPS



D 8287 D 8288 D 8289



Stereo Radio Cassette Recorder



Radiocassette stéréo



Stereo-Radio-Cassetten-Recorder



Stereo radio-cassetterecorder



Radiocasete estéreo



Radioregistratore stereo



Stereo kassettradio



Stereo radionauhuri

GB English

page 3

Illustrations
Guarantee and service

page 32
pages 31-33-34

NL Nederlands

pagina 14

Afbeeldingen
Garantie en service

pagina 32
pagina's 31-33-34

F Français

page 6

Illustrations
Garantie et service après-vente

page 32
pages 31-33-34

E Español

página 17

Ilustraciones
Garantía
Es necesario que lea cuidadosamente su instructivo de manejo.

pagina 32
páginas 31-33-34

D Deutsch

Seite 9

Abbildungen
Garantieleistung und Service
Amtsblatt

Seite 32
Seiten 31-33-34
Seiten 2 und 13

I Italiano

pagina 21

Illustrazioni
Garanzia e servizio

pagina 32
pagine 31-33-34

Die Deutsche Bundespost informiert

Sehr geehrter Rundfunkteilnehmer!

Dieses Gerät ist von der Deutschen Bundespost als Ton- bzw. Fernseh-Rundfunkempfänger bzw. als Komponente einer solchen Anlage (Tuner, Verstärker, aktive Lautsprecherbox, Fernseh-Monitor u. dgl.) zugelassen. Es entspricht den zur Zeit geltenden Technischen Vorschriften der Deutschen Bundespost und ist zum Nachweis dafür mit dem Zulassungszeichen der Deutschen Bundespost gekennzeichnet. Bitte überzeugen Sie sich selbst.

Dieses Gerät darf im Rahmen der auf Seite 13 abgedruckten "Allgemeine Genehmigung für Ton und Fernseh-Rundfunkempfänger" in der Bundesrepublik Deutschland betrieben werden.

Beachten Sie aber bitte, daß aufgrund dieser Allgemeinen Genehmigung nur Sendungen des Rundfunks empfangen werden dürfen*). Wer unbefugt andere Sendungen (z.B. des Polizeifunks, des Seefunks, der öffentlichen beweglichen Landfunkdienste) empfängt, verstößt gegen die Genehmigungsaufgaben und macht sich daher nach § 15 Absatz 2a des Gesetzes über Fernmeldeanlagen strafbar.

Die Kennzeichnung mit dem Zulassungszeichen bietet Ihnen die Gewähr, daß dieses Gerät keine anderen Fernmeldeanlagen einschließlich Funkanlagen stört.

Der Zusatzbuchstabe S**) beim Zulassungszeichen besagt außerdem, daß das Gerät gegen störende Beeinflussungen durch andere Funkanlagen (z.B. des Amateurfunks, des CB-Funks) weitgehend unempfindlich ist.

Geräte ohne den Zusatz S sind nicht besonders störfest. Sollten bei Geräten mit dem Zusatz S ausnahmsweise trotzdem Störungen auftreten, oder wenn Sie Fragen haben, so wenden Sie sich bitte an die örtlich zuständige Funkstörungsmeßstelle.

*) Zum Empfang anderer Sendungen darf dieses Gerät nur mit Genehmigung der Deutschen Bundespost benutzt werden. Allgemein genehmigt ist zur Zeit der Empfang der Aussendungen von Amateurfunkstellen und der Normalfrequenz- und Zeitzeichensendungen.

**) Weitere Zusätze haben in Bezug auf die Störfestigkeit keine Bedeutung. Sie geben bei Empfängern vielmehr Aufschluß über Empfangsmöglichkeiten.

03-1987

S Svenska

sida 24

Figurer
Garanti och service

sida 32
sidorna 31-33-34

SF Suomi

sivu 27

Kuvat
Takuu ja huolto

sivu 32
sivut 31-33-34

DK Dansk

Typeskiltet findes på undersiden af apparaten.

Dette produkt overholder kravene til radio-interferens af Europæisk Fællesmarked.

Bemærk: Netafbryderen er sekundært indkoblet og afbryder ikke strømmen fra nettet. Den indbyggede netdel er derfor tilsluttet til lysnettet så længe netstikket sidder i stikkontakten.

Garanti og service sider 31-33-34

N Norsk

Typeskilt finnes på apparatens underside.

Observer: Nettbryteren er sekundært innkopleet. Den innebygde nettdelen er derfor ikke frakopleet nettet så lenge apparatet er tilsluttet nettkontakten.

Garanti og service sider 31-33-34

English



For the illustrations, keep page 32 open

CONTROLS - figs. 1-2

- ① built-in mono microphone MIC
- ② GRAPHIC EQUALIZER tone controls
100 Hz - bass
1 kHz (1 000 Hz) - mid-range
10 kHz (10 000 Hz) - treble
- ③ MODE selector
- ④ socket for stereo headphones
- ⑤ VOLUME control
- ⑥ BAND selector
- ⑦ FM STEREO indicator
- ⑧ TUNING knob
- ⑨ deck A keyboard, for playback only
◀▶ DIRECTION - change the deck A tape direction
□ STOP/EJECT
◀◀ F.FWD - fast forward wind
▶▶ REWIND - fast rewind
◀ PLAY
∞ REVERSE MODE - (released) for non-stop play; (pressed) to play both cassette sides once (◀▶▶STOP)
- ⑩ deck A PLAY DIRECTION indicators
- ⑪ deck B keyboard, recording and playback
■ PAUSE
□ STOP/EJECT
◀◀ F.FWD - fast forward wind
▶▶ REWIND - fast rewind
◀ PLAY
○ RECORD - record
- ⑫ voltage selector (*not on all versions*)
- ⑬ MAINS - socket for mains lead
The type plate is located on the base of the set

SUPPLY

Battery supply

- Open the battery compartment (fig. 2) and insert as indicated six batteries, type R20, UM1 or D-cells.
- Remove the batteries if exhausted or if they will not be used again for a long period.

Note: The battery supply is automatically switched off when the set is connected to the mains. When changing over to battery supply, pull out the plug from the MAINS socket ⑬.

Mains supply

- Check if the mains voltage as shown on the type plate corresponds to your local mains supply. If it does not, consult your dealer or service organisation.
If the set is equipped with a voltage selector ⑫, set this selector to the local mains voltage.
- Connect the mains lead to the MAINS socket ⑬ and the wall socket. The mains supply is now switched on.

- To disconnect the set from the mains completely, withdraw the mains plug from the wall socket.

Important note for users in U.K.:

When fitting a mains plug to the mains lead proceed as follows: The wires in the mains lead are coloured in accordance with the following code: Blue = Neutral, Brown = Live.

These colours may not correspond with the colour markings identifying the terminals in your plug, so proceed as follows: Connect the Brown wire to the terminal marked L or coloured Red. Connect the Blue wire to the terminal marked N or coloured Black. No connection is necessary to the earth terminal.

Note: This apparatus must be protected by a 3 Amp Fuse if a 13 Amp plug is used or, if any other type of plug is used, by a 5 Amp Fuse either in the plug or adapter or at the distribution board. If in doubt consult a qualified electrician.

OPERATION

Switching the power on and off

The set is switched on and off with MODE selector ③. The set is switched off when MODE selector ③ is in position TAPE or MIC (1, 2 or 3) and the recorder buttons are released.

MODE selector ③

The desired sound source for reproduction or recording is selected using MODE selector ③.

Radio and cassette playback

Set the MODE selector ③ to:

4 RADIO ON for switching on the radio;

1, 2 or 3 RADIO OFF for switching off the radio;

1 or 2 TAPE for cassette playback:

- on deck A:

∞ released for non-stop playback;

∞ pressed to play both cassette sides once:

PLAY ◀▶▶STOP;

- on deck B: PLAY ◀▶STOP;

- on deck A + B, continuous play: play both cassette sides in deck A (◀▶) and at the end of the cassette deck B will automatically start playing (◀▶▶STOP).

Recording and dubbing

Set the MODE selector ③ to:

1 HIGH SPEED DUBBING for high speed copying from deck A to B;

2 NORMAL SPEED DUBBING for normal speed copying from deck A to B;

3 MICROPHONE for a mono recording on deck B from the built-in microphone MIC ① (set the VOLUME control ⑤ to zero);

4 RADIO ON for a radio recording on deck B.

Sound adjustment

The sound reproduced by the loudspeakers or by stereo headphones is adjusted by means of the controls VOLUME ⑤ and GRAPHIC EQUALIZER ②. The position of these controls does not affect the recording.

- The VOLUME control ⑤ enables adjustment of the sound volume.

● The GRAPHIC EQUALIZER ② consists of several tone controls, each controlling its own pitch range. The three controls are centered on 100 Hz (bass), 1 kHz (1 000 Hz, mid-range) and 10 kHz (10 000 Hz, treble).

RADIO

Radio reception

- Set MODE selector ③ to [4] **RADIO ON**.
- Set the BAND selector ⑥ to the desired wave-band.
- Adjust the sound with the controls VOLUME ⑤ and GRAPHIC EQUALIZER ②.

You may connect stereo headphones with 3.5 mm plug to socket ④ . The loudspeakers are then muted.

- Tune to a radio station using TUNING knob ⑧.

(*SW and LW not on all versions*).

- For FM-reception, pull out the telescopic aerial. To improve FM-reception, incline and turn the aerial. Reduce its length if the FM-signal is too strong (very close to a transmitter).

- For AM/MW and LW reception (Medium and Long Wave), the set is provided with a built-in ferrite aerial. To improve AM-reception, turn the whole set.

- For Short Wave (SW) reception, the telescopic aerial must be pulled out and placed in the vertical position. To improve SW-reception, vary the length of the aerial.

- When the set is in position FM STEREO and the FM STEREO indicator ⑦ lights up, you are receiving a FM-stereo transmitter. A disturbing noise, due to a weak FM-stereo signal, can be suppressed by switching the set to FM MONO. The FM STEREO indicator ⑦ will then go out and you will hear (*and record*) the FM programme in mono.

- To switch off the set, place MODE selector ③ to position TAPE or MIC (1, 2 or 3).

CASSETTE RECORDER

Copyright

Recording is permissible insofar as copyright or other rights of third parties are not infringed.

For U.K. only: Recording and Playback of material may require consent. See Copyright Act 1956 and The Performer's Protection Acts 1958 to 1972.

Compact cassettes

For *recording*, use only NORMAL or FERRO cassettes (ferric oxide, IEC type I).

For *playback*, any cassette type can be inserted.

Fast winding and rewinding

Press fast forward wind F.FWD ◀ or REWIND ▶▶ button.

To stop fast winding, press STOP button □.

Safeguard against accidental erasure

To protect a recording e.g. on side 1 of the cassette, break out the tab as shown in fig. 4. Now, recording on side 1 is no longer possible.

You can render this safeguard ineffective by covering the aperture now existing with a piece of adhesive tape.

RECORDING

Recording on deck B

- Set MODE selector ③ to:

[4] **RADIO ON** for a radio recording;

[3] **MICROPHONE** for a mono recording from the built-in microphone MIC ① (set the VOLUME control ⑤ to zero).

For copying from deck A to deck B, see chapter 'DUBBING'.

Important: During recording, the deck A buttons should not be pressed (except for PLAY ◀ during dubbing).

- In case of FM radio recordings, switch the set to the desired position (FM MONO or FM STEREO).

- Press EJECT □ to open the cassette holder.

- Insert the cassette into deck B (fig. 3). For recording you must use a cassette on which the tabs on the back (fig. 4) *are not broken out*.

For *recording*, use only NORMAL or FERRO cassettes (ferric oxide, IEC type I).

For *playback*, any cassette type can be inserted.

- Now start recording by pressing RECORD ○; in doing so, PLAY ◀ is automatically pressed too.

At the very beginning of the tape, no recording will take place during the first 7 seconds when the transparent leader tape passes the recorder heads.

The automatic recording level control ensures that all sounds are recorded at the correct level.

- When monitoring during recording, adjust the sound with the controls VOLUME ⑤ and GRAPHIC EQUALIZER ②. These controls do not affect the recording.

During microphone recordings, monitoring is not possible (set the VOLUME control ⑤ to zero).

- For brief interruptions, press PAUSE ⏸. To restart recording, press this button once more.

- To stop recording, press STOP □. On pressing again, the cassette holder will open.

- When the end of the tape is reached, the pressed deck B buttons will automatically be released.

- The set is switched off if MODE selector ③ is in position TAPE or MIC (1, 2 or 3) and the recorder buttons are not pressed.

DUBBING - Copying from deck A to deck B

- When copying, it is recommended to use fresh batteries or to connect the set to the mains.

- During dubbing, the deck A buttons should not be pressed (except for PLAY ◀).

- Set MODE selector ③ to:

[1] **HIGH SPEED DUBBING** for high speed copying;

[2] **NORMAL SPEED DUBBING** for normal speed copying.

Note: Do not switch this selector *during* dubbing.

- Press both EJECT buttons □ and insert a recorded cassette into deck A and a cassette which is suited for recording into deck B (fig. 3).

For *recording*, use only NORMAL or FERRO cassettes (ferric oxide, IEC type I).

- Set the deck A REVERSE MODE button ↔ to:
■ (released) for non-stop playback;

- (pressed) to play both cassette sides once:
 - ◀▶▶STOP.
- Deck A will start in play direction ◀. Press DIRECTION ◀▶ if you want to copy the other side of the cassette.
- Dubbing will start by pressing at the same time the buttons PLAY ◀ on deck A and RECORD ○ on deck B.
- For synchronised dubbing, press on deck B first PAUSE ⏸ and then RECORD ○. As soon as you press on deck A the PLAY button ◀, both decks will start simultaneously.
- Dubbing will continue also if the deck A play direction is reversed (automatically or by hand using DIRECTION button ◀▶).
- By pressing the deck B PAUSE button ⏸, you can omit undesired passages while deck A continues, or you can insert another cassette in deck A and search for a particular passage on it. To restart copying, press PAUSE ⏸ once more.
- Using the STOP button □ of deck A, deck B will record a blank part.
- To stop dubbing, press both STOP buttons □. The set is then switched off.
- When the end of the tape in deck B is reached, the deck B buttons are automatically released.

CASSETTE PLAYBACK

- **Reverse on deck A**
- Set the REVERSE MODE button ∞ to:
 - (released) for non-stop playback: deck A automatically reverses the play direction whenever reaching the end of the cassette;
 - (pressed) to play both cassette sides once:
 - ◀▶▶STOP. So, deck A starts in play direction ◀, reverses at the end the play direction to ▶ and, when reaching the end again, it stops and releases the PLAY button.
- The deck A play direction is shown by the PLAY DIRECTION indicators Ⓢ.
- Deck A will start in play direction ◀, however, you can reverse the play direction at any moment by pressing DIRECTION ◀▶.

Cassette playback on deck A or B

- Set MODE selector Ⓢ to 1 or 2 TAPE.
 - Press EJECT □ and insert a recorded cassette (fig. 3).
 - Press PLAY ◀ and playback will start.
 - Adjust the sound with the controls VOLUME Ⓢ and GRAPHIC EQUALIZER Ⓢ.
- You may connect stereo headphones with 3.5 mm plug to socket ④ Ⓢ. The loudspeakers are then muted.
- During playback, the tape in the other deck **should not** be fast forward wound or rewound, otherwise the actual cassette playback is affected.
 - When the end of the tape is reached, the recorder buttons are automatically released (except for non-stop play on deck A).
 - To stop playback, press STOP □. The set is then switched off.

Continuous play on deck A+B

- Set MODE selector Ⓢ to 1 or 2 TAPE.
- Press both EJECT buttons □ and insert a recorded cassette into both decks (fig. 3).
- Set the deck A REVERSE MODE button ∞ to – (pressed) to play both cassette sides once.
- Press the deck A button PLAY ◀ and playback will start.
- After that, press the deck B buttons PAUSE ⏸ and PLAY ◀.
- As soon as deck A stops (at the end of play direction ▶ or when the STOP button □ is pressed), deck B will start playing back.
- To stop playback, press STOP □. The set is then switched off.

MAINTENANCE

Maintenance

- Clean the parts indicated in fig. 5 after every 50 hours of operation or, on average, once a month.
 - Open the cassette holder by pressing EJECT □.
 - Use a cotton bud slightly moistened with alcohol or a special head cleaning fluid.
 - Press PLAY ◀ and clean the rubber pressure roller Ⓐ (fig. 5).
 - Then press PAUSE ⏸ and clean the capstan Ⓢ, recording/playback head Ⓢ and erase head Ⓢ.
 - After cleaning, press STOP □.
- Cleaning of the heads Ⓢ and Ⓢ can also be done by playing the cleaning cassette SBC 114 through once as an ordinary cassette.
- The recorder-mechanisms are fitted with self-lubricating bearings and therefore must not be oiled or greased.
 - Do not expose the set, batteries or cassettes to rain or moisture, or, for any great length of time, to excessive heat from heating equipment or direct sunshine, e.g. in motor cars parked in the sun.
 - Keep the set and the cassettes away from sand and do not store the cassettes too close to magnets, loudspeakers or transformers.
 - Fingerprints, dust and dirt on the apparatus can be removed using a soft and clean, slightly damp leather cloth. Do not use any cleaning agents which contain abrasives or solvents such as benzine thinner, alcohol, refined petrol or ammonia, since they may affect and harm the cabinet.

This product complies with the radio interference requirements of the European Community.

GUARANTEE AND SERVICE FOR UNITED KINGDOM

Philips sell this product subject to the understanding that if any defect in manufacture or material shall appear in it within 12 months from the date of consumer sale, the dealer from whom the product was purchased will arrange for such defect to be rectified without charge, provided:

1. Reasonable evidence is supplied that the product was purchased within 12 months prior to the date of claim.

2. The defect is not due to use of the product for other than domestic purposes, or on an incorrect voltage, or contrary to the Company's operating instructions, or to accidental damage (whether in transit or otherwise), misuse, neglect or inexpert repair.

Products sent for service should be adequately packed as no liability can be accepted for damage or loss in transit, and name and address must be enclosed.

Facts about free service

When service is required, apply to the dealer from whom the product was purchased. Should any difficulty be experienced in obtaining Service, e.g. in the event of the dealer having ceased to trade, you are advised to contact Philips Service.

These statements do not affect the statutory rights of a consumer

If you have any questions which your dealer cannot answer, please write to **Philips Consumer Relations,**

☐ P.O. Box 298, 420 London Road, CROYDON CR9 3QR,
or ☎ (01) 689-2166 Consumer Advice.

Please retain this card. Produce if service is required.

GUARANTEE AND SERVICE VALID FOR IRELAND

This apparatus is made of high quality material and great care has been taken in its manufacture.

Philips, therefore, give you a guarantee on parts against failures arising from faulty workmanship or material for 12 months after date of purchase. This guarantee is valid on the condition that this certificate is completed and signed immediately on delivery of the apparatus. In case of failure ask your dealer for further information. If you have any questions which your dealer cannot answer, you may apply to **Philips Electrical (Ireland) Ltd., Service Department, Newstead, Clonskeagh, DUBLIN 14 - ☎ 69 33 55**

GUARANTEE AND SERVICE VALID FOR AUSTRALIA

(Audio other than Car Radio)

The benefits given to the purchaser by this warranty are in addition to all other rights and remedies, which, under the Trade Practices Act or other Commonwealth or State law, the purchaser or owner has in respect of the product.

The Philips product carries the following warranties:

Compact Disc Players: 12 months.

Home Audio Systems: 6 months.

Clock radios, portable radios, cassette recorders, cassette players and radio recorders: 90 days.

Any defect in materials or workmanship occurring within the specified period from the date of delivery, will be rectified free of charge by the retailer from whom this product was purchased.

Note: Please retain your purchase docket to assist prompt service.

Conditions of this warranty

1. All claims for warranty service must be made to the retailer from whom this product was purchased. All transport charges incurred in connection with warranty service or replacement will be paid by the purchaser.

2. These warranties do not cover batteries and extend only to defects in materials or workmanship occurring under normal use of the product where operated in accordance with our instructions.

Philips Consumer Products Division, Technology Park, Figtree Drive, Australia Centre, HOMEBUSH 2140, New South Wales

GUARANTEE AND SERVICE FOR NEW ZEALAND

Thank-you for purchasing this quality Philips product. The document you are now reading is your guarantee card.

Guarantee.

Philips New Zealand Ltd guarantees this product against defective components and faulty workmanship for a period of **12 months** from the date you bought it. If the product breaks down during the guarantee period, Philips shall - subject to the following conditions - repair or replace the product **at no charge to you**. This includes costs for labour, parts, and cartage.

Conditions

1. The product must have been purchased in New Zealand, and this guarantee card completed at time of purchase (this is your proof of the date of purchase).

2. The guarantee applies only to faults caused by defective components, or faulty workmanship on the part of the manufacturer.

3. The guarantee does not cover failures caused by misuse, neglect, normal wear and tear, accidental breakage, use on the incorrect

voltage, use contrary to operating instructions, or unauthorised modification to the product or repair by an unauthorised technician.

4. Reasonable evidence (in the form of a sales docket or completed guarantee card) must be supplied to indicate that the product was purchased no more than 12 months prior to the date of your claim.

5. In the event of a failure, Philips shall be under no liability for any injury, or any loss or damage caused to property or products other than the product under guarantee.

This guarantee does not prejudice your rights under common law and statute, and is in addition to the normal responsibilities of the retailer and Philips.

How to claim.

Should your Philips product fail within the guarantee period, please return it to the retailer from whom it was purchased. In most cases the retailer will be able to satisfactorily repair or replace the product.

However, should the retailer not be able to conclude the matter satisfactorily, or if you have other difficulties claiming under this guarantee, please contact:

**The Guarantee Controller, Philips New Zealand Ltd,
☐ P.O. Box 1041, AUCKLAND - ☎ (09) 605-914**

GARANTIE ET SERVICE APRÈS-VENTE EN FRANCE

Cet appareil a été fabriqué avec le souci de vous donner entière satisfaction. PHILIPS fournira gratuitement au vendeur les pièces détachées nécessaires à sa réparation pendant les périodes suivantes, chacune prenant effet à compter de la date de vente:

- 6 mois pour les magnétophones à cassettes portatifs, les récepteurs radio portatifs, les radiocassettes, les radio-réveils et les électrophones;

- 12 mois pour les radiocassettes équipées de la fonction Compact Disc et les baladeurs Compact Disc;

- 12 mois pour les récepteurs radio destinés à être installés à poste fixe dans un véhicule automobile;

- 12 mois pour les appareils entrant dans la composition d'une chaîne électro-acoustique, y compris les chaînes compactes stationnaires équipées d'au moins deux sources sonores; sauf si la détérioration résulte d'une cause étrangère à l'appareil ou du non respect des prescriptions d'utilisation.

Vous bénéficierez en tout état de cause des dispositions des art. 1641 et suivants du Code Civil relatifs à la garantie légale. Pour tout conseil ou intervention, adressez-vous à votre vendeur. Pour tout renseignement complémentaire, vous pouvez vous adresser à la succursale Philips la plus proche.

Soucieux d'améliorer continuellement la qualité de nos produits, nous nous réservons le droit d'en modifier à tout moment les caractéristiques.

PHILIPS Électronique Domestique - Société en nom collectif

RCS NANTERRE B 333 760 833

64, Rue Carnot - ☐ B.P. 306

92 156 SURESNES Cédex

Informations Consommateurs: ☎ (1) 42 04 25 60

GARANTIE EN BELGIQUE ET LUXEMBOURG

Pour les conditions de garantie en Belgique et Luxembourg veuillez vous référer à la carte de garantie que le revendeur doit vous remettre au moment de l'achat.

● Pour la Belgique

Si après l'achat de l'un ou l'autre appareil Philips vous avez des problèmes concernant par exemple la garantie, le fonctionnement ou l'utilisation de ces appareils et que le distributeur qui vous a vendu ces appareils éprouve des difficultés pour les résoudre, prenez contact, soit par téléphone, soit par écrit avec notre service

'Contact Clientèle', Place de Brouckère 2, 1000 - BRUXELLES

☎ 02/211 91 11

GARANTIE EN SERVICE EN BELGIË EN LUXEMBURG

In België en Luxemburg gelden uitsluitend de garantiebepalingen zoals die in het via uw-handelaar apart verstrekte garantiebewijs staan aangegeven.

● Voor België

Indien u na de aankoop van een of ander Philips apparaat problemen heeft met bijv. de werking, of het gebruik ervan, en indien de verdeler die u deze apparaten verkocht heeft moeilijkheden ondervindt om deze problemen op te lossen, stelt u zich dan telefonisch of schriftelijk in verbinding met onze dienst

'Klanten Kontakt', de Brouckèreplein 2, 1000 - BRUSSEL

☎ 02/211 91 11

GARANTIE EN SERVICE IN NEDERLAND

● Wat wordt gegarandeerd?

Philips Nederland garandeert dat dit apparaat kosteloos wordt hersteld indien - bij normaal particulier gebruik volgens de gebruiksaanwijzing - binnen zes maanden na aankoopdatum fabricage- en/of materiaalfouten optreden.

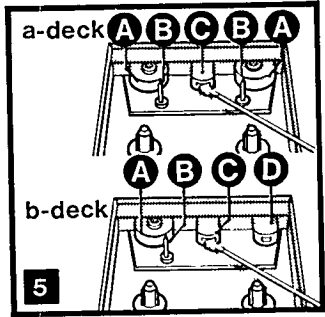
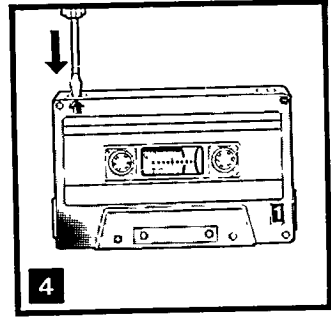
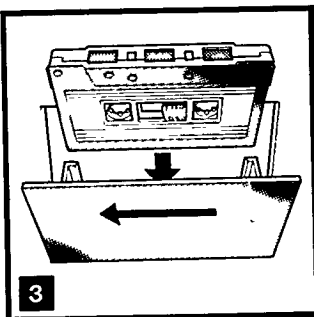
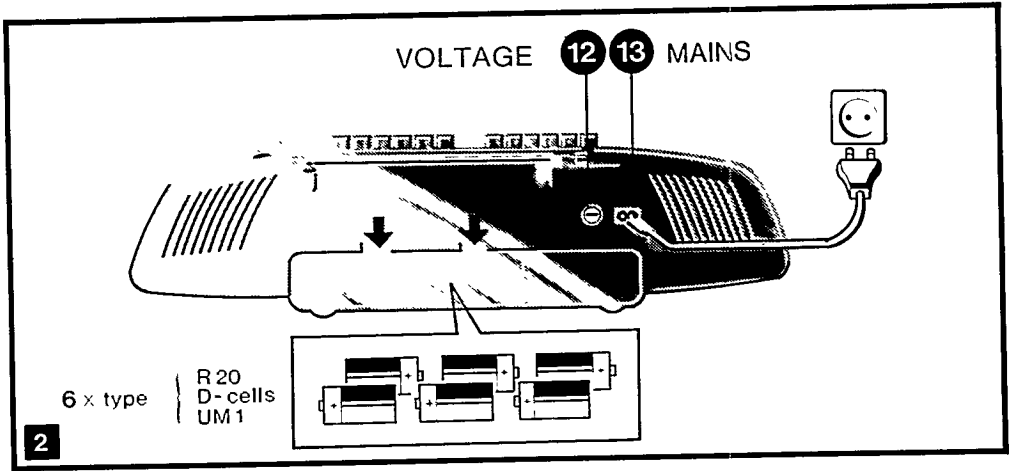
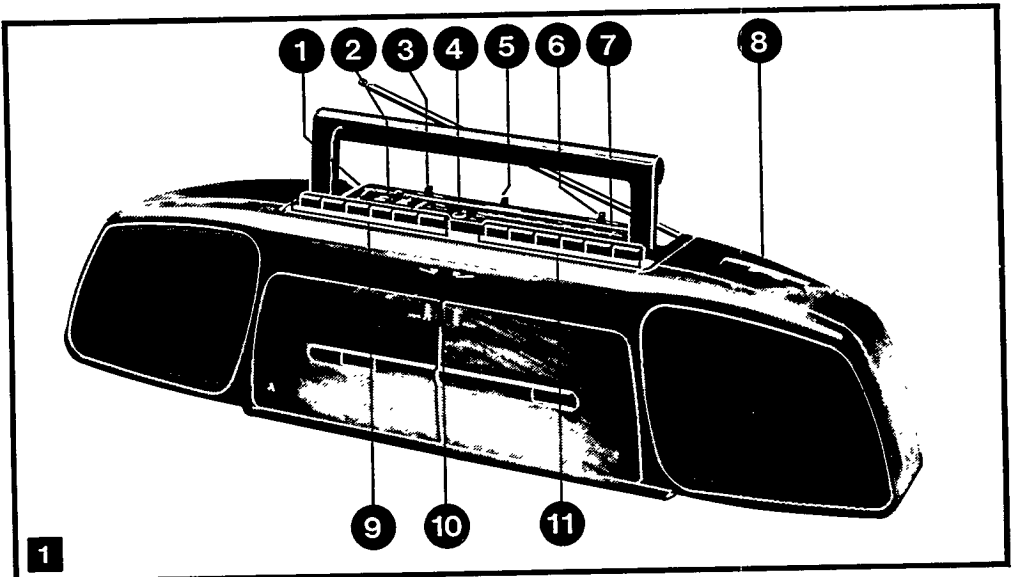

● **Wie voert de garantie uit?**

De zorg voor de uitvoering van de garantie berust bij de handelaar die u het apparaat verkocht heeft. De handelaar kan daarbij eventueel een beroep doen op een der Philips Technische Service Centra.

● **Uw aankoopbon + de identificatiekaart**

De identificatiekaart is uw garantiebewijs. U kunt alleen een beroep doen op de bovenomschreven garantie tegen overlegging van de aankoopbon (factuur, kassabon of kwitantie), in combinatie met de identificatiekaart, waarop typenummer en serienummer zijn vermeld. Uit de aankoopbon dienen duidelijk de aankoopdatum en de naam van de handelaar te blijken. Mocht het noodzakelijk zijn deze documenten aan uw handelaar af te geven, dan kunt u hem daarvoor een ontvangstbewijs vragen.

De garantie vervalt indien op de genoemde documenten iets is veranderd, doorgehaald, verwijderd of onleesbaar gemaakt. De garantie vervalt eveneens indien het typenummer en/of serienummer op het apparaat is veranderd, doorgehaald, verwijderd of onleesbaar gemaakt.

● **Hoe te handelen bij een storing?**

Om onnodige kosten te voorkomen, raden wij u aan bij storingen eerst nauwkeurig de gebruiksaanwijzing te lezen. Indien de gebruiksaanwijzing daarin geen uitkomst biedt, kunt u uw handelaar raadplegen en/of hem het apparaat ter reparatie in de werkplaats aanbieden.

● **...en bij problemen?**

Bij problemen omtrent de garantie-uitvoering kunt u zich in verbanding stellen met **Philips Nederland, Afdeling Consumentenbelangen, Antwoordnummer 500 - 5600 VB EINDHOVEN** (postzegel niet nodig), of ☎ **040-78 11 78**.

GARANTIE FÜR DIE BUNDESREPUBLIK DEUTSCHLAND UND WEST-BERLIN

Philips-Geräte sind Markenartikel, die mit größter Präzision nach modernsten Fertigungsmethoden und mit einem Höchstmaß an Sorgfalt hergestellt werden. Das Gerät wird Ihnen gute Dienste leisten, vorausgesetzt daß Sie es sachgemäß bedienen und unterhalten.

Trotz aller Sorgfalt ist das Auftreten von Fehlern nicht auszuschließen. Ihr Partner für die Behebung derartiger Fehler ist Ihr Fachhändler, bei dem das Gerät erworben wurde. Falls ein Reklamationsfall eintritt, wenden Sie sich bitte unter Vorlage des Einkaufsbeleges und dieses Gerätepasses an Ihren Fachhändler.

GARANTIE FÜR DIE SCHWEIZ

Philips-Geräte sind aus einwandfreiem Material und mit großer Sorgfalt hergestellt worden. Dieses Gerät wird Ihnen gute Dienste leisten, sofern es sachgemäß bedient und unterhalten wird.

Trotz aller Sorgfalt ist das Auftreten von Fehlern nicht ganz auszuschließen. Im Falle eines Defektes wenden Sie sich bitte unter Vorlage des Einkaufsbeleges und dieses Gerätepasses an das Fachgeschäft, in welchem Sie das Gerät erworben haben.

GARANTIE POUR LA SUISSE

Les appareils Philips ont été fabriqués au moyen de matériaux de toute première qualité et avec beaucoup de soins. Cet appareil vous donnera encore plus de satisfaction si l'utilisation et l'entretien sont suivis selon le mode d'emploi.

Malgré tous les soins apportés, l'apparition de défauts n'est pas exclue. Dans ce cas, nous vous serons reconnaissants de bien vouloir vous adresser directement chez votre vendeur muni du passeport de l'appareil ainsi que de la facture s'y reportant.

GARANTIA PER LA SVIZZERA

Gli apparecchi Philips sono prodotti con materiali di prima qualità e assemblati con la massima cura. Essi Vi offronno un ottimo servizio, in cambio di un accurato uso e manutenzione.

Malgrado tutti i nostri sforzi, non è escluso che possano avvenire dei guasti. In caso di difetto Vi preghiamo di rivolgerVi al Vostro fornitore specializzato, portando con Voi questo passaporto assieme ai documenti d'acquisto.

GARANTIE IN ÖSTERREICH

Die Österreichische Philips Industrie Gesellschaft m.b.H. unterstützt die gesetzlichen Gewährleistungsverpflichtungen Ihres Händlers durch folgende Garantieusage:

1. Dieses Gerät (siehe Typenschild) wird innerhalb von 6 Monaten ab Verkaufsdatum bei Auftreten eines Funktionsmangels (Fabrikations- oder Materialfehlers) in einer unserer Service-Filialen kostenlos, d.h. ohne Berechnung von Material und Arbeitszeit, repariert.

2. Die Garantieusage betrifft nur Neugeräte, die über die Österreichische Philips Industrie Gesellschaft m.b.H. und ihre Vertragspartner in Österreich verkauft wurden. Sie gilt für folgende Arten: Autoradios, Cassetten-Recorder, Compact Disc Spieler,

HiFi-Bausteine, HiFi-Kombinationen, MusiClocks, Plattenspieler, Radio-Recorder und das mitgelieferte Originalzubehör dieser Geräte.

3. Zur Inanspruchnahme einer Garantiereparatur gemäß der vorliegenden Zusage sind dieser Garantieschein und die Originalrechnung mit Kaufdatum vorzulegen.

4. Anstelle einer kostenlosen Garantiereparatur behalten wir uns vor, das defekte Gerät gegebenenfalls gegen ein Neues auszutauschen.

5. Schäden, die durch äußere Einflüsse, unsachgemäße Behandlung oder unsachgemäßen Fremdlingriff entstanden sind, sowie Gehäusefehler oder Glasbruch sind von dieser Garantieusage ausgeschlossen.

Philips Zentrale Kundeninformatoren:

- 1101 WIEN, Triesterstraße 64, ☎ 0222-60101-DW 1620 oder DW 1563
- 6020 INNSBRUCK, Klostergasse 4, ☎ 05222-74694
- 9020 KLAGENFURT, Villacher Straße 161, ☎ 0463-22397-DW 94

Philips Service-Organisation:

- 1232 WIEN, Ketzergasse 120, ☎ 0222-8662-0

GARANZIA E ASSISTENZA VALIDA PER L'ITALIA

Questo apparecchio è stato realizzato con materiali di prima qualità e costruito con la massima cura. La Philips comunque fornisce all'acquirente una Garanzia di buon funzionamento secondo le condizioni stabilite dall'ANIE.

Tale Garanzia decorre dalla data di acquisto ed ha la durata di **6 mesi**. Per aver diritto alla Garanzia è necessario che questo certificato riporti i dati di Modello e Matricola dell'apparecchio, la data di acquisto ed il timbro del rivenditore; inoltre per tutti gli apparecchi per i quali è prevista la "ricevuta fiscale" (o altro documento di consegna) il documento stesso dovrà essere conservato con questo certificato a certificazione della data d'acquisto.

In caso di necessità il prodotto dovrà essere fatto pervenire al Centro di Assistenza più vicino il cui recapito è pubblicato sugli elenchi telefonici della zona di residenza alla voce Philips.

Per questo apparecchio Philips offre un Abbonamento all'Assistenza Tecnica. Per informazioni rivolgersi ai Centri di Assistenza o al servizio Consumatori Philips.

Philips S.p.A., Viale le Fulvio Testi 327, 20162 MILANO

☎ 1678-20026

PHILIPS IBÉRICA, S.A.E.

Garantiza este aparato durante 6 meses, a partir de la fecha de adquisición, de la forma siguiente:

1. Cubriendo cualquier defecto de fabricación o vicio de origen, así como la totalidad de sus componentes, incluyendo la mano de obra necesaria para el reemplazo de las piezas defectuosas, por nuestros talleres autorizados.

2. Esta garantía no cubrirá la avería, si es consecuencia de incorrecta instalación del aparato, manifiesto mal trato o uso inadecuado del mismo.

La calificación de las averías corresponderá únicamente a los servicios técnicos de los talleres autorizados Philips.

3. Las reparaciones que pudieran producirse durante el período de vigencia de la presente garantía se efectuarán, bien en el domicilio del usuario, bien en los talleres autorizados Philips, a libre elección y criterio de ésta última.

4. Transcurrido un mes desde la fecha de adquisición del aparato, todos los gastos de desplazamiento del personal técnico para proceder al examen y/o reparación del aparato correrán por cuenta del usuario de acuerdo con las tarifas establecidas para este concepto.

5. En todas las reparaciones se deberá acompañar al aparato factura de compra y la presente garantía debidamente cumplimentada, con la indicación exacta de la fecha de venta del aparato.

6. En todo caso, el titular de la garantía tiene los derechos mínimos reconocidos por la Ley.

Titular (Comprador)

Domicilio

GARANTÍA PARA MÉXICO

Este aparato está fabricado con materiales de alta calidad y ha sido cuidadosamente montado.

Philips, por lo tanto, da a usted una garantía a partir de su fecha de compra.

- 12 meses para: Equipos Modulares y Reproductores de discos compactos.

- 6 meses para: Amplificadores, Sintonizadores, Sinto Amplificadores, Decks de Cassettes, Magneto-fonos, Ecualizadores, Tomemas, Cajas Acústicas, Radios Combinados y Auto Radios.

- 3 meses para: Radio portátil y de mesa, Radio Reloj, Altavoces, Deck de Cassette portátil. Teléfono y Radio Teléfono.

La garantía ampara la reposición de las piezas defectuosas debidas a un fallo en su montaje o en los materiales, incluyendo la mano de obra necesaria para su reemplazo en nuestras sucursales o talleres autorizados, rogamos se ponga usted en contacto con su distribuidor.

Esta garantía no cubrirá la avería, si es consecuencia de una instalación incorrecta del aparato, manifiesto mal trato y uso inadecuado del mismo.

Philips se obliga a reparar y devolver a usted su aparato en un plazo no mayor de 30 días hábiles contados a partir de la fecha de haber ingresado su aparato a uno de nuestros talleres.

Para que esta garantía sea válida, es necesario que el certificado en la parte posterior de este libro le sea debidamente llenado en el momento de la compra del aparato.

En caso de extravío de la garantía, con la presentación de su factura o remisión podrá hacer efectiva la garantía correspondiente.

Si usted tiene alguna duda o pregunta que no le pueda solucionar su distribuidor, por favor ponerse en contacto con:

Oficina Central de Servicio
Av. Coyacán No. 1051 Col. del Valle
03100 MÉXICO, D.F. - ☎ 575-2022 o 575-0100

CONDIÇÕES VÁLIDAS PARA PORTUGAL

A Philips Portuguesa, SA, assegura ao comprador deste aparelho garantia contra qualquer defeito de material ou fabrico, pelo prazo de 6 meses, contado a partir da data de aquisição. As agulhas de fonocaptores não têm qualquer garantia.

A Philips Portuguesa, SA, anula a garantia ao aparelho desde que se verifique ser a deficiência motivada por acidente, utilização incorrecta, causas externas, ou nos casos em que apresente vestígios de ter sido violado, ajustado ou reparado por entidade não autorizada. Também será considerada nula a garantia se este certificado apresentar rasuras ou alterações.

A Philips Portuguesa, SA, obriga-se a prestar a garantia refenda somente nos seus Serviços Técnicos ou nos Concessionários de Serviço autorizados. As despesas e riscos de transporte de e para as oficinas serão sempre da responsabilidade do comprador.

Nota: Para que o aparelho seja assistido ao abngo da garantia, é indispensável que seja apresentado este certificado, devidamente preenchido e autenticado, por vendedor autorizado, aquando da sua aquisição.

Se sobre esta garantia necessitar algum esclarecimento que o vendedor não lhe possa dar, deve dirigir-se a:

Philips Portuguesa, SA,
- Outurela - Camaxide - 2795 LINDA A VELHA - ☎ 218 00 71/9
- R. Eng. Ezequiel de Campos, 182 - 4100 PORTO - ☎ 67 26 13

GARANTI OG SERVICE FOR DANMARK

De er nu ejer af et apparat, hvis konstruktion er baseret på erfaring og lang tids forskning.

Philips garanterer for kvaliteten, og hvert led i fabrikationen er underkastet stadig kontrol. Alle henvendelser om fejl under garantien skal rettes til den forhandler, der har udleveret og underskrevet garantibeviset, hvorpå de gældende garantibestemmelser tillige er anført. Garantien er kun gældende i kobslandet.

GARANTI I NORGE

De er nå eier av et apparat som er basert på lang tids forskning og erfaring.

Philips garanterer for kvaliteten, men hvis en feil skulle oppstå bes De ta kontakt med den forhandler som har utlevert og underskrevet garantibeviset. Garantien gjelder kun i kjøpslandet hvor de gjeldende garantibestemmelser må følges.

Hvis De trenger ytterligere opplysninger utover de forhandleren kan gi Dem, kan De henvende Dem til: **Norsk A/S Philips, Avd. Audio/Video, Sandstuveien 70, OSLO 6 - ☎ 02 - 68 02 00.**

GARANTI I SVERIGE

Garanti lämnas på denna Philipsapparat i enlighet med den garantiförbindelse som tillhandahålles av återförsäljaren. I garantiförbindelsen ges anvisningar om reklamation. Garantien gäller endast i inköpslandet.

TAKUU JA HUOLTO

Taman tuotteen rakenne on pitkäaikaisen, kokemuksella tehdyin tutkimustyon tulos. Jatkuvan en tuotantovaiheissa tehtävän laatutarkkailun vuoksi Philips takaa tuotteen sa laadun.

Tarkemmat tiedot takuuehdoista saat Philips-myyjältä tai alla olevasta osoitteesta.

☎ **Philips AB, Sinikalliontie 3, 02630 ESPOO - ☎ (358-0)-50261**
 ☎ **Philips AB, P.O. Box 75, 02631 ESPOO**

ΠΛΗΡΟΦΟΡΙΕΣ ΓΙΑ SERVICE ΚΑΙ ΕΓΓΥΗΘΗ ΣΤΗΝ ΕΛΛΑΔΑ

Η συσκευή έχει ελεγχθεί σχολαστικά, η λειτουργία της είναι άριστη και λόγω αντικαταστάσεώς της δεν πρόκειται σε καμμία περίπτωση να προκύψει. Αν όμως, παρ όλα αυτά, κάποιο εξάρτημα δεν λειτουργήσει, το εξάρτημα αυτό και η εργασία επισκευής παρέχονται δωρεάν από την Εταιρεία. Η προσκομιζόμενη για επισκευή συσκευή πρέπει απαραιτήτως να συνοδεύεται από το παρόν έντυπο υπογεγραμμένο και σφραγισμένο από το κατάστημα όπου αγοράστηκε η συσκευή και με την ημερομηνία αγοράς.

Η εγγύηση ισχύει για 1 έτος από την ημερομηνία αγοράς. Η εγγύηση δεν ισχύει στις παρακάτω περιπτώσεις:

- α) Για ανωμαλία όχι από βλάβη της συσκευής, αλλά από φθορά ή βλάβη, που προέκυψε από τρίτους ή από μεταβολή της τάσεως του ηλεκτρικού ρεύματος.
- β) Για ανωμαλία λόγω ελαττωματικής εγκαταστάσεώς της συσκευής.
- γ) Όταν ο αριθμός κατασκευής της συσκευής έχει αλλοιωθεί.
- δ) Για κεραμίες πινακίτι και μικρόφωνο.

Η εργασία επισκευής γίνεται στα Εργαστήρια της Εταιρείας, όπου ο πελάτης πρέπει να μεταφέρει τη συσκευή με δική του δαπάνη.

Κανένας αντιπρόσωπος δεν έχει το δικαίωμα αλλαγής των όρων εγγυήσεως.

Μετά τη λήξη του χρόνου εγγυήσεως, για κάθε πρόβλημα συντηρήσεως, επισκευής ή συμβουλής, σας συστήνουμε να απευθυνθείτε στα κατά τόπους SERVICE της Εταιρείας.

Διεύθυνση Κεντρικών SERVICE PHILIPS:
 25ης Μαρτίου 15, 177 78 Τεύρος - ☎ 4894 911
 Ταχυμηνή 62, 546 93 Θεσσαλονίκη - ☎ 260.621

Guarantee certificate
Garantieschein
Certificado de garantía
Certificado de garantia
Takuutodistus

Certificat de garantie
Identificatiekaart
Certificado di garanzia
Garantibeviset
 Εγγύηση

Type no. of product:

Tipo no. del producto:

Date of purchase	-	Date d'achat	-	Kaufdatum
Koopdatum	-	Fecha de compra	-	Data da compra
Data di acquisto	-	Kobsdato	-	Kjøpedato
Inkopsdato	-	Ostopäivä	-	Ημερομηνία αγοράς

19

Dealer's name, address and signature
 Nom, adresse et signature du revendeur
 Name, Anschrift und Unterschrift des Handlers
 Naam, adres en handtekening van de handelaar
 Nombre, dirección y firma del distribuidor
 Nome, indirizzo e firma del fornitore
 Nome, morada e assinatura do vendedor
 Forhandlerens navn, adresse og underskrift
 Återförsäljarens namn, adress och namnteckning
 Myyjän nimi, osoite ja allekirjoitus
 Όνομα/Επώνυμο Αντιπροσώπου

Free Manuals Download Website

<http://myh66.com>

<http://usermanuals.us>

<http://www.somanuals.com>

<http://www.4manuals.cc>

<http://www.manual-lib.com>

<http://www.404manual.com>

<http://www.luxmanual.com>

<http://aubethermostatmanual.com>

Golf course search by state

<http://golfingnear.com>

Email search by domain

<http://emailbydomain.com>

Auto manuals search

<http://auto.somanuals.com>

TV manuals search

<http://tv.somanuals.com>