

CD Radio Cassette Recorder

AZ 2025

AZ 2020

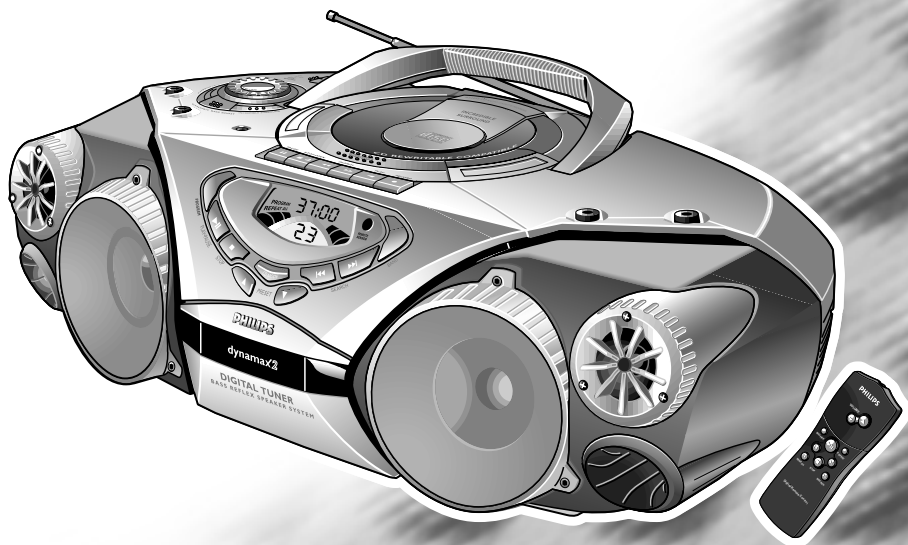

Let's make things better.



PHILIPS

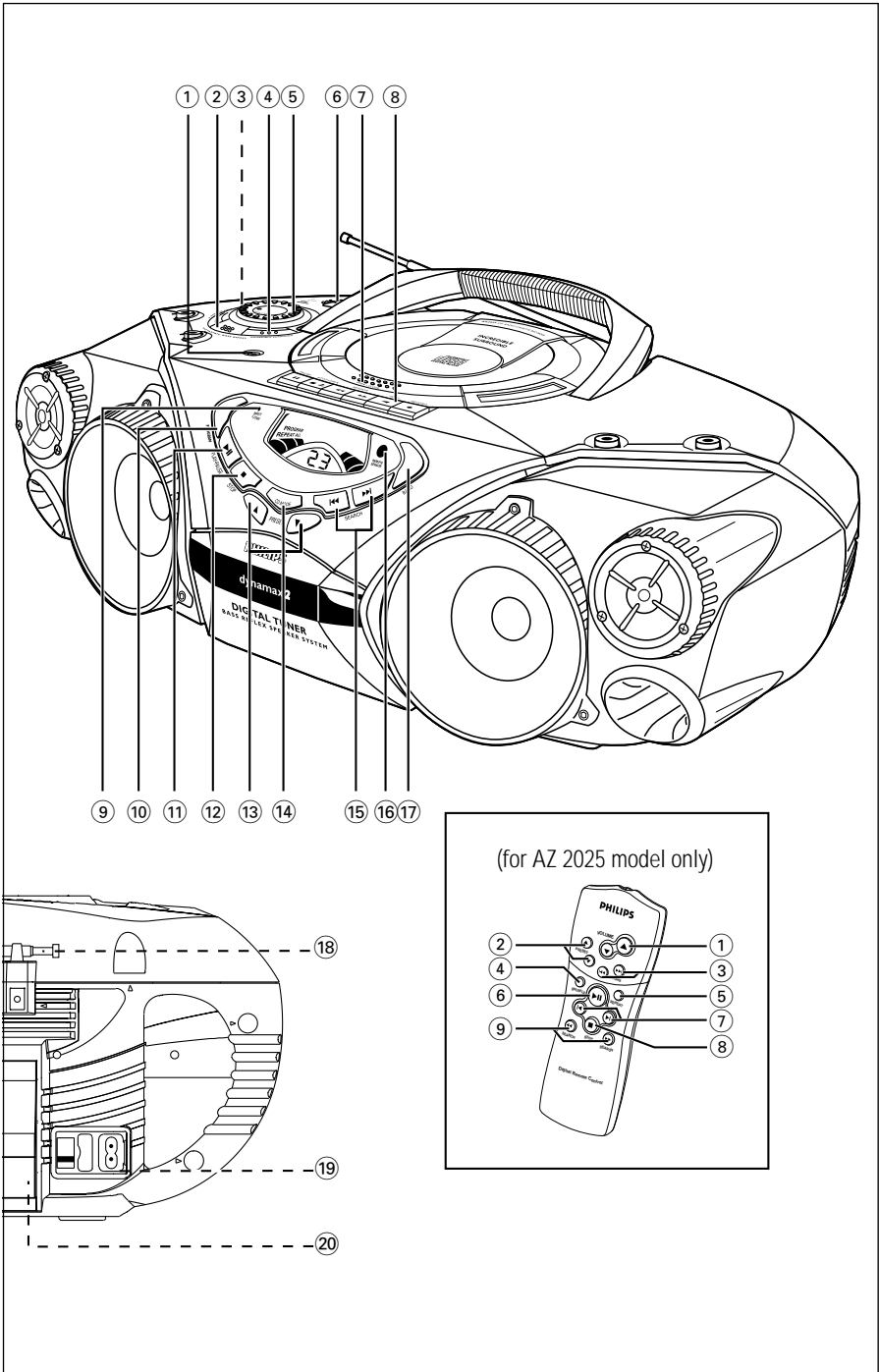

CONTROLS

TOP AND FRONT PANELS

- ① - 3.5 mm stereo headphone socket

Note: Connecting headphones will switch off the speakers.

- ② **DIGITAL DYNAMIC BASS BOOST** - selects a more vivid bass response
- ③ **ULTRA HIGH CLARITY** - adjusts the treble tones
- ④ **INCREDIBLE SURROUND** - creates a super-enhanced stereo effect
- ⑤ **VOLUME** - to adjust volume level
- ⑥ **POWER slider** - selects the sound source for CD/ TUNER / TAPE and also the POWER OFF switch
- ⑦ **OPEN•CLOSE** - opens/ closes the CD door
- ⑧ **CASSETTE RECORDER keys**
RECORD ● - starts recording
PLAY ◀ - starts playback
SEARCH ◀▶ - fast winds/rewinds the tape
STOP•OPEN ■▲ - stops the tape;
- opens the cassette compartment
- PAUSE II** - pauses recording or playback
- ⑨ **BATT LOW** - indicates when battery power is running low
- ⑩ **PROGRAM** -
CD: programmes tracks and reviews the programme;
Tuner: programmes preset radio stations
- ⑪ **PLAY PAUSE ▶II** - starts or pauses CD playback
- ⑫ **STOP ■** - stops CD playback; erases a CD programme
- ⑬ **PRESET ▼, ▲** - selects a preset tuner station (down, up)

- ⑭ **CD MODE** - selects different play modes: REPEAT or SHUFFLE (random) order
- ⑮ **SEARCH ◀▶**
Tuner: - (down, up) tunes to radio stations;
CD: - searches back and forward within a track;
- skips to the beginning of a current track/ previous/ later track
- ⑯ **REMOTE SENSOR** (for AZ 2025 model only) - infrared sensor for remote control
- ⑰ **BAND** - selects waveband

BACK PANEL

- ⑱ **Telescopic aerial** - improves FM reception
- ⑲ **AC MAINS** - inlet for mains lead
- ⑳ **Battery compartment** - for eight batteries, type R-20, UM-1 or D-cells

REMOTE CONTROL (for AZ 2025 model only)

- ① **VOLUME ▲, ▼** – adjusts volume level
- ② **PRESET ▲, ▼** (up, down) – selects a preset radio station
- ③ **TUNING ◀▶** (down, up) – tunes to radio stations
- ④ **SHUFFLE** – to play CD tracks in random order
- ⑤ **REPEAT** – repeats a track/ CD programme/ entire CD
- ⑥ **▶II** – starts and pauses CD playback/ interrupts CD playback
- ⑦ **◀, ▶** – skips to the beginning of a current track/ previous/ later track
- ⑧ **STOP ■** – stops CD playback or erases a CD programme
- ⑨ **SEARCH ◀▶** – searches backwards or forwards within a track/CD

Whenever convenient, use the mains supply if you want to conserve battery life. Make sure you remove the mains plug from the set and wall socket before inserting batteries.

BATTERIES (NOT INCLUDED)

1. Open the battery compartment and insert 8 batteries, type **R-20**, **UM-1** or **D-cells**, (preferably alkaline) with the correct polarity as indicated by the "+" and "-" symbols inside the compartment.

Remote control (supplied for AZ 2025 model only)

Open the battery compartment and insert two batteries, type **AAA**, **R03** or **UM4** (preferably alkaline).

2. Replace the compartment door, making sure the batteries are firmly and correctly in place. The set is now ready to operate.

- If **BATT LOW** lights up, battery power is running low.
 - The **BATT LOW** indicator eventually goes out if the batteries are too weak.

Incorrect use of batteries can cause electrolyte leakage and will corrode the compartment or cause the batteries to burst.

Therefore:

- Do not mix battery types: e.g. alkaline with carbon zinc. Only use batteries of the same type for the set.
- When inserting new batteries, do not try to mix old batteries with the new ones.
- Remove the batteries if the set is not to be used for a long time.
- **Batteries contain chemical substances, so they should be disposed of properly.**

Using AC POWER

1. Check if the mains supply, **as shown on the type plate located on the bottom of the set**, corresponds to your local mains supply. If it does not, consult your dealer or service centre.
2. If your set is equipped with a voltage selector, adjust the selector so that it matches with the local mains.
3. Connect the mains lead to the wall socket and the set is now ready for use.
4. To disconnect the set from the mains supply completely, remove the mains plug from the wall socket.

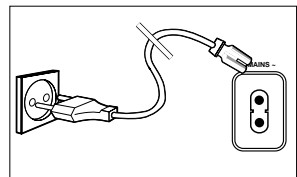
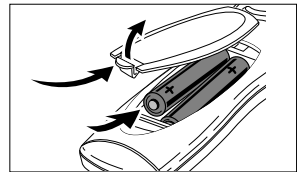
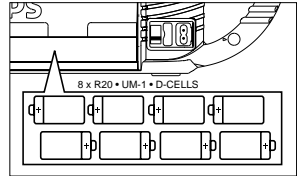

BASIC FUNCTIONS

Switching on and off

- Adjust the **POWER** slider to the desired sound source: **CD**, **TUNER** or **TAPE**.
 - The set is switched off when the **POWER** slider is in the **TAPE/OFF** position and the keys on the tape deck are released.
- The volume, tone, sound settings and tuner presets will be retained in the set's memory.
- When switching off, **TAPE** may show briefly in the display if you have been using the CD or tuner function.

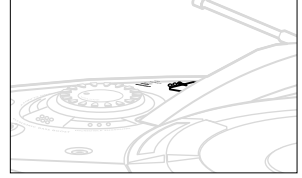

PHILIPS demo mode

1. On the set, press the **CD STOP** button for 5 seconds.
→ **PH..IL ..IPS** and demo mode messages scroll across the display continuously.
2. To return to the current display you can either:
 - press any function button on the front panel. This interrupts the demo mode for 30 seconds;
 - press the **CD STOP** button for 5 seconds. **PH..IL ..IPS** scrolls across the display once before the demo mode is cancelled.

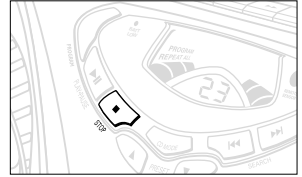

Adjusting volume and sound

1. Turn the **VOLUME** control clockwise to increase or anti-clockwise to decrease volume on the set.
For AZ 2025 model only:
Press **VOLUME** ▲ or ▼ on the remote control.
→ Display shows the volume level **Vol** and a number from 0-32.
2. Press **DIGITAL DYNAMIC BASS BOOST** once or more to switch on or off.
→ If on, indicator **1** lights up. Press again if you want extra bass and indicator **2** lights up.
3. To adjust the treble tone level, press **ULTRA HIGH CLARITY** once or more to switch on or off.
→ If on, the indicator lights up.
4. Press **INCREDIBLE SURROUND** once or more to switch the surround sound effect on or off.
→ If on, the indicator lights up.

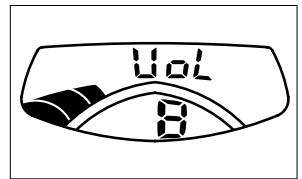
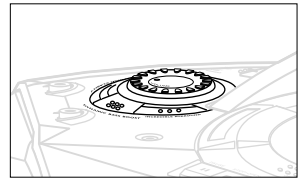

Note: The effect of **INCREDIBLE SURROUND** may vary with different types of music.

GENERAL INFORMATION

General maintenance

- Do not expose the set, batteries, CDs or cassettes to humidity, rain, sand or excessive heat caused by heating equipment or direct sunlight.
- To clean the set, use a soft, slightly dampened chamois leather. Do not use any cleaning agents containing alcohol, ammonia, benzene or abrasives as these may harm the housing.



Safety information

- Place the set on a hard and flat surface so that the system does not tilt. Make sure there is adequate ventilation to prevent the system from overheating.
- The mechanical parts of the set contain self-lubricating bearings and must not be oiled or lubricated.

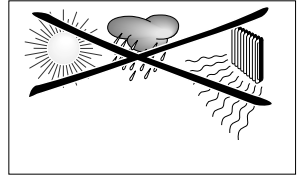

TUNING TO RADIO STATIONS

1. Select **TUNER** source.

→ **FM** is displayed briefly and then the radio station frequency is shown.

2. Press **BAND** once or more to select your waveband.

3. Press **SEARCH** **◀◀** or **▶▶** (for AZ 2025 model only: on the remote control, **TUNING** **◀◀** or **▶▶**) and release when the frequency in the display starts running.

→ The tuner automatically tunes to a station of sufficient reception. Display shows **Srch** during automatic tuning.

→ If a FM station is received in stereo, **STEREO** is shown.

4. Repeat **step 3** if necessary until you find the desired station.

- To tune to a weak station, press **SEARCH** **◀◀** or **▶▶** briefly and repeatedly until you have found optimal reception.

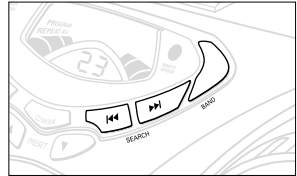

To improve radio reception

- For **FM**, pull out the telescopic aerial. Incline and turn the aerial. Reduce its length if the signal is too strong (very close to a transmitter).
- For **MW (LW)**, the set is provided with a built-in aerial so the telescopic aerial is not needed. Direct the aerial by turning the whole set.

Programming radio stations

You can store up to a total of 30 radio stations in the memory.

1. Tune to your desired station (see **Tuning to radio stations**).
2. Press **PROGRAM** to activate programming.
 - Display: **PROGRAM** flashes.
3. Press **PRESET** ▼ or ▲ once or more to allocate a number from 1 to 30 to this station.
4. Press **PROGRAM** again to confirm the setting.
 - Display: **PROGRAM** disappears, the preset number and the frequency of the preset station are shown.
5. Repeat the above four steps to store other stations.
 - You can overwrite a preset station by storing another frequency in its place.

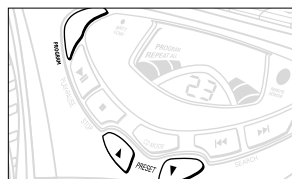
**Tuning to preset stations**

Press **PRESET** ▼ or ▲ until the desired preset station is displayed.

PLAYING A CD

This CD player plays Audio Discs including CD-Recordables and CD-Rewritables.

1. Select **CD** source.
 - **cd** is displayed briefly.
2. Press **OPEN•CLOSE** to open the CD compartment.
 - Display: ^{OPEN}
cd when you open the CD compartment.
3. Insert a CD with the printed side facing up and press **OPEN•CLOSE** to close the CD compartment.
 - Display: the CD player scans the contents of a CD, and then the total number of tracks and playing time are shown.
Display: ^{d:5C}
RF is shown if you have inserted a non-finalized CD-R(W).
4. Press **PLAY•PAUSE** ►|| (for AZ 2025 model only: on the remote control ►||) to start playback.
 - Display: Current track number and elapsed playing time of the track during CD playback.
5. To pause playback press **PLAY•PAUSE** ►||. Press **PLAY•PAUSE** ►|| again to resume play.
 - Display: the elapsed playing time flashes when playback is on pause.
6. To stop CD playback, press **STOP** ■.

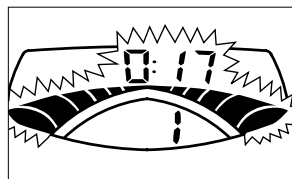
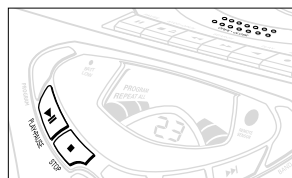

Note: CD play will also stop when:

- the CD door is opened;
- the CD has reached the end
(unless you have selected REPEAT or REPEAT ALL);
- you select another source: TAPE / TUNER.

Selecting a different track

- Press **SEARCH** ◀◀ or ▶▶ on the set, (for AZ 2025 model only: on the remote control ◀◀ or ▶▶) once or repeatedly until the desired track number appears in the display.
- If you have selected a track number shortly after loading a CD or in the PAUSE position, you will need to press **PLAY•PAUSE** ▶▶ (on the remote control ▶▶) to start playback.

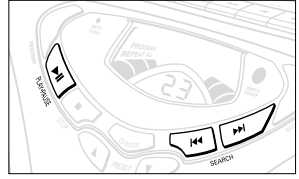

Finding a passage within a track

1. Press and hold down **SEARCH** ◀◀ or ▶▶ (for AZ 2025 model only: on the remote control ◀◀ or ▶▶).
→ The CD is played at high speed and low volume.
2. When you recognize the passage you want, release **SEARCH** ◀◀ or ▶▶.
 - Normal playback continues.

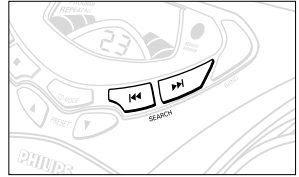

Note: During a CD programme or if SHUFFLE/ REPEAT is active, searching is only possible within a track.

Different play modes: SHUFFLE and REPEAT

You can select and change the various play modes before or during playback. The play modes can also be combined with PROGRAM.

SHUFFLE - tracks of the entire CD/ programme are played in random order

SHUFFLE and REPEAT ALL - to repeat the entire CD/ programme continuously in random order

REPEAT ALL - to repeat the entire CD/ programme

REPEAT - to play the current track continuously

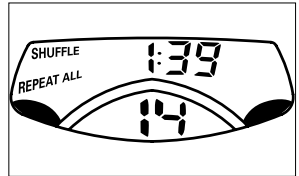

1. To select your play mode, press **CD MODE** on the set (or for AZ 2025 model only: press **SHUFFLE** or **REPEAT** on the remote control) before or during playback until the display shows the desired function.
2. Press **PLAY•PAUSE** ▶▶ to start playback if in the STOP position.
3. To return to normal playback, press the respective **SHUFFLE** or **REPEAT** button until the various SHUFFLE/ REPEAT modes are no longer displayed.
 - You can also press **STOP** ■ to cancel your play mode.

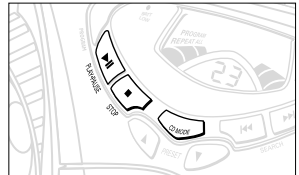

Note: In SHUFFLE mode, the display shows rapid patterns e.g. ◀◀, ▶▶ when the CD player selects a random track number.

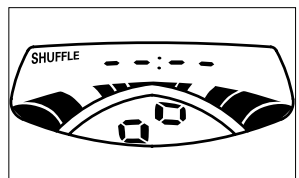

CD PLAYER

Programming track numbers

In the STOP position, select and store your CD tracks in the desired sequence. If you like, store any track more than once. Up to 20 tracks can be stored in the memory.

1. Use the **SEARCH** ◀◀ or ▶▶ on the set, (for AZ 2025 model only: on the remote control ◀◀ or ▶▶) to select your desired track number.
2. Press **PROGRAM**.
→ Display: **PROGRAM** and the selected track number *P R O G* appears briefly.
→ If you attempt to programme without first selecting a track number, *n o S E L* or *n o P R O G* scrolls across the display.
3. Repeat steps 1-2 to select and store all desired tracks.
→ *F U L L* is displayed if you attempt to programme more than 20 tracks.
4. To start playback of your CD programme, press **PLAY•PAUSE** ▶|| (for AZ 2025 model only: on the remote control ▶||).

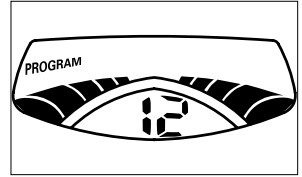
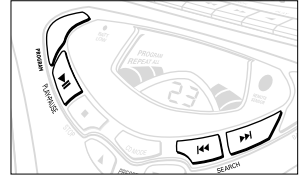

Reviewing the programme

In the STOP position or during playback, press and hold down **PROGRAM** for a while until the display shows all your stored track numbers in sequence.

Erasing a programme

You can erase the programme by:

- pressing **STOP** ■ once in the STOP position or twice during playback.
- *n o P R O G* scrolls across the display briefly and **PROGRAM** disappears.
- you select another source: TAPE / TUNER.

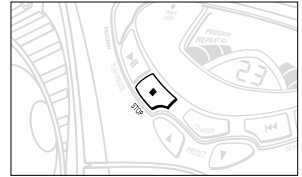

CD player and CD handling

- If the CD player cannot read CDs correctly, use a commonly available cleaning CD to clean the lens before taking the set to repair. Other cleaning methods may destroy the lens.
- The lens of the CD player should never be touched!
- Sudden changes in the surrounding temperature can cause condensation to cloud over on the lens of your CD player. Playing a CD is then not possible. Do not attempt to clean the lens but leave the set in a warm environment until the moisture evaporates.
- Always keep the CD compartment closed to avoid dust on the lens.
- To take a CD out of its box, press the centre spindle while lifting the CD. Always pick up the CD by the edge and return the CD to its box after use to avoid scratching and dust.
- To clean the CD, wipe in a straight line from the centre towards the edge using a soft, lint-free cloth. Do not use cleaning agents as they may damage the disc.
- Never write on a CD or attach any stickers to it.

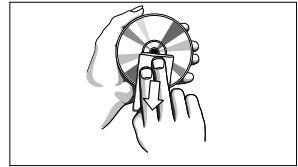
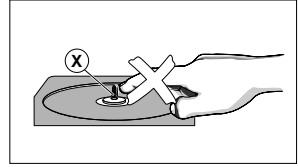

CASSETTE PLAYBACK

1. Select **TAPE** source.
→ The display shows L R P E throughout tape operation.
2. Press **STOP•OPEN** $\blacksquare \blacktriangle$ to open the cassette door.
3. Insert a recorded cassette and close the cassette door.
4. Press **PLAY** \blacktriangleleft to start playback.
5. To interrupt playback, press **PAUSE** II . To resume, press this key again.
6. By pressing **SEARCH** \ll or \gg on the set, fast winding of the tape is possible in both directions.
7. To stop the tape, press **STOP•OPEN** $\blacksquare \blacktriangle$.
– The keys are automatically released at the end of the tape and the L R P E indication goes out, except if **PAUSE** II has been activated.

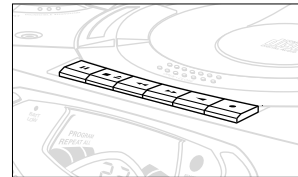

RECORDING

GENERAL INFORMATION ON RECORDING

- Recording is permissible insofar as copyright or other rights of third parties are not infringed.
- This deck is not suitable for recording on CHROME (IEC II) or METAL (IEC IV) type cassettes. For recording, use NORMAL type cassettes (IEC I) on which the tabs have not yet been broken.
- *The best recording level is set automatically.* Altering the **VOLUME, INCREDIBLE SURROUND, DIGITAL DYNAMIC BASS BOOST** or **ULTRA HIGH CLARITY** controls will not affect the recording in progress.
- At the very beginning and end of the tape, no recording will take place during the 7 seconds when the leader tape passes the recorder heads.
- To protect a tape from accidental erasure, have the tape in front of you and break out the left tab. Recording on this side is no longer possible. If, however, you wish to record over this side again, cover the tabs with a piece of adhesive tape.

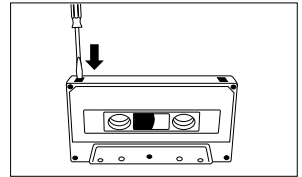

SYNCHRO START CD RECORDING

1. Select **CD** source.
2. Insert a CD and if desired, programme track numbers.
3. Press **STOP•OPEN** **■▲** to open the cassette door.
4. Insert a suitable cassette into the cassette deck and close the cassette door.
5. Press **RECORD** **●** to start recording.
 - Playing of the CD programme starts automatically from the beginning of the programme. *It is not necessary to start the CD player separately.*

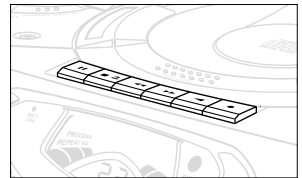

To select and record a particular passage within a track

- Press and hold down **SEARCH** **◀◀** or **▶▶** (for AZ 2025 model only: on the remote control **◀◀** or **▶▶**).
 - When you recognize the passage you want, release **SEARCH** **◀◀** or **▶▶**.
 - To pause CD playback press **PLAY/PAUSE** **▶▶||** (for AZ 2025 model only: on the remote control **▶▶||**).
 - Recording will begin from this exact point in the track when you press **RECORD** **●**.
6. For brief interruptions press **PAUSE** **||**. To resume recording, press **PAUSE** **||** again.
 7. To stop recording, press **STOP•OPEN** **■▲**.

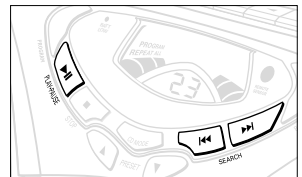

Recording from the radio

1. Tune to the desired radio station (See **TUNING TO RADIO STATIONS**).
2. Press **STOP•OPEN** ■▲ to open the cassette door.
3. Insert a suitable cassette into the cassette deck and close the cassette door.
4. Press **RECORD** ● to start recording.
5. For brief interruptions, press **PAUSE II**. To resume recording, press **PAUSE II** again.
6. To stop recording, press **STOP•OPEN** ■▲.

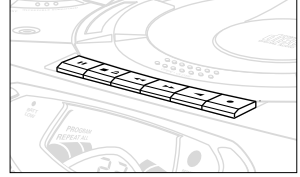

MAINTENANCE

Tape deck maintenance

To ensure quality recording and playback of the tape deck, clean parts (A),(B) and (C) shown in the diagram below, after approx. 50 hours of operation, or on average once a month. Use a cotton bud slightly moistened with alcohol or a special head cleaning fluid to clean the deck.

1. Open the cassette door by pressing **STOP•OPEN** ■▲.
2. Press **PLAY** ◀ and clean the rubber pressure roller (C).
3. Press **PAUSE II** and clean the magnetic heads (A) and also the capstan (B) .
4. After cleaning, press **STOP•OPEN** ■▲.

Note: *Cleaning of the heads can also be done by playing a cleaning cassette through once.*

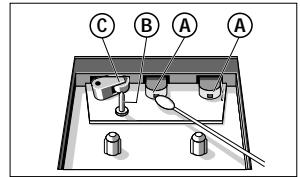

Environmental information

All unnecessary packaging material has been omitted. We have tried to make the packaging easy to separate into three mono-materials: cardboard (box), expandable polystyrene (buffer), polyethylene (bags, protective foam).

Your set consists of materials which can be recycled if disassembled by a specialized company. Please observe the local regulations regarding the disposal of packing materials, exhausted batteries and old equipment.

TROUBLESHOOTING

If a fault occurs, first check the points listed below before taking the set for repair. If you are unable to remedy a problem by following these hints, consult your dealer or service centre.

WARNING: *Do not open the set as there is a risk of electric shock. Under no circumstances should you try to repair the set yourself, as this would invalidate the guarantee.*

PROBLEM

- POSSIBLE CAUSE
- REMEDY

No sound/power

- *VOLUME* not adjusted
- Adjust the VOLUME
- *Headphones* connected
- Disconnect headphones
- *Mains lead* not securely connected
- Connect the AC mains lead properly
- *Batteries* exhausted/ incorrectly inserted
- Insert (fresh) batteries correctly

Severe radio hum or noise

- *Electrical interference:* set too close to TV, VCR or computer
- Increase the distance

Poor radio reception

- *Weak radio signal*
- FM: Direct the FM telescopic aerial for optimum reception
- MW/LW: Turn the set for optimum reception



CD indication

- *No CD* inserted
- Insert a CD
- *CD* badly scratched or dirty
- Replace/ clean CD, see Maintenance
- *Laser lens* steamed up,
- Wait until lens has cleared



CD indication

- *CD-R(W)* is blank or the disc is not finalised
- Use a finalised CD-R(W)
- *CD* badly scratched or dirty
- Replace/ clean CD, see Maintenance

The CD skips tracks

- *CD* is damaged or dirty
- Replace or clean the CD
- *SHUFFLE* or *PROGRAM* is active
- Switch off SHUFFLE / PROGRAM

Poor cassette sound quality

- *Dust and dirt* on the heads, etc.
- Clean deck parts etc., see maintenance
- *Use of incompatible cassette types* (METAL or CHROME).
- Only use NORMAL (IEC I) for recording.

Recording does not work

- *Cassette tab(s)* may be broken
- Apply a piece of adhesive tape over the missing tab space.

Remote control does not function properly

- *Batteries* exhausted/ incorrectly inserted
- Insert (fresh) batteries correctly
- *Distance/ angle* between the set too large
- Reduce the distance/ angle

***This product complies with the radio interference requirements of the European Union.
The type plate is located on the bottom of the set.***

Free Manuals Download Website

<http://myh66.com>

<http://usermanuals.us>

<http://www.somanuals.com>

<http://www.4manuals.cc>

<http://www.manual-lib.com>

<http://www.404manual.com>

<http://www.luxmanual.com>

<http://aubethermostatmanual.com>

Golf course search by state

<http://golfingnear.com>

Email search by domain

<http://emailbydomain.com>

Auto manuals search

<http://auto.somanuals.com>

TV manuals search

<http://tv.somanuals.com>