

VCD MP3 CD Soundmachine



**EXPANIUM**

*Let's make things better*

Downloaded from [www.Somanuals.com](http://www.Somanuals.com). All Manuals Search and Download



**PHILIPS**

English

## English

MP3 General Information.....5	Radio.....9
Controls.....6	CD/VCD/MP-CD.....10–15
Remote Controls.....7	Cassette recorder.....16–17
Power Supply.....8	Maintenance.....18
General Operation.....9	Troubleshooting.....19

中文

## 中文

MP3 General Information.....21	Radio.....25
Controls.....22	CD/VCD/MP-CD.....26–31
Remote Controls.....23	Cassette recorder.....32–33
Power Supply.....24	Maintenance.....34
General Operation.....25	Troubleshooting.....35

1

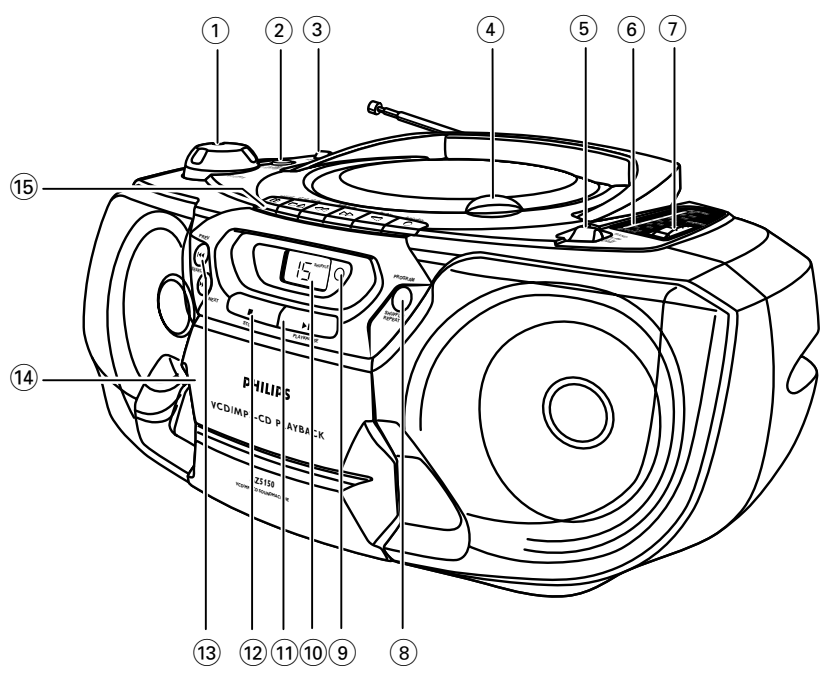

2

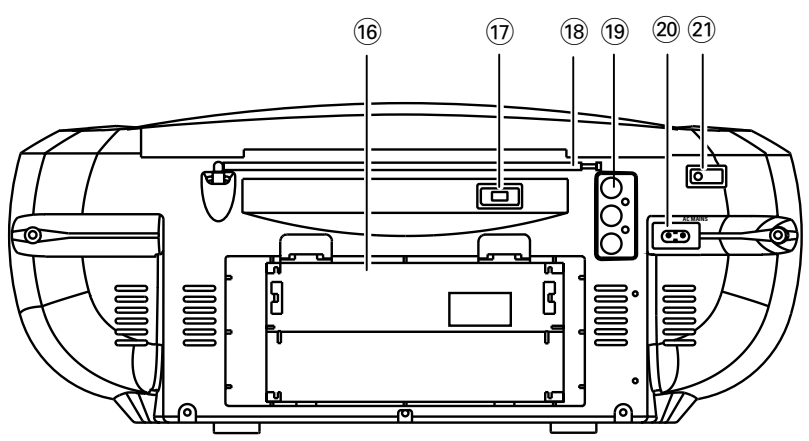

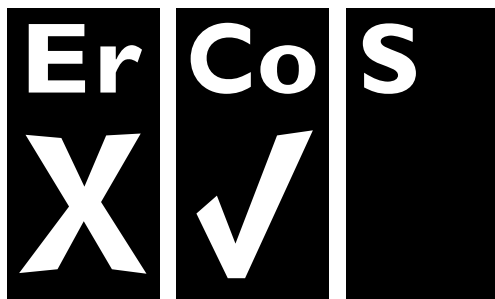

### **Optimum disc playability : ensuring excellent picture quality**

Philips components and modules for the various CD applications have always enjoyed an excellent reputation in the market place for super disc playability - the ability to play discs which may be scratched, soiled or not fully according to the standard specification. This position has been underlined by tests showing the superior performance of the various Philips players, as well as by the positive experiences of millions of individual consumers around the world.

### **Constantly improving performance**

As the penetration of the CD system has increased, and new applications like CD-ROM and Video CD have become commonplace, Philips Components - as the CD technology inventor and as one of the major suppliers of CD player modules in the industry - has constantly improved the performance of its products.

One of the ways in which this benefits users is by optimum disc playability. This is an important parameter for CD players other than CD Audio, and especially for the Video CD applications, because any loss of data from the disc will at best cause disturbances in the reproduced picture, and at worst can cause the player to lose track so that disc playing fails.

### **Presenting Super Error Correction**

To ensure consistently good results when playing Video CD discs of all quality grades and conditions, Philips has introduced further improvements in the system's playability. These developments together are called Super Error Correction, a proprietary Philips technology optimizing the system's ability to handle less-than-perfect discs with the minimum disturbance to normal playing.

By effectively eliminating virtually all errors arising under normal playing conditions, Super Error Correction ensures that the picture quality as seen by the user is independent of disc play. The video encoding and processing during mastering of the disc, and the MPEG-1 decoding and video encoding in the signal processing stages, are now the only limiting factors for picture quality.

## Dear Customer,

Thank you for buying the Philips MP3-CD Soundmachine. Your great new acquisition will allow you to listen to up to 10 hours of CD-like quality music, using the revolutionary new music compression technology MP3.

## MP3 technology

MP3 is short for MPEG1 Layer-3 encoding and decoding technology, a very powerful encoding algorithm with which you can shrink down the original Digital Audio sound data with a factor of up to 10 without losing significant sound quality.

## Recording and Playback

It is recommended to set your recording bit rate to 128Kbps, sampling frequency at 44.1KHz to achieve CD-like music playback quality.

Since downloading MP3 files from the Internet, ripping songs from your own legal CD's and burning MP3 songs onto a CD-R, are a delicate process, the quality of a MP3 song may vary by these process. Subsequently, making a MP3-CD may not be entirely perfect.

**As a result of the above imperfection, you may experience an occasional "skip" while listening, or an occasional delay in accessing "previous/next" title to MP3-CD's. This is considered to be normal.**

A comparison chart is enclosed as below:

Sound Quality	Bit Rate	Approximate Reduction Ratio	Approximate total MP3-CD time	Comment
AM radio	32 kbps	40 : 1	40 hrs	Sound quality significantly affected-not recommended.
FM radio	64 kbps	20 : 1	20 hrs	
Near-CD	96 kbps	15 : 1	15 hrs	Balanced sound quality compression rate.
CD-like	128 kbps	10 : 1	10 hrs	
CD	256 kbps	5 : 1	5 hrs	Compression rate low suggest to play CDs instead.
CD	320 kbps	3 : 1	3 hrs	

# CONTROLS

## TOP AND FRONT PANEL

- ① **VOLUME** - to adjust volume level.
- ② **DBB (Dynamic Bass Boost)** - : for a more vivid bass response.
- ③ **Source selector** - POWER ON/OFF switch and to select source of sound source: DISC- TAPE - RADIO.
- ④ **LIFT TO OPEN** - to open the CD door.
- ⑤ **Band selector** - to select FM/MW wave band
- ⑥ **Tuning dial pointer**
- ⑦ **TUNING** - to tune to radio stations
- ⑧ **PROGRAM** - to program track numbers and to review the program.
- ⑨ **REMOTE SENSOR** - infrared sensor for remote control
- ⑩ **LCD Display** - to show the CD, VCD, MP3 functions.
- ⑪ **PLAY•PAUSE ►||** - To start or interrupt CD playback.
- ⑫ **STOP ■** - to stop playback.
- ⑬ **SEARCH ◀◀ or ▶▶** - to skip or search a passage or a track
- ⑭ **Cassette compartment**
- ⑮ **Cassette keys:**
  - PAUSE ||** - to interrupt recording or playback.
  - STOP•OPEN ■ ▲** - To stop the tape and to open the cassette holder.
  - SEARCH ◀◀ or ▶▶** - to fast wind/rewind the tape.
  - PLAY ◀** - to start playback.
  - RECORD ●** - to start recording.

## BACK PANEL

- ⑮ **Battery door** - to open the battery compartment
- ⑰ **FM MODE/OSC/COLOUR SYSTEM selector**
  - FM MODE : to select FM reception in stereo or mono sound
  - OSC (beat cut) : to eliminate whistling tones during MW(AM) recordings
  - COLOUR SYSTEM SELECTOR : to switch the PAL or NTSC system.
- ⑱ **Telescopic aerial** - to improve radio reception
- ⑲ **VIDEO/AUDIO OUT** - connect to the TV or VCR VIDEO/AUDIO IN
- ⑳ **AC MAINS** - socket for mains lead
- ㉑ **PHONES** - 3.5 mm stereo headphone socket

## SUPPLIED ACCESSORIES

Remote Control	.....	1 pc
Mains Cord	.....	1 pc
Audio / Video Cable	.....	1 pc

# REMOTE CONTROL

## REMOTE CONTROL

- ① **PBC (PLAYBACK CONTROL)** - to switch on or off PBC mode (for VCD version 2.0 only).
- ② **RETURN** - to return to the previous MENU level during playback (for VCD with PBC on).
- ③ **VIEW** - to scan through a VCD with 9 pictures display on TV screen. Only when PBC mode is switched off (for VCD operation only).
- ④ **OSD** - to switch on/off the on screen display on the TV screen.
- ⑤ **SLOW** - to watch a VCD at a slower speed (for VCD operation only).
- ⑥ **RESUME** - to resume playback in stop mode.
- ⑦ **GOTO** - to start playback at any chosen time on the disc (for CD/VCD operation only).
- ⑧ **PROG**  
for CD/VCD/MP3-CD ... to programme disc tracks.
- ⑨ **REPEAT**  
for MP3-CD only ... to repeat a track, an album or whole disc.  
for CD/VCD ... to repeat a disc track or the whole disc.
- ⑩ **A - B** - to playback a certain scene or passage repeatedly (for CD/VCD operation only).
- ⑪ **ZOOM**  
for VCD only ... to zoom out picture.
- ⑫ **SHUFFLE** - When in CD/VCD mode, press to start or stop shuffle play mode.
- ⑬ **NTSC/PAL** - to select the video output for NTSC or PAL system.
- ⑭ **R/L** - to select MONO LEFT / MONO RIGHT / STEREO.
- ⑮ **DIGITS 0 - 9, +10**  
for CD/VCD/MP3-CD ... to select a track number.
- ⑯ **PLAY/PAUSE** **▶||**  
for CD/VCD/MP3-CD ... to start or interrupt playback.

- ⑰ **ALBUM** **◀▶**  
for MP3-CD only ... to select previous / next album  
for CD/VCD ... to skip to the previous/next track.
- ⑱ **TITLE** **◀▶▶▶**  
for MP3-CD only ... to select previous/next title.  
for CD/VCD ... to search backward/forward track.
- ⑳ **STOP** **■**  
for CD/VCD/MP3-CD ... to stop playback or to clear a programme.

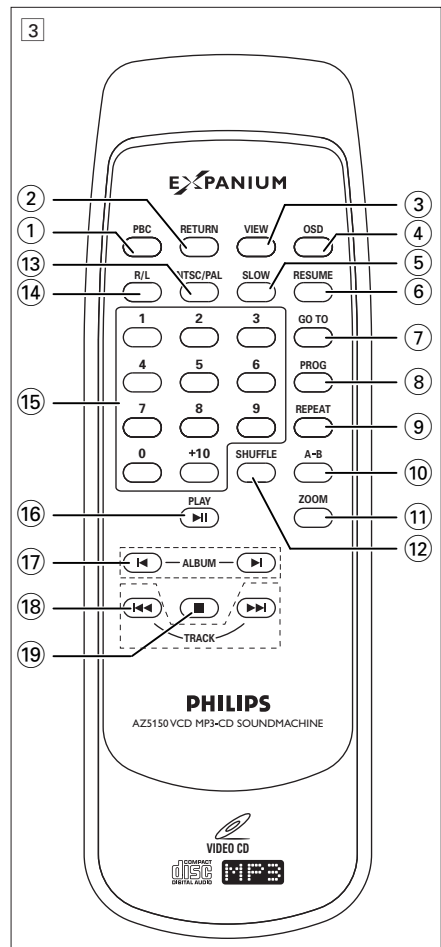

# POWER SUPPLY

## BATTERIES (NOT SUPPLIED)

Whenever convenient, use the mains supply if you want to conserve battery life. The battery supply will be switched off when the set is connected to the mains. Make sure you remove the plug from the set and wall outlet before inserting batteries.

### Batteries

1. Open the battery compartment and insert six batteries, type **R-20, UM-1** or **D-cells**, (preferably alkaline) with the correct polarity as indicated by the "+" and "-" symbols inside the compartment.

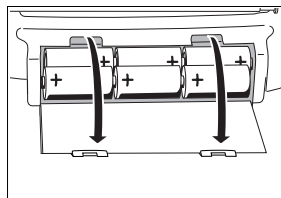

### Remote control

Open the battery compartment and insert two batteries, type **AAA, R03** or **UM4** (preferably alkaline).

2. Replace the compartment door, making sure the batteries are firmly and correctly in place.

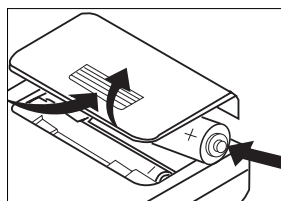

3. Remove the batteries if they are exhausted or if they will not be used for a long period.

- The incorrect use of batteries can cause electrolyte leakage and will corrode the compartment or cause the batteries to burst. Therefore:
  - Do not mix battery types, e.g. alkaline with zinc carbonate.
  - When inserting new batteries, replace all at the same time.
  - Remove the batteries if the set is not to be used for a long time.

**Note :** The battery supply is switched off when the set is connected to the mains.

**Batteries contain chemical substances, so they should be disposed of properly**

## MAINS

1. Check if the mains voltage as shown on the type plate (on the bottom of the set) corresponds to your local mains voltage. If it does not, consult your dealer or service organisation.

2. Connect the mains lead to the **~ AC IN** socket and the wall socket.

→ The set is now ready for use.

3. To switch off the mains supply completely, pull the mains plug out of the wall socket.

→ Disconnect the mains lead when you change over to battery supply, or to protect the set during heavy thunderstorms.

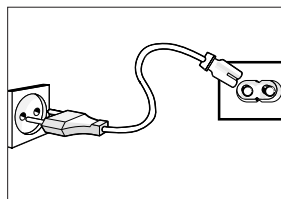

**The type plate is located on the bottom of the set.**

## CAUTION

**Use of controls or adjustments or performance of procedures other than herein may result in hazardous radiation exposure or other unsafe operation.**



## GENERAL OPERATION

1. To switch on the set, adjust the source selector.
  - The POWER indicator lights up.
2. Adjust the sound using the **VOLUME** and **DBB** controls.
3. To switch off the radio, adjust the source selector to the **TAPE/POWER OFF** position, with the cassette keys released.
  - The POWER indicator goes out.

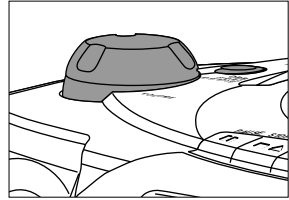

## RADIO RECEPTION

1. Set the source selector to **RADIO**.
  - The POWER indicator lights up.
2. Adjust the sound using the **VOLUME** controls and the **DBB** switch.
3. Select the wave band using the **BAND** selector.
4. Tune to a radio station using the **TUNING** knob.
  - For FM, pull out the telescopic aerial. To improve FM-reception, incline and turn the aerial. Reduce its length if the FM-signal is too strong (very close to a transmitter).
  - For MW, the set is provided with a built-in aerial, so the telescopic aerial is not needed. Direct the aerial by turning the whole set.
5. To switch off, set the source selector to the **TAPE/POWER OFF** position (with the cassette keys released).
  - The POWER indicator goes out.

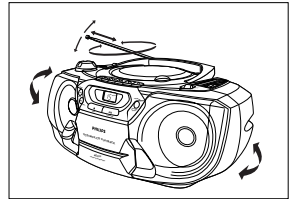
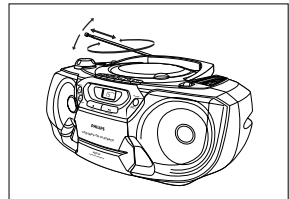

## Environmental information

All unnecessary packaging material has been omitted. We have done our utmost to make the packaging easily separable into three mono materials: cardboard, polystyrene and plastic.

**Your set consists of materials which can be recycled if disassembled by a specialized company. Please observe the local regulations regarding the disposal of packaging materials, exhausted batteries and old equipment.**

# CD/VCD/MP3-CD

## IMPORTANT!

The CD part of this system also serves as a Video CD player if you connect it to your TV set.

Before viewing the Video CD, ensure that the set is switched to corresponding PAL or NTSC system of your TV set (exception Multi-system TV).

## DISCS FOR PLAYBACK

This set can playback all digital audio CD, video CD, finalised digital audio CD-Recordable (CDR) discs and finalised digital audio CD-Rewritable (CDRW) discs.



### Support following MP3-CD formats:

- ISO 9660 format - Max. 17 characters
- Max. Track number plus Album is 256
- Max. nested directory is 8 levels
- The max. ALB number is 99
- The max. MP3 programme track number is 99
- The max. length of each track is 255 minutes 59 seconds
- The player can play mixed mode disc:
  - a: MP3 + CDDA can only play the MP3 tracks in the first block.
  - b: VCD + CDDA full support
- Supported VBR bit-rate
- Supported sampling frequencies for MP3 disc : 32 kHz, 44.1 kHz, 48 kHz
- Supported Bit-rates of MP3 disc are: 32, 64, 96, 128, 192, 256 (kbps)



### Following formats are not supported

- The files like \*.WMA, \*.AAC, \*.DLF, \*.M3U, \*.PLS
- Chinese filename
- The non-session closed discs
- The discs recorded under UDF format
- Multi-session discs (can only play the first session if the session's format is the supported format).

## LOADING A DISC

1. Set the source selector to Disc.
  - The POWER indicator lights up.
2. Press OPEN to open the CD door.
3. Insert a disc with the label side facing up.
4. Close the CD door.
  - The total number of tracks and the playing time of the disc appear on the display.

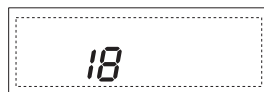

### For MP3-CD only

- The total album number "ALB 1" will be displayed
- On TV screen, the total ALBUM and TRACK number will display, also with the album list (max. 5 lines per page) and an arrow. The arrow indicates the current selected music.

**Notes :** - To ensure good system performance, wait until the disc is completely reads before proceeding.

- For MP3-CD, the disc reading time may exceed 10 seconds due to the large number of songs compiled into one disc.

## PLAYING A NORMAL DISC

- Press ► to start playback.
    - The track number and elapsed playing time of the current track appear on the display.
  - To interrupt playback, press ►.
    - The playing time will start flashing.
  - To resume playback, press ► again.
- To stop playback, press ■.

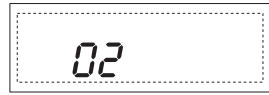

## SELECTING A DESIRED TRACK/PASSAGE

### To select a desired track

- Press ◀◀ or ▶▶ on the set repeatedly (or on the remote control, press ◀ or ▶) or digits 0 - 9, +10) until the desired track appears on the display.
- If playback is stopped, press ► to start playback.

### To search for a particular passage during playback

- Press and hold ◀◀ or ▶▶ on the set (or on the remote control, press ◀◀ or ▶▶) and release it when the desired passage is located.
  - During searching, the volume will be reduced.

### For MP3-CD only

#### To select a desired Album

- Press and hold ◀◀ or ▶▶ on the set (or on the remote control, press ◀ or ▶) until the desired album number appear on the display.
  - "R X X" will be displayed and the album name will scroll through the display briefly.
  - On TV screen, the arrow will move forward/backward in the ALBUM menu.

#### To select a desired Track

- Press ◀◀ or ▶▶ on the set repeatedly (or on the remote control, press ◀◀ or ▶▶) to select a desired track from the current Album.
  - "R Q I" will be displayed and the track name will scroll through the display briefly.
  - On TV screen, the arrow will move forward/backward in the TRACK menu.
- Use the digital keys on the remote control to select the track under current Album directly.

#### To select and playback another track during playback mode

- Press ◀◀ or ▶▶ on the set (or on the remote control, press ◀ or ▶) repeatedly to select another track.
  - The current track continues playing.
  - The new selected track will show on the display screen and TV screen.
- Press ► to start playback the new selected track.

**Note :** - "R" represents ALBUM is the current selected Album.

## PROGRAMMING TRACKS

Programming tracks of disc is possible when playback is stopped. Up to 20 tracks can be stored in the memory in any order (except for MP-3 CD).

1. In stop mode, press **PROGM** to enter programme setting.  
→ **PROG** will start flashing.
2. Press **digits 0 - 9, +10** on the remote control or **◀/▶** to select the desired track.
3. Press **PROGM** to store the select track.  
→ "PXX TXX" will show on the display screen and "PXX ◻K" on TV screen.
  - Repeat steps **1** to **3** to store other tracks.
4. Press **■** to end programme setting.  
→ **PROG** will remain on the display.
  - Press **◀** or **▶** on the set (or on the remote control, press **◀** or **▶**) in stop mode to review the programme sequence.
5. Press **■** to play the programmed tracks.
  - If you press **REPEAT** during programme playback, the current track or all programmed tracks will be played repeatedly.  
→ **REPEAT/REPEAT ALL** and **PROG** will appear on the display.
6. Press **■** in stop mode to clear the programme.  
→ "CLR PPG" will be displayed.  
→ **PROG** will disappear from the display.

**Notes :** - "P" represents PROGRAMME and "T" represents TRACK, "XX" is the current selected Programme or Track number.  
- The programming is automatically cleared as soon as the CD compartment is opened.  
- The function of programme setting is disable in PLAY/PAUSE mode.  
- Programme cannot be used for VCDs when PBC is switched on. Switch off PBC before storing tracks from such a VCD.

### For MP3-CD only

1. In stop mode, press **PROGM**.  
→ PROG will start flashing and "PXX" will be displayed.  
→ On TV screen, "PXX AXX TXX?" and "PROGRAM" will be displayed.
2. Press and hold **◀/▶** to select the desired ALBUM and press **◀/▶** repeatedly (or **digits 0 - 9, +10** on the remote control) to select the desired TRACK for programming.
3. Press **PROGM** to store the select track.  
→ "PXX" will show on the display screen and "PXX ◻K" on TV screen.  
→ **PROG** will remain on the display.
  - Repeat steps **1** to **3** to store other desired album and track.
  - Press **◀** or **▶** in stop mode can review the programme sequence.  
→ "PXX AXX TXXX" will show on TV screen.
  - Press **◀/▶** in stop mode to show the programme information.  
→ The Album's number and Track's number will show on the display screen.
4. Press **▶** to start programme playback. You can press **◀/▶** to select the programmed track to play.
5. Press **■** **once** stop programme playback or **twice** to clear the programme.

## SHUFFLE

You can play all the tracks in random order.

1. During playing, pause or stop mode, press **SHUFFLE** to enable SHUFFLE play mode.  
→ **SHUFFLE** will appear on the display.
2. To exit shuffle mode, press **SHUFFLE** again or **■**.  
→ **SHUFFLE** will disappear from the display.

**Note :** - If the Shuffle function enabled, and the Repeat function is set on, will disable the Shuffle play mode.

## REPEAT

You can play the current track or the whole disc repeatedly.

1. During CD Playing or Pause mode, press **REPEAT** on the set or remote control.  
→ **REPEAT** - to repeat the current track.  
→ **REPEAT ALL** - to repeat the whole disc.
- For MP3-CD, you are able to select REPEAT, REPEAT ALL or REPEAT ALB mode.  
→ **REPEAT ALB** - to repeat the current album.
- The current track or whole disc will now be played repeatedly until you press **■**.
2. To exit the repeat mode, press **REPEAT** until the **REPEAT/REPEAT ALL/REPEAT ALB** disappears from the display.

**Notes :** - If the Repeat function is enable, and the Shuffle function is set on, will disable all the Repeat play modes.  
- If the Repeat function is enable, and the Stop button is pressed, will disable all the Repeat play modes.  
- In programme mode, you can only select Repeat or Repeat All function.

## VIDEO CD

### Adjusting the TV System

Before viewing the Video CD, ensure that the set is switched to corresponding PAL or NTSC system of your TV set (exception Multi - system TV).

1. Set the colour system selector to the **PAL/A** or **NTSC/B** position as default setting. After TV system is selected, the set will automatically switch to the default setting every time the VCD source is selected.
2. On the remote control, press **NTSC/PAL** to switch between NTSC and PAL TV system.

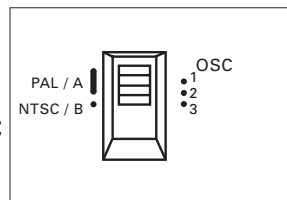

### OSD - On Screen Display

If you insert VCD/CD, your TV screen will serve as an additional display for messages (e.g. PLAY, STOP), and information stored on the VCD/CD.

- Press OSD on the remote control to select viewing various information.  
→ The current track and current /remaining time in the track/disc appear on the display.

## VIDEO CD

### Playing a Video CD with PBC

VCD with PBC (Playback Control) will be indicated on the display of the set and on your TV screen as soon as they are inserted. PBC is a predefined play sequence stored on the VCD.

1. Switch on the TV, insert a VCD with PBC.
2. Menu appears on the TV screen.

### If the menu consists of a list of titles, you can select a sequence directly

1. Press **digits 0 - 9, +10** on the remote control to select your choice.  
→ The VCD starts playing of the selected sequence automatically.
  2. Press **RETURN** on the remote control to go back to the previous menu.
- Note** : - If a menu consists of more than one page, press **◀/▶** to go through the pages.

### Switching off PBC

- In stop mode, press **PBC**.  
→ On TV screen, "PBC OFF" will be displayed.

**Notes** : - Programme mode is not available whenever PBC mode is switched on.  
- The menu structure depends on the programme stored on the VCD. Please refer to the information supplied with the disc.

### Pause

1. During playback, press **▶** to have a still picture on the TV screen.  
→ The sound will be muted.  
→ On TV screen, "PAUSE" will be displayed.
2. Press **▶** again to continue playback.

### Goto

1. Press **GOTO** on the remote control.  
→ "--:--" will be displayed.  
→ On TV screen, "GOTO --:--" will be displayed.
2. Press **digits 0 - 9, +10** on the remote control to key in the disc time which you want the disc to begin playback.

**Note** : - The disc time entered should not be greater than the total disc time.

### Slow

1. Press **SLOW** on the remote control to watch a VCD at a slower speed. There are 3 types of slow modes to select.  
→ The sound will be muted.  
→ On TV screen, "SLOW 1/2", "SLOW 1/4" or "SLOW 1/8" will be displayed.
2. To resume playback at normal speed, press **SLOW** repeatedly until "PLAY" appears on the TV screen or press **▶**.

## VIDEO CD

### A-B repeat

This feature is also applicable to audio CD (except for MP3-CD). To Play a certain scene or passage of the disc repeatedly.

1. Press **A-B** on the remote control during playback to mark the start point of the chosen scene or passage.  
→ "**A→**" will appear on the display.
2. Press **A-B** again to mark the end of the chosen scene or passage.  
→ "**A→B**" will appear on the display.  
→ The selected scene or passage will start playing repeatedly.
3. Press A-B once more to return to normal playback.  
→ "**A→B**" will disappear from the display.

**Notes** : - You can also cancel A-B repeat by pressing ◀◀ or ▶▶.  
- A-B repeat marking can cross from one track to another. But for VCD 2.0, you can only able to set the A-B repeat marking within the same track.

### Resume

- In stop mode, press **RESUME** on the remote control to start playback again from where you have stopped.

**Note** : - Resume will not be available if you have changed the disc, opened the disc tray or disconnected the system the power supply.

### View

This feature allows you to scan through a VCD for a quick review. PBC mode must be switched off.

1. Press **VIEW** on the remote control.  
→ On TV screen, 9 pictures will be displayed. To view the previous/next page, press ◀◀ or ▶▶.  
→ The first 20 seconds of each track will be played.
2. To exit review mode, press **digits 0 - 9, +10** to playback the desired track or ▶ to play the current selected track.

**Note** : - If the disc is AVCD disc and there're no video tracks on the same viewed page, cannot use the direct digital key to play the track.

### Return

- Press **RETURN** on the remote control to return to the previous VCD disc MENU level. It is functional only for Video CD when PBC is switched on.

### R/L

You can use it to select the different audio modes.

- Press **R/L** on the remote control repeatedly to select the following modes:
- Channel Left/Right - Select the language on a bilingual VCD.

# CASSETTE RECORDER

## CASSETTE PLAYBACK

1. Set the source selector to **TAPE/POWER OFF**.
2. Press **STOP•OPEN** ■ ▲ to open the cassette holder.
3. Insert a recorded cassette.
4. Press **PLAY** ◀ and playback will start.
  - The **POWER** indicator lights up.
5. Adjust the sound using the **VOLUME** and **DBB** controls.
6. For brief interruptions, press **PAUSE II**. Press **PAUSE II** again to resume playback.
7. By pressing ◀◀ or ▶▶, fast winding of the tape is possible in both directions.
8. To stop playback, press **STOP•OPEN** ■ ▲
  - The keys are automatically released at the end of the tape.
9. Set the source selector to **TAPE/POWER OFF** position (with the cassette keys are released) to switch off the set.
  - The **POWER** indicator goes out.

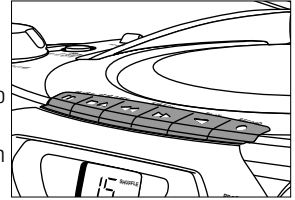

## CASSETTE RECORDING

### General information on cassette recording

- Recording is permissible insofar as copyright or other rights of third parties are not infringed.
- This deck is not suitable for recording on **CHROME (IEC II)** or **METAL (IEC IV)** type cassettes. For recording you should use **NORMAL** type cassettes (**IEC I**) on which the tabs have not been broken.
- Check and tighten slack tape before use with a pencil, to avoid jamming the deck mechanism.
- The recording level is set automatically. Altering the **VOLUME** and **DBB** controls will not affect the recording in progress.
- No recording will take place during the 7 seconds, when the leader tape passes the recorder heads.
- To prevent the accidental erasure of a recording, keep the cassette side to be safeguarded in front of you and break out the left tab. Recording on this side is no longer possible.

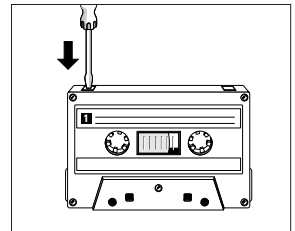



## RECORDING FROM THE RADIO

1. Set the source selector to **TUNER**.
  - The POWER indicator lights up.
2. Tune to the desired radio station using the TUNING knob.
3. Press **STOP•OPEN** ■ ▲ to open the cassette holder.
4. Insert a blank tape.
5. Press **RECORD** ● to start recording.
  - A whistling sound during AM recordings can be eliminated by setting the OSC switch to any of the three positions (1,2 or 3) to give the best reception.
6. For brief interruptions, press **PAUSE II**. To resume recording, press **PAUSE II** again.
7. To stop recording, press **STOP•OPEN** ■ ▲

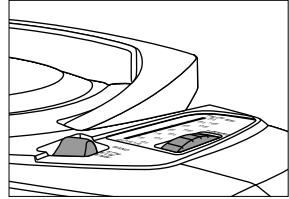

## SYNCHRO START CD RECORDING

1. Set the source selector to **CD**.
  - The POWER indicator lights up.
2. Insert a CD and if desired, programme track numbers.
3. Press **STOP•OPEN** ■ ▲ to open the cassette holder.
4. Insert a blank cassette.
5. Press **RECORD** ● to start recording.
  - Playing of the CD programme starts automatically from the beginning of the programme. It is not necessary to start the CD player separately.
6. For brief interruptions, press **PAUSE II**. To resume recording, press **PAUSE II** again.
7. To stop recording press **STOP•OPEN** ■ ▲

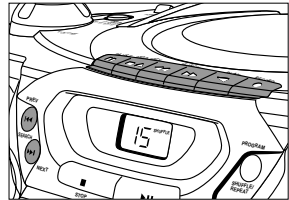

### To select and record a particular passage within a track

1. Press **SEARCH** ◀◀ or ▶▶ to select a passage.
2. Put the CD player in **PAUSE II** position at the selected passage.
  - Recording will start from this exact point when you press **RECORD** ●.

# MAINTENANCE

## PRECAUTIONS & GENERAL MAINTENANCE

- Place the set on a hard, flat surface so that the system does not tilt.
- Do not expose the set, CDs, batteries or cassettes to humidity, rain, sand or excessive heat caused by heating equipment or direct sunlight.
- Always shut the CD door to keep the CD compartment dust-free. To clean, dust the compartment with a soft dry cloth.
- Do not cover the set. Adequate ventilation with a minimum gap of 15 cms between the ventilation holes and surrounding surfaces is necessary to prevent heat build-up.
- The mechanical parts of the set contain self-lubricating bearings and must not be oiled or lubricated.
- To clean the set, use a soft, slightly dampened chamois leather. Do not use any cleaning agents containing alcohol, ammonia, benzene or abrasives as these may harm the housing.

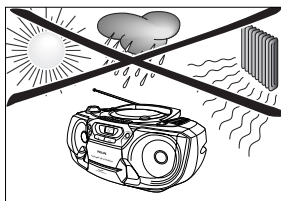

## CD PLAYER AND CD HANDLING

- The lens of the CD player should *never be touched*.
- Sudden changes in the surrounding temperature can cause condensation to form and the lens of your CD player to cloud over. Playing a CD is then not possible. Do not attempt to clean the lens but leave the set in a warm environment until the moisture evaporates.
- Use only Digital Audio CDs.
- To take a CD out of its box, press the centre spindle while lifting the CD.  
Always pick up the CD by the edge and replace the CD back in its box after use to avoid scratching and dust.
- To clean the CD, wipe in a straight line from the centre towards the edge using a soft, lint-free cloth. Do not use cleaning agents as they may damage the disc.
- *Never write* on a CD or attach stickers to it.

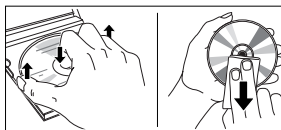
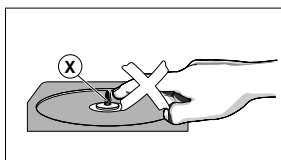

## TAPE DECK MAINTENANCE

To ensure a good recording and playback of the tape deck, clean parts (A), (B) and (C) show in the diagram below, after approx. 50 hours of operation, or on average once a month. Use a cotton bud slightly moistened with alcohol or a special head cleaning fluid to clean the deck.

- Open the cassette holder by pressing **STOP•OPEN** ■ ▲.
- Press **PLAY** ◀ and clean the rubber pressure rollers (C).
- Press **PAUSE** || and clean the magnetic heads (A) and also the capstans (B).
- After cleaning, press **STOP•OPEN** ■ ▲.

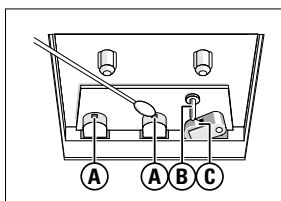

Cleaning of the heads can also be done by playing a cleaning cassette through once.

If a fault occurs, first check the points listed below before taking the set for repair.

If you are unable to remedy a problem by following these hints, consult your dealer or service centre.

**WARNING:** *Do not open the set as there is a risk of electric shock. Under no circumstances should you try to repair the set yourself, as this will invalidate the guarantee.*

## Problem

## Solution

### CD/VCD OPERATION

"NO DISC" is displayed

- Insert a disc.
- Check if the disc is inserted upside down.
- Wait until the moisture condensation at the lens has cleared.
- Replace or clean the disc, see "Maintenance"
- Use a readable disc or correct recorded format MP3-CD.

No picture on TV screen

- Connect the cable between the system and TV.

No colour on TV

- Change the system to the respective PAL or NTSC setting.

### RADIO RECEPTION

Radio reception is poor

- If the signal is too weak, adjust the antenna for better reception.
- Increase the distance between the Receiver and your TV or VCR.

### TAPE OPERATION/RECORDING

Recording or playback cannot be made

- Clean deck parts, see "Maintenance".
- Use only NORMAL (IEC I) tape.
- Apply a piece of adhesive tape over the missing tab space.

### GENERAL

The system does not react when buttons are pressed

- Remove and reconnect the AC power plug and switch on the system again.

Sound cannot be heard or is of poor quality

- Adjust the volume.
- Make sure the MP3-CD was recorded within 32-256 kbps bit rate with sampling frequencies at 48 kHz, 44.1 kHz or 32 kHz.

The remote control does not function and properly

- Reduce the distance between the remote control the system.
- Insert the batteries with their polarities (+/- signs) aligned as indicated.
- Replace the batteries.
- Point the remote control in the direction of the system's IR sensor.

English

中文

**Meet Philips at the Internet**

**<http://www.philips.com>**

AZ 5150



## Free Manuals Download Website

<http://myh66.com>

<http://usermanuals.us>

<http://www.somanuals.com>

<http://www.4manuals.cc>

<http://www.manual-lib.com>

<http://www.404manual.com>

<http://www.luxmanual.com>

<http://aubethermostatmanual.com>

Golf course search by state

<http://golfingnear.com>

Email search by domain

<http://emailbydomain.com>

Auto manuals search

<http://auto.somanuals.com>

TV manuals search

<http://tv.somanuals.com>