

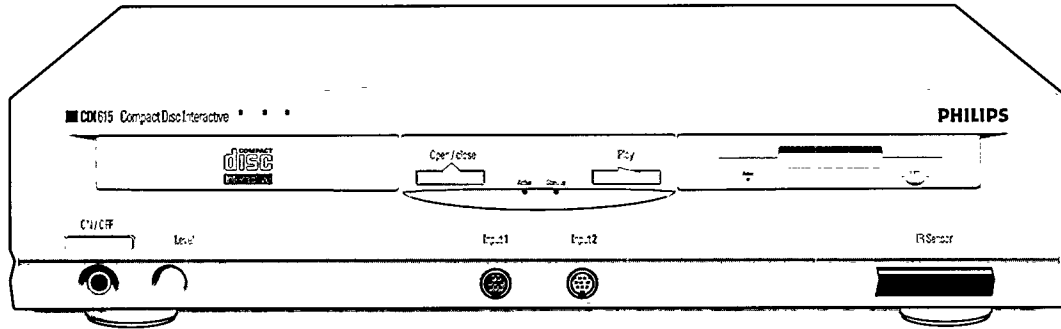

# PHILIPS



## CDI 615

**User manual**

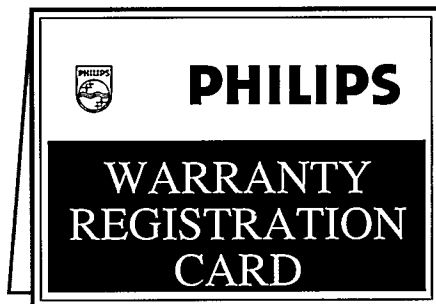

# Return your Warranty Registration Card today to ensure you receive all the benefits you're entitled.

Once your PHILIPS purchase is registered, you're eligible to receive all the privileges of owning a PHILIPS product. So complete and return the Warranty Registration Card enclosed with your purchase at once. And take advantage of these important benefits.

## ■ Warranty Verification

Registering your product within 10 days confirms your right to maximum protection under the terms and conditions of your PHILIPS warranty.

## ■ Owner Confirmation

Your completed Warranty Registration Card serves as verification of ownership in the event of product theft or loss.

## ■ Model Registration

Returning your Warranty Registration Card right away guarantees you'll receive all the information and special offers which you qualify for as the owner of your model.



# PHILIPS

**Congratulations on your purchase, and welcome to the "family!"**

**Dear PHILIPS product owner:**

Thank you for your confidence in PHILIPS. You've selected one of the best-built, best-backed products available today. And we'll do everything in our power to keep you happy with your purchase for many years to come.

As a member of the PHILIPS "family," you're entitled to protection by one of the most comprehensive warranties and outstanding service networks in the industry.

What's more, your purchase guarantees you'll receive all the information and special offers for which you qualify, plus easy access to accessories from our convenient home shopping network.

And most importantly you can count on our uncompromising commitment to your total satisfaction.

All of this is our way of saying welcome—and thanks for investing in a PHILIPS product.

Sincerely,

Robert Minkhorst  
President and Chief Executive Officer

**P.S. Remember, to get the most from your PHILIPS product, you must return your Warranty Registration Card within 10 days. So please mail it to us right now!**

**HURRY!**  
Registration Needed Within 10 Days.

### KNOW THESE SAFETY SYMBOLS.



This "bolt of lightning" indicates uninsulated material within your unit may cause an electrical shock. For the safety of everyone in your household, please do not remove product covering.

The "exclamation point" calls attention to features for which you should read the enclosed literature closely to prevent operating and maintenance problems.

**WARNING: TO PREVENT FIRE OR SHOCK HAZARD, DO NOT EXPOSE THIS EQUIPMENT TO RAIN OR MOISTURE**

**CAUTION:** To prevent electric shock, match wide blade of plug to wide slot, and fully insert.

**ATTENTION:** Pour éviter les chocs électriques, introduire la lame la plus large de la fiche dans la borne correspondante de la prise et pousser jusqu'au fond.

#### For Customer Use:

Enter below the Serial No. which is located on the rear of the cabinet. Retain this information for future reference.

Model No \_\_\_\_\_

Serial No \_\_\_\_\_

# Safety Precautions

**WARNING: TO PREVENT FIRE OR SHOCK HAZARD, DO NOT EXPOSE THIS EQUIPMENT TO RAIN OR MOISTURE.**

**CAUTION:** TO PREVENT ELECTRIC SHOCK, MATCH WIDE BLADE OF PLUG TO WIDE SLOT, FULLY INSERT.

**ATTENTION:** POUR EVITER LES CHOCS ÉLECTRIQUE, INTRODUIRE LA LAME LA PLUS LARGE DE LA FICHE DANS LA BORNE CORRESPONDANTE DE LA PRISE ET POUSSER JUSQU'AU FOND.

**LASER SAFETY:** This unit employs a laser. Only a qualified service person should remove the cover or attempt to service this device, due to possible eye injury.

**CAUTION:** USE OF CONTROLS OR ADJUSTMENTS OR PERFORMANCE OF PROCEDURES OTHER THAN THOSE SPECIFIED HEREIN MAY RESULT IN HAZARDOUS RADIATION EXPOSURE.

THIS DIGITAL APPARATUS DOES NOT EXCEED THE CLASS B LIMITS FOR RADIO NOISE EMISSIONS FROM DIGITAL APPARATUS AS SET OUT IN THE RADIO INTERFERENCE REGULATIONS OF THE CANADIAN DEPARTMENT OF COMMUNICATIONS.

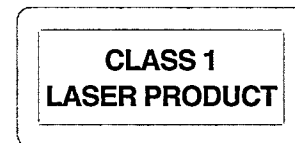

CET APPAREIL NUMÉRIQUE N'ÉMET PAS DE BRUITS RADIOÉLECTRIQUES DÉPASSANT LES LIMITES APPLICABLES DANS LA RÈGLEMENT SUR LE BROUILLAGE RADIOÉLECTRIQUES ÉDICTÉ PAR LE MINISTÈRE DES COMMUNICATIONS DU CANADA.

**NOTICE:** This device incorporates an anticopy process technology that is protected by U.S. patents and other intellectual property rights. The anticopy process is licensed for non-commercial, home use only. Reverse engineering or disassembly is prohibited.

## **WARNING:**

This device complies with Part 15 of the FCC (U.S.A.) Rules. Operation is subject to the following two conditions: (1) this device may not cause harmful interference, and (2) this device must accept any interference received, including interference that may cause undesired operation.

## **NOTE:**

This equipment has been tested and found to comply with the limits for a Class B digital device, pursuant to Part 15 of the FCC Rules. These limits are designed to provide reasonable protection against harmful interference in a residential installation! This equipment generates, uses and can radiate radio frequency energy and, if not installed and used in accordance with the instructions, may cause harmful interference to radio communications. However, there is no guarantee that interference will not occur in a particular installation. If this equipment does cause harmful interference to radio or television reception, which can be determined by turning the equipment off and on, the user is encouraged to try to correct the interference by one or more of the following measures:

- Reorient or relocate the receiving antenna.
- Increase the separation between the equipment and receiver.
- Connect the equipment into an outlet on a circuit different from that to which the receiver is connected.
- Consult the dealer or an experienced radio/TV technician for help.

## **IMPORTANT:**

This product was FCC certified under test conditions that included use of shielded cables and connectors between system components. It is important that you use shielded cables to reduce the possibility of causing interference to radios, television sets, and other electronic devices. If you have any problems, contact your dealer.

Any change or modifications to the equipment by the user not expressly approved by the grantee or manufacturer could void the user's authority to operate such equipment.

## **NOTE TO CATV SYSTEM INSTALLER:**

This reminder is provided to call the CATV (Cable-TV) system installer's attention to Article 820-40 of the NEC that provides guidelines for proper grounding and, in particular, specifies that the cable ground shall be connected to the grounding system of the building, as close to the point of cable entry as practical.

# IMPORTANT SAFETY INSTRUCTIONS

1. Read Instructions - All the safety and operating instructions should be read before the appliance is operated.
2. Retain Instructions - The safety and operating instructions should be retained for future reference.
3. Heed Warnings - All warnings on the appliance and in the operating instructions should be adhered to.
4. Follow Instructions - All operating and use instructions should be followed.

5. Cleaning - Unplug this product from the wall outlet before cleaning. Do not use liquid cleaners or aerosol cleaners. Use a damp cloth for cleaning.

Exception: A product that is meant for uninterrupted service and that for some specific reason, such as the possibility of the loss of an authorization code for a CATV converter, is not intended to be unplugged by the user for cleaning or any other purpose, may exclude the reference to unplugging the appliance in the cleaning description otherwise required in item 5.

6. Attachments - Do not use attachments not recommended by the video product manufacturer as they may cause hazards.

7. Water and Moisture - Do not use this video product near water - for example, near a bath tub, wash bowl, kitchen sink, or laundry tub, in a wet basement, or near a swimming pool, and the like.

8. Accessories - Do not place this video product on an unstable cart, stand, tripod, bracket, or table. The video product may fall, causing serious injury to a child or adult, and serious damage to the appliance. Use only with a cart, stand, tripod, bracket, or table recommended by the manufacturer, or sold with the video product. Any mounting of the appliance should follow the manufacturer's instructions, and should use a mounting accessory recommended by the manufacturer.

8A.  An appliance and cart combination should be moved with care. Quick stops, excessive force, and uneven surfaces may cause the appliance and cart combination to overturn.

9. Ventilation - Slots and openings in the cabinet are provided for ventilation and to ensure reliable operation of the video product and to protect it from overheating, and these openings must not be blocked or covered. The openings should never be blocked by placing the video product on a bed, sofa, rug, or other similar surface. This video product should never be placed near or over a radiator or heat register. This video product should not be placed in a built-in installation such as a bookcase or rack unless proper ventilation is provided or the manufacturer's instructions have been adhered to.

10. Power Sources - This video product should be operated only from the type of power source indicated on the marking label. If you are not sure of the type of power supply to your home, consult your appliance dealer or local power company. For video products intended to operate from battery power, or other sources, refer to the operating instructions.

11. Grounding or Polarization - This video product is equipped with a  polarized alternating-current line plug (a plug having one blade wider than the other). This plug will fit into the power outlet in only one way. This is a safety feature. If you are unable to insert the plug fully into the outlet, try reversing the plug. If the plug should still fail to fit, contact your electrician to replace your obsolete outlet. Do not defeat the safety purpose of the polarized plug.

12. Power-Cord Protection - Power-Supply cords should be routed so that they are not likely to be walked on or pinched by items placed upon or against them, paying particular attention to cords at plugs, convenience receptacles, and the point where they exit from the appliance.

13. Protective Attachment Plug - The appliance is equipped with an attachment plug with overload protection. This is a safety feature. See Instruction Manual for replacement or resetting of protective device. If replacement of the plug is required, be sure the service technician has used a replacement plug specified by the manufacturer that has the same overload protection as the original plug.

14. Outdoor Antenna Grounding - If an outside antenna or cable system is connected to the video product, be sure the antenna or cable system is

grounded so as to provide some protection against voltage surges and built-up static charges.

Section 810 of the National Electrical Code, ANSI/NFPA 70, provides information with regard to proper grounding of the mast and supporting structure, grounding of the lead-in wire to an antenna discharge unit, size of grounding conductors, location of antenna-discharge unit, connection to grounding electrodes, and requirements for the grounding electrode. See Fig.A.

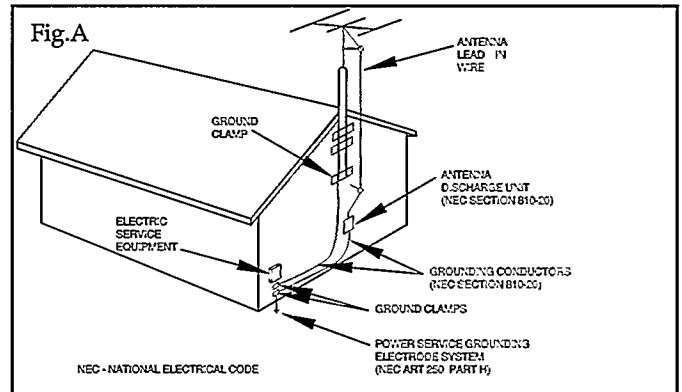

15. Lightning - For added protection for this product during a lightning storm, or when it is left unattended and unused for long periods of time, unplug it from the wall outlet and disconnect the antenna or cable system. This will prevent damage to the product due to lightning and powerline surges.

16. Power lines - An outside antenna system should not be located in the vicinity of overhead power lines or other electric light or power circuits, or where it can fall into such power lines or circuits. When installing an outside antenna system, extreme care should be taken to keep from touching such power lines or circuits as contact with them might be fatal.

17. Overloading - Do not overload wall outlets and extension cords as this can result in a risk of fire or electric shock.

18. Object and Liquid Entry - Never push objects of any kind into this product through openings as they may touch dangerous voltage points or short-out parts that could result in a fire or electric shock. Never spill liquid of any kind on the product.

19. Servicing - Do not attempt to service this product yourself, as opening or removing covers may expose you to dangerous voltage or other hazards. Refer all servicing to qualified service personnel.

20. Damage Requiring Service - Unplug this product from the wall outlet and refer servicing to qualified service personnel under the following conditions

- a. When the power-supply cord or plug is damaged.
- b. If liquid has been spilled, or objects have fallen into the product.
- c. If the product has been exposed to rain or water.
- d. If the product does not operate normally by following the operating instructions. Adjust only those controls that are covered by the operating instructions as an improper adjustment of other controls may result in damage and will often require extensive work by a qualified technician to restore the product to its normal operation.
- e. If the product has been dropped or the cabinet has been damaged.
- f. When the product exhibits a distinct change in performance - this indicates a need for service.

21. Replacement Parts - When replacement parts are required, be sure the service technician has used replacement parts specified by the manufacturer or which have the same characteristics as the original part. Unauthorized substitutions may result in fire, electric shock or other hazards.

22. Safety Check - Upon completion of any service or repairs to this product, ask the service technician to perform safety checks to determine that the product is in proper operating condition.

23. Carts and Stands - The appliance should be used only with a cart or stand that is recommended by the manufacturer.

24. Heat - The product should be situated away from heat sources such as radiators, heat registers, stoves, or other products that produce heat.

## LIMITED WARRANTY CD-i

- One (1) Year Free Labor
- One (1) Year Free Parts Service
- This CD-i must be shipped in for warranty service.

### Please keep...

...your sales receipt and other material proving proof-of-purchase. Attach it to this owner's manual and keep it nearby. Please also keep the original box and packing material should you ever need to ship your CD-i player to Philips for service.

### One (1) Year Coverage...

...starts from the date you bought your product. Both parts and labor are covered at no cost to you. Any defective part will be repaired or replaced. Any part is covered only for the original warranty period. Once the one (1) year warranty on the product has expired, the warranty on any replaced or repaired part also expires. Service for your CD-i is provided by shipping it to the Philips Factory Service Center (listed to the right) which specializes in this type of product.

After one year, you must pay for all labor, parts, transportation, and service charges.

### Who is Protected? ... Where?

Only the person who has proof-of-purchase will receive warranty service. This service will be provided to any product bought and used in the U.S.A., Puerto Rico, the Virgin Islands and Canada. If you move within these areas you must ship your monitor to the designated Philips Factory Service Center listed in this warranty.

### Before Calling for Service...

...please check your owner's manual. A check of the controls discussed there may save you a service call.

### How To Get Warranty Service

Due to the sophisticated nature of this product, warranty service will be provided by the Philips Personal Information Products Answer Center. If you feel you require warranty service for or need to discuss a problem about your CD-i, please contact the Philips Personal Information Products Answer Center at (800) 845-7301. There, a technician will go through a diagnostic check list with you and if it is determined the unit needs to be repaired, you will be given a return authorization number. Carefully pack the CD-i in secure packaging for safe shipment. It is recommended that you retain the carton and all packing materials from this unit. These materials are specifically designed and manufactured for shipping this product. Deliver or ship it freight prepaid and insured to the Philips Factory Service Center listed, with evidence of the purchase date and description of the problem. Following warranty repair, the unit will be returned to you freight prepaid. Be sure you include your complete return address on the outside of the carton.

### Warranty Exclusions - Your Warranty Does Not Cover...

...replacing or repairing your product because of misuse, accident, unauthorized repair, or other cause not within the control of Philips Consumer Electronics Company.

...incidental or consequential damages resulting from the product. Some states do not allow the exclusion of incidental damages, so the above exclusion may not apply to you.

...labor charges for installation or set-up, adjustment of customer or preference controls, and installation or repair of antenna systems outside the product.

...a product bought, used, or serviced outside the U.S.A., Puerto Rico, the Virgin Islands, and Canada.

...problems caused by signal or cable conditions outside the product.

### For product purchased in the U.S.A., Puerto Rico, or the Virgin Islands

#### How To Get Warranty Service:

If warranty service is required, you must ship your product with proof-of-purchase to a Philips Factory Service Center (listed below.)

**Philips Factory Service**  
6333 Busch Boulevard  
Columbus, OH 43229  
(614) 781-2605

IN THE U.S.A., PUERTO RICO, OR THE VIRGIN ISLANDS, ALL IMPLIED WARRANTIES INCLUDING IMPLIED WARRANTIES OF MERCHANTABILITY AND FITNESS FOR A PARTICULAR PURPOSE, ARE LIMITED IN DURATION TO THE DURATION OF THIS EXPRESS WARRANTY. Some states do not allow limitations on how long an implied warranty lasts, so the above limitation may not apply to you.

This warranty gives you specific legal rights, and you may have other rights which vary from state to state.

**Philips Service Company**  
P.I.P. Information Center  
(800) 835-3506

### For product purchased in Canada

#### How To Get Warranty Service:

To obtain warranty service, the product must be delivered (carried-in) to a Philips Consumer Service Branch (listed below). These warranties are given in lieu of all other warranties. No other guarantees or warranties are expressed or implied, including any implied warranties of merchantability or fitness for a particular purpose. Philips shall not be liable under any circumstances for any direct, indirect, special, incidental or consequential damages, howsoever incurred, even if notified of the possibility of same.

All that's required to validate your original factory warranty is to present your bill of sale as proof of purchase.

**Philips Electronics Ltd.**  
601 Milner Avenue • Scarborough, Ontario M1B 1M8 • (416) 292-5161  
4977 Levy Street • St. Lurent, Québec H4R 2N9 • (514) 956-0210  
1741 Boundary Road, • Vancouver, B.C. V5M 3Y2 • (604) 294-3441

#### IMPORTANT REMINDER:

Please fill out and mail your warranty registration card promptly. It will be easier for us to notify you if it should ever be required. Please also keep your sales receipt and other proof-of-purchase information.

Please write in your model and serial numbers below. These numbers are located on your unit. Keep this manual nearby for easy reference.

Model No.: CDI 615

Serial No.:

**For Customer Use:**

Read carefully the information located at the bottom of your CDI player and enter below the Serial N°.

Retain this information for future reference.

Model N°. CDI 615

Serial N°.

**LASER SAFETY:** This unit employs a laser. Only a qualified service person should remove the cover or attempt to service this device, due to possible eye injury.

**NEVER MAKE OR CHANGE CONNECTIONS WITH THE POWER SWITCHED ON.**

**CLASS 1  
LASER PRODUCT**

<b>SAFETY PRECAUTIONS</b> .....	3
<b>CONTENTS</b> .....	7
<b>INTRODUCTION - INSTALLATION</b> .....	8
<b>INSTALLATION</b> .....	9-11
<b>POINTING DEVICE</b> .....	12
<b>SETTING UP</b> .....	14
<b>PLAYING DISCS</b> .....	16-18
<b>GROUPWORKING</b> .....	19-20
<b>BEFORE REQUESTING SERVICE</b> .....	21
<b>SPECIFICATIONS</b> .....	22

**CAUTION**

**NEVER LEAVE A STILL PICTURE ON THE SCREEN FOR ANY LENGTH OF TIME. THIS CAN CAUSE BURNING-IN OF THE PICTURE TUBE. TO AVOID THIS, SWITCH OFF THE PLAYER OR REMOVE THE DISC.**

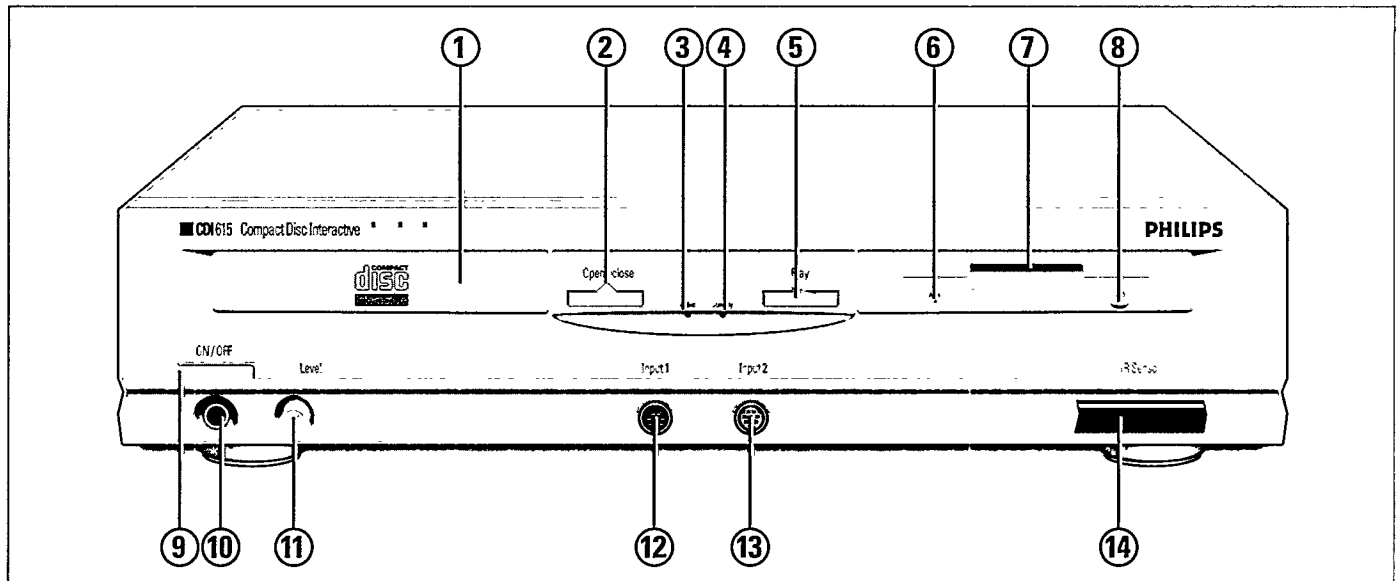

## INTRODUCTION

We are pleased to introduce you to one of the most innovative products available today: the Compact Disc Interactive player. You'll be surprised how easy it is! Once correctly hooked up to your TV, you simply 'point-and-click' to explore the intriguing new world of interactive Compact Disc.

Your CD-i player also plays CD-DA (audio compact discs) and audio tracks from CD-ROM discs. In addition it can play the following disc types: Photo CD, CD-i Ready, CD Bridge and CD Graphics (CD+G).

With the installed Digital Video Circuit, it also runs interactive Digital Video titles including movies, music videos and high-power action games as well as Video CD's.

A wide variety of optional accessories enhances the player's flexibility. Contact your supplier.

We are confident that you will find this product surprisingly easy to use, and quite unique in its fascination.

The disc types which run on this CD-i player feature one or more of these logos on the disc packaging:



## PLACEMENT

- Place the player on a firm, flat surface.
- Keep the player away from heat sources and direct sunlight.
- In a cabinet, allow 2-3 cm (approx. 1 inch) of free space all around the unit for adequate ventilation.

## FRONT OF PLAYER

- 1 Disc loading tray.
- 2 Open/close button.
- 3 'CD-i' busy indicator (green)
- 4 'On/Standby' indicator (red)
- 5 Play button.
- 6 'FDD-busy' indicator (green)
- 7 Floppy Disc Drive 3.5"
- 8 FDD eject button.
- 9 ON/OFF button.
- 10 Headphone socket.
- 11 Headphone volume control.
- 12 Pointing device input 1.
- 13 Pointing device input 2.
- 14 IR-receiver eye with 'Active' indicator (red).



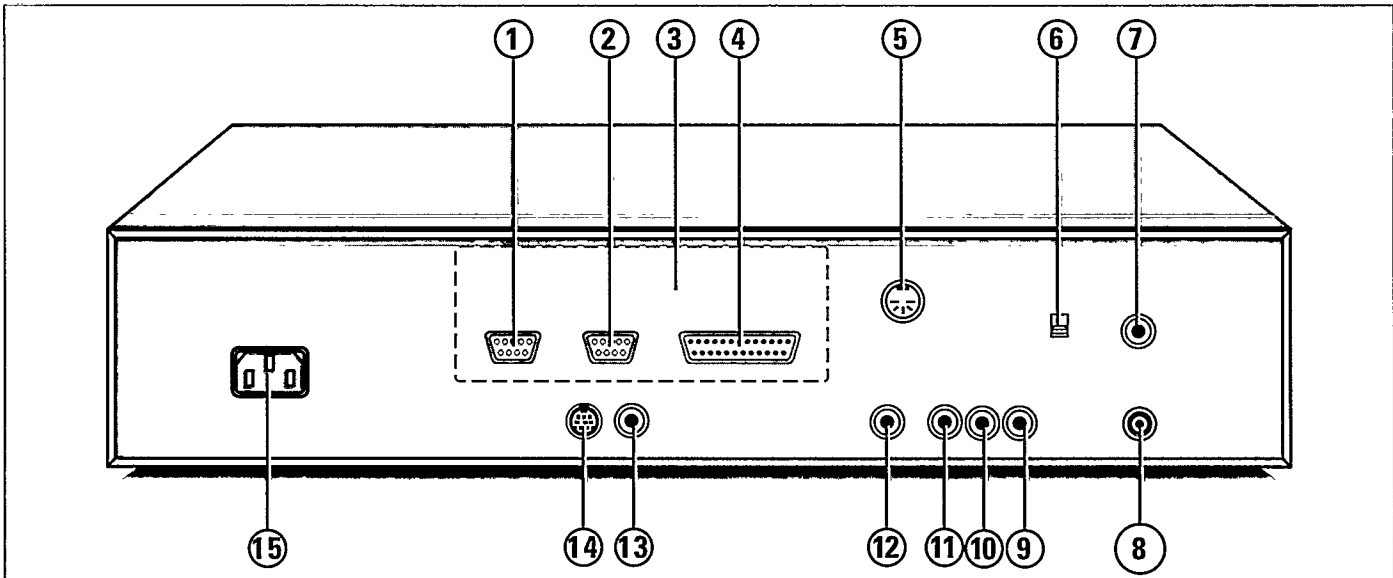

## REAR OF PLAYER

- 1 Port #1: RS232 serial port.
- 2 Port #2: RS232 serial port.
- 3 Cover plate for extension slot.
- 4 Port #3: Centronics parallel port.
- 5 Port #4: AT-keyboard connector.
- 6 Channel selector.
- 7 RF-input connector.
- 8 RF-output connector.
- 9 CVBS/Video connector.
- 10 Audio L-channel connector.
- 11 Audio R-channel connector.
- 12 Y/C (S-Video) connector.
- 13 Digital output connector.
- 14 Serial I/O port.
- 15 Power connector (AC socket).

- For any optional connection accessories you require, contact your supplier.

### CAUTION

**AVOID TO TOUCH THE INNER PINS OF CONNECTORS AT THE REAR SIDE. ELECTROSTATIC DISCHARGE MAY CAUSE PERMANENT DAMAGE TO THE PLAYER. DO NOT REMOVE PROTECTIVE CONNECTOR HOODS FROM UNUSED CONNECTORS.**

## REMOTE CONTROL

- 1 Infra red remote transmitter
- 2 Action button.
- 3 Thumbpad.
- 4 Action buttons (for left or right handed operation).
- 5 Sliding Cover.
- 6 Play button.
- 7 Pause button (CD-Audio + Video CD).
- 8 Stop button (CD-Audio + Video CD).
- 9 Volume up button.
- 10 Volume down button.
- 11 CD-i/TV button.
- 12 Next track (CD-Audio + Video CD).
- 13 Previous track (CD-Audio + Video CD).
- 14 standby.

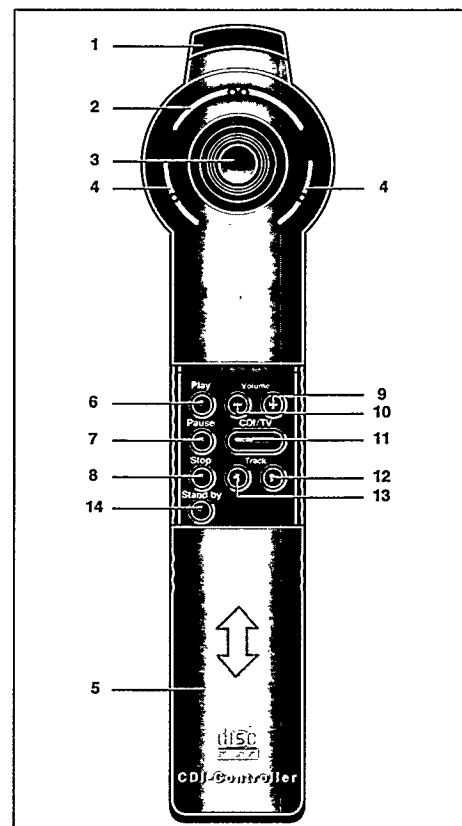

## I. CONNECTION TO A TV WITH A Y/C (S-VIDEO) SOCKET

- Just connect the corresponding connectors with the supplied Y/C cable.
- As this Y/C cable does not connect the audio, the audio has to be connected separately.

**NOTE**

- Please refer to the instructions that came with the TV set for selection of the correct input.

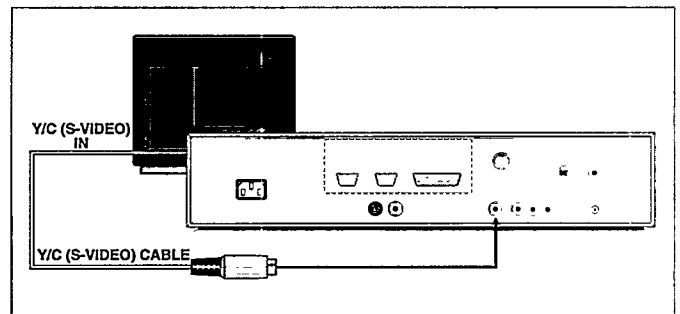

## 2. AUDIO CONNECTIONS

- If required, you can connect the player's audio output (see 10, 11 page 9) to the input of your HiFi system with an optional audio cable.

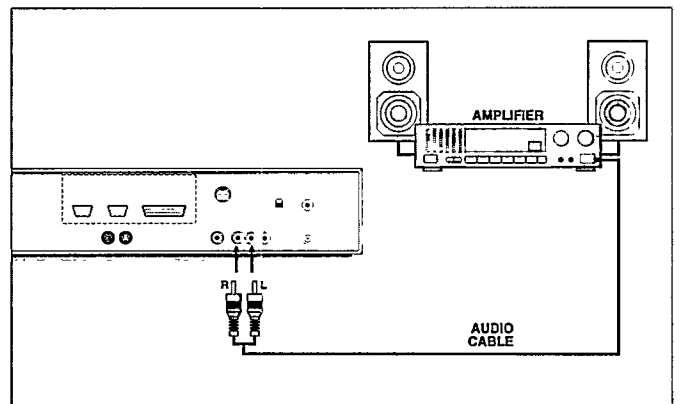

**CAUTION**

**DO NOT CONNECT THE PLAYER'S AUDIO OUTPUT (10,11) TO THE HIFI PHONO (RECORD PLAYER) INPUT.**

## 3. POWER CONNECTION

- Connect the female end of the supplied AC (alternating current) cord into the AC socket (15) at the rear.
- Insert the male end of the cord into an AC outlet.

**CAUTION**

**NEVER MAKE OR CHANGE CONNECTIONS WITH THE POWER SWITCHED ON.**

**ONLY A QUALIFIED SERVICE PERSON SHOULD REMOVE THE COVER OR ATTEMPT TO SERVICE THIS DEVICE.**

**USE OF CONTROLS OR ADJUSTMENTS OTHER THAN THOSE SPECIFIED HEREIN MAY RESULT IN HAZARDOUS RADIATION EXPOSURE OR OTHER UNSAFE CONDITION.**

**THE PLAYER AUTOMATICALLY ADJUSTS TO THE LOCAL MAINS VOLTAGE.**

**WHEN THE PLAYER IS IN "STANDBY" OR "OFF" MODE, IT IS STILL CONSUMING SOME POWER. IF YOU WISH TO DISCONNECT YOUR PLAYER COMPLETELY FROM THE POWER SOURCE, WITHDRAW THE PLUG FROM THE AC OUTLET.**

## I. CONNECTION TO A TV WITH A VIDEO (CVBS) SOCKET

- Just connect the corresponding sockets with the supplied video (CVBS) cable.
- This cable does not connect the audio, which has to be connected separately.

**NOTE**

- Please refer to the instructions that come with the TV set for selection of the correct input.

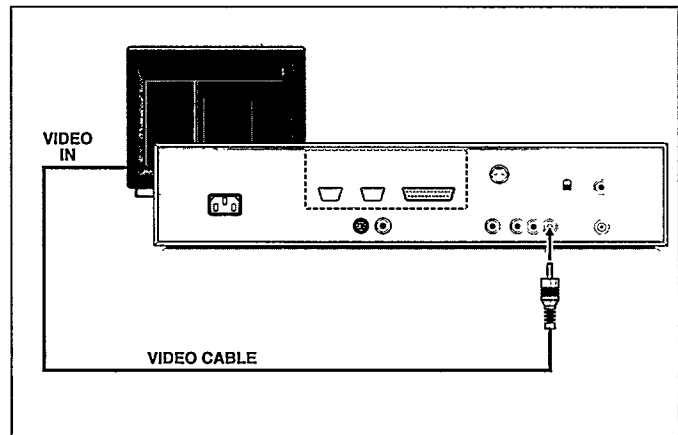

## 2. ANTENNA CONNECTIONS

- Connect the player to the TV antenna input, using the supplied antenna cable.
- If you already have a VCR (or antenna or cable TV) connected to the TV antenna input, connect the CD-i player between the VCR (or antenna or cable TV) antenna output and the TV antenna input. You may also use an optional external switchbox, if desired.
- Your CD-i player sends pictures and sound to your TV on the channel indicated on the selector switch (6) on the rear of the CD-i player. This signal is sent through the coaxial cable to the TV.
- To operate the player with your TV, tune your TV to the same channel that the selector switch is set to on the rear of the CD-i player.
- Since your CD-i player has a channel selector (6), located at the rear of the unit, you can avoid local interference by tuning to a different channel.

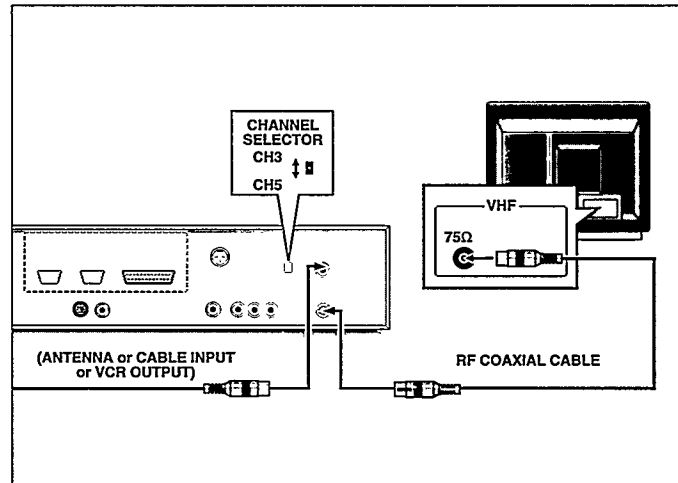

**NOTE**

- The sound sent through the RF output to your TV is *mono* only (not stereo).
- Please refer to the instructions that came with the TV-set for the selection of the proper channel.

# POINTING DEVICE

## PRECAUTIONS

To operate your CD-i player, a pointing device is needed. For pointing devices other than the remote control included, please consult your supplier.

### CAUTION

**NEVER MAKE OR CHANGE CONNECTIONS WITH THE POWER SWITCHED ON.**

Pointing devices are sensitive precision instruments. Handle them with care, keeping in mind the following precautions:

- Avoid dropping or knocking.
- Do not use them in locations subject to extreme temperatures, humidity, dust or vibration.

## INFRA RED REMOTE CONTROL

### Loading the batteries in the remote control

- Push and slide the battery compartment cover (see figure below).
- Insert three 'AA' (R6 or SUM3) batteries as indicated inside the battery compartment.
- Close the cover.

### CAUTION

**DO NOT MIX OLD AND NEW BATTERIES. ALSO NEVER MIX DIFFERENT TYPES OF BATTERIES (STANDARD, ALKALINE AND SO ON).**

### NOTE

- To save battery power, the remote control automatically switches off after approximately one minute if a button is pressed continuously. It is automatically reactivated the next time you press any button.

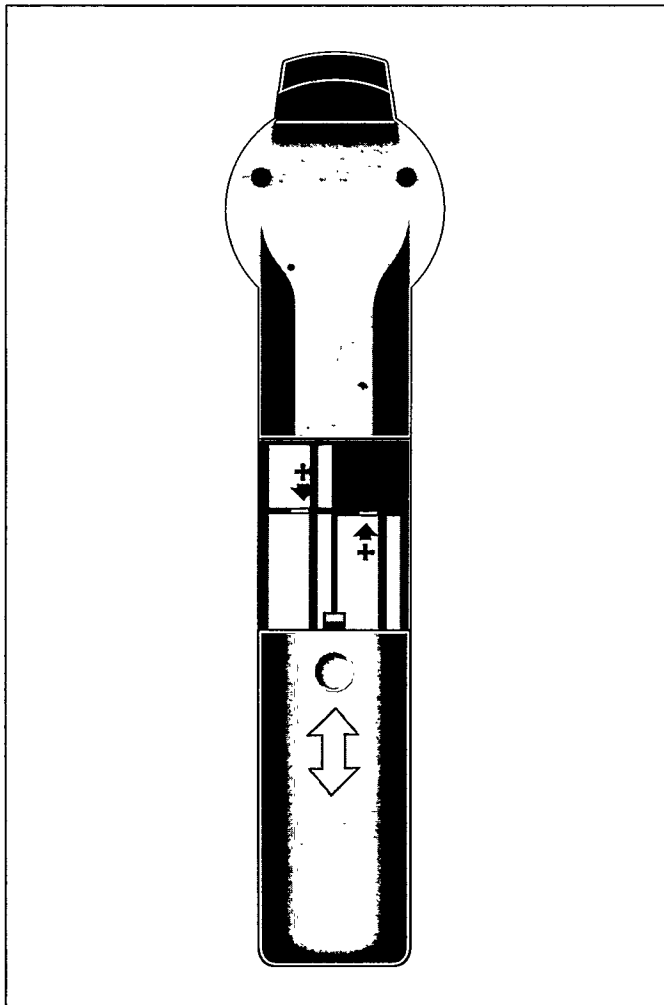

### Remote control interactive operation

For normal interactive operation, use the remote control to select functions displayed on the TV screen.

- Point the remote control at your CD-i player.
- Move the cursor in the direction you want by pressing in that direction on the "Thumbpad".
  - The harder you press the faster the cursor moves.
- Click on one of the action buttons.
  - The function selected by this 'point-and-click' technique is highlighted to confirm the selection.

### NOTE

- To 'point-and-click' on any screen shown in this manual, any one of the action buttons can be used.
- The shape of the cursor is different according to the program you are playing, but it is always controlled in the same way.

### CAUTION

**IF A WIRED CD-i CONTROLLER IS CONNECTED TO INPUT 2, THE INFRA RED REMOTE CONTROL IS INACTIVE.**

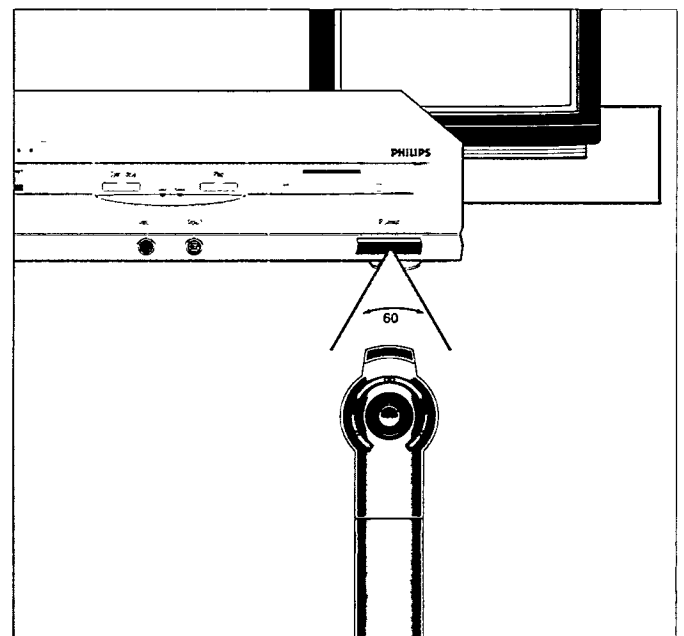

## CD-i CONTROLLER

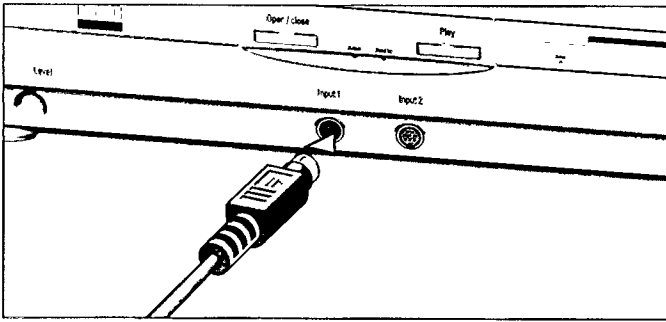

For some applications, other types of pointing devices, keyboards or controllers may be required. These CD-i controllers are defined in the CD-i Pointing Devices and Keyboards specifications, and can be connected through the CD-i I/O input 1 (12) and 2 (13) on the front of the player. Optional devices are: Roller Controller, Trackerball, Mouse, Gamepad (refer to the accessories page on the back of this manual). For further information on this subject, please contact your national Philips organization.

- Press the ON/OFF button (9) to switch the player off.
- Plug the connector of the CD-i controller into the input port (12) on the front of the player. Insert the connector with the arrow at the top.
- Switch the player on.
- Move the cursor in the direction you want.
- Click on one of the action buttons.
- The function selected by this "point-and-click" technique is highlighted to confirm the selection.

### NOTE

- To "point-and-click" on any screen shown in this manual, either one of the action buttons of the pointing device can be used.
- The shape of the cursor can be different depending on the program you are playing, but it is always controlled in the same way.
- Pointing devices are sensitive precision instruments. Handle with care, keeping in mind the following precautions:
  - Avoid dropping or knocking.
  - Do not use in locations subject to extreme temperatures, humidity, dust or vibration.
  - Never hold the pointing device by the cable.
  - Never pull the cable to disconnect the pointing device from the player.
  - When only one pointing device is used preferably, connect it to input 1 to avoid problems with the remote control.

### CAUTION

**NEVER MAKE OR CHANGE CONNECTIONS WITH THE POWER SWITCHED ON.**

## INTERFACES

### RS 232C Ports

I/O ports #1 and #2 (D-sub 9) on the rear panel can be used for general RS 232C based devices according to the application. Further information on this subject can be found in the CD-i Technical Documentation.

Depending on the application, RS 232C based devices may also be connected to CD-i I/O port #4 on the rear panel. For more information, please refer to the Technical Documentation of this CD-i player.

### Extension Slot

An extension slot provides opportunities for upgrading of system functionality and establishment of communication facilities. As functional requirements differ from one application to another, it is of no use to offer a "standard" optional extension. Instead, a tailor-made extension, on the basis of a flexible and optimal specification, will be scheduled for each project.

## SWITCHING ON AND OFF

- Press the ON/OFF button (9) to switch the player on.
  - Switch on the TV (and HiFi system if used).
  - Select the input on the TV (and HiFi system if used) to which the CD-i player has been connected.
  - Make sure the TV is tuned to the same channel as CD-i selector switch (6) is set to on back of unit.
- On the TV, the player start-up screen will appear. This screen has the following system function icons to guide and assist you:

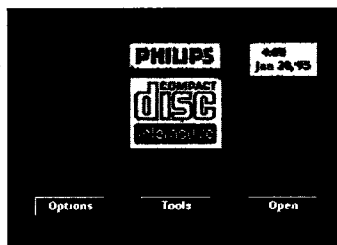

### Open/Close:

To open or close the disc tray.

### Options:

See: "OPTIONS SCREENS".

To get "Options Screens" click on "Options". To leave "Options Screens" click on "Exit".

### Tools:

See: TOOLS SCREENS

To get these Tools Screens click on "Tools". To leave the Tools Screens click on "Exit".

When finished with CD-i player:

- Press the ON/OFF button (9) to switch the player off.
- Switch off the TV (and HiFi system, if used).

## OPTIONS SCREENS

### 1. CD Audio Options

To preselect your preferred settings when playing audio CDs:

#### Auto shuffle

When the player is switched on, the tracks on the CD will automatically be played in a random order.

#### Auto FTS (Favorite Track Selection)

When the player is switched on, the FTS program of the CD will be played automatically

#### Repeat

Select to repeat a complete audio disc or a single track when the repeat function is activated.

#### Scan time

Select the time you want the beginning of each audio track to play for (5, 10 or 20 seconds) when the scan function is activated.

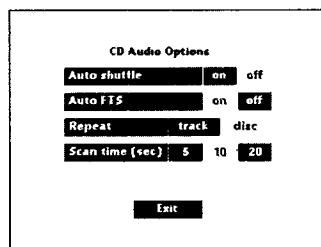

### 3. Time and Date Options

To change the player time/date settings:

#### Time/Date set

If the time or date shown on the screen is wrong, select the appropriate ▲ and ▼ arrows to set hour, minute, day, month and year in turn, as required.

#### Time format

Select 24 hour or 12 hour clock.

#### Date format

Select d/m/y to present the date in day-month-year sequence. Select m/d/y to present the date in month-day-year sequence.

#### Display time/date

Select whether time and date will be displayed on the TV screen or not.

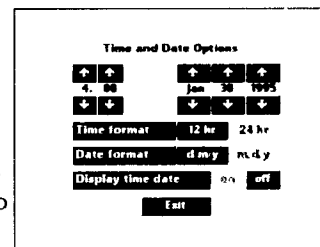

### 2. General Options

To change the player general settings:

#### Auto play

When the player is switched on, playback will start automatically when a disc is loaded and the tray is closed.

#### Volume

Selecting the player default volume setting. When the player is switched on, the player volume will rise to the preset "default" volume setting automatically.

#### 16 : 9 screen display

Selecting 16 : 9 screen display, when you have your player connected to a TV with a 16 : 9 screen.

#### standby

Select standby to enable or disable the standby function of the player (this can be done using the Remote Control button (14)).

Especially useful for groupworking environments.

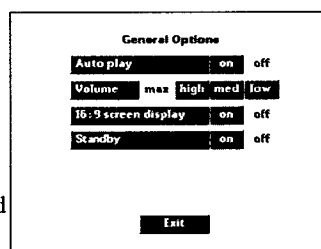

## TOOLS SCREENS

### 1. View screen

To display the contents of files held in memory or on a floppy disc:

- Click on 'Memory' or 'Floppy' to select the preferred source of files.
- To view a file, click on its title and then click on 'View'

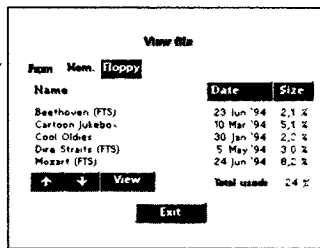

#### NOTE

Only ASCII characters will be displayed on the screen. Other characters will be displayed as blanks.

- Clicking on 'Name', 'Date' or 'Size' sorts the information accordingly.
- Use the scroll arrows to move up and down the list/contents.
- Favorite Track Selections (CD-Audio) can not be viewed.

### 3. Copy to screen

To copy files from/to the memory of the player or floppy disc and to copy (download) files to other CDI615 players (see page 19 groupworking):

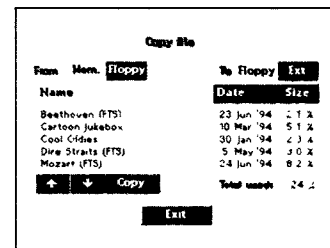

- In addition to the source, a destination also has to be specified to which the file has to be copied. Therefore, click on the preferred source and preferred destination.
- To copy a file click on the name of the preferred file and then click on 'Copy'.
- Clicking on 'Name', 'Date' or 'Size' sorts the information accordingly.
- Use the scroll arrows to move up and down the list/contents.

#### CAUTION

- **COPYING FROM MEMORY TO FLOPPY WILL CONVERT THE FILENAME TO PC FORMAT. (I.E. 8 CHARACTERS MAXIMUM AND IN CAPITALS). COPYING BACK DOES NOT RESTORE THIS.**
- **FAVORITE TRACK SELECTIONS (CD-AUDIO) CAN NOT BE COPIED.**

### 2. Delete screen

To delete a file from the memory of the player or from a floppy disc:

- Click on 'Memory' or 'Floppy' in order to select the preferred source of files.
- To delete a file click on its title and then click on 'Delete'. If you change your mind after deleting, click on 'Undo'. This is only possible on the last deleted file.
- Clicking on 'Name', 'Date' or 'Size' sorts the information accordingly.
- Use the scroll arrows to move up and down the list.

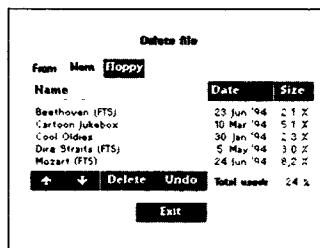

### 4. Format floppy screen

- To format a floppy disc first select the preferred floppy disc format by clicking on one of the format types.
- Then select format.

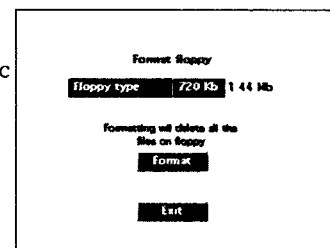

#### NOTE

After formatting of the floppy disc has begun, it cannot be cancelled.

#### NOTE

Only the root directory is displayed. Subdirectories are not displayed

#### CAUTION

**THE MAXIMUM FILE SIZE TO VIEW OR COPY IS 32 KBYTES**

# PLAYING DISCS

## GENERAL

### Push button control:

- For basic play control, or for playing discs through a stereo system without using the TV, you can use the buttons on the front panel or on the remote control.
- The PLAY and STOP buttons operate in the same way as the corresponding on-screen functions.
- PREVIOUS (TRACK) button: to return to the start of a track, select a previous track or search for a passage during playback.
- NEXT (TRACK) button: To select the next track or search for a passage during playback.

### NOTE

- The functioning of these buttons will depend completely on the application when playing a CD-i program.

## LOADING AND UNLOADING

### Loading:

- Point and click on 'Open' (you may also press the OPEN /CLOSE button **(2)** on the player) to open the disc tray **(1)**.
- Take the disc from its holder and place it on the tray with the label up.
- Point and click on 'Close' (you may also press the OPEN/CLOSE button **(2)** on the player, or gently push the front of the tray) to close the tray.
- The TV screen changes according to the type of disc being played.

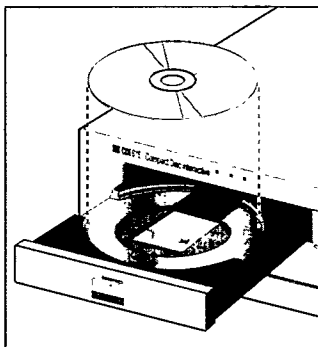

### Unloading:

- Point and click on 'Open' (you may also press the OPEN /CLOSE button **(2)** to open the disc loading tray.
- The player start-up screen reappears on the TV.
- Take the disc from the tray and replace it in its holder.
- Point and click on 'Close' (you may also press the OPEN/CLOSE button **(2)** on the player, or gently press the front of the tray) to close the tray with or without a new disc.

### NOTE

- You may unload the disc at any time by pressing the OPEN/CLOSE button **(2)**.
- Unloading a CD-i disc while the CD-i program is running, will terminate the CD-i program abruptly. 'Bookmarks' or intermediate results, if used by the CD-i program, might not be updated to the latest situation.

### CAUTION

NEVER PUT MORE THAN ONE DISC AT A TIME INTO THE CD-i PLAYER

## PLAYING A CD-i DISC

Playing a CD-i disc depends on the value of Autoplay (see Options Screens). The factory setting is default "OFF".

1. When autoplay is "OFF":  
After the disc is loaded, the CD-i start-up screen appears on the TV. To start the CD-i program, select 'Play CD-i' and click on it.
2. When autoplay is "ON":  
After the disc is loaded, the CD-i program will start up automatically.

The opening screen of the CD-i program now appears on the TV. From this point, all interaction is between you and the program. To stop at any time, select the STOP or EXIT function provided by the CD-i program.



### NOTE

- This procedure applies equally to CD BRIDGE discs, CD-i READY discs, PHOTO CDs for Digital Video discs and Video CD's.

### CAUTION

NEVER LEAVE A STILL PICTURE ON THE SCREEN FOR ANY LENGTH OF TIME. THIS CAN CAUSE BURNING-IN OF THE PICTURE TUBE. TO AVOID THIS, SWITCH OFF THE PLAYER OR REMOVE THE DISC.



## PLAYING AN AUDIO CD

### I. Using the audio screen

– After the disc is loaded, the CD-Audio screen appears on the TV.

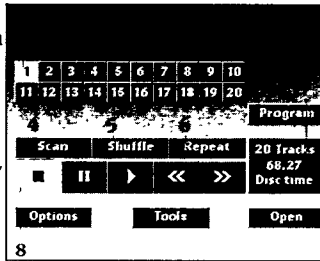

1. **Play track bar:** shows all the track numbers (up to 30). You can 'point-and-click' to select any track. For discs with more than 30 tracks, use the right > and left < scroll arrows to move through the track list.
2. **PROGRAM:** allows you to program a list of special tracks called a Favorite Track Selection. When you select PROGRAM, the FTS track bar and the FTS icon will appear.
3. **FTS:** allows you to play Favorite Track Selections. This icon only appears if a Favorite Track Selection has been created for the disc that is loaded in the player.
4. **SCAN:** allows you to listen to the beginning of every track listed in the play track bar. You can set the scan time to 5, 10 or 20 seconds in the 'Options' screen, (see p.14).
5. **SHUFFLE:** allows you to play the tracks in the play track bar in a random order.
6. **REPEAT:** allows you to repeat either a track or the entire disc. You can change the repeat mode in the 'Options' screen, (see p.14).
7. **TRACK/TIME window:**
  - in STOP mode, this shows the total number of tracks and the total playing time. When you click at this window (7), the track time of the selected track is displayed.
  - in PLAY and PAUSE modes, the window shows the track number and either the elapsed or the remaining track playing time. To change between elapsed and remaining time, 'point-and-click' at the time shown in the window.
8. All the disc play control functions are shown on the screen, and can be selected as desired by 'point-and-click' with your remote control. The operation of the functions is briefly explained in the following table.

#### NOTE

- If auto Shuffle, auto Play or auto FTS has been selected on the 'CD Audio' screen, this function will be activated automatically.
  - Sound level:
    - When playing any disc adjust the sound level as required, preferably on the TV or HiFi amplifier.
    - The volume up (9)/down (10) buttons on the remote control (see page 9) may also be used, but for each disc these controls always start at the level set in the General Options Screens (see page 14).
- A suitable level must therefore first be set on the TV or HiFi amplifier.

OPERATION	SELECT
<b>Start play</b>	<b>PLAY ▶</b> play starts at the beginning of track 1, or any other preselected track number. If a track is already playing, it is re-started.
<b>Select a track</b>	<b>TRACK NUMBER  ◀ ▶ </b> if the disc contains more than 30 tracks, use the left < and right > scroll arrows to move through the track numbers as required.
<b>Pause</b>	<b>PAUSE   </b> interrupts play.
<b>Exit pause</b>	<b>PAUSE    or PLAY ▶</b> play restarts at exactly the same point as when pause was selected.
<b>Forward search</b>	<b>FORWARD ▶▶</b> searches forward through the disc.
<b>Reverse search</b>	<b>REVERSE ◀◀</b> searches backwards through the disc.
<b>Stop play</b>	<b>STOP ■</b> stops playing. If play is re-started, it begins at the first track.
<b>Scan the disc</b>	<b>SCAN</b> plays the beginning of each track listed in the play track bar.
<b>Exit scan</b>	<b>SCAN</b> normal play starts from this point.
<b>Shuffle play</b>	<b>SHUFFLE</b> shuffle sequence appears in track bar.
<b>Exit shuffle</b>	<b>SHUFFLE</b> normal play starts from this point.
<b>Repeat</b>	<b>REPEAT</b> repeats the entire disc (or FTS program), or the track being played, as selected on the "Options" screen.
<b>Play FTS</b>	<b>FTS</b> only available when an FTS program has already been created for the disc in the player.
<b>Exit FTS</b>	<b>FTS</b> normal play starts from this point.
<b>Program FTS</b>	<b>PROGRAM</b> <ul style="list-style-type: none"> <li>• Point to tracks as required on the play track bar, and in each case click on an action button to enter the track in the FTS track bar.</li> <li>• To cancel an unwanted track, point to it in the FTS track bar and click on an action button.</li> <li>• To cancel the entire FTS program, point to the first track in the FTS track bar and click on an action button repeatedly until all the tracks disappear.</li> </ul>
<b>Store FTS</b>	<b>SAVE FTS</b> the keyboard screen replaces the CD-Audio screen. See 'CREATING FTS TITLES' ( p.18).

# PLAYING DISCS

## PLAYING AN AUDIO CD

### 2. Creating FTS titles

- At the CD-Audio screen (see p.17), 'point-and-click' on the Program button, then 'point-and-click' on the "Save FTS" (Favorite Track Selection) button.
- The keyboard screen will appear.
- Select each character of the title in turn, using Shift to change between upper and lower case characters and Space to separate words.
- Delete erases the last selected character.
- Clear erases the complete (or partially complete) title.
- Cancel returns to the CD-Audio screen without saving the title.
- Save saves the title and returns to the CD-Audio screen.

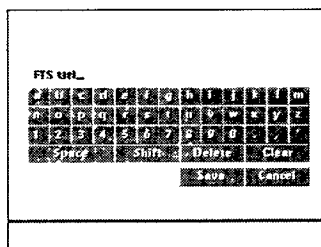

- Using the keyboard screen, you can compose a title of approx. 30 characters (depending on the character width) for the selection.
- After creating an FTS, the title then appears on the CD-Audio screen whenever the disc is loaded.

## PLAYING AN AUDIO CD

### 3. CD graphics

- When an audio CD with graphics is played, the CD Graphics screen will appear automatically.
- To make the picture channel bar appear/disappear click on the action button anywhere outside the channel bar.
- You can select another track number by clicking on 'Track' or either arrow next to it.
- Depending on the disc, other channel numbers might give you other information, such as the lyrics in a different language.
- For information about the actual graphics functions, refer to the instructions that come with the disc.
- To play audio only, click on 'Audio'.

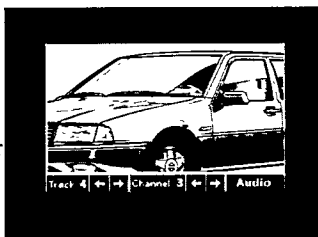

#### CAUTION

**NEVER LEAVE A STILL PICTURE ON THE SCREEN FOR ANY LENGTH OF TIME. THIS CAN CAUSE BURNING-IN OF THE PICTURE TUBE. IN SUCH A CASE SWITCH OFF THE PLAYER OR REMOVE THE DISC.**

## PLAYING A PHOTO CD

- After loading the disc, the CD-i start-up screen appears on the TV.
- To start the Photo CD program, select the 'PLAY CD-i'; you may also press the PLAY button (5) on the player or remote control (6).
- The opening screen of the Photo CD program now appears on the TV.
- At the bottom of this screen a menu bar with icons is shown.



- Select the  icon.
- The 'Options' screen will now appear.
- To select a language click on the box, the flag or the name of a country.
- The previous setting will be replaced automatically.

- Select the ↵ icon (Return) of this screen to go back to the Photo CD opening screen.

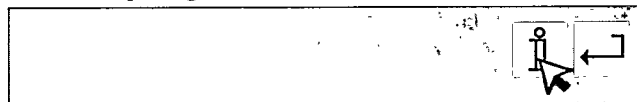

- Select the ℹ icon (Information) and the INFORMATION screen, explaining the control buttons of the menu bar in the selected language, appears.
- From this point, all interaction is between you and the program.

#### CAUTION

**NEVER LEAVE A STILL PICTURE ON THE SCREEN FOR ANY LENGTH OF TIME. THIS CAN CAUSE BURNING-IN OF THE PICTURE TUBE. IN SUCH A CASE SWITCH OFF THE PLAYER OR REMOVE THE DISC.**

## INTRODUCTION

This chapter describes the different steps which are necessary to install a linked group of CDI 615 players.

One of the CD-i players becomes 'master' player after using the download function. It remains 'master' until all players are

switched off.

It also describes the instructions for downloading a file from the central CD-i player ('master') to all connected CD-i players ('slaves').

## INSTALLATION

To operate the groupworking functionality, first follow the instructions given in the 'installation' chapter earlier in this user manual.

Before connecting the power to each individual player, connect the different players as shown in the following picture using D-sub 9 cables (for specification see Technical Documentation).

### a. Using both RS232 ports on the rear panel of the 'master' player.

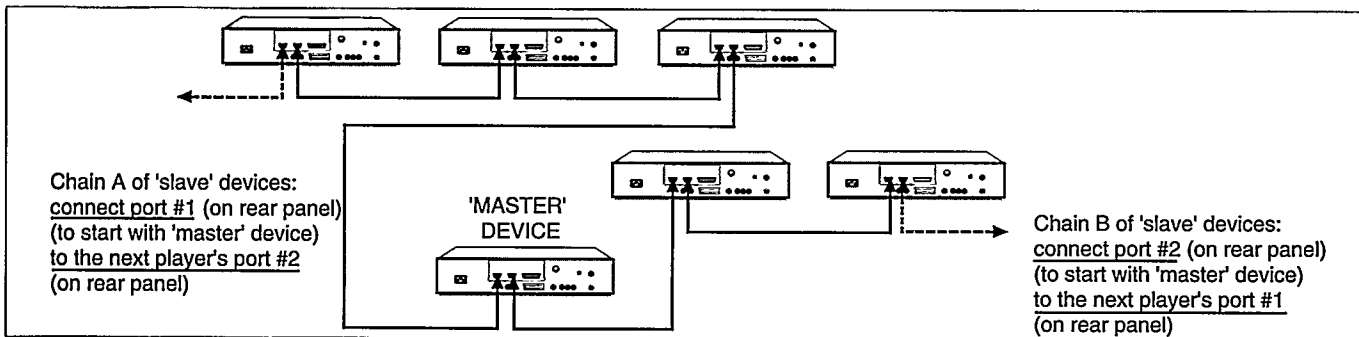

### b. Using one of the two RS232 ports on the rear panel of the 'master' player.

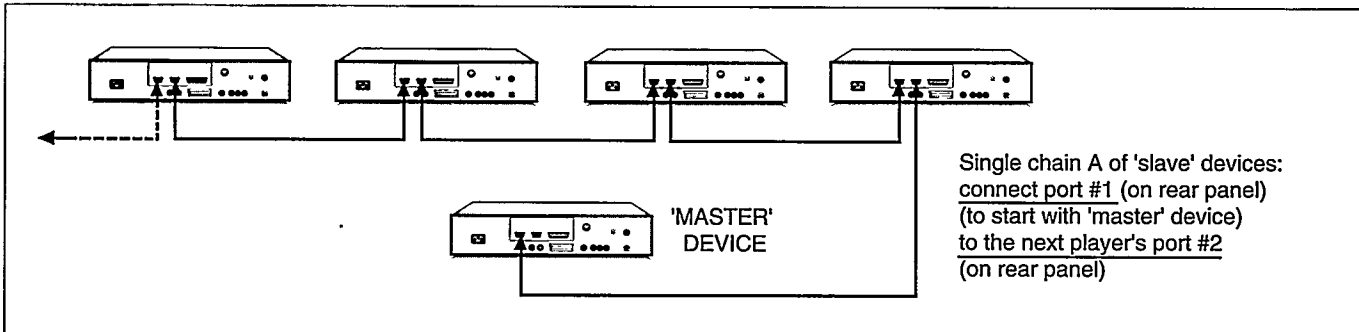

Connect each player to the power supply and switch on.

#### CAUTION

- MAKE SURE THAT DURING THE DOWNLOAD PROCEDURE ALL PLAYERS ARE IN THE START-UP SCREEN.
- IN CASE ONE OF THE PLAYERS IS NOT POWERED (E.G. IN standby POSITION OR POWER OFF) THE NETWORK WILL BE INTERRUPTED FROM THIS PLAYER ON. THE NEXT PLAYER(S) WILL NOT BE DOWNLOADED WITH THE INFORMATION OF THE MASTER'S FLOPPY.

#### NOTE

- To avoid unintentionally putting one of the players into standby mode (by pushing the standby button on the remote control), disable the standby function by selecting 'standby off' in the General Options screen. This must be done for each player which is intended to function as slave device. This step needs to be executed only once, the setting 'standby off' will remain active until 'standby on' is selected again via the same screen.

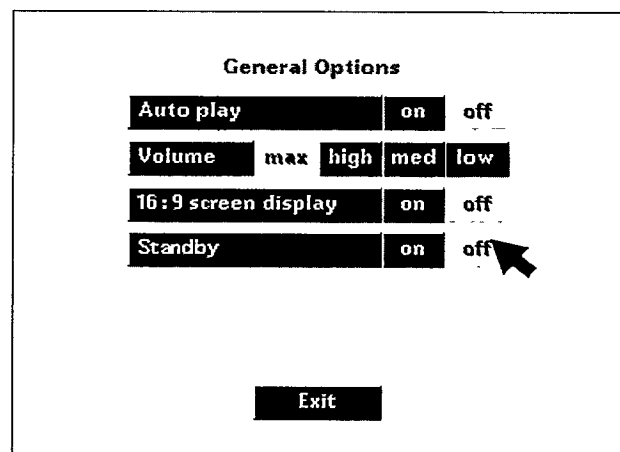

## DOWNLOADING OF FILES

- To download a file from a floppy disc to the connected players, first insert a floppy disc in the floppy disc drive of the 'master' player.  
On the Tools screen, select the Copy file screen.

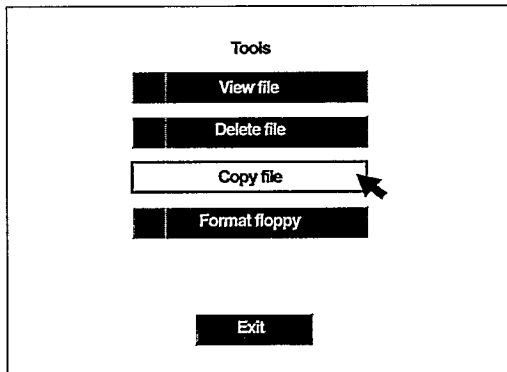

- The names of all the floppy disc files will be displayed. Select the preferred file by clicking on it.

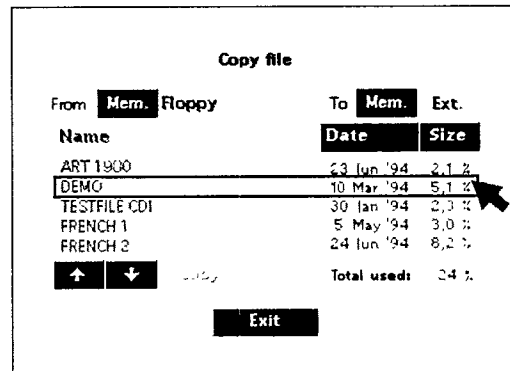

- On the Copy file screen, select the source 'Floppy'.

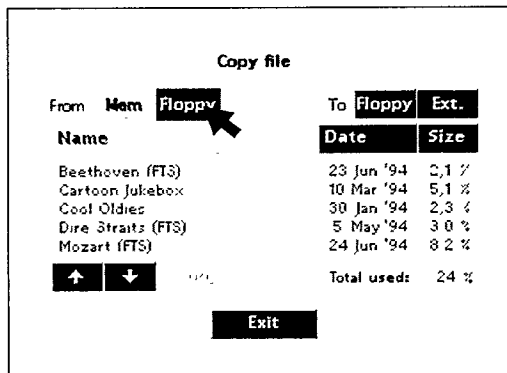

- To start downloading of the selected file, click on 'Copy' on the same screen.

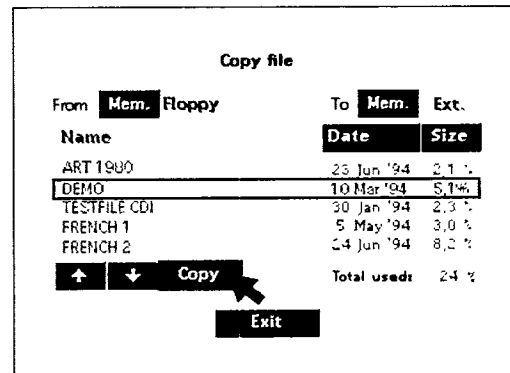

- On the Copy file screen, select the destination 'External' (Ext.).

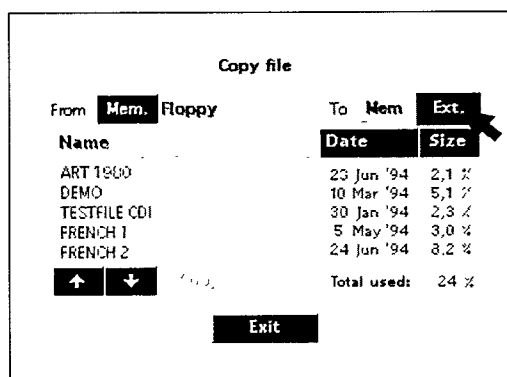

### NOTE

- It is not possible to select another function (on screen, front or remote control) during the download operation.

The file is now downloaded to the *memories* of all players which are linked to the groupwork setup.

When the download function has been completed, the total number of players to which the selected file has been downloaded will be displayed on the screen.

If this number corresponds to the total number of players connected, the download operation has been successful.

If this number does not correspond to the total number of players, the download operation was not successful. It is possible that:

- one of the connections between two players is malfunctioning. In this case, check all the connections between the different players.
- the start-up screen is not active.
- one of the CD-i players is switched off.

Before restarting the download operation again, switch all players OFF and ON.

### CAUTION

- DURING DOWNLOADING, WHEN THERE IS NOT ENOUGH MEMORY AVAILABLE IN ONE OF THE PLAYERS, THE NEEDED AMOUNT OF MEMORY WILL BE CREATED BY DELETING THE OLDEST FILE(S)**
- ONE OF THE CD-i PLAYERS BECOMES 'MASTER' PLAYER AFTER USING THE DOWNLOAD FUNCTION. IT REMAINS 'MASTER' UNTIL ALL PLAYERS ARE SWITCHED OFF. MAKE SURE ALL FOLLOWING DOWNLOAD PROCEDURES TAKE PLACE FROM THIS 'MASTER' PLAYER.**

# BEFORE REQUESTING SERVICE

If it appears that the CD-i player is faulty, first consult this check-list. It may be that something simple has been overlooked.

Under no circumstances attempt to repair the player yourself; this will invalidate the warranty.

**No power** ..... • Check that the ON/OFF button (9) on the front of the player is set to on.  
• Check that both plugs on the power cord are properly connected.  
• Check that there is power at the AC outlet by plugging in another appliance.

**No picture**..... • Check that the TV is switched on.  
• Refer to the instructions of the TV set for selection of the correct input and channel.  
• Select the same channel or input on the TV as that of the player channel selector switch (6) on rear of player.  
• Check the video connection.

**Distorted picture**..... • Check the disc for fingerprints and clean with a soft cloth, wiping from center to edge.

## The tray cannot be opened

**(no open icon on start-up screen)** ..... • Switch the player off, then switch on again while holding the PLAY button pressed.

## Disc can't be played

..... • Ensure the disc label is upwards.  
• Clean the disc.  
• Check to see if the disc is defective by trying another disc.

**No sound**..... • Check audio connections.  
• If using a HiFi amplifier, try another sound source.

## Distorted sound

**from HiFi amplifier** ..... • Check to make sure that audio connections are not made to amplifier Phono input.

## No return to start-up screen when disc is removed

..... • Reset by switching the player off, then on again.  
• Check to see if the CD-i program requires another disc to be loaded.

## The player can't be remote controlled

..... • Aim the remote control directly at the sensor on the front of the player (14).  
• Avoid all obstacles which may interfere with the signal path.  
• Inspect or replace the batteries.  
• Check that no pointing device is connected to input 2.

## The player can't be controlled

**(While using a wired CD-i controller)** ..... • Check the CD-i controller connection.  
• Switch the player off, then switch on again.

## Copy to other CDI 615 players failed

### (error message or displayed number of ...

**players does not correspond with linked number of players)** • Make sure all players are connected correctly (see chapter groupworking installation, page 19).  
• Check that all players display the start-up screen.  
• Check to make sure that all players are switched on.  
• Make sure there is no other 'master' player.

## Copy to floppy failed ...

..... • Check that the floppy is formatted (PC type format)  
• Check that the floppy is not write protected.  
• Check that there is enough disc space available for the file.  
• Make sure that the same file is not already on floppy with write protection on.

## Copy to memory failed

..... • Check that there is enough memory space available for the file.  
• Make sure that the size of the file is smaller than 32Kbytes.

## View failed after selecting next page

..... • Check that the file is smaller than 32Kbytes.

## Delete of floppy file failed

..... • Check that the floppy is still in the disc drive.  
• Check that the floppy is not write protected.  
• Make sure that the file is not write protected.

## Format floppy failed

..... • Check that the floppy is not write protected.  
• Make sure that the floppy type is equal to the type selected in the format menu.



# SPECIFICATIONS

For more information refer to the supplied Technical Documentation

## System

CD-Interactive

## Usable discs

CD-i	VIDEO CD
CD-DA	CD DIGITAL
PHOTO-CD	
CD-i READY	
CD BRIDGE	
CD+GRAPHICS	

## Power requirement

120VAC 50/60Hz

## Power consumption

23W approx

## Operating temperature

41°F(5°C) to 95°F(35°C)

## Relative humidity

5% to 95% (no condensation)

## Weight

4,200 kg approx

## Dimensions (w x h x d)

435 mm x 105 mm x 280 mm  
17 1/8 x 4 1/8 x 11"

## Connections

### AT-keyboard Din connector (rear)

pin	signal
1	clock
2	data
3	n.c.
4	GND
5	+5V (300 mA max)
levels	TTL

### Digital out (rear)

0,5 Vpp into 75 ohm  
RCA pin cinch socket

### Y/C (S-video) (rear)

mini-DIN 4-pin pin	signal
1	GND
2	GND
3	Y (1Vpp into 75 ohm)
4	C (burst 300mVpp into 75 ohm)

### RF I/O

Connector F-type  
Antenna Input 75 ohm unbal  
out to TV 75 ohm unbal with  
\*CD-i RF out to TV = 66 dBv  
\* antenna RF out to TV = loop through (CD-i power off)  
Channel selector ch3=61.250 MHz  
ch4=67.250 MHz

### serial I/O (rear) (1 ports) 8-pin mini-DIN

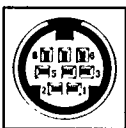

pin	signal	I/O
1	nc	-
2	rxd	I
3	txd	O
4	nc	-
5	ground	-
6	cts	I
7	rts	O
8	+5V (100 mA max)	

Serial communication at 9600 baud.

### RS232 Serial Port #1, #2 (rear)

2 connectors DB9 male  
Signals according EIA RS232 - E standard and CCITT V.28  
Baudrates up to 115200 baud are supported .

pin	signal	I/O
1	DCD	I
2	RXD	I
3	TXD	O
4	DTR	O
5	GND	-
6	DSR	I
7	RTS	O
8	CTS	I
9	RI	I
levels	RS standard	

### Centronics parallel port #3 (rear)

25 pin sub D connector female  
standard centronics interface / ECP / EPP for printers  
and general purpose parallel I/O.

pin	signal	I/O	pin	signal	I/O
1	STROBE*	O	14	AOTOFDXT*	O
2	D0	I/O	15	ERROR*	I
3	D1	I/O	16	INIT* (reset)	O
4	D2	I/O	17	SEL* (select in)	O
5	D3	I/O	18	GROUND	-
6	D4	I/O	19	GROUND	-
7	D5	I/O	20	GROUND	-
8	D6	I/O	21	GROUND	-
9	D7	I/O	22	GROUND	-
10	ACK*	I	23	GROUND	-
11	BUSY	I	24	GROUND	-
12	PE (paper empty)	I	25	GROUND	-
13	SEL (on-line)	I			

\* Low = active  
Levels TTL

### Pointing device input 1 and input 2 (front)

(2 ports) 8-pin mini-DIN

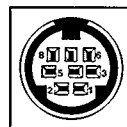

#### mini-DIN input 1

pin	signal	I/O
1	n.c.	-
2	rxd2	I
3	txd2	-
4	n.c.	-
5	gnd	-
6	n.c.	-
7	rts2	O
8	+5V (100 mA max)	O
levels	TTL	

#### mini-DIN input 2

pin	signal	I/O
1	n.c.	-
2	rxd1	I
3	n.c.	O
4	n.c.	-
5	gnd	-
6	n.c.	-
7	rts1	O
8	+5V (100 mA max)	O
levels	TTL	

Pointing device speed of 1200 baud is supported.

### Audio out

2 Vrms  
2 channel individual RCA pin cinch sockets

### video out (NTSC)

1 Vpp (75 Ohm load, sync neg) RCA pin jack

### Headphone

Socket for 6.3 mm stereo jack  
8-2000 ohm  
30mw @ 32 ohm

Designs and specifications are subject to change without notice.

# ACCESSORIES • ACCESSOIRES

## SUPPLIED ACCESSORIES • ACCESSOIRES FOURNIS

These accessories are provided to help you use or set-up your CD-i Player.

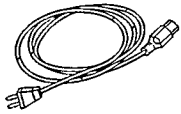

AC Cord

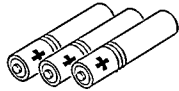

Three Batteries R6



"Thumbpad"  
Remote Control  
Handset

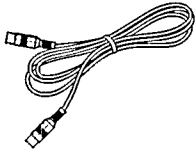

Antenna Cable  
(RF coaxial cable)

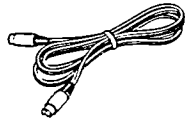

Y/C Cable

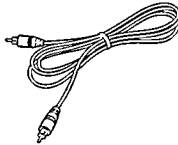

Video (CVBS)  
Cable

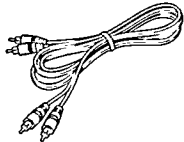

Audio L-R Cable

## OPTIONAL ACCESSORIES • ACCESSOIRES EN OPTION

Maximize your pleasure with state-of-the-art accessories designed specifically for your CD-i Player.

The optional accessories shown here may be purchased from your supplier.

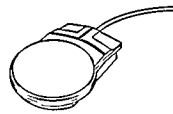

CD-i Mouse  
22ER9011



Roller Controller  
22ER9012

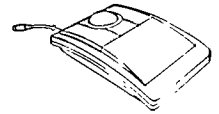

CD-i Trackerball  
22ER9013

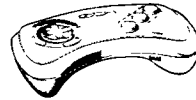

Gamepad  
22ER9021

type no. of product • Numéro de série du produit

CDI 615

Date of purchase

day • Jour month • Mois year • Année 19

Dealer's name, address and signature

The products and services described herein are not necessarily available in all countries.

Due to continuous product improvements this document is subject to change without notice

©1995 PHILIPS INTERACTIVE MEDIA SYSTEMS

Printed in Belgium. 3104 125 21591  
IB7458E001



## Free Manuals Download Website

<http://myh66.com>

<http://usermanuals.us>

<http://www.somanuals.com>

<http://www.4manuals.cc>

<http://www.manual-lib.com>

<http://www.404manual.com>

<http://www.luxmanual.com>

<http://aubethermostatmanual.com>

Golf course search by state

<http://golfingnear.com>

Email search by domain

<http://emailbydomain.com>

Auto manuals search

<http://auto.somanuals.com>

TV manuals search

<http://tv.somanuals.com>