

PHILIPS

CDR 765 CD Recorder/Player

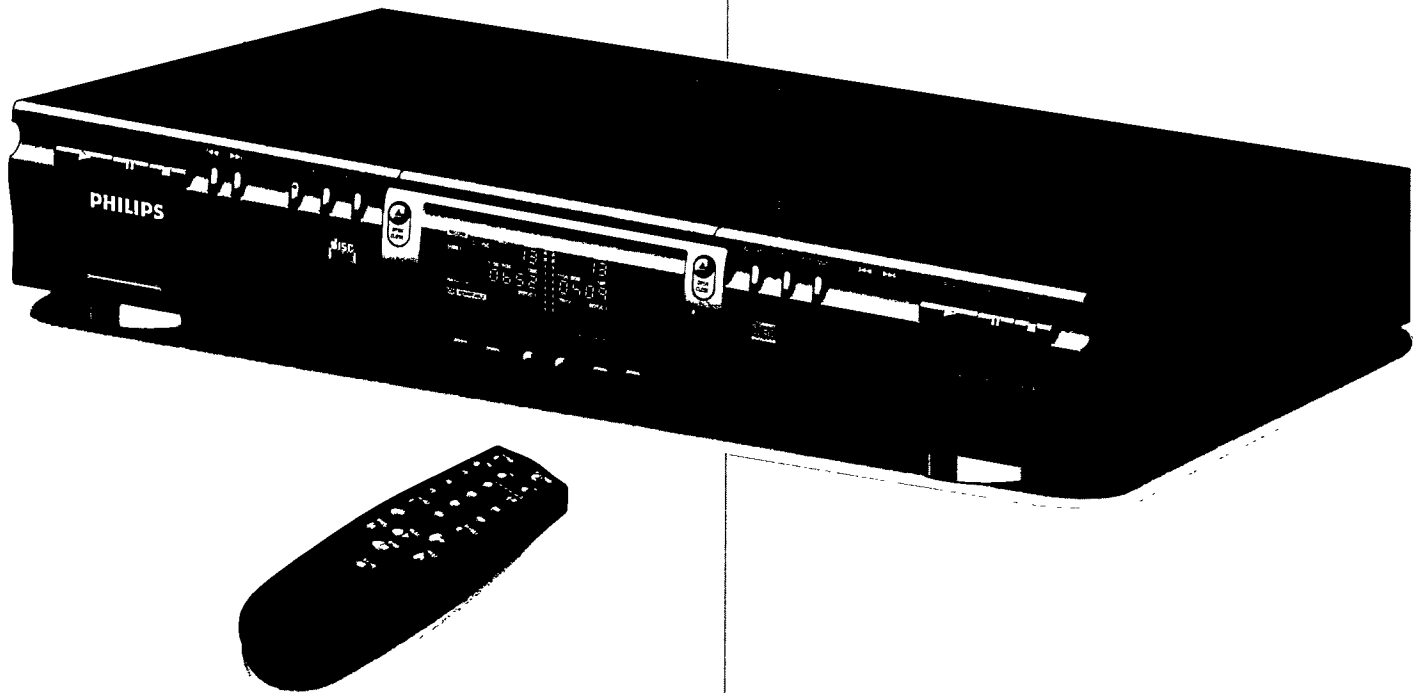

Instructions for use



Mode d'emploi

Instrucciones de manejo





PHILIPS

IMPORTANT SAFETY INSTRUCTIONS

1. Read Instructions - All the safety and operating instructions should be read before the appliance is operated.
2. Retain Instructions - The safety and operating instructions should be retained for future reference.
3. Heed Warnings - All warnings on the appliance and in the operating instructions should be adhered to.
4. Follow Instructions - All operating and use instructions should be followed.
5. Water and Moisture - The appliance should not be used near water - for example, near a bathtub, washbowl, kitchen sink, laundry tub, in a wet basement, or near a swimming pool, and the like.
6. Carts and Stands - The appliance should be used only with a cart or stand that is recommended by the manufacturer.
- 6A.  An appliance and cart combination should be moved with care. Quick stops, excessive force, and uneven surfaces may cause the appliance and cart combination to overturn.
7. Wall or Ceiling Mounting - The appliance should be mounted to a wall or ceiling only as recommended by the manufacturer.
8. Ventilation - The appliance should be situated so that its location or position does not interfere with its proper ventilation. For example, the appliance should not be situated on a bed, sofa, rug, or similar surface that may block the ventilation openings; or, placed in a built-in installation, such as a bookcase or cabinet that may impede the flow of air through the ventilation openings.
9. Heat - The appliance should be situated away from heat sources such as radiators, heat registers, stoves, or other appliances (including amplifiers) that produce heat.
10. Power Sources - The appliance should be connected to a power supply only of the type described in the operation instructions or as marked on the appliance.
11. Grounding or Polarization - The precautions that should be taken so that the grounding or polarization means of an appliance is not defeated. 
12. Power-Cord Protection - Power-Supply cords should be routed so that they are not likely to be walked on or pinched by items placed upon or against them, paying particular attention to cords at plugs, convenience receptacles, and the point where they exit from the appliance.
13. Cleaning - The appliance should be cleaned only as recommended by the manufacturer.
14. Nonuse Periods - The power cord of the appliance should be unplugged from the outlet when left unused for a long period of time.
15. Object and Liquid Entry - Care should be taken so that objects do not fall and liquids are not spilled into the enclosure through openings.
16. Damage Requiring Service - The appliance should be serviced by qualified service personnel when :
 - a. The power-supply cord or plug has been damaged; or
 - b. Objects have fallen, or liquid has been spilled into the appliance; or
 - c. The appliance has been exposed to rain ; or
 - d. The appliance does not appear to operate normally or exhibits a marked change in performance; or
 - e. The appliance has been dropped, or the enclosure damaged.
- 17 Servicing - The user should not attempt to service the appliance beyond that described in the operating instructions. All other servicing should be referred to qualified service personnel.

WARNING

**TO REDUCE THE RISK OF FIRE OR ELECTRIC SHOCK ,
DO NOT EXPOSE THIS APPLIANCE TO RAIN OR MOISTURE.**

	CAUTION RISK OF ELECTRIC SHOCK DO NOT OPEN	
CAUTION: TO REDUCE THE RISK OF ELECTRIC SHOCK, DO NOT REMOVE COVER (OR BACK). NO USER-SERVICEABLE PARTS INSIDE. REFER SERVICING TO QUALIFIED SERVICE PERSONNEL.		

 The lightning flash with arrowhead symbol, within an equilateral triangle, is intended to alert the user to the presence of uninsulated "dangerous voltage" within the product's enclosure that may be of sufficient magnitude to constitute a risk of electric shock to persons.

 The exclamation point within an equilateral triangle is intended to alert the user to the presence of important operating and maintenance (servicing) instructions in the literature accompanying the appliance.

GENERAL INFORMATION

CAUTION
USE OF CONTROLS OR ADJUSTMENTS OR PERFORMANCE OF PROCEDURES OTHER THAN THOSE SPECIFIED HEREIN MAY RESULT IN HAZARDOUS RADIATION EXPOSURE.

The set complies with the FCC-Rules, Part 15 and with 21 CFR 1040.1

CAUTION
TO PREVENT ELECTRIC SHOCK, MATCH WIDE BLADE OF PLUG TO WIDE SLOT, FULLY INSERTED.

ATTENTION
POUR EVITER LES CHOCS ELECTRIQUES, INTRODUIRE LA LAME LA PLUS LARGE DE LA FICHE DANS LA BORNE CORRESPONDANTE DE LA PRISE ET POUSSER JUSQU'AU FOND.

CDN Canada

This digital apparatus does not exceed the Class B limits for radio noise emissions from digital apparatus as set out in the Radio Interference Regulations of the Canadian Department of Communications.

Cet appareil numérique n'émet pas de bruits radioélectriques dépassant les limites applicables dans la règlement sur le brouillage radioélectriques édicté par le ministère des communications du Canada.

LASER

Type	Semiconductor laser GaAlAs
Wave length	775-795 nm (at 25°C)
Output Power	2,5 mW (Read) 35 mW (Write)
Beam divergence	60 degree

This warning label is located on the rearside and inside this laser product.

CAUTION: INVISIBLE LASER RADIATION
 WHEN OPEN, DO NOT STARE INTO BEAM
DANGER: INVISIBLE LASER RADIATION WHEN OPEN.
 AVOID DIRECT EXPOSURE TO BEAM.
VARO! AVAITAESSA JA SUOJALUKITUS OHITETTAESSA OLET
 ALTINANAKYMATTOMAA LLE LASERSATELYLLE ALA
 KATSO SATEESEEN
WARNING! OSYNI GLASERSTRÄLNINGNÄR DENNA DEL ÄR ÖPPNAD
 OCH SPARREN ÄR URKOPPLAD. BETRÄKTA EJ STRÅLEN

OR

**DANGER - Invisible laser radiation when open.
 AVOID DIRECT EXPOSURE TO BEAM**

THIS DEVICE COMPLIES WITH PART 15 OF THE FCC (U.S.A.) RULES. OPERATION IS SUBJECT TO THE FOLLOWING TWO CONDITIONS : (1) THIS DEVICE MAY NOT CAUSE HARMFUL INTERFERENCE, AND (2) THIS DEVICE MUST ACCEPT ANY INTERFERENCE RECEIVED, INCLUDING INTERFERENCE THAT MAY CAUSE UNDESIRED OPERATION.

NOTE

This equipment has been tested and found to comply with the limits for a Class B digital device, pursuant to part 15 of the FCC Rules. These limits are designed to provide reasonable protection against harmful interference in a residential installation. This equipment generates, uses and can be used in accordance with the instructions, may cause harmful interference to radio communications. However, there is no guarantee that interference will not occur in a particular installation.

If this equipment does cause harmful interference to radio or television reception, which can be determined by turning this equipment off and on, the user is encouraged to try to correct the interference by one or more of the following measures :

- reorient or relocate the receiving antenna.
- increase the separation between the equipment and receiver.
- connect the equipment into an outlet on a circuit different from that to which the receiver is connected.
- consult the dealer or an experienced radio/TV technician for help.

IMPORTANT

THIS PRODUCT WAS FCC VERIFIED UNDER TEST CONDITIONS THAT INCLUDED USE OF SHIELDED CABLES AND CONNECTORS BETWEEN SYSTEM COMPONENTS. IT IS IMPORTANT THAT YOU USE SHIELDED CABLES TO REDUCE THE POSSIBILITY OF CAUSING INTERFERENCE TO RADIOS, TELEVISION SETS AND OTHER ELECTRONIC DEVICES. IF YOU HAVE ANY PROBLEMS CONTACT YOUR DEALER.

ANY CHANGE OR MODIFICATIONS TO THE EQUIPMENT BY THE USER NOT EXPRESSLY APPROVED BY THE GRANTEE OR MANUFACTURER COULD VOID THE USER'S AUTHORITY TO OPERATE SUCH EQUIPMENT.

LIMITED WARRANTY

CD-R RECORDER/PLAYER

90 Days Free Labor

One Year Exchange Warranty on Parts

This product must be carried in for repair.

WHO IS COVERED?

You must have proof of purchase to receive warranty service. A sales receipt or other document showing that you purchased the product is considered proof of purchase.

WHAT IS COVERED?

Warranty coverage begins the day you buy your product. For 90 days thereafter, all parts will be repaired or replaced, and labor is free. From 90 days to one year from the day of purchase, all parts will be repaired or replaced, but you pay for all labor charges. After one year from the day of purchase, you pay for the replacement or repair of all parts, and for all labor charges.

All parts, including repaired and replaced parts, are covered only for the original warranty period. When the warranty on the product expires, the warranty on all replaced and repaired parts also expires.

WHAT IS EXCLUDED?

Your warranty does not cover:

- labor charges for installation or setup of the product, adjustment of customer controls on the product, and installation or repair of antenna systems outside of the product.
- product repair and/or part replacement because of misuse, accident, unauthorized repair or other cause not within the control of Philips Consumer Electronics Company.
- reception problems caused by signal conditions or cable or antenna systems outside the unit.
- a product that requires modification or adaptation to enable it to operate in any country other than the country for which it was designed, manufactured, approved and/or authorized, or repair of products damaged by these modifications.
- incidental or consequential damages resulting from the product. (Some states do not allow the exclusion of incidental or consequential damages, so the above exclusion may not apply to you. This includes, but is not limited to, prerecorded material, whether copyrighted or not copyrighted.)
- a product that is used for commercial or institutional purposes (including but not limited to rental purposes).

WHERE IS SERVICE AVAILABLE?

Warranty service is available in all countries where the product is officially distributed by Philips Consumer Electronics Company. In countries where Philips Consumer Electronics Company does not distribute the product, the local Philips service organization will attempt to provide service (although there may be a delay if the appropriate spare parts and technical manual(s) are not readily available).

MAKE SURE YOU KEEP ...

Please keep your sales receipt or other document showing proof of purchase. Attach it to this owner's manual and keep both nearby. Also keep the original box and packing material in case you need to return your product.

BEFORE REQUESTING SERVICE...

Please check your owner's manual before requesting service. Adjustments of the controls discussed there may save you a service call.

TO GET WARRANTY SERVICE IN U.S.A., PUERTO RICO OR U.S. VIRGIN ISLANDS...

Take the product to a Philips factory service center (see enclosed list) or authorized service center for repair. When the product has been repaired, you must pick up the unit at the center. Centers may keep defective parts.

(In U.S.A., Puerto Rico and U.S. Virgin Islands, all implied warranties, including implied warranties of merchantability and fitness for a particular purpose, are limited in duration to the duration of this express warranty. Because some states do not allow limitations on how long an implied warranty may last, this limitation may not apply to you.)

TO GET WARRANTY SERVICE IN CANADA...

Take the product to a Philips consumer service center (listed below), self-servicing dealer or authorized service depot.

Philips Electronics Ltd.
601 Milner Avenue, Scarborough, Ontario, M1B 1M8
(416) 292-5161
4977 Levy Street, St. Laurent Québec, H4R 2N9
(514) 956-0120
1741 Boundary Road, Vancouver, B.C. V5M 3Y7
(604) 294-3441

(In Canada, this warranty is given in lieu of all other warranties. No other warranties are expressed or implied, including any implied warranties of merchantability or fitness for a particular purpose. Philips is not liable under any circumstances for any direct, indirect, special, incidental or consequential damages, howsoever incurred, even if notified of the possibility of such damages.)

REMEMBER...

Please record the model and serial numbers found on the product below. Also, please fill out and mail your warranty registration card promptly. It will be easier for us to notify you if necessary.

MODEL # _____

SERIAL # _____

This warranty gives you specific legal rights. You may have other rights which vary from state/province to state/province.

Philips Service Company, P.O. Box 555, Jefferson City, Tennessee 37760, (423) 475-8869

EL6191E001 / MAC 6058 / 10-96

IB7922E001

CONTENTS

English	4	English
Français.....	22	Français
Español	40	Español

GENERAL INFORMATION

Table of contents

GENERAL INFORMATION

Technical information.....	4
Disc for recording.....	5
Discs for playback.....	5
Maintenance.....	5
Accessories.....	5

OPERATING BUTTONS AND CONNECTIONS

Operating buttons on the front.....	6
Connections on the back.....	6

DISPLAY

DISPLAY explanation.....	7
DISPLAY messages.....	8

INSTALLATION

Connections general.....	9
Analogue connections CD Recorder & CD Player.....	9
Analogue connections CD Player deck.....	10
Digital coaxial connections CD Recorder.....	10
Digital optical connections CD Recorder.....	11
Power supply.....	11
Set-up recommendations.....	11
Inserting batteries in the remote control.....	11

REMOTE CONTROL & INSERTING DISCS

Remote control commands.....	12
Inserting discs.....	12

RECORDING

Remarks about recording.....	13
Normal and high-speed dubbing.....	13
Digital recording from external CD player.....	14
Synchronized digital recording from external CD player: CD-SYNC.....	15
Analogue recording from an external source.....	16
Finalizing CD-R & CD-RW discs.....	17
Unfinalizing CD-RW discs.....	17

ERASING & PLAYING

Erasing CD-RW discs.....	18
Playing CDs on deck 1 and/or deck 2.....	18
Playing as a 2-disc changer.....	18

PLAYING

Selecting a track or searching.....	19
Shuffle (random-order) play.....	19
Repeat CD, track or program.....	19
Programming.....	20

FIXING PROBLEMS

Troubleshooting.....	21
Diagnostic program.....	21

Welcome !

Thank you for purchasing this Philips Compact Disc Recorder/Player Double Deck.

In the 1980s Philips invented a new audio system - the CD. The CD (compact disc) revealed the new dimensions of digital sounds and enhanced the pleasures of audio.

Compact disc technology permits a high contrast in both loud and quiet passages, with perfect channel separation. Philips has continued to develop compact disc technology and the result is the CD recorder.

With your Philips CD Recorder/Player you can make your own, high-quality audio CDs, subject only to the legal restrictions on copying. You can either dub at high or normal speed from the Player to the Recorder or record from an external source. Naturally all pre-recorded audio CDs can be combined CDs - e.g. CD-Extra - can be played using one or both of the decks individually or together as a double-deck changer.

Recordings may only be made for personal use. It is forbidden to copy material protected by copyright, including computer programs, films, television and audio recordings. This appliance may not be used for such applications.

Technical information

Subject to modification without notice.

Digital frequency response.....	0-22,050Hz
Playback S/N.....	100dB
Playback dynamic range.....	95dB
Play back total harmonic distortion.....	0.0056%, -85dB
Recording S/N (Analogue).....	90dB
Recording S/N (Digital).....	Equal to source
Recording dynamic range.....	92dB
Recording total harmonic distortion.....	0.0056%, -85dB

Digital coaxial input (IEC 958).....	44.1 kHz +/-100ppm
Digital optical input (IEC958).....	44.1 kHz +/- 100ppm
Analogue input (4 steps -3, 0, 3 and 6 dB).....	500 mVrms/50kΩ=0dB
Audio output.....	2V RMS ±2dB
Digital coaxial output.....	0.5 Vpp/75Ω
Headphones.....	0-5V RMS/8-2000Ω

Dimensions.....	17 1/8 x 12 x 35 5/8 inches
Weight.....	4kg
Power consumption.....	20W
Operating temperature.....	5 - 35°C
Power Supply.....	AC 220-240V

Disc for recording

For recording use, special audio discs must be used (for music only). These Discs bear the logos as shown below. The text 'DIGITAL AUDIO' is present! Copyright fees have been paid on these discs in some countries.

With your recorder you can use two types of discs for recording purposes:

- **CD-Audio Recordable** (CD-R) discs:
Fully recorded and finalized, these discs play on all CD players and recorders.



- **CD-Audio ReWritable** (CD-RW) discs:
Can be recorded, erased and re-recorded hundreds of times. When finalized, they play on **CD-RW compatible** CD players and recorders.



In the course of 1999 most Philips CD players and recorders will be CD-RW compatible.

Discs for playback

Your CD Recorder/Player can play:

- All prerecorded audio CDs, and combined CDs such as CD Extra.
- All Audio CD-R and Audio CD-RW.

Note: CD-R discs recorded with a computer can only be used when they are correctly treated according the audio standard (IEC958: Consumer part). Single session only!

Maintenance

It is extremely important that the discs used for recording are free of dust and scratches.

To clean a CD, wipe it in a straight line from the center towards the outer edge using a soft, lint-free cloth. Cleaning agents may damage the disc! Write only on the printed side of a CD-R or CD-RW, and only with a soft felt-tipped pen.

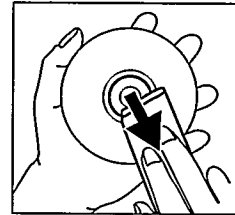

Clean the CD Recorder/Player using a soft, lint-free cloth that has been slightly dampened. Do not use a cleaning agent; this might have a corrosive effect.



Do not expose the CD Recorder/Player the batteries or CDs to extreme humidity, rain, sand or excessive heat from heating equipment or direct sunlight.

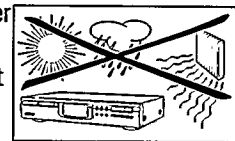

If the CD Recorder/Player does not read the CDs correctly, use a cleaning CD (commonly available) to clean the lens before taking the CD Recorder/Player in for repairs. Other cleaning methods may damage the lens. Keep the tray closed at all times to avoid getting dust on the lens.

The lens may become clouded when the CD Recorder/Player is moved from cold to warm surroundings; it will not be possible to play a CD when this happens. Leave the CD Recorder/Player in the warm surroundings to allow the moisture to evaporate.

Accessories

- 2 Analogue audio cables (with red and white plugs)
- 1 Digital coaxial cable (with black plugs)
- Power cord
- 2 Batteries
- Remote control
- Guarantee

OPERATING BUTTONS AND CONNECTIONS

English

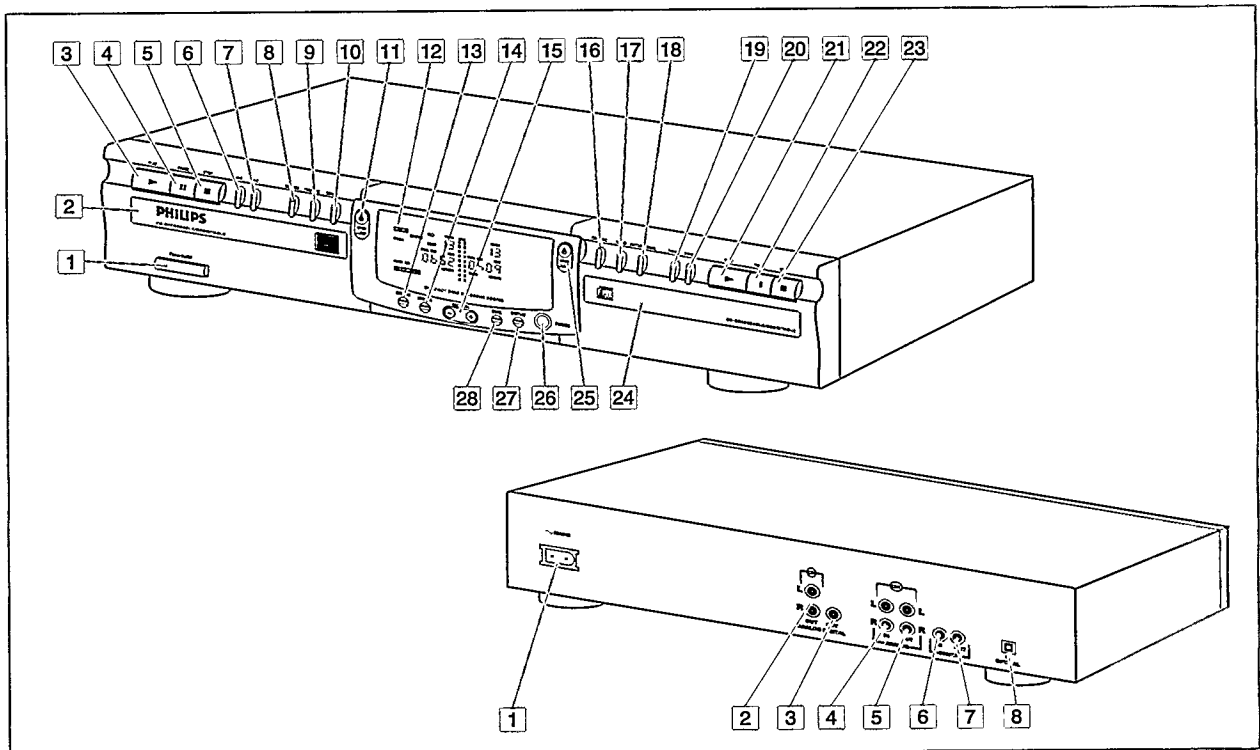

Operating buttons on the front

CD recorder

- 1 **ON/OFF** turn the CD recorder/player ON and OFF
- 2 Disc tray
- 3 **PLAY** ▶ start play or record
- 4 **PAUSE** ■ interrupt play
- 5 **STOP** ■ stops
- 6 ◀◀ previous track/search back
- 7 ▶▶ next track/search forward/new track
- 8 **RECORD** record
- 9 **FINALIZE** finalize recording
- 10 **ERASE** erase recording
- 11 **OPEN/CLOSE** open/close disc tray
- 12 **DISPLAY** (information screen)
- 13 **DISPLAY** select display information
- 14 **SOURCE** select digital or analogue input
- 15 **REC LEVEL** adjusts the recording level (analogue)
- 16 **CD-SYNC** synchronized recording; recording starts automatically
- 17 **DUBB** digital dubbing (normal or high speed) from CD Player to CD Recorder
- 18 **AUTO/MANUAL** .. select track numbering method

CD player

- 19 ◀◀ previous track/search back
- 20 ▶▶ next track/search forward
- 21 **PLAY** ▶ start play

- 22 **PAUSE** ■ interrupt play
- 23 **STOP** ■ stops
- 24 Disc tray
- 25 **OPEN/CLOSE** open/close disc tray
- 26 **PHONES** plug for headphones
- 27 **DISPLAY** select display information
- 28 **DUAL** plays CD Recorder and CD Player separately

Connections on the back

- 1 Connection to power supply
- 4 **ANALOG IN** connects to the line output of an amplifier. (left and right)
- 5 **ANALOG OUT CDR & CD** connection for input line on amplifier (left and right)
- 6 **DIGITAL IN** connection for digital coaxial input from external source, e.g. amplifier or recording device
- 7 **DIGITAL OUT CDR & CD** connects to the digital coaxial input of e.g. amplifier or recording device
- 8 **OPTICAL IN** connection for digital optical input from external CD player

For use only in the DUAL mode (simultaneous play-back):

- 3 **DIGITAL OUT CD** .. connection for digital coaxial output from CD deck to external device, e.g. amplifier or recording device
- 2 **ANALOG OUT CD** . connection for analogue output from CD deck to input line on an amplifier (left and right)

DISPLAY explanation

The display has a section for the CD Recorder and a section for the CD Player.

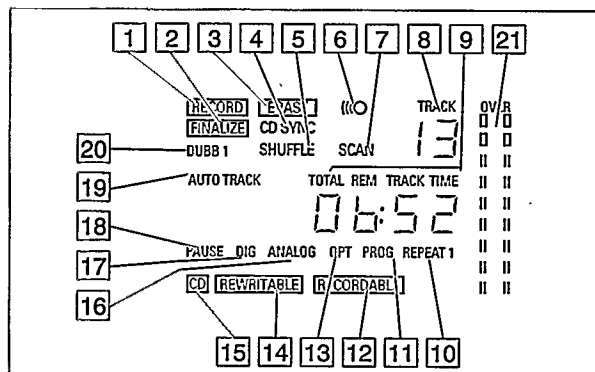

CD recorder section

- 1 **RECORD** lights up during recording and flashes in record standby
- 2 **FINALIZE** lights up during finalizing and flashes in finalize standby
- 3 **ERASE** lights up during erase recording and flashes in erase standby
- 4 **CD-SYNC** synchronized recording is active.
- 5 **SHUFFLE** plays tracks in random order
- 6 **[[O** remote control active
- 7 **SCAN** scans for COPY PROHIBIT or data track in dubbing mode.
- 8 **TRACK** track number
- 9 **TOTAL REM TRACK TIME** lights up according to selected time mode
- 10 **REPEAT (1)** repeat function activated during play
- 11 **PROG** programmed play
- 12 **RECORDABLE** ... Unfinalized CD-R disc inserted
- 13 **OPT** digital optical input is selected
- 14 **REWRITABLE** ... CD-RW disc inserted
- 15 **CD** CD inserted (a pre-recorded CD or finalized CD-R or CD-RW disc)
- 16 **ANALOG** analogue input is selected
- 17 **DIG** lights when digital input is selected and flashes when digital input is incorrect.
- 18 **PAUSE** pause function is active
- 19 **AUTO TRACK** ... automatically increase track numbers
- 20 **DUBB (1)** dubbing from CD player to CD recorder
- 21 Record/play level bar (analogue)

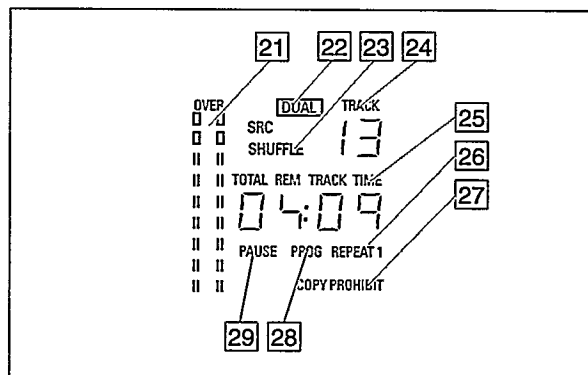

CD player section

- 22 **DUAL** play CD Recorder and CD Player separately
- 23 **SHUFFLE** plays tracks in random order
- 24 **TRACK** track number
- 25 **TOTAL REM TRACK TIME** lights up according to selected time mode
- 26 **REPEAT 1** repeat track
- 27 **COPY PROHIBIT** .. lights up when attempting to record a protected digital audio recording
- 28 **PROG** programmed play
- 29 **PAUSE** pause function is active

DISPLAY

DISPLAY messages

Messages, as listed and explained here may appear on the display for your guidance.

READ INplayer is reading disc information
OPCduring OPC procedure
OPENduring tray opening
CLOSEduring tray closing
NO DISCno disc inserted, or disc unreadable
UPDATEupdating disc contents
RECOVERduring recovery procedure
BUSYrecording pause (four seconds) in progress
or tracks are being scanned in DUBB mode
SYNCduring synchronized recording standby
ERAduring erase-track standby
DISCduring erase-disc standby
NO OPClaser power calibration failed.
Recording no longer possible
FULLprogram full
CDFULLno more recording possible
NO AUDIO(flashing) no audio disc loaded or failure to
read data
FINALlaser power calibration performed 96
times, finalize disc
DIGITALdigital coaxial input selected
DIGITAL OPTdigital optical input selected
SHUFFLEduring shuffle
RECOVER DISCrecovered disc. Finalizing not possible
FINALflashes during unfinalize disc standby,
lights during unfinalize disc
INPUTduring input selection (CD-SYNC)
ANALOGanalog input selected
DUBB 1normal-speed dubbing
DUBBhigh-speed dubbing
DUALCD Recorder and CD Player operating
separately
SELECT CDCD Player selection
SELECT CDRCD Recorder selection
DUAL OFFseparate operation off
PROG CDstart CD Player programming
PROG CDRstart CD Recorder programming
(playback)
DIGITAL RECtrack will be recorded digitally
03dbrecording sensitivity level -3 dB
0dbrecording sensitivity level 0 dB
3dbrecording sensitivity level 3 dB
6dbrecording sensitivity level 6 dB
NO RECdata (non-audio) track found during scan
ANALOG RECcopy prohibited track found during
dubbing (track will be copied analogue)

Connections general

For playing back on the CD Recorder and/or the CD Player deck, the following output connections are available:

- Digital coaxial output (CD & CD-R)
- Analogue output (CD & CD-R)

We recommend that these be connected to the TAPE or CD-R input on your amplifier.

For external recording, the following input connections are available:

- Digital optical input
- Digital coaxial input
- Analogue input

For playing back on the CD Recorder and CD Player decks separately (DUAL mode), the following output connections are available:

- Digital coaxial output (CD)
- Analogue output (CD)

We recommend that these be connected to the CD input on your amplifier.

The connections to be made depend upon the possibilities your audio equipment offers. Please refer to the user manuals for your other audio equipment first.

Digital recordings, either optical or coaxial, will give the best performance in terms of audio and versatility (e.g. auto-track). (The digital optical connection is less sensitive to external disturbances).

If your equipment does not allow for digital connections, the high quality Analogue/Digital Converter on the CD Recorder/Player will ensure excellent audio performance when recordings are made from an analogue source.

Playback via the digital coaxial output of the CD Recorder/Player gives the best audio performance.

If your equipment does not offer digital connections the high quality Digital-Analog-Converter of the CD Recorder/Player ensures a high sound quality via the analogue output.

We recommend that both digital and analogue connections be made, so that analogue recordings can be made when digital recording is not possible.

The most common ways of connecting the CD Recorder/Player are explained below. If you still have difficulties with the connections, feel free to contact the Philips Consumer Service desk in your country.

Analogue connections CD Recorder & CD Player

This connection must be established for the play-back CD Recorder deck and for the CD Player deck (cable ②)

Cable ① is used only if you want to make recordings from an external analogue source.

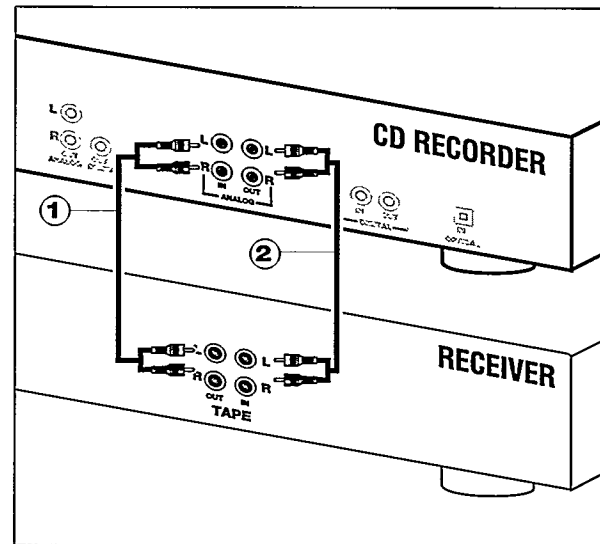

Use the audio cables supplied. Connect the red plugs to the R sockets, and the white plugs to the L sockets.

- 1 For recording from an external source, connect Cable ① to the ANALOGUE IN plug on the CD Recorder/Player and the LINE-OUT or TAPE-OUT plug on an amplifier.

Note: For recording directly from a CD player the analogue input of the CD Recorder/Player should be connected to the analogue output of the CD player.

- 2 For playing back, connect Cable ② to the ANALOGUE OUT plugs on the CD Recorder/Player and the INPUT plugs on an amplifier, e.g. TAPE IN, CD-R or AUX.

Note: Never use the PHONO input.

INSTALLATION

English

Analogue connection CD Player deck

This connection is only required if you want to play back on the CD Player deck separately from the CD Recorder deck. This is called the DUAL mode.

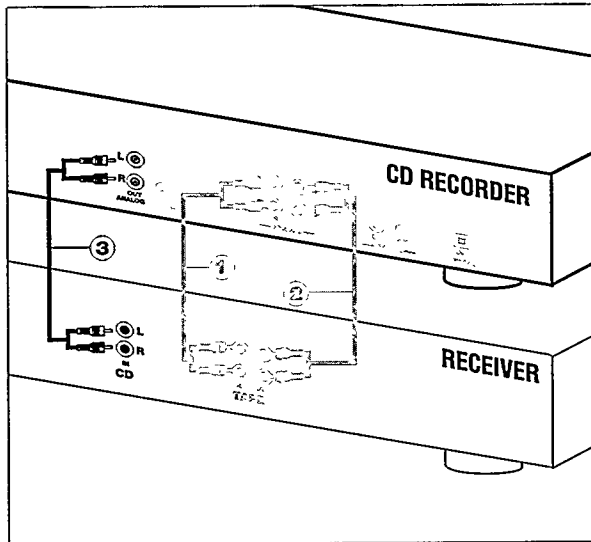

- 1 For playing back separately on the CD Player deck, connect a third cable ③ (not supplied) between the ANALOGUE OUT plugs on the CD Recorder and the INPUT plugs on an amplifier, e.g. CD or AUX.

(Connect the red line in the R plugs and the white line in the L plugs.)

Note:

- Never use the PHONO input
- Your CD Recorder/Player is equipped with a digital coaxial output for the CD Player deck. This output connection can be used for digital play-back.

Digital Coaxial Connection CD Recorder

This connection is only required if you want to record from an external CD player with a digital coaxial output.

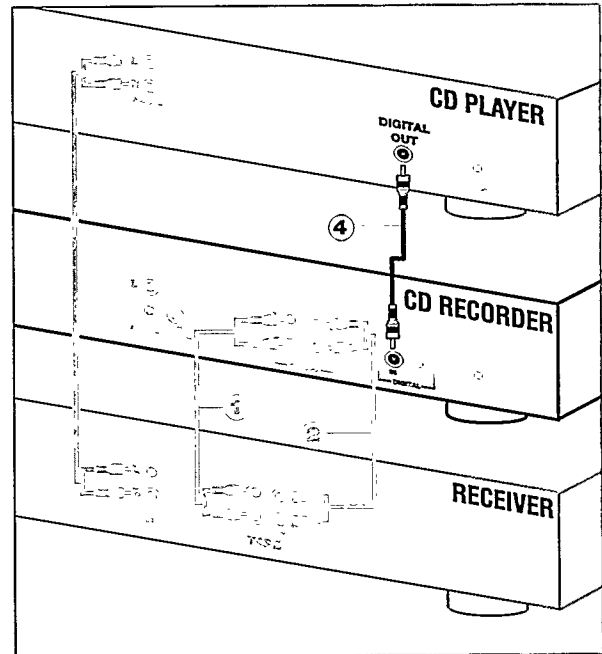

- 1 For recording from an external source, use a fourth cable ④ (not supplied) to connect the DIGITAL IN plug on the CD Recorder/Player to the DIGITAL OUT plug on an external CD player.

Note: Your CD Recorder/Player is equipped with a digital coaxial output plug (common plug for CD Recorder deck and CD Player deck). This output can be used for digital play-back.

Digital Optical Connection CD Recorder

This connection is only required if you want to record from an external CD player with a digital optical output.

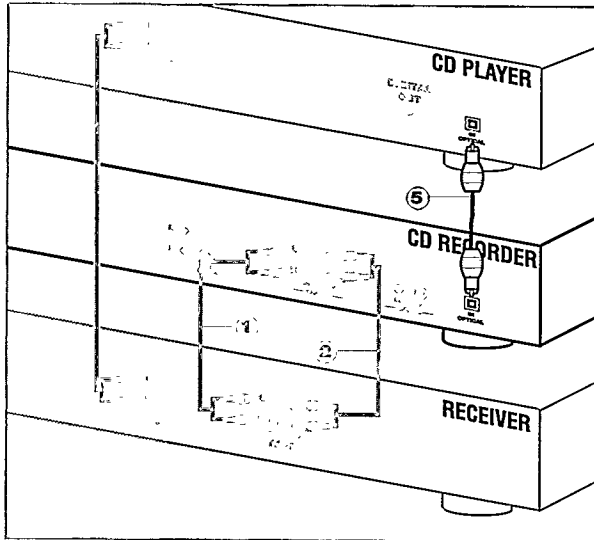

- 1 Remove the dust caps from the digital optical connections. (We recommend that you save the caps).
- 2 For recording from an external source, use a fiber-optic cable (5) to connect the digital optical input on the CD Recorder/Player and the digital optical output on an external CD player.

Note: For playing back, the digital coaxial outputs or analogue outputs on the CD Player and the CD Recorder must be connected to an amplifier.

Power supply

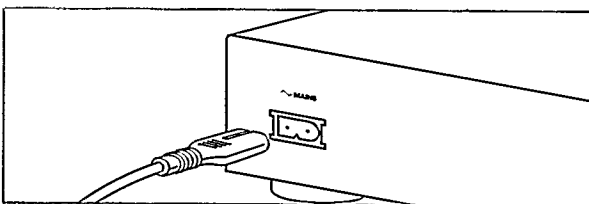

- 1 Plug the power cord supplied into the MAINS connector on the CD Recorder/Player, then into a wall socket.
- 2 Press ON/OFF to turn the CD Recorder/Player on.

Note:

- The CD Recorder/Player will automatically adjust to the local mains voltage.
- When the CD Recorder/Player is in the 'OFF' position, it is still consuming some power. If you wish to disconnect your CD Recorder/Player completely from the mains, withdraw the plug from the AC Outlet.

Setup recommendations

- Place the CD Recorder/Player on a solid, vibration free surface.
- Do not place the CD Recorder/Player near a source of heat or in direct sunlight.
- Do not use the CD Recorder/Player under extremely damp conditions.
- If the CD Recorder/Player is placed in a cabinet, make sure that a one-inch space remains free on all sides of the recorder for proper ventilation.

Inserting batteries in the remote control

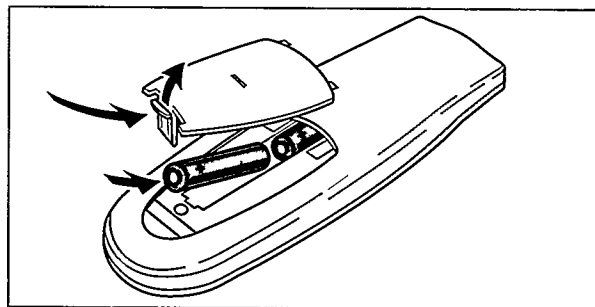

- 1 Open the battery compartment cover.
- 2 Insert 2 batteries (AAA, R03 or UM-4; as supplied) as shown.
- 3 Replace the cover.

Note: We recommend using 2 batteries of the same type and condition.

Batteries contain chemical substances; dispose of them properly.

REMOTE CONTROL & INSERTING DISCS

Remote control commands

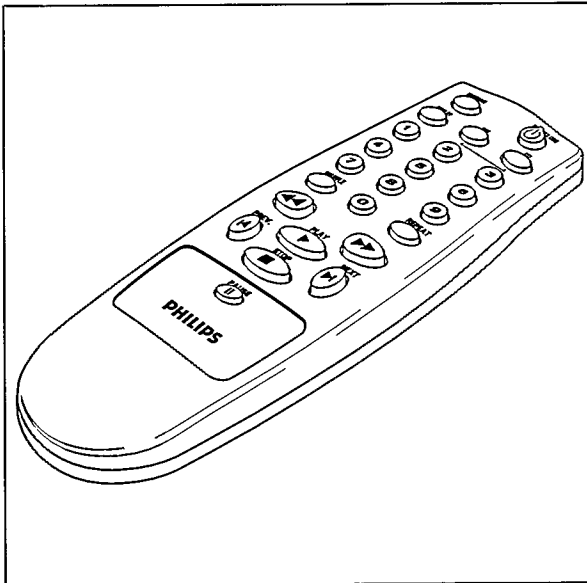

- PROGRAM** programs track numbers
- DISPLAY** selects display information
- Number keys 0 - 9** ... Sets a track by number
- SHUFFLE** plays CD(RW) or program in random order
- ◀◀** Searches backward
- PREVIOUS** ◀ selects the beginning of a previous track
- STOP** ■ stops CD(RW) and clears a program
- PAUSE** ■■ interrupts CD(RW) play
- NEXT** ▶ selects the beginning of subsequent
- PLAY** ▶ starts CD(RW) play
- ▶▶** Searches forward
- REPEAT** repeat play
- CD** select CD Player
- CD-R** select CD Recorder
- OPEN/CLOSE** Opens or closes the disc tray

When you press a button on the remote control, the indicator on the display will light up.

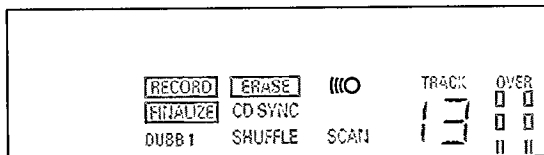

Note: Unless indicated otherwise, all buttons are located on the front of the CD Recorder/Player. If also provided on the remote control, the corresponding buttons on the remote control can be used after the CD Recorder or the CD Player has been selected by pressing CD-R or CD.

Inserting discs

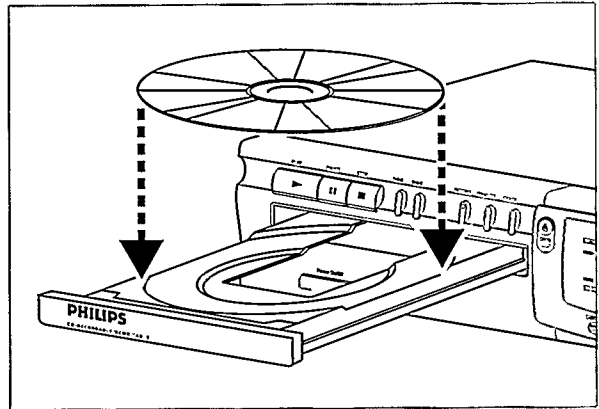

- 1 Press OPEN/CLOSE (**11**) to open the disc tray.
- 2 Insert a CD, CD-R or, CD-RW in the appropriate recess in the tray, label side up.

IMPORTANT:

For recording it is important that the blank disc be completely free of dust particles or scratches. (see Disc Maintenance, p.5).

Unfinalized discs cannot be played in the CD Player deck!

- 3 Gently push the front of the tray or press OPEN/CLOSE to close the tray (see also Playing a CD).

CD-Recorder only

→The display will indicate the type of disc you have inserted.

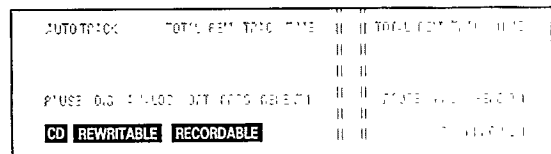

- If a CD-R is finalized the display will indicate **CD**.
- If a CD-RW is finalized it is still a CD-ReWritable and the display will indicate **CD REWRITABLE**.

If you insert a blank or partly-recorded CD-R or CD-RW, the CD recorder will calibrate the disc for optimum recording. During this process the display will first show **OPC** and then the number of audio tracks previously recorded. Calibration can take up to 25 seconds.

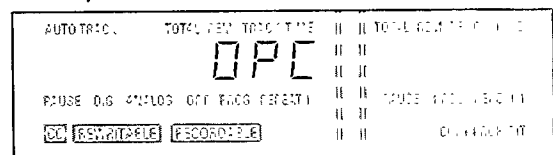

Note: Only Audio CDs will be accepted. If a non-audio disc is inserted, the display will indicate **NO AUDIO**.

Remarks about recording

You will soon discover how easy it is to make your own CDs. Nevertheless, we recommend that you use a CD-RW disc for your first try. The two ways to make recordings are described below:

- Digital dubbing (normal or high-speed dubbing)
- Recording from an external source:
 - Digital
 - Digital with synchronized start using external CD player
 - Analogue
- The recording procedure is the same for CD-Rs or CD-RWs.
- If the disc is a CD-RW and is already finalized you must unfinalize it first (page 17).
- If the disc already contains recordings, the CD recorder will automatically search for the end of the last track, so that you can start recording from there.
- There must be at least 7 seconds of recording time left on the disc, or you will not be able to activate the record standby mode.
- If the display indicates **COPY PROHIBIT**, no digital recording can be made of the source material. Recording will not start or will stop after 4 seconds.
- The **Serial Copy Management System (SCMS)** only allows digital recording under specific conditions:
 - It is not possible to make a digital copy from a digital copy.
 - Analogue recording is always possible!
 - The number of recordings from the original is unlimited.
- A maximum of 99 tracks can be recorded on a disc. The minimum allowable track length is 4 seconds.
- Digital recordings can be made from CDs (or other sources with an output Sample Frequency of 44.1 kHz +/- 100 ppm) via the digital input.
- Recordings from DAT or DCC players will not stop automatically.

Important:

If you want to play back the recorded CD-R disc on the CD Player deck or on any other regular CD player, it must be finalized first. See the instructions for finalizing discs (page 17).

Finalized CD-RW discs play only on CD-RW compatible CD players.

Normal and high-speed dubbing

Use the dubbing feature for high-speed recording from the CD Player deck to the CD Recorder deck. The quality of the original recording will be retained.

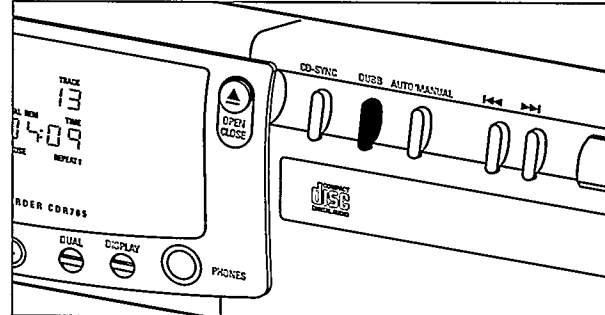

Some comments about dubbing:

- A complete disc or program can be copied at high speed (**DUBB**).
- Single tracks or programs can be copied at normal speed (**DUBB-1**).
- Track numbers will be increased automatically.
- Track numbers cannot be increased manually.

Preparing for normal and high-speed dubbing

- 1 Make sure that the recording disc is completely free of scratches and dust particles.
- 2 If necessary, press the **DUAL** button to switch off the **DUAL** mode on the display.
 - **DUAL** should be off.

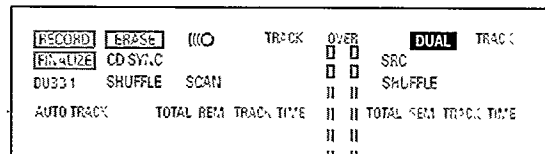

Start high-speed dubbing (Disc copy)

- 1 To record a complete disc or program, press **DUBB** repeatedly until:
 - **dubb** appears and **DUBB** flashes on the display. After some time, **BUSY** and the track number will appear on the display. The CD Player will scan the tracks on the CD and then stop.

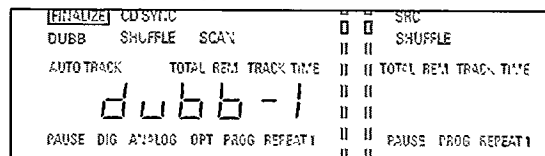

- To see the tracks that will be recorded, press **DISPLAY**.
 - The track numbers will be shown in sequence.
 - If **NO DFE** appears, the track cannot be dubbed.
 - If **ANALOGUE REC** appears, the tracked will be dubbed analogue at normal speed.
 - All other tracks will be copied in the normal fashion at double speed.
 - Tracks for which **IS SERIAL REC** appears will be digitally recorded at double speed.

Start digital recording

- 1 With the recorder stopped, press RECORD to enter the Record standby mode.
→ RECORD flashes.

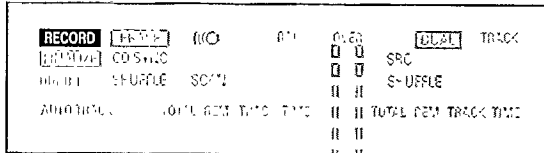

- If DIG also flashes, the digital connection is incorrect.
- 2 To start recording, press PLAY on the CD Recorder/Player and immediately start the source (from the stop mode).
→ RECORD lights continuously. The track number and recording time used will be indicated on the display.
 - To record a three-second pause (silence) at the beginning of a track, press PAUSE on the CD Recorder/Player.
 - To check the (remaining) recording time, press DISPLAY. (This can also be done during the recording.)
 - 3 To stop recording, press STOP on the CD Recorder/Player.
→ RECORD will go out.
 - To interrupt recording, press PAUSE.
→ RECORD starts to flash. Resume at step 2.

After recording the display will show **UPD FILE** for several seconds.

*Note: With **AUTO TRACK** on, the recorder will stop automatically. Recordings from **DAT** or **DCC** will stop after 20 seconds silence. With **AUTO TRACK** off, the **AUTO STOP** mode is disabled.*

Synchronized digital recording from an external CD player - CD-SYNC

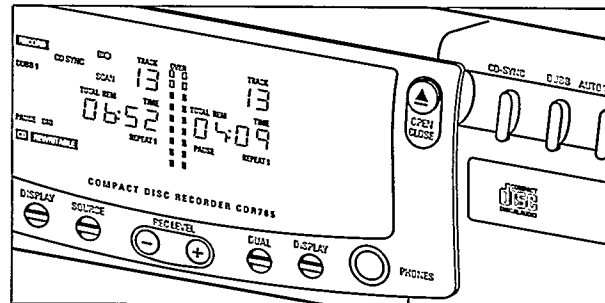

Preparing for synchronized digital recording

The CD-SYNC feature enables you to make fast and easy digital recording of a CD. Track increments are automatically detected from the digital source material. Track increments cannot be added manually.

- 1 Make sure the disc is absolutely free of scratches and dust particles.
- 2 Press SOURCE repeatedly until (depending on the connection used):
→ **DIG d IS IERL** or **DIG OPT IERL** will appear on the display.

- If necessary, press DUAL to switch off the DUAL mode; DUAL will no longer appear on the display.

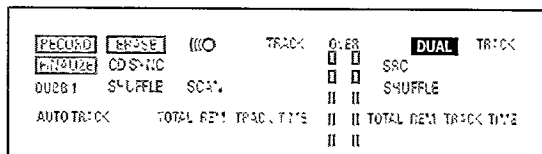

Start synchronized digital recording

- 1 With the CD Recorder/Player stopped, press CD-SYNC.
→ On the display, **CD-SYNC** & **SYNC** appear. After a time, **RECORD** starts to flash.

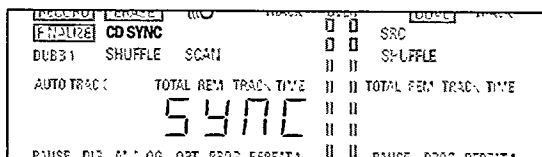

- If DIG also flashes, the digital connection is incorrect.
- 2 To start recording, press PLAY on the external digital source.
→ The CD Recorder/Player automatically starts to record and **RECORD** lights continuously. The track number and recording time used will be indicated on the display
 - If you start the source during a track, CD-SYNC will not start recording until the beginning of the next track.

RECORDING

- To check the (remaining) recording time, press DISPLAY. (This can also be done during recording)
- 3 To stop recording, press STOP on the CD Recorder/Player. → CD-SYNC and RECORD go out.
- To interrupt recording, press PAUSE. → RECORD starts to flash. To resume, press PLAY on the CD Recorder/Player.

After recording the display will show **UPDARE** for several seconds.

Note:

- The CD Recorder/Player will not start until it recognizes a digital signal. Although the reaction time is less than 200 milliseconds, the very beginning of the music may sometimes not be recorded. If this happens, you can start the recording manually (see digital recording - unsynchronized).
- Recordings from DAT or DCC will only stop after 20 seconds silence.

Analogue recording from an external source

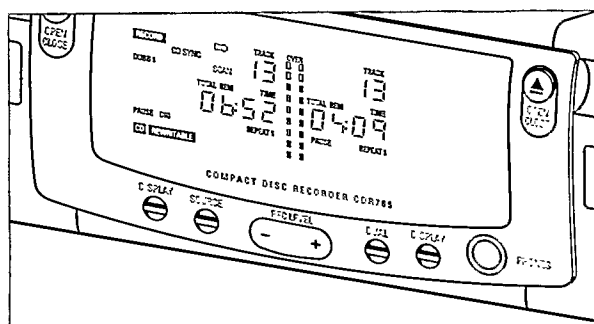

Only make analog recordings if digital recording is not possible.

Preparing for analogue recording

- 1 Make sure the disc is absolutely free of scratches and dust particles.
- 2 Press SOURCE repeatedly until: → **ANALOG** appears on the display.

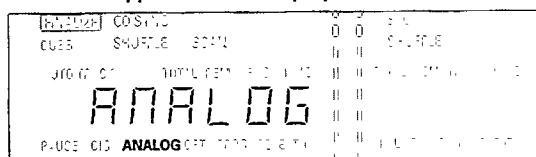

- If necessary, press DUAL to switch off the **DUAL** mode; **DUAL** will no longer appear on the display.

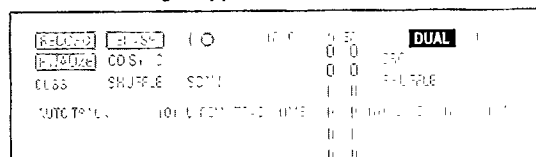

- 3 Press AUTO/MANUAL to switch between auto and manual track numbering.

→ If Auto is selected (preferred), **AUTO TRACK** appears on the display.

- **AUTO:** The track number is automatically incremented after a silence on the original of at least 3 seconds.
- **MANUAL:** Track numbers can be incremented manually by pressing **▶▶**. (minimum track length is 4 seconds). (This can also be done in AUTO mode)

- Track numbers cannot be changed after recording.

- 4 With the recorder stopped, press RECORD to enter Record standby mode.

→ **RECORD** will flash

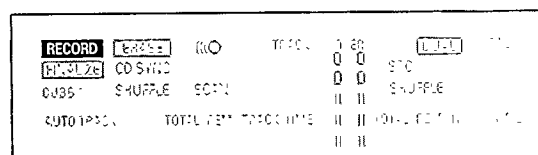

- 5 Play the source first to set the optimal recording level on the CD Recorder/Player.
- 6 Press REC LEVEL (+ or -) repeatedly until all the blue segments on the Record/Play level bar light up continuously but the red segments do not during the loudest passages.
→ The display will show 03db or 0db or 3db or bdb
- 7 Stop the source.

Start analogue recording

- 1 To start recording, press PLAY on the CD Recorder/Player and immediately start the source.
→ RECORD lights continuously. The track number and recording time used appear on the display.
- To record a 3-second silence at the start of a track, press PAUSE.
- To check the (remaining) recording time, press DISPLAY. (This can also be done during the recording)
- 2 To stop recording, press STOP on the CD Recorder/Player.
→ RECORD will go out.
- To interrupt recording, press PAUSE.
→ RECORD will start to flash. Resume at step 1.

After recording the display will show **UPDARE** for several seconds.

*Note: With **AUTO TRACK** on, the recorder will stop automatically after a 20 seconds silence. With **AUTO TRACK** off, the **AUTO STOP** mode is disabled.*

Finalizing CD-R & CD-RW discs

Finalizing is a simple procedure that is necessary in order to play back the discs on the CD Recorder/Player or on an external CD player.

Note: Finalizing prevents any further recording on a CD-R. A finalized CD-RW must be unfinalized to allow further recording or erasure of tracks.

- 1 Make sure the disc (in the CD Recorder/Player) is absolutely free of scratches and dust particles.
- 2 With the recorder stopped press FINALIZE and then within 3 seconds press RECORD.

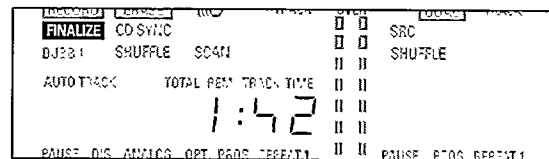

- The approximate finalization time will appear in the display.
RECORD & FINALIZE lights up. The display counts down through the finalization.
On completion, the total number of tracks and the total time recorded will appear on the display.
For CD-R **CD RECORDABLE** will change to **CD** on the display.
For CD-RW no change will be seen on the display.

Finalizing will last at least 2 minutes.

Note: During finalisation, the CD Recorder/Player accepts no operating commands.

Unfinalizing CD-RW discs

For CD-RW discs only.

If you want to make more recordings (or to erase tracks) on a finalized disc you must unfinalize it first. The Table of Contents (TOC) on the disc will be removed.

To unfinalize:

- 1 Press ERASE twice.
→ On the display, **EOC** and **ERASE** will flash.

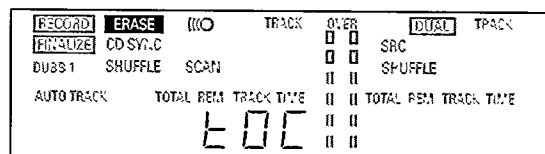

- 2 Press RECORD within 3 seconds.
→ **EOC** and **ERASE** light up continuously during erasure.

Note: This will take approximately 1 minute.

ERASING & PLAYING

Erasing CD-RW discs

For CD-RW discs only.

You can erase:

- track by track from the end.
- the entire disc.

To erase the last track :

1 Make sure the disc is not finalized (Showing **DPC** on display during start up). Otherwise unfinalize first (p.17)

2 Press ERASE.

→ On the display, **ERA** and **ERASE** will flash.

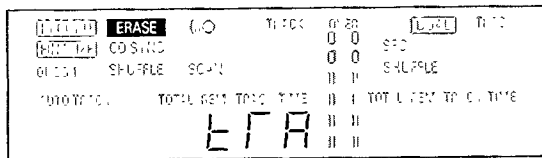

3 Press RECORD within 3 seconds.

→ **ERA** and **ERASE** light continuously during erasure.

To erase the entire disc:

1 Press ERASE once (for finalized CD-RW) and twice (for unfinalized CD-RW)

→ On the display, **d15C** and **ERASE** will flash.

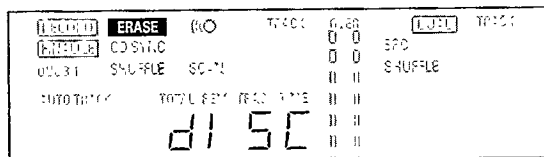

2 Press RECORD within 3 seconds.

→ **d15C** and **ERASE** light continuously during erasure.

Erasure of a complete disc may take up to 1.5 minutes.

Playing CDs on Deck 1 and/or Deck 2

With your CD Double Deck, you can play the CD Recorder deck and/or the CD Player deck either simultaneously or separately (DUAL). For separate playing, the extra CD output must also be connected to an amplifier (see page 9).

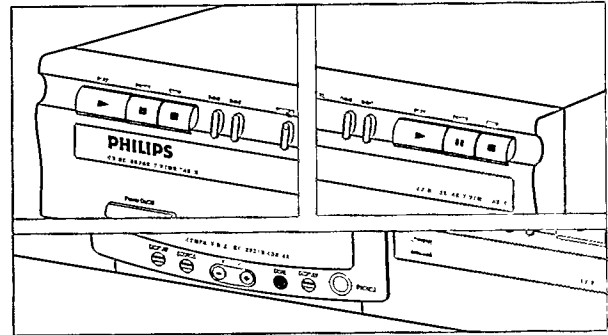

1 Press DUAL to switch **DUAL** on.

→ **DUAL** will light up continuously

2 On the deck you want to use, press PLAY to start CD play.

→ The track number and the track time for the deck in play will appear on the display, together with the record/play level indicator.

3 Press DISPLAY once, twice or three times to see:

→ Remaining track time, total remaining time, or total track time (without level indicator).

4 To interrupt play temporarily, press PAUSE.

→ **PAUSE** will light up on the display

5 To continue play, press PAUSE again or press PLAY.

6 To stop play, press STOP.

→ The number of tracks and the total playing time will appear on the display.

Playing as a 2-disc changer

Your CD Recorder/Player can play CDs in both decks either successively or in random order (SHUFFLE play).

1 Press DUAL to switch **DUAL** off

→ **DUAL** should be off.

2 On the deck you want to use, press PLAY to start CD play.

→ The track number and track time of the deck in play appear on the display, together with the record/play level indicator.

After the first disc has played, the second disc will be played.

TIP:

Use SHUFFLE to play the tracks on the two discs in random order (see SHUFFLE, page 19).

- 3 Press DISPLAY once, twice or three times to see:
 - Remaining track time, total remaining time, or total track time with level indicator off.
- 4 To temporarily interrupt play, press PAUSE.
 - PAUSE will light up on the display.
- 5 To continue play, press PAUSE again or press PLAY.
- 6 To stop play, press STOP.
 - The number of tracks and the total playing time on the CD will appear on the display.

Selecting a track or searching

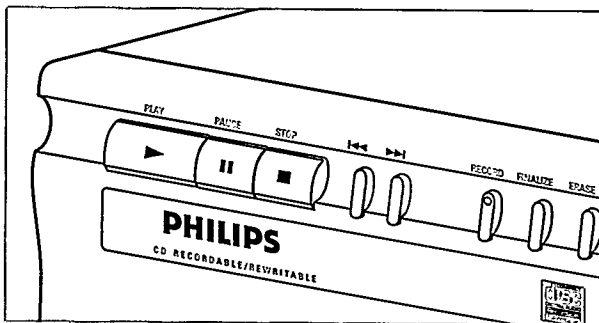

Selecting a track during play

- 1 Briefly press [◀◀ or ▶▶] one or more times.
 - The player will skip to the beginning of the current, previous or next tracks, including tracks on the other disc when both decks are in use as a 2-disc changer.
- or
- Select CD-R or CD on the remote control, then press the desired track number using the numeric key pad on the remote control. For two-digit track numbers, press the numeric keys in rapid succession. For tracks on the other disc, select the desired deck first by pressing CD or CD-R.
 - Play will skip to the beginning of the selected track.

Selecting a track when CD is not playing

- 1 Briefly press [◀◀ or ▶▶] one or more times.
 - or
 - Select CD-R or CD on the remote control, then press the desired track number using the numeric key pad on the remote control. For two-digit track numbers, press the numeric keys in rapid succession.
- 2 Press PLAY.
 - Play will start with the track selected.

Searching during CD play

- 1 Hold down [◀◀ or ▶▶] on the front of the deck or ◀◀ or ▶▶ on the remote control.
 - The player will search either forward or backward at ten times the normal speed with the sound on low level, and will then search at fifty times the normal speed with the sound muted. The search will extend over both discs if the changer mode (DUAL off) is activated.

- 2 Release the button when the desired passage has been found.
 - Play will start with the desired passage.

Note: During Shuffle, Repeat or Programmed play, search is restricted to within the track being played at the time.

Shuffle (random order) play

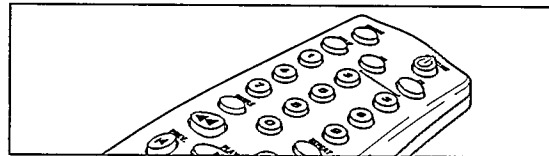

- 1 Press DUAL to switch off the DUAL mode and to switch on the two-disc changer mode.
 - DUAL should not be lighted on the display.
- 2 Press SHUFFLE on the remote control before starting or during play to activate shuffle play.
 - The tracks on the CD (or in program if programmed) will play in random order. SHUFFLE will appear on the display between tracks.
- 3 Press SHUFFLE again to return to normal CD play.

Note: Shuffle is also cleared when you open the disc tray.

Repeat CD, track or program

- 1 Press REPEAT on the remote control one or more times during CD play.
 - When REPEAT 1 appears on the display, the current track plays repeatedly. When REPEAT appears on the display, the discs or programmes play repeatedly.
- 2 To return to normal play, press REPEAT one or more times until:
 - The repeat message disappears from the display.

Note:

- You can use shuffle in combination with repeat CD or programmed play using the two-disc changer.
- Repeat will also be cleared if you open the disc tray.

PLAYING

Programming

You can program up to thirty tracks to play in a desired sequence using either the CD Player deck or the CD Recorder/Player. Individual tracks can be included in the program more than once, but will count as a track each time they are included.

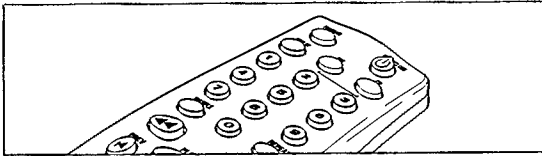

- 1 Press CD-R or CD on the remote control to select a deck.
→ The message *SELECT CdR* or *SELECT Cd* will briefly appear on the display.
- 2 Press PROGRAM on the remote control to start programming.
→ **PROG** will flash and *PROG CdR* or *PROG Cd* will briefly appear on the display.
- 3 Press a track number with the number keys. For 2-digit numbers, press the keys in rapid succession.
→ On the display, the track number appears briefly, followed by the total programmed tracks and total program time.
- 4 Repeat step 2 for all tracks to be programmed.
- 5 Press STOP or PROGRAM to end programming.
→ **PROG** lights continuously.

Note:

- To review the program, press [**◀** or **▶**] with the deck in the stop mode.
- To add more tracks to the program, repeat steps 1 through 6.
- If you try to store more than 30 tracks, *FULL* appears on the display

- 6 Press PLAY to start programmed play.

Clearing a program

- 1 Press STOP if necessary to stop programmed play.
- 2 Press STOP again to clear the program.
→ **PROG** disappears from the display.

Note: The program is also cleared when you open the disc tray.

Troubleshooting

If you think your CD Recorder/Player is defective, it is wise to check this list first, and run the diagnostic program. Maybe you have forgotten a simple step.

Warning!

Under no circumstances should you attempt to repair the CD Recorder/Player yourself as this will invalidate the guarantee.

SYMPTOM: • SOLUTION:

- No power**
- check to ensure that the ON/OFF button is on
 - check to ensure that the power cable is plugged in correctly
 - switch the recorder OFF and then immediately back ON

Auto track does not work

- check to ensure that auto track is selected.
- check to ensure that there are 3 seconds silence in between the tracks (analogue recording only)
- check to ensure that the source is a consumer source with the digital output according the IEC audio standard.

- No sound**
- check the audio connections
 - if using an amplifier, try using a different source

Amplifier sound is distorted

- check to ensure that the CD Recorder/Player analogue output is not connected to the amplifier Phono input.

Play will not start

- check to ensure that the label of the CD is facing up
- clean the disc
- check to ensure that the disc is not defective by trying another disc
- make sure that the disc has been finalized for play in a CD player.

Remote control does not work

- point the remote control directly at the CD Recorder/Player
- check the batteries and replace if necessary

Will not record

- clean the disc
- check to ensure that CD-RW is not finalized
- check to ensure that the disc is recordable and replace if necessary
- make sure the disc is an AUDIO disc (NO RW ID may not appear)
- wrong input source selected.

Analog recording is distorted

- make sure the recording level is correct

20 second pause between recordings

- see Synchronized digital recording (CD-SYNC) p.15

Player does not react

- switch the ON/OFF button on the front of the player off and back on

RECOVER on display

- a power failure has occurred during recording, the CD Recorder/Player is attempting to repair the disc.
- if *RECOVER* then appears on the display, the disc cannot be recorded further, and cannot be finalized. It can, however, still be played on the CD Recorder/Player or on another CD recorder.
- on a CD-RW disc, the track being recorded is lost, but further recording and finalization can still be done.
- If *NO OFC* appears on the display, the disc cannot be used for recording. However, it can still be used as a CD on this recorder.

NO OFC on display

- While scanning a CD before recording, a non-audio track was detected. This track cannot be copied and will be skipped.

Diagnostic program

If the malfunction persists, perform the Diagnostic Program:

1 Switch the CD Recorder/Player off using ON/OFF.

2 Simultaneously press PLAY and STOP and switch the CD Recorder/Player back on using ON/OFF.

→ The display will now indicate *BUSY* and after a few minutes, the message will change to *0000* or *PASSEd*

- If the *0000* message appears, your recorder is defective and needs to be repaired. Consult your supplier or call the Philips Consumer Line to find the nearest service centre. The number of the Consumer Line can be found in the guarantee booklet.
- If the *PASSEd* message appears, you may be misinterpreting the user instructions or using an inappropriate disc, or there may be a mechanical defect or an incorrect connection. Carefully read the user instructions once again; and if necessary contact your supplier.
- If you cannot solve the problem, contact to the nearest service centre.

3 Switch off the CD Recorder/Player using ON/OFF to exit from the Diagnostic Program.



3104 125 2251.1

The products and services described herein are not necessarily available in all countries.
The specifications and design of this product are subject of change without notice.

Printed in Hungary.

© PHILIPS 1998

All trademarks acknowledged.

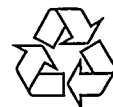

Free Manuals Download Website

<http://myh66.com>

<http://usermanuals.us>

<http://www.somanuals.com>

<http://www.4manuals.cc>

<http://www.manual-lib.com>

<http://www.404manual.com>

<http://www.luxmanual.com>

<http://aubethermostatmanual.com>

Golf course search by state

<http://golfingnear.com>

Email search by domain

<http://emailbydomain.com>

Auto manuals search

<http://auto.somanuals.com>

TV manuals search

<http://tv.somanuals.com>