

Color Television
TP2797B1

Instructions for use



Let's make things better.

PHILIPS **MAGNAVOX**

3135 015 12891

Download from Www.Somanuals.com. All Manuals Search And Download.

Return your Warranty Registration card today to ensure you receive all the benefits you're entitled to.

Once your PHILIPS MAGNAVOX purchase is registered, you're eligible to receive all the privileges of owning a PHILIPS MAGNAVOX product. So complete and return the Warranty Registration Card enclosed with your purchase at once. And take advantage of these important benefits.

Warranty Verification

Registering your product within 10 days confirms your right to maximum protection under the terms and conditions of your PHILIPS MAGNAVOX warranty.

Owner Confirmation

Your completed Warranty Registration Card serves as verification of ownership in the event of product theft or loss.

Model Registration

Returning your Warranty Registration Card right away guarantees you'll receive all the information and special offers which you qualify for as the owner of your model.

Congratulations on your purchase, and welcome to the "family!"

PHILIPS MAGNAVOX



Dear PHILIPS MAGNAVOX product owner:

Thank you for your confidence in PHILIPS MAGNAVOX. You've selected one of the best-built, best-backed products available today. And we'll do everything in our power to keep you happy with your purchase for many years to come.

As a member of the PHILIPS MAGNAVOX "family," you're entitled to protection by one of the most comprehensive warranties and outstanding service networks in the industry.

What's more, your purchase guarantees you'll receive all the information and special offers for which you qualify, plus easy access to accessories from our convenient home shopping network.

And most importantly you can count on our uncompromising commitment to your total satisfaction.

All of this is our way of saying welcome—and thanks for investing in a PHILIPS MAGNAVOX product.

Sincerely,

Robert Minkhorst
President and Chief Executive Officer

P.S. Remember, to get the most from your PHILIPS MAGNAVOX product, you must return your Warranty Registration Card within 10 days. So please mail it to us right now!

Know these safety symbols



This "bolt of lightning" indicates uninsulated material within your unit may cause an electrical shock. For the safety of everyone in your household, please do not remove product covering.

The "exclamation point" calls attention to features for which you should read the enclosed literature closely to prevent operating and maintenance problems.

WARNING: TO PREVENT FIRE OR SHOCK HAZARD, DO NOT EXPOSE THIS EQUIPMENT TO RAIN OR MOISTURE.

CAUTION: To prevent electric shock, match wide blade of plug to wide slot, and fully insert.

ATTENTION: Pour éviter les chocs électriques, introduire la lame la plus large de la fiche dans la borne correspondante de la prise et pousser jusqu'au fond.

PHILIPS MAGNAVOX Visit our World Wide Web Site at <http://www.philipsmagnavox.com>

SAFETY INSTRUCTIONS - Read before operating equipment

This product was designed and manufactured to meet strict quality and safety standards. There are, however, some installation and operation precautions which you should be particularly aware of.

1. **Read Instructions** - All the safety and operating instructions should be read before the appliance is operated.
2. **Retain Instructions** - The safety and operating instructions should be retained for future reference.
3. **Heed Warnings** - All warnings on the appliance and in the operating instructions should be adhered to.
4. **Follow Instructions** - All operating and use instructions should be followed.
5. **Water and Moisture** - The appliance should not be used near water - for example, near a bathtub, washbowl, kitchen sink, laundry tub, in a wet basement or near a swimming pool, etc.
6. **Carts and Stands** - The appliance should be used only with a cart or stand that is recommended by the manufacturer.
- 6A.  An appliance and cart combination should be moved with care. Quick stops, excessive force, and uneven surfaces may cause the appliance and cart combination to overturn.
- 6B. **Tilt/Stability** - All televisions must comply with recommended international global safety standards for tilt and stability properties of its cabinet design.
 - Do not compromise these design standards by applying excessive pull force to the front, or top, of the cabinet which could ultimately overturn the product.
 - Also, do not endanger yourself, or children, by placing electronic equipment/toys on the top of the cabinet. Such items could unsuspectingly fall from the top of the set and cause product damage and/or personal injury.
7. **Wall or Ceiling Mounting** - The appliance should be mounted to a wall or ceiling only as recommended by the manufacturer.
8. **Ventilation** - The appliance should be situated so that its location or position does not interfere with its proper ventilation. For example, the appliance should not be situated on a bed, sofa, rug, or similar surface that may block the ventilation openings; or, placed in a built-in installation, such as a bookcase or cabinet that may impede the flow of air through the ventilation openings.
9. **Heat** - The appliance should be situated away from heat sources such as radiators, heat registers, stoves, or other appliances (including amplifiers) that produce heat.
10. **Power Sources** - The appliance should be connected to a power supply only of the type described in the operating instructions or as marked on the appliance.

11. **Power-Cord Protection** - Power supply cords should be routed so that they are not likely to be walked on or pinched by items placed upon or against them, paying particular attention to cords and plugs, convenience receptacles, and the point where they exit from the appliance.
12. **Cleaning** - The appliance should be cleaned only as recommended by the manufacturer.
13. **Power Lines** - An outdoor antenna should be located away from power lines.
14. **Outdoor Antenna Grounding** - If an outside antenna is connected to the receiver, be sure the antenna system is grounded so as to provide some protection against voltage surges and built up static charges.

Section 810 of the National Electric Code, ANSI/NFPA No. 70-1984, provides information with respect to proper grounding of the mats and supporting structure grounding of the lead-in wire to an antenna discharge unit, size of grounding connectors, location of antenna-discharge unit, connection to grounding electrodes and requirements for the grounding electrode. See Fig. below.
15. **Non-use Periods** - The power cord of the appliance should be unplugged from the outlet when left unused for a long period of time.
16. **Object and Liquid Entry** - Care should be taken so that objects do not fall and liquids are not spilled into the enclosure through openings.
17. **Damage Requiring Service** - The appliance should be serviced by qualified service personnel when:
 - A. The power supply cord or the plug has been damaged; or
 - B. Objects have fallen, or liquid has been spilled into the appliance; or
 - C. The appliance has been exposed to rain; or
 - D. The appliance does not appear to operate normally or exhibits a marked change in performance; or
 - E. The appliance has been dropped, or the enclosure damaged.
18. **Servicing** - The user should not attempt to service the appliance beyond that described in the operating instructions. All other servicing should be referred to qualified service personnel.

Note to the CATV system installer: This reminder is provided to call the CATV system installer's attention to Article 820-40 of the NEC that provides guidelines for proper grounding and, in particular, specifies that the cable ground shall be connected to the grounding system of the building, as close to the point of cable entry as practical.

Example of Antenna Grounding as per NEC - National Electric Code

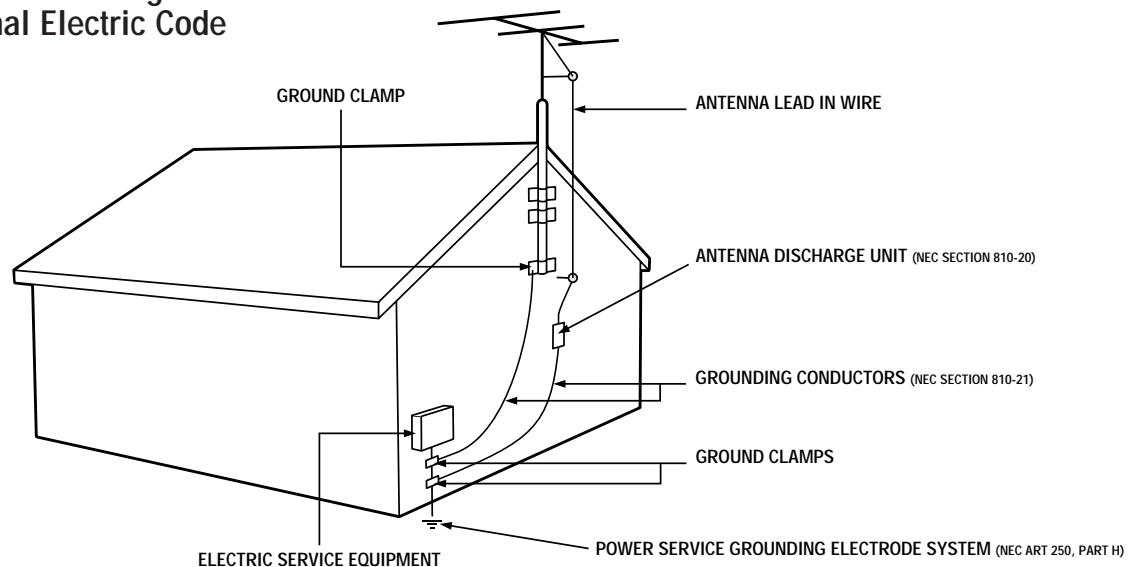

TABLE OF CONTENTS

Introduction

Welcome/Registration of Your TV	2
Safety/Precautions	3
Table of Contents	4
Features	5



Onscreen MENU

Picture

◇ Adjusting the TV Picture	6
----------------------------------	---

Features

◇ Setting the TV's Onscreen Clock	7
◇ Activating the TV's On Timer Control.....	8
◇ Selecting the TV's On Timer Channel	9
◇ Selecting the TV's On Timer Tuner	10
◇ Setting the TV's On Timer Startup Time.....	11
◇ Turning on the On Timer Display.....	12
◇ Understanding SmartLock™.....	13
◇ Using SmartLock - Setting Up the Access Code	14
◇ Using SmartLock - Block Channels	15
◇ Using SmartLock - Movie Rating.....	16
◇ Using SmartLock - TV Rating	17
◇ Using SmartLock - Blocking	18
◇ Using SmartLock - Block Unrated	19
◇ Using SmartLock - No Rating	20
◇ Reviewing the SmartLock Settings.....	21
◇ Viewing Blocked Programming.....	22
◇ Using the Dynamic Noise Reduction (DNR) Control	23
◇ Turning On the Contrast + (Black Stretch) control	23
◇ Using the Incredible Picture Control.....	24
◇ Setting the TV for Closed Caption	25
◇ Using the Sleep Timer Control.....	26

Sound

◇ Adjusting the Treble, Bass, and Balance Sound Controls.....	27
◇ Setting the TV for Stereo and SAP Programs ..	28
◇ Using the Incredible Stereo Control	29
◇ Using the Volume Bar Control	29
◇ Using the Audio Out Jacks (with TV Speaker On/Off Control)	30
◇ Using Surround Sound External Speakers	31
◇ Using the TV's Audio/Video Input Jacks	32-33



Remote Control Operation

Using the Remote Locator Feature	34-35
Using the SmartPicture™ Control	36
Using the SmartSound™ Control (AVL)	37
Using the Surf and Alternate Channel Buttons	38
Setting the Remote to Operate Accessory Devices	39-40
Setting the TV Remote to Operate Accessory Devices (Search Method)	41
Remote Control Direct Entry Code List	42-43
Using the Remote's VCR Buttons	44



Picture-In-Picture (PIP)

PIP Connection	45
Choosing the PIP Picture Source	46
How to Use PIP with the TV Remote	47
Adjusting the PIP Color and Tint Controls	48
More PIP Connections.....	49-50



General Information

Tips if Something Isn't Working	51
Glossary of TV Terms.....	52
Index	53
Factory Service Locations	54-55
Warranty.....	56

SmartClock, SmartLock, SmartPicture, and SmartSound are trademarks of Philips Consumer Electronics Company.
Copyright © 1999 Philips Consumer Electronics Company. All rights reserved.

FEATURES

Infrared Remote Control works your TV set, VCR, and a variety of wireless remote control Cable Converters (Satellite Receivers, DVD, etc.).

Standard broadcast (VHF/UHF) or Cable TV (CATV) channel capability.

Stereo Ready TV with built-in audio amplifier and twin speaker system for receiving TV programs broadcast in stereo sound.

Closed Captioning allows the viewer to read TV program dialogue or voice conversations as onscreen text.

Automatic Programming of Channels for quick and easy selection of favorite stations available in your area.

Onscreen Features (in either English, French, or Spanish) show helpful messages for setting of TV controls.

Audio/Video Jackpanel for direct connections with VCRs (or other video accessories) providing quality TV picture and sound playback.

Twin Antenna (A/B) Inputs for easy displaying of two separate signal sources on the TV. An A/B button on the remote control switches the TV's Main screen between the two Antenna (A & B) Input options.

Surround Sound external speaker connections allow you hook your TV to external audio equipment for more dynamic sound replay and audio effects.

On Timer automatically turns the TV ON at a preset time, and channel.

Sleep-Timer automatically turns the TV OFF at preset times.

SmartLock feature allows you to block the viewing of certain channel or external audio/video connections were you might not want your children viewing inappropriate material.

SmartPicture allows you to change the picture settings (color, tint, contrast, etc.) for various types of programming, such as Sports, Movies, Multimedia (Games), or Weak Signals, with the push of one button.

SmartSound controls the sudden volume changes during program changes and commercials. It eliminates the peaks and valleys in the TV's sound and creates one pleasant listening level. You also may tailor the SmartSound setting to the type of program you are watching (Music, Theatre, etc.).

Picture-In-Picture (PIP) allows you view to different programs (or picture sources) on the TV screen at the same time. PIP will also let you swap the pictures, move the PIP picture to any of the four corners, and even freeze the picture until you shut it off.

SET-UP AND QUICK USE GUIDE

Use the simple Set-Up Guide (supplied with your TV information packet) for details on:

- Cable/Antenna Hook-ups
- Auto-Programming of Channels
- Channel Editing
- Automatic Clock Setting (Smart Clock)
- Basic TV and Remote Control Operation
- onscreen Menu Use

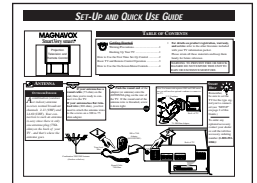

NOTE: This owner's manual content is used with several different television models. Not all features (and drawings) discussed in this manual will necessarily match those found with your television system. This is normal and does not require you contacting your dealer or requesting service.

END-OF-LIFE DISPOSAL

Your new television and its packing contain materials that can be recycled and reused. Specialized companies can recycle your product to increase the amount of reusable materials and minimize the amounts which need to be properly disposed.

Your product also uses batteries which should not be thrown away when depleted, but should be disposed of as small chemical waste.

Please find out about the local regulations on how to dispose of your old television, batteries, and packing materials whenever you replace existing equipment.

HOW TO ADJUST THE TV PICTURE

To adjust your TV picture controls, select a channel and follow the steps shown below:

BEGIN

- 1 Press the **MENU** button on the remote to show the on-screen menu. Press the **CURSOR DOWN** button on the remote to highlight the word **PICTURE**.
- 2 Press the **CURSOR RIGHT** button and the menu will shift to the right to display an adjustment bar in front of the **BRIGHTNESS** control.
- 3 Use the **CURSOR LEFT** or **RIGHT** buttons to adjust the **BRIGHTNESS** level of the picture.
- 4 After adjusting the **BRIGHTNESS** control, press the **CURSOR DOWN** button to select another Picture adjustment: **COLOR**, **PICTURE**, **SHARPNESS**, **TINT**, or **COLOR TEMP**. Use the **CURSOR LEFT** or **CURSOR RIGHT** buttons to adjust the selected control.
- 5 Press the **STATUS/EXIT** button to remove the menu from the screen.



SMART HELP



Remember, when the bar scale is centered, the control settings are at normal mid-range levels.

BRIGHTNESS Press the **▶▶** or **◀◀** buttons until darkest parts of the picture are as bright as you prefer.

COLOR Press the **▶▶** or **◀◀** buttons to add or eliminate color.

PICTURE Press the **▶▶** or **◀◀** buttons until lightest parts of the picture show good detail.

SHARPNESS Press the **▶▶** or **◀◀** buttons to improve detail in the picture.

TINT Press the **▶▶** or **◀◀** buttons to obtain natural skin tones.

COLOR TEMP Press the **▶▶** or **◀◀** buttons to select **NORMAL**, **COOL**, or **WARM** picture preferences. (**NORMAL** will keep the whites, white; **COOL** will make the whites, bluish; and **WARM** will make the whites, reddish.)

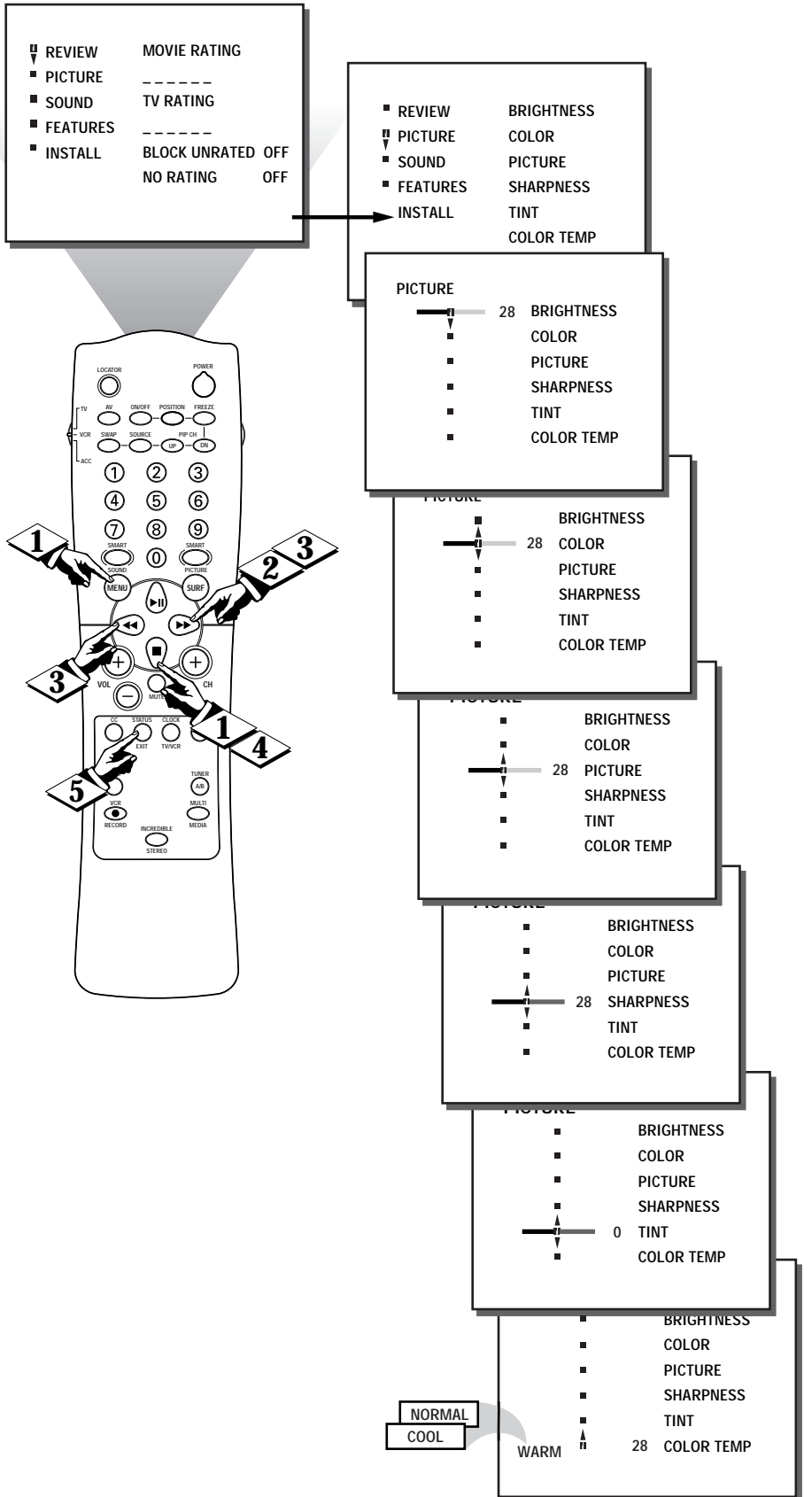

SETTING THE TV'S CLOCK

Your television comes with an onscreen clock. During normal operation the clock appears on the screen when the STATUS/EXIT button is pressed or if the Timer DISPLAY control is turned ON.

BEGIN

- 1 Press the **MENU** button on the remote to show the onscreen menu.
- 2 Press the **CURSOR DOWN** button until the word **FEATURES** is highlighted.
- 3 Press the **CURSOR RIGHT** button and the menu will shift to the left to display the **TIMER** controls.
- 4 Press the **CURSOR RIGHT** button again to shift the display left and highlight the **TIME** control.
- 5 Press the **CURSOR RIGHT** button again to highlight the time indicator area.
- 6 Press the **NUMBERED** buttons to enter the correct time. (Use the **CURSOR UP** or **CURSOR DOWN** buttons to set AM or PM.)



SMART HELP



Remember, be sure to press "0" first and then the hour number for single digit entries.

The Clock can also be set automatically using the Smart Clock feature found on page 2 of the Quick Use Guide.

The television's clock settings may be lost when it is unplugged (or AC power to the set is interrupted.)

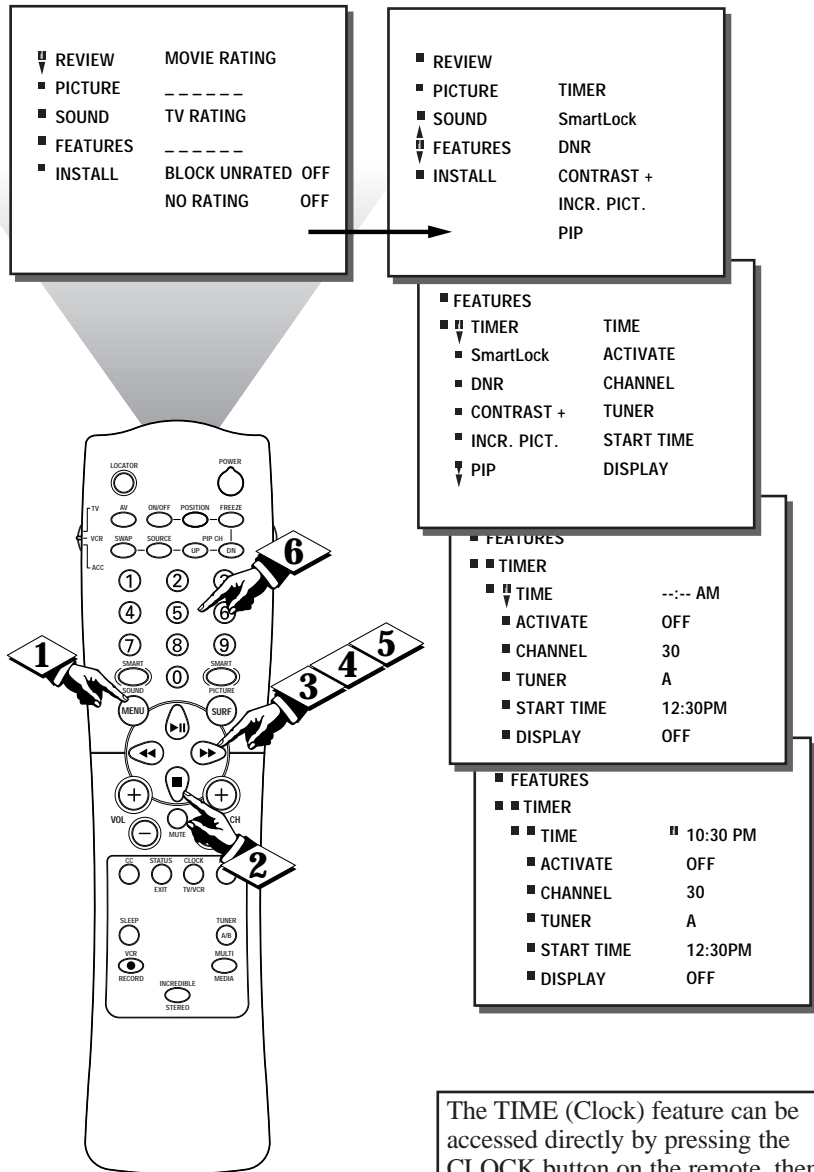

The TIME (Clock) feature can be accessed directly by pressing the CLOCK button on the remote, then simply follow steps 5 and 6 to complete the task.

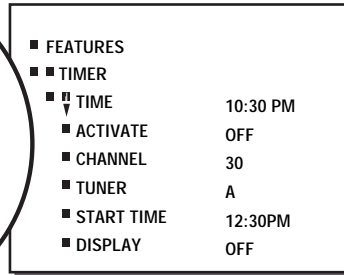
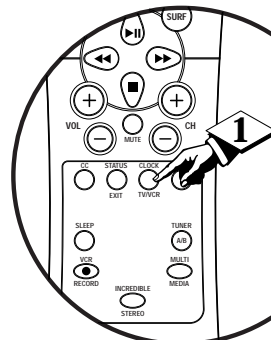

ACTIVATING THE TV'S ON TIMER CONTROL

Just like an alarm clock you can set the TV to turn itself on at the same time everyday.

BEGIN

- 1 Press the **MENU** button on the remote to show the onscreen menu.
- 2 Press the **CURSOR DOWN** button until the word **FEATURES** is highlighted.
- 3 Press the **CURSOR RIGHT** button and the menu will shift to the left to display the **TIMER** controls.
- 4 Press the **CURSOR RIGHT** button again to shift the display left, then **CURSOR DOWN** to highlight the **ACTIVATE** timer control.
- 5 Press the **CURSOR RIGHT** button again to highlight the **ACTIVATE** timer option. Then, press the **CURSOR UP** or **CURSOR DOWN** buttons to turn the timer ON or OFF.



SMART HELP

Remember, be sure to set the time you want the television to turn on using the **START TIME** control as described on page 10.

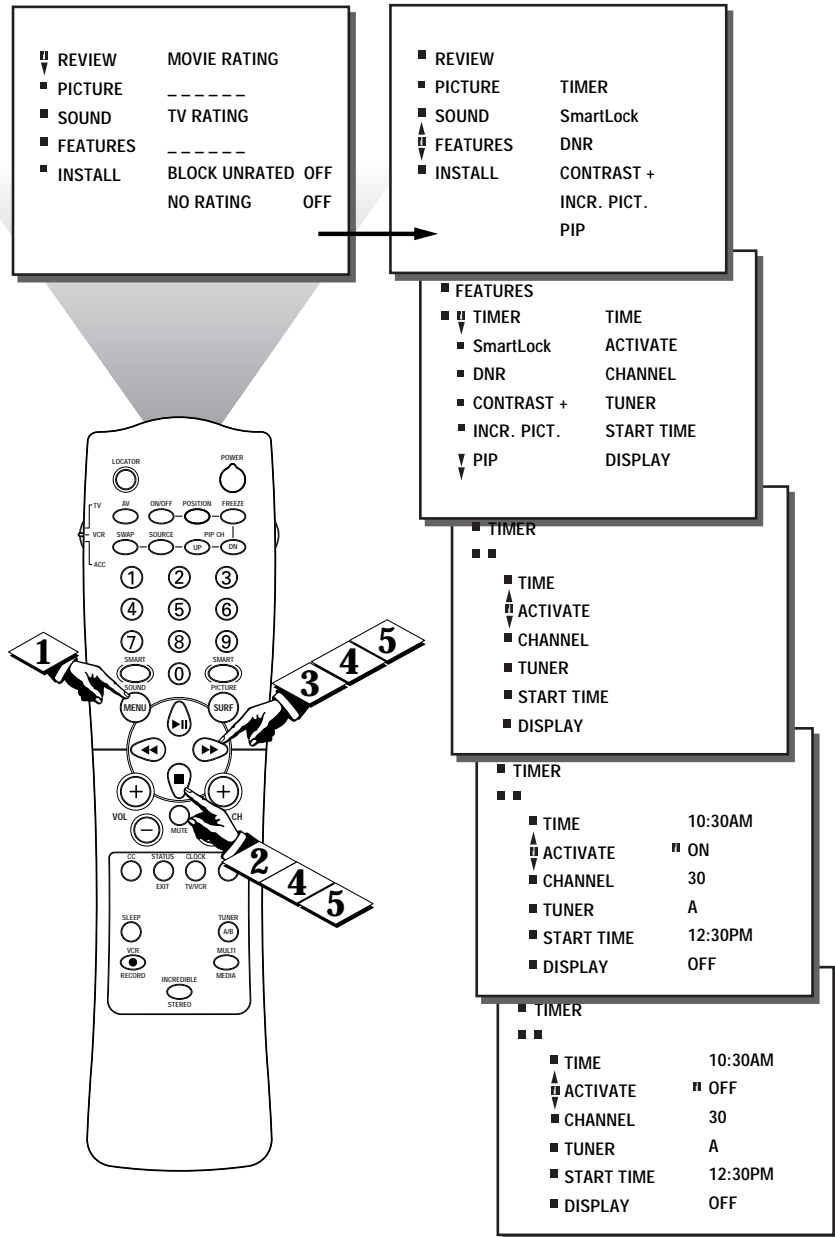

SELECTING THE TV'S ON TIMER CHANNEL



Used along with the on timer feature, you can select a specific channel that the television will tune to when the Timer **ACTIVATE** control is turned **ON**.

BEGIN

- 1 Press the **MENU** button on the remote to show the onscreen menu.
- 2 Press the **CURSOR DOWN** button until the word **FEATURES** is highlighted.
- 3 Press the **CURSOR RIGHT** button and the menu will shift to the left to display the **TIMER** controls.
- 4 Press the **CURSOR RIGHT** button again to shift the display left, then **CURSOR DOWN** to highlight the **CHANNEL** control.
- 5 Press the **CURSOR RIGHT** button again to highlight the channel indicator area.
- 6 Press the **NUMBERED** buttons to enter the desired start up channel. (Or, use the **CHANNEL (+) or (-)** buttons to select the desired channel.)



SMART HELP



Remember, be sure to turn the **Timer ACTIVATE** control **ON** after selecting the desired start up channel. (Refer to page 8 for further details.)

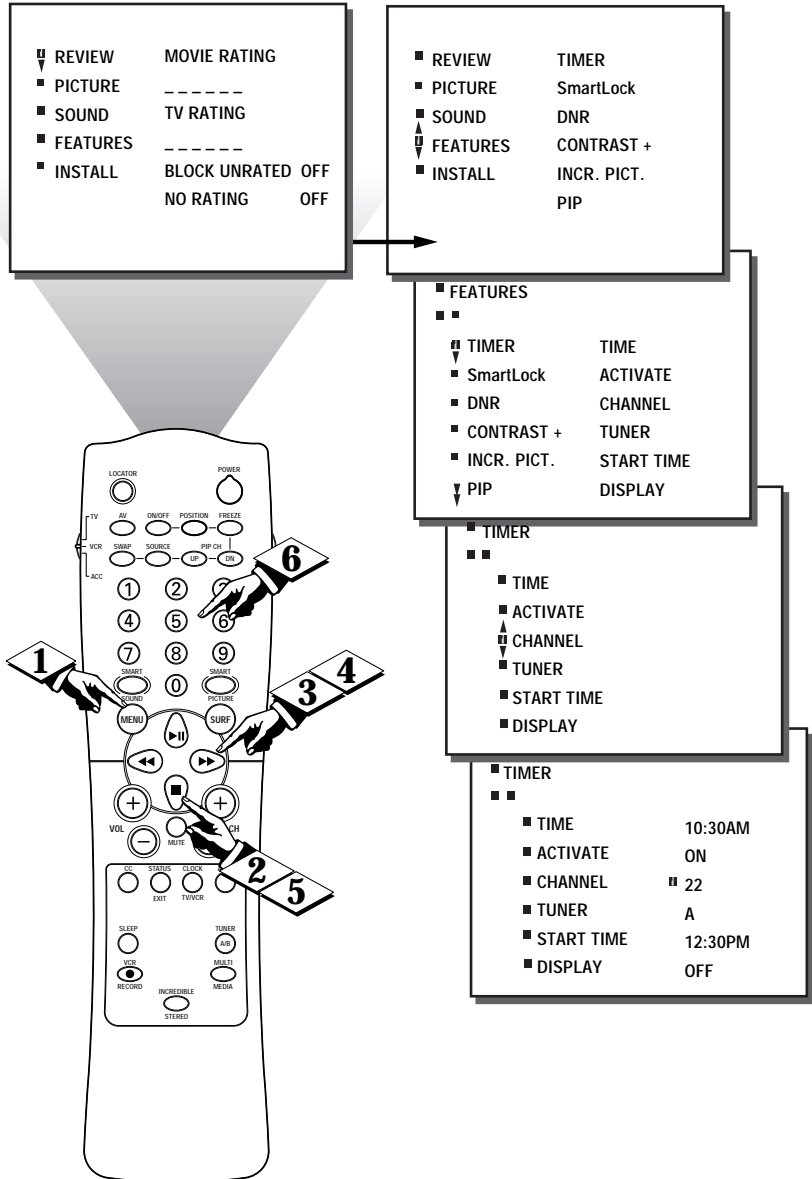

SETTING THE TV'S ON TIMER TUNER

Your TV is equipped with two tuners. The TV can be programmed to tune to either ANT A or PIP ANT B when the on timer is set.

BEGIN

- 1 Press the **MENU** button on the remote to show the onscreen menu.
- 2 Press the **CURSOR DOWN** button until the word **FEATURES** is highlighted.
- 3 Press the **CURSOR RIGHT** button and the menu will shift to the left to display the **TIMER** controls.
- 4 Press the **CURSOR RIGHT** button again to shift the display left.
- 5 Press the **CURSOR DOWN** button to highlight the **TUNER** control.
- 6 Press the **CURSOR RIGHT** button again to highlight the **TUNER A** or **B** control options.
- 7 Press the **CURSOR UP** or **CURSOR DOWN** buttons to select the "A" or "B" tuner inputs.

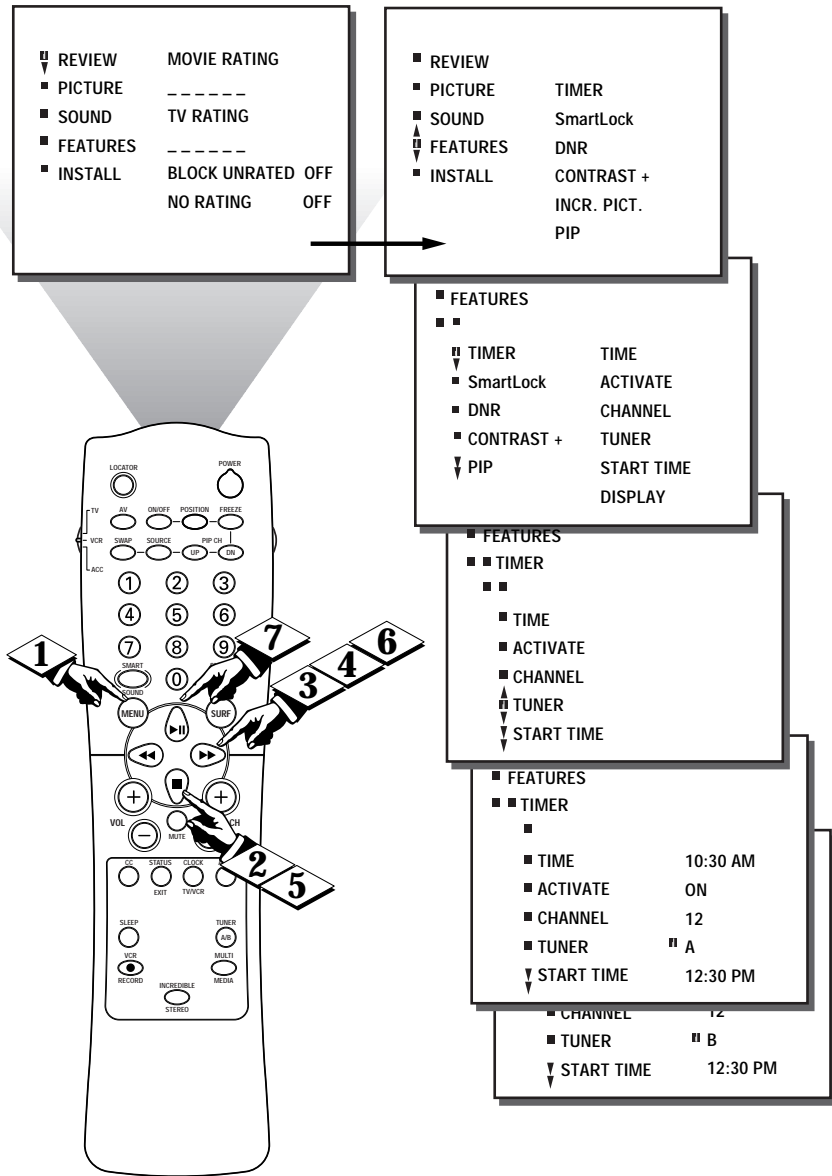

SETTING THE TV'S ON TIMER START TIME

Used along with the on timer feature, you can select a specific time the television will turn on when the Timer **ACTIVATE** control is turned **ON**.

BEGIN

- 1 Press the **MENU** button on the remote to show the onscreen menu.
- 2 Press the **CURSOR DOWN** button until the word **FEATURES** is highlighted.
- 3 Press the **CURSOR RIGHT** button and the menu will shift to the left to display the **TIMER** controls.
- 4 Press the **CURSOR RIGHT** button again to shift the display left, then **CURSOR DOWN** to highlight the **START TIME** control.
- 5 Press the **CURSOR RIGHT** button again to highlight the time indicator area.
- 6 Press the **NUMBERED** buttons to enter the desired start up time. (Use the **CURSOR UP** or **CURSOR DOWN** buttons to set **AM** or **PM**.)



SMART HELP

Remember, be sure to turn the **Timer ACTIVATE** control **ON** after setting the desired start up time. (Refer to page 8 for further details.)

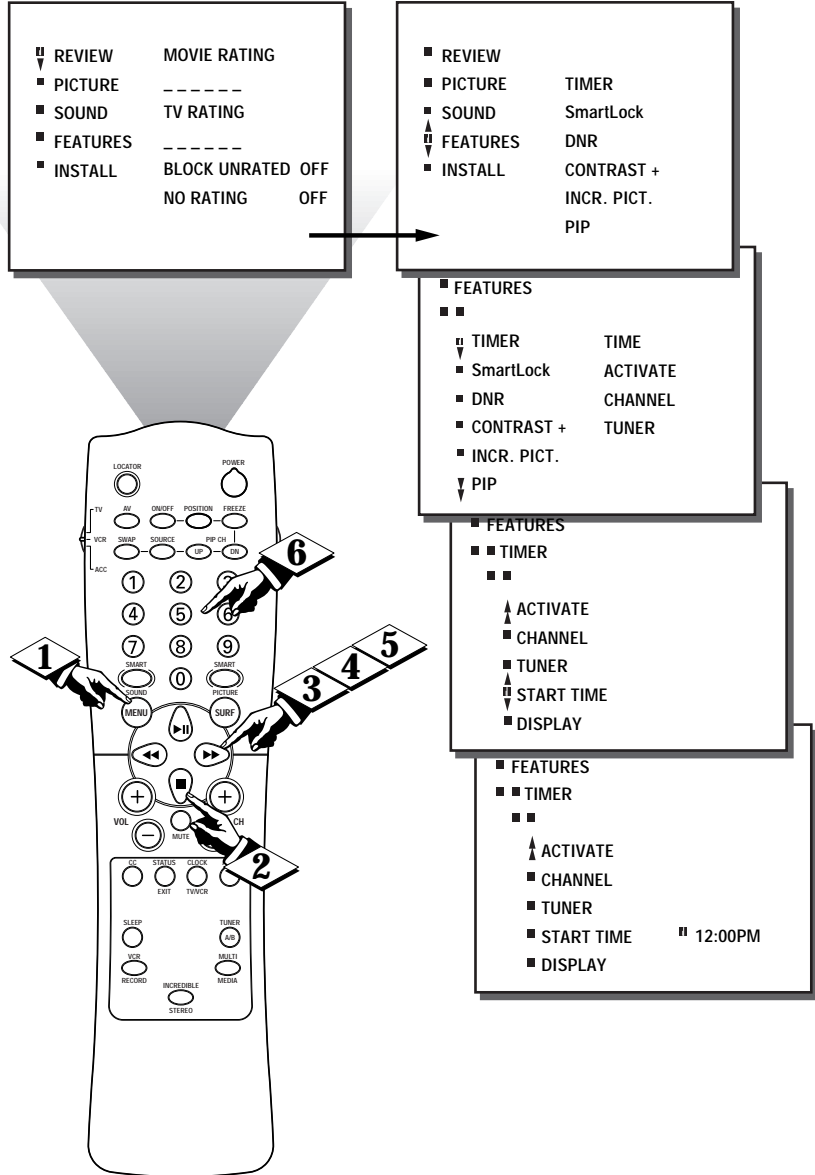

SETTING THE TV'S ON TIMER DISPLAY

Once the television clock has been set, you can use your television as a clock. The **Timer DISPLAY** control allows you to permanently display the time in the upper right corner of the screen.

BEGIN

- 1 Press the **MENU** button on the remote to show the onscreen menu.
- 2 Press the **CURSOR DOWN** button until the word **FEATURES** is highlighted.
- 3 Press the **CURSOR RIGHT** button and the menu will shift to the left to display the **TIMER** controls.
- 4 Press the **CURSOR RIGHT** button again to shift the display left, then **CURSOR DOWN** to highlight the **DISPLAY** control.
- 5 Press the **CURSOR RIGHT** button again to highlight the **DISPLAY** control options. Then, press the **CURSOR UP** or **CURSOR DOWN** buttons to turn the timer ON or OFF.



SMART HELP



Remember, be sure you have set the television's clock with the correct current time. (Refer to page 7 to set the Clock Manually or page 4 of the Quick Use Guide to set the Clock Automatically using the Smart Clock feature.)

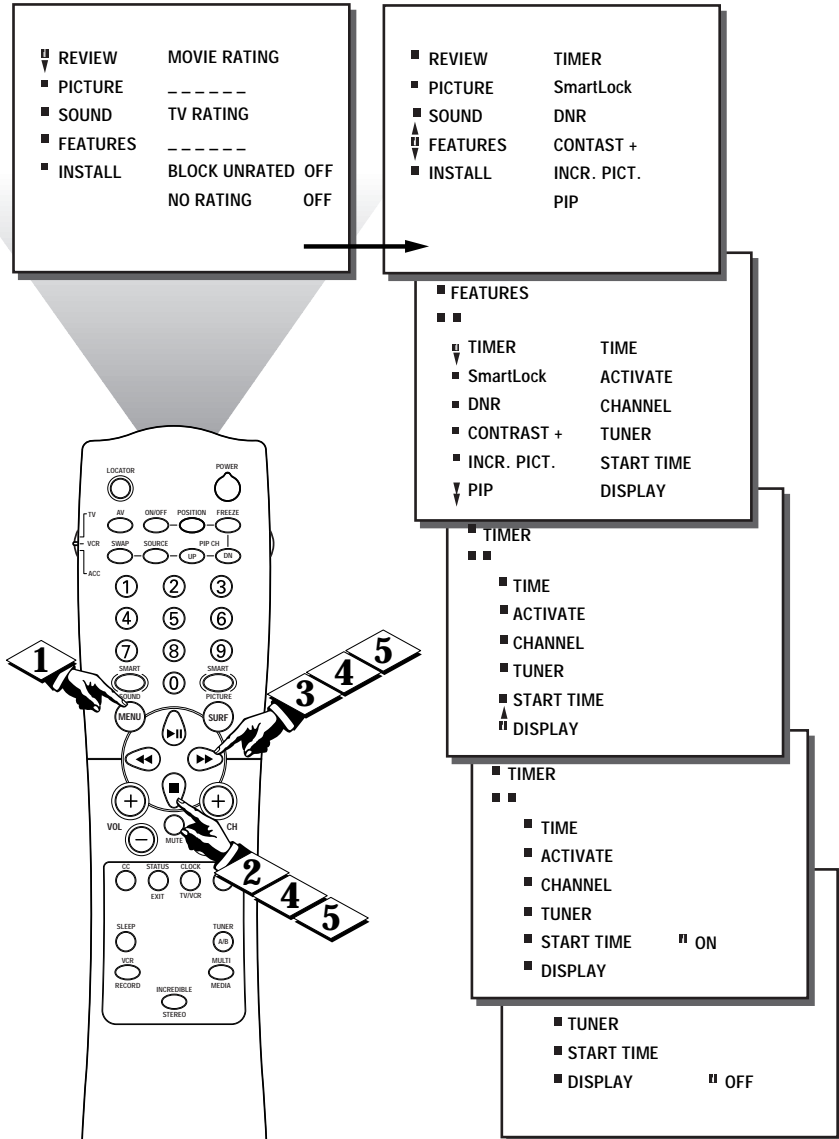



The SmartLock feature receives and processes data sent by broadcasters, or other program providers, that contain program content advisories. When programmed by the viewer, a TV with SmartLock can respond to the content advisories and block program content that may be found objectionable (such as offensive language, violence, sexual situations, etc.). This is a great feature to censor the type of programming children may watch.

Over the next few pages, you'll learn how to block channels and certain rated programming, as well as learn to turn these blocking features on or off. Below is a brief explanation of some terms and ratings you will find in the SmartLock feature.

SmartLock offers various Blocking Options from which to choose:

BLOCKING: This is what might be called the "master switch" for SmartLock. When BLOCKING is OFF, ALL blocking/censoring is disabled. When BLOCKING is ON, ALL blocking based on specific settings will take place.

BLOCK UNRATED: ALL unrated programs will be blocked if this feature is set to ON.

UNRATED programming is encoded with information from the MPAA or TV broadcasters, but it does not have a specific rating. In other words, the MPAA or the TV broadcasters have chosen not to assign a rating to the programming.

NO RATING: ALL programming with no content advisory data can be blocked if NO RATING is set to ON.

Programming that has No Rating is not encoded with any rating information from the MPAA or the Parental Guidelines. Any program could fall into this category.

You also can block individual channels or block programming based on ratings of the MPAA and TV broadcasters. (See description of ratings on this page.)

- FEATURES
 - SmartLock
 - ■
 - BLOCK CHANNEL
 - SETUP CODE G
 - ▲ MOVIE RATING PG
 - ▼ TV RATING PG-13
 - BLOCK OPTIONS R

- FEATURES
 - SmartLock
 - ■
 - BLOCK CHANNEL
 - SETUP CODE TV-Y
 - MOVIE RATING TV-Y7
 - ▲ TV RATING TV-G
 - ▼ BLOCK OPTIONS TV-PG

MOVIE RATINGS

(MOTION PICTURE ASSOCIATION OF AMERICA)

G: General Audience - All ages admitted. Most parents would find this program suitable for all ages. This type of programming contains little or no violence, no strong language, and little or no sexual dialogue or situations.

PG: Parental Guidance Suggested - This programming contains material that parents may find unsuitable for younger children. It may contain one or more of the following: Moderate violence, some sexual situations, infrequent coarse language, or some suggestive dialogue.

PG-13: Parents Strongly Cautioned - This programming contains material that parents may find unsuitable for children under the age of 13. It contains one or more of the following: violence, sexual situations, coarse language, or suggestive dialogue.

R: Restricted - This programming is specifically designed for adults. Anyone under the age of 17 should only view this programming with an accompanying parent or adult guardian. It contains one or more of the following: intense violence, intense sexual situations, strong coarse language, or intensely suggestive dialogue.

NC-17: No one under the age of 17 will be admitted. - This type of programming should be viewed by adults only. It contains graphic violence, explicit sex, or crude indecent language.

X: Adults Only - This type of programming contains one or more of the following: very graphic violence, very graphic and explicit or indecent sexual acts, very coarse and intensely suggestive language.

TV PARENTAL GUIDELINES (TV BROADCASTERS)

TV Y **TV-Y - (All children** -- This program is designed to be appropriate for all children.) Designed for a very young audience, including children ages 2-6. This type of programming is not expected to frighten younger children.

TV Y7 **TV-Y7 - (Directed to Older Children** -- This program is designed for children age 7 and above.) It may be more appropriate for children who have acquired the development skills needed to distinguish between make-believe and reality. This programming may include mild fantasy and comic violence (FV).

TV G **TV-G - (General Audience** -- Most parents would find this program suitable for all ages.) This type of programming contains little or no violence, no strong language, and little or no sexual dialogue or situations.

TV PG **TV-PG - (Parental Guidance Suggested** -- This program contains material that parents may find unsuitable for younger children.) This type of programming contains one or more of the following: Moderate violence (V), some sexual situations (S), infrequent coarse language (L), or some suggestive dialogue (D).

TV 14 **TV-14 - (Parents Strongly Cautioned** -- This program contains some material that many parents would find unsuitable for children under 14 years of age.) This type of programming contains one or more of the following: intense violence (V), intense sexual situations (S), strong coarse language (L), or intensely suggestive dialogue (D).

TV MA **TV-MA - (Mature Audience Only** -- This program is specifically designed to be viewed by adults and therefore may be unsuitable for children under 17.) This type of programming contains one or more of the following: graphic violence (V), explicit sexual situations (S), or crude indecent language (L).

USING SMARTLOCK - SETTING UP THE ACCESS CODE

SmartLock allows parents to block out or "censor" any channels they think children should not watch. A channel blocked by the SmartLock control cannot be viewed until a correct access code is used to unlock the channel for viewing. First let's set your SmartLock access code:

BEGIN

- 1 Press the **MENU** button on the remote to show the on-screen menu.
- 2 Press the **CURSOR DOWN** button until the word **FEATURES** is highlighted.
- 3 Press the **CURSOR RIGHT** button and the menu will shift to the left, then **CURSOR DOWN** to highlight the **SmartLock** control.
- 4 Press the **CURSOR RIGHT** button again to shift the display left.
- 5 "Enter current access code" will appear within the menu. Press **0, 7, 1, 1** on the remote. "XXXX Code Correct" will appear. If you enter the wrong code, "XXXX Incorrect - Please re-enter access code" will appear. Re-enter the 0, 7, 1, 1 code on the remote. "XXXX Code Correct" will appear.
- 6 Press the **CURSOR DOWN** button to highlight **SETUP CODE**, then press the **CURSOR RIGHT** button.
- 7 You will be asked to enter the current access code again. Press **0711** on the remote control. "XXXX Code correct" will appear.
- 8 "Next enter your new access code" shows on the screen. Press the **NUMBERED** buttons on the remote to enter a **NEW** four digit code. Reenter the code for confirmation. "XXXX Code changed" shows on the screen to let you know the new code has been set.
- 9 Press the **STATUS/EXIT** button to remove the menu from the screen.

Parents - it's not possible for your child to unblock a channel without knowing your access code or changing it to a new one. If your code changes, and you didn't change it, then you know it's been altered by someone else and blocked channels have been viewed.

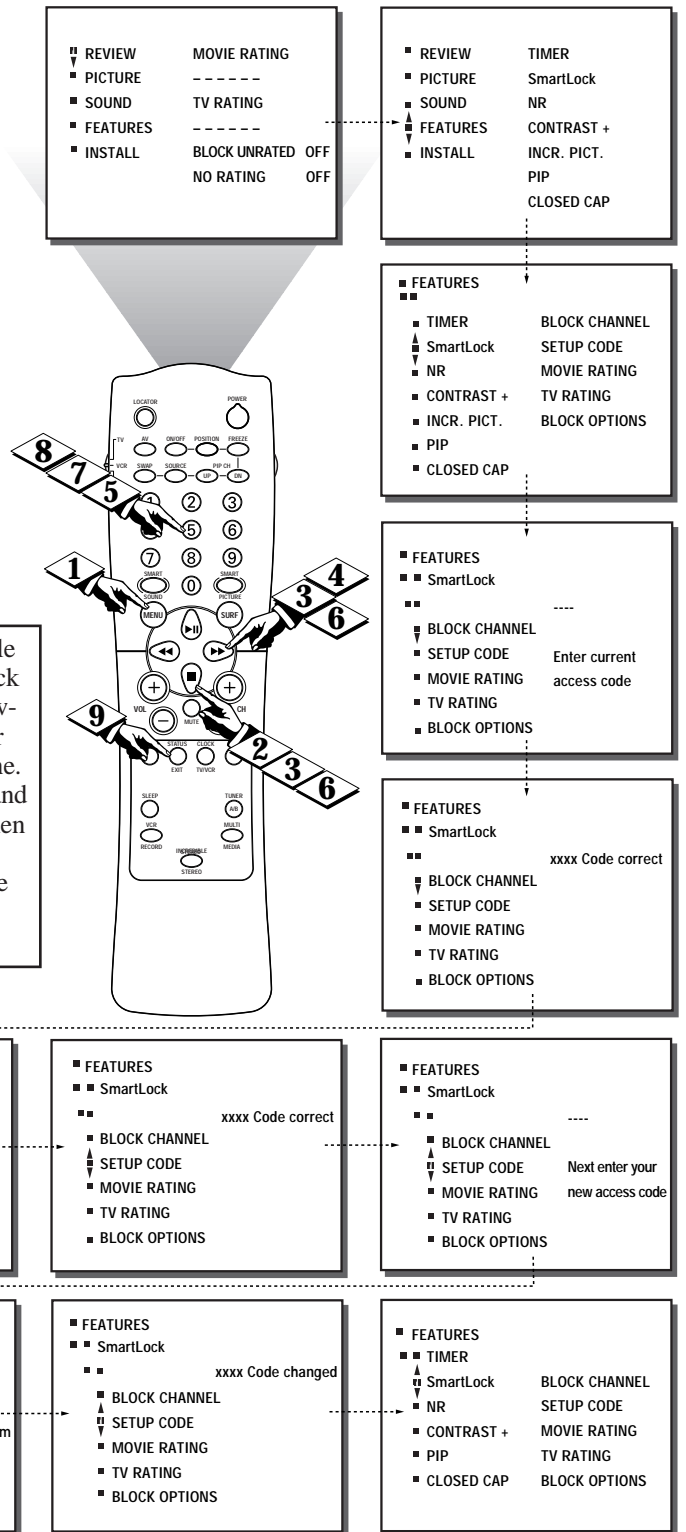

USING SMARTLOCK - BLOCKING CHANNELS



After your personal access code has been set (see previous page), you are now ready to select the channels or inputs you want to block out or censor.

BEGIN

- 1 Press the **MENU** button on the remote to show the on-screen menu.
- 2 Press the **CURSOR DOWN** button until the word **FEATURES** is highlighted.
- 3 Press the **CURSOR RIGHT** button and the menu will shift to the left, then **CURSOR DOWN** to highlight the **SMARTLOCK** control.
- 4 Press the **CURSOR RIGHT** button again to shift the display left. "---- Enter current access code" will appear within the menu.
- 5 Enter the correct access code number. "XXXX" shows on the screen as you press the **NUMBERED** buttons. "XXXX Code correct" will appear, then the **BLOCK CHANNEL** control will be highlighted.
- 6 Press the **CURSOR RIGHT** button. You will be asked to enter your access code again. Enter your access code.
- 7 Press the **CHANNEL (+) or (-) buttons** (or **NUMBERED** buttons) to select the channel you want to block.
- 8 Press the **CURSOR RIGHT** button to block viewing of the channel, or the press the **CURSOR LEFT** button to allow viewing of the channel.

Repeat steps 7 and 8 for any other channels you wish to block from viewing or press the **STATUS/EXIT** button to remove the menu from the screen.



Note: Blocked channels will be skipped when you press the Channel +/- buttons. To view a blocked channel, use the Numbered buttons to access the channel. See page 22 for details.

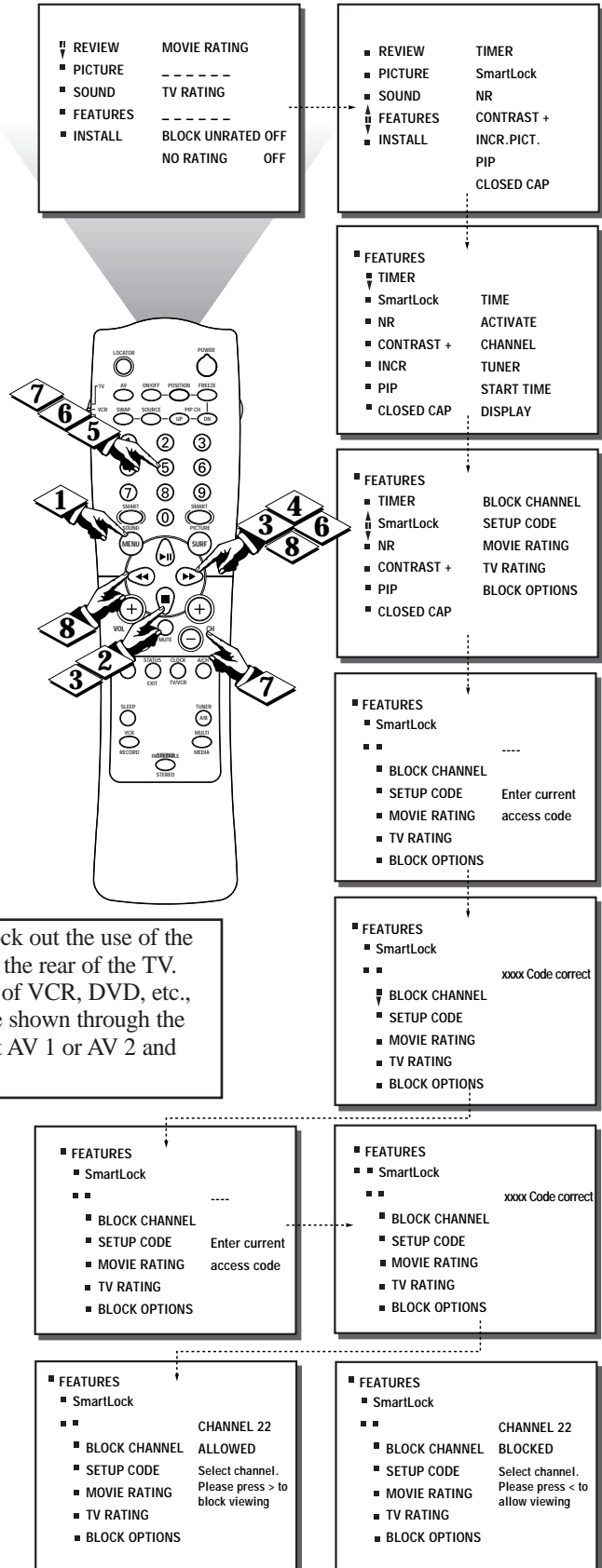

Note: You can also block out the use of the A/V external inputs on the rear of the TV. This stops the viewing of VCR, DVD, etc., programs which can be shown through the A/V Input jacks. Select AV 1 or AV 2 and select block.

USING SMARTLOCK - MOVIE RATING

After your personal access code has been set (see page 13), you may select specific movie ratings that you want to censor.

BEGIN

- 1 Press the **MENU** button on the remote to show the on-screen menu.
 - 2 Press the **CURSOR DOWN** button until the word **FEATURES** is highlighted.
 - 3 Press the **CURSOR RIGHT** button to shift the menu to the left, then press the **CURSOR DOWN** button to highlight the **SMARTLOCK** control.
 - 4 Press the **CURSOR RIGHT** button again to shift the display left. "---- Enter current access code" will appear within the menu.
 - 5 Enter the correct access code number. "XXXX" shows on the screen as you press the **NUMBERED** buttons. "XXXX Code correct" will appear, then the **BLOCK CHANNEL** control will be highlighted.
 - 6 Press the **CURSOR DOWN** button to select **MOVIE RATING**.
 - 7 Press the **CURSOR RIGHT** button to access the movie ratings.
 - 8 Press the **CURSOR UP** button or the **CURSOR DOWN** button to select a rating.
 - 9 Press the **CURSOR RIGHT** button or the **CURSOR LEFT** button to turn the block on the rating **ON** or **OFF**.
- Repeat steps 8 and 9 to turn **ON** or **OFF** the block for other ratings.
- 10 Press the **STATUS/EXIT** button to remove the menu.

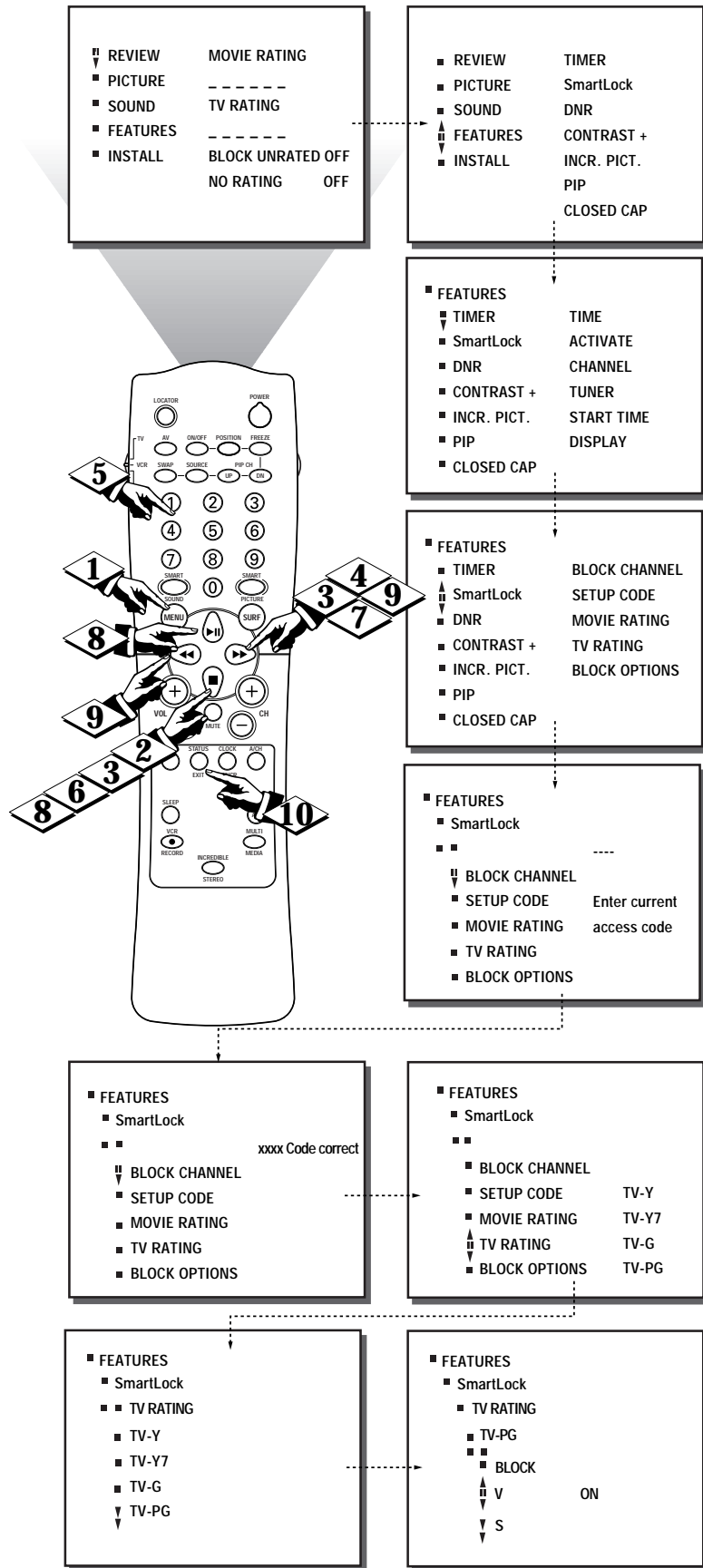

USING SMARTLOCK - TV RATING



You also may select specific television ratings that you want to censor.

BEGIN

- 1 Press the **MENU** button on the remote to show the on-screen menu.
- 2 Press the **CURSOR DOWN** button until the word **FEATURES** is highlighted.
- 3 Press the **CURSOR RIGHT** button to shift the menu to the left, then press the **CURSOR DOWN** button to highlight the **SMARTLOCK** control.
- 4 Press the **CURSOR RIGHT** button again to shift the display left. "---- Enter current access code" will appear within the menu.
- 5 Enter the correct access code number. "XXXX" shows on the screen as you press the **NUMBERED** buttons. "XXXX Code correct" will appear, then the **BLOCK CHANNEL** control will be highlighted.
- 6 Press the **CURSOR DOWN** button to select **TV RATING**.
- 7 Press the **CURSOR RIGHT** button to access the television ratings.
- 8 Press the **CURSOR UP** button or the **CURSOR DOWN** button to select a rating.
- 9 Press the **CURSOR RIGHT** button or the **CURSOR LEFT** button to turn the block on the rating ON or OFF.

More specific sub-ratings (for violence, sexual content, dialogue, or fantasy violence) are available for TV-Y7, TV-PG, TV-14, and TV-MA. To access these sub-ratings, press the **CURSOR RIGHT** button. Press the **CURSOR UP** or **CURSOR DOWN** buttons to select the sub-rating that you want to block or unblock. Then, press the **CURSOR RIGHT** button or the **CURSOR LEFT** button to turn the block on the sub-rating ON or OFF.

- 10 Press the **STATUS/EXIT** button to remove the menu.

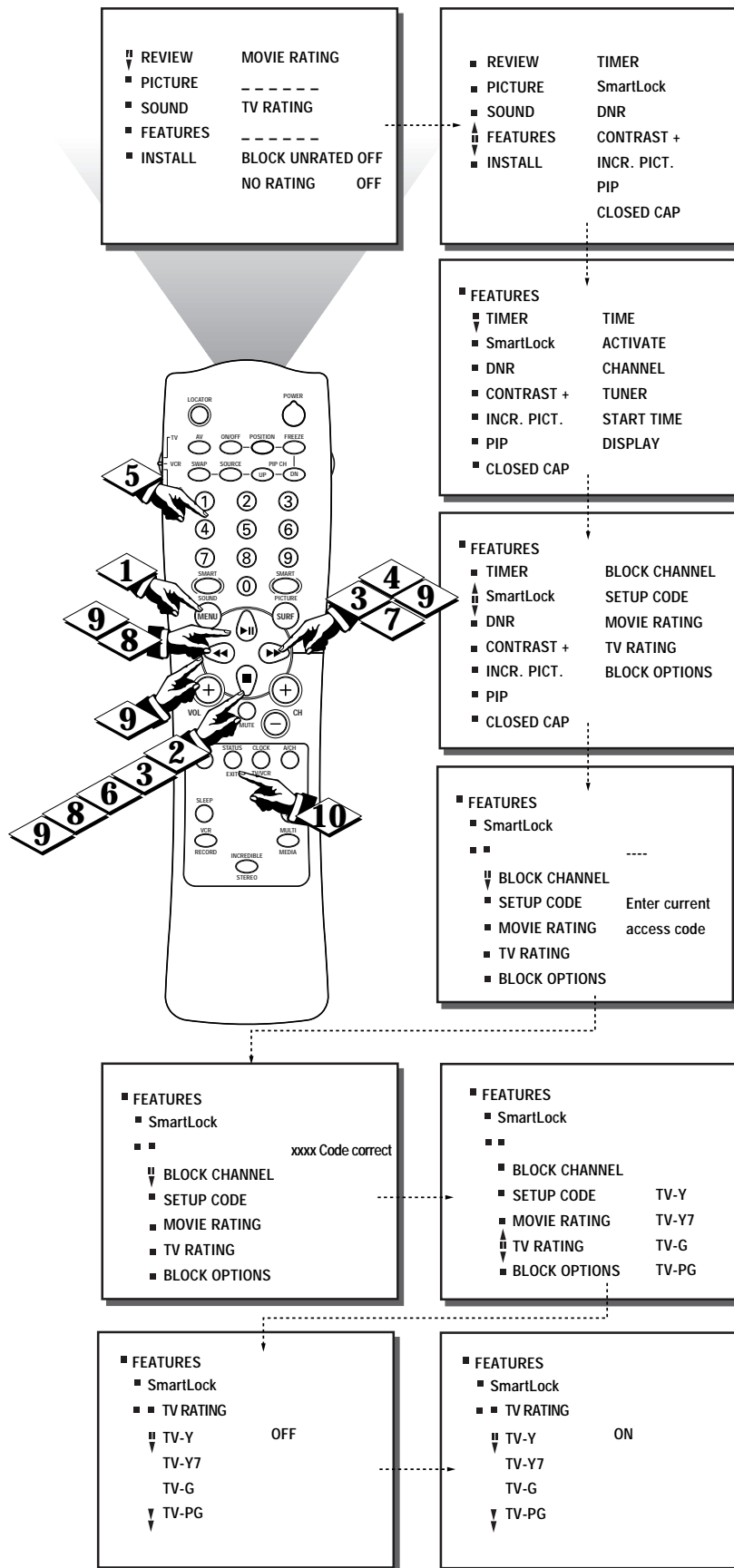

USING SMARTLOCK - BLOCKING

After you block specific channels or ratings, you must set **BLOCKING to ON or OFF** in order to activate the blocking. To set **BLOCKING to ON or OFF**, follow these steps.

BEGIN

1 Press the **MENU** button on the remote to show the on-screen menu.

2 Press the **CURSOR DOWN** button until the word **FEATURES** is highlighted.

3 Press the **CURSOR RIGHT** button to shift the menu to the left, then press the **CURSOR DOWN** button to highlight the **SMARTLOCK** control.

4 Press the **CURSOR RIGHT** button again to shift the display left. "---- Enter current access code" will appear within the menu.

5 Enter the correct access code number. "XXXX" shows on the screen as you press the **NUMBERED** buttons. "XXXX Code correct" will appear, then **BLOCK CHANNEL** will be highlighted.

6 Press the **CURSOR DOWN** button to select **BLOCK OPTIONS**.

7 Press the **CURSOR RIGHT** button to shift the menu to the left and see the options. **BLOCKING** will be highlighted.

8 Press the **CURSOR RIGHT** button or the **CURSOR LEFT** button to set **BLOCKING to ON or OFF**.

9 Press the **STATUS/EXIT** button to remove the menu.

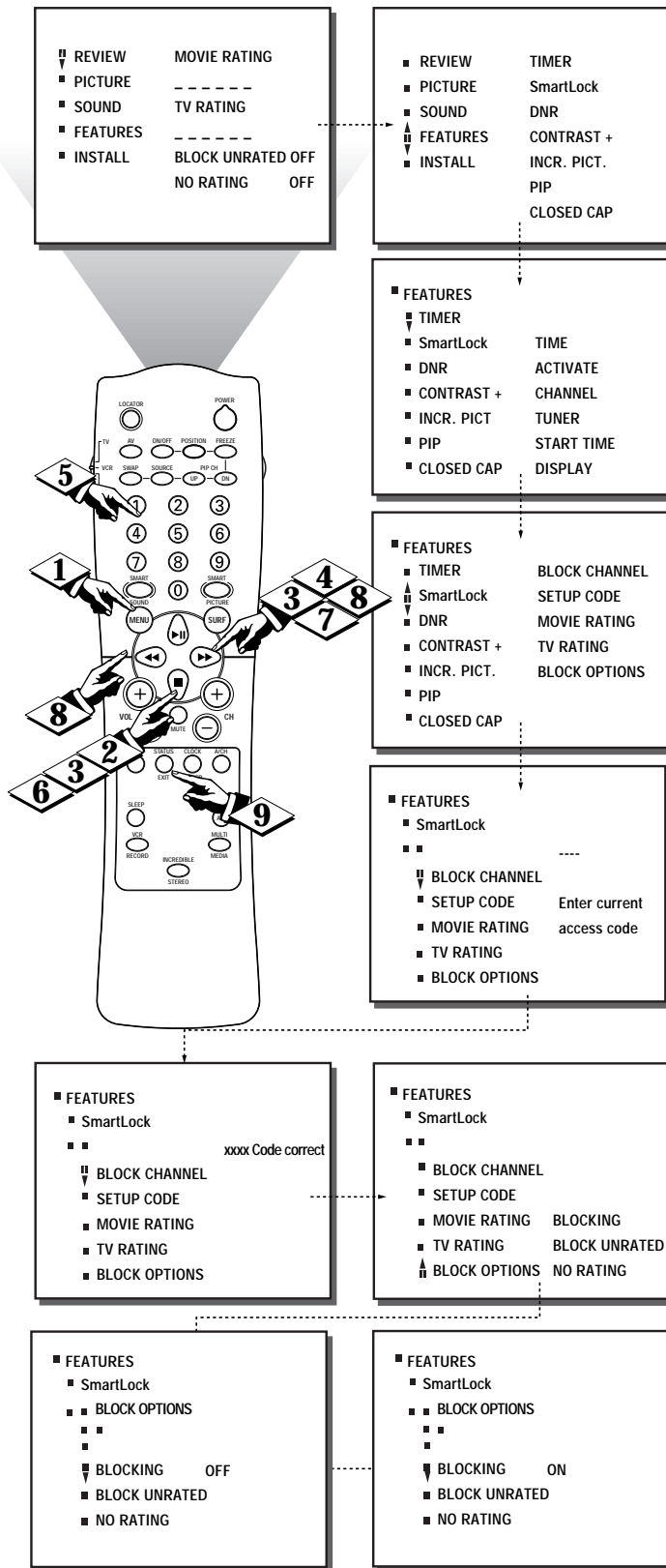

USING SMARTLOCK - BLOCK UNRATED



In addition to blocking specific ratings or channels, you may choose to block all programming that is unrated. (See explanation on page 12.)

BEGIN

- 1 Press the **MENU** button on the remote to show the on-screen menu.
- 2 Press the **CURSOR DOWN** button until the word **FEATURES** is highlighted.
- 3 Press the **CURSOR RIGHT** button to shift the menu to the left, then press the **CURSOR DOWN** button to highlight the **SMARTLOCK** control.
- 4 Press the **CURSOR RIGHT** button again to shift the display left. "---- Enter current access code" will appear within the menu.
- 5 Enter the correct access code number. "XXXX" shows on the screen as you press the **NUMBERED** buttons. "XXXX Code correct" will appear, then **BLOCK CHANNEL** will be highlighted.
- 6 Press the **CURSOR DOWN** button to select **BLOCK OPTIONS**.
- 7 Press the **CURSOR RIGHT** button to shift the menu to the left and see the options. **BLOCKING** will be highlighted.
- 8 Press the **CURSOR DOWN** button to select **BLOCK UNRATED**.
- 9 Press the **CURSOR RIGHT** button or the **CURSOR LEFT** button to set **BLOCK UNRATED** to **ON** or **OFF**.
- 10 Press the **STATUS/EXIT** button to remove the menu.

STOP

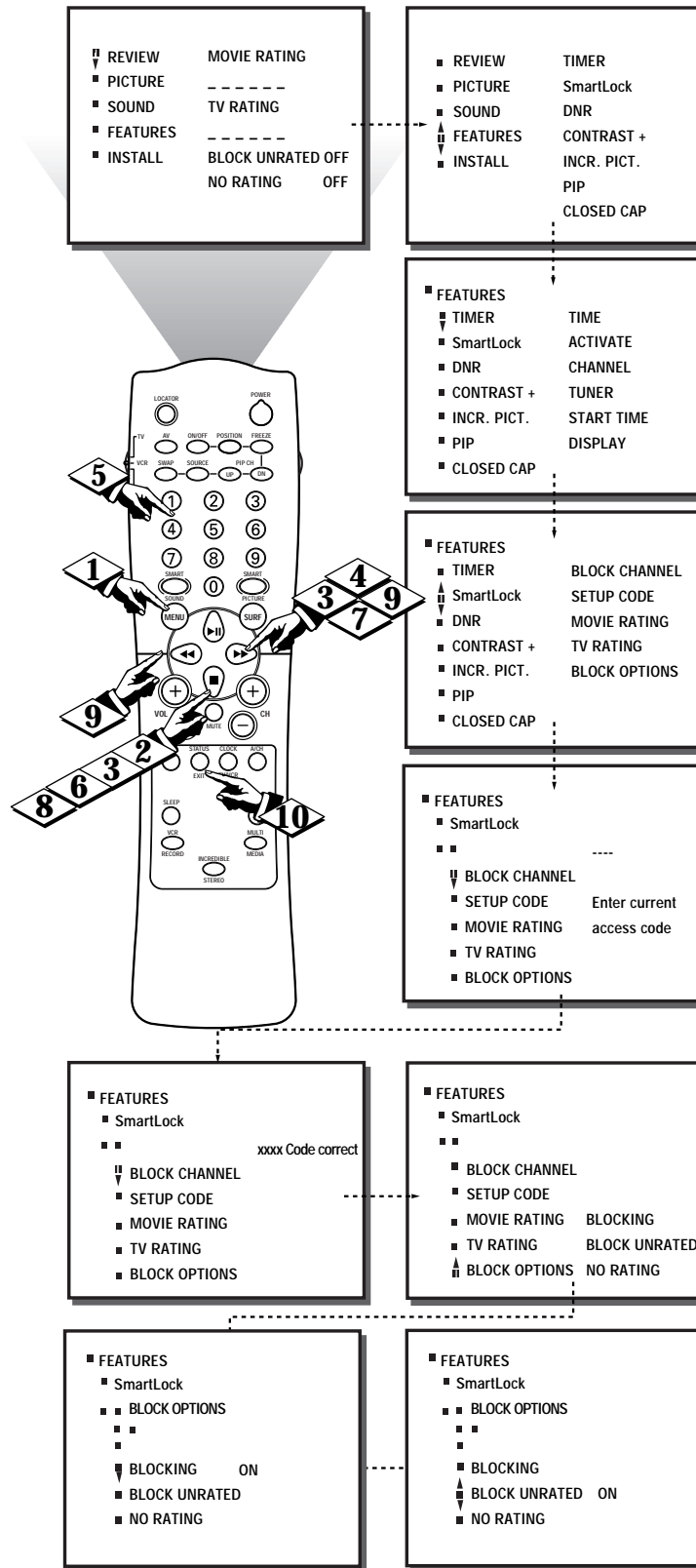

USING SMARTLOCK - NO RATING

Some programming is not encoded with content advisory data by the MPA or the television broadcasters. (See explanation on page 12.) To block such programming, follow these steps.

BEGIN

- 1 Press the **MENU** button on the remote to show the on-screen menu.
- 2 Press the **CURSOR DOWN** button until the word **FEATURES** is highlighted.
- 3 Press the **CURSOR RIGHT** button to shift the menu to the left, then press the **CURSOR DOWN** button to highlight the **SMARTLOCK** control.
- 4 Press the **CURSOR RIGHT** button again to shift the display left. "---- Enter current access code" will appear within the menu.
- 5 Enter the correct access code number. "XXXX" shows on the screen as you press the **NUMBERED** buttons. "XXXX Code correct" will appear, then **BLOCK CHANNEL** will be highlighted.
- 6 Press the **CURSOR DOWN** button to select **BLOCK OPTIONS**.
- 7 Press the **CURSOR RIGHT** button to shift the menu to the left and see the options. **BLOCKING** will be highlighted.
- 8 Press the **CURSOR DOWN** button to select **NO RATING**.
- 9 Press the **CURSOR RIGHT** button or the **CURSOR LEFT** button to set **NO RATING** to **ON** or **OFF**.
- 10 Press the **STATUS/EXIT** button to remove the menu.

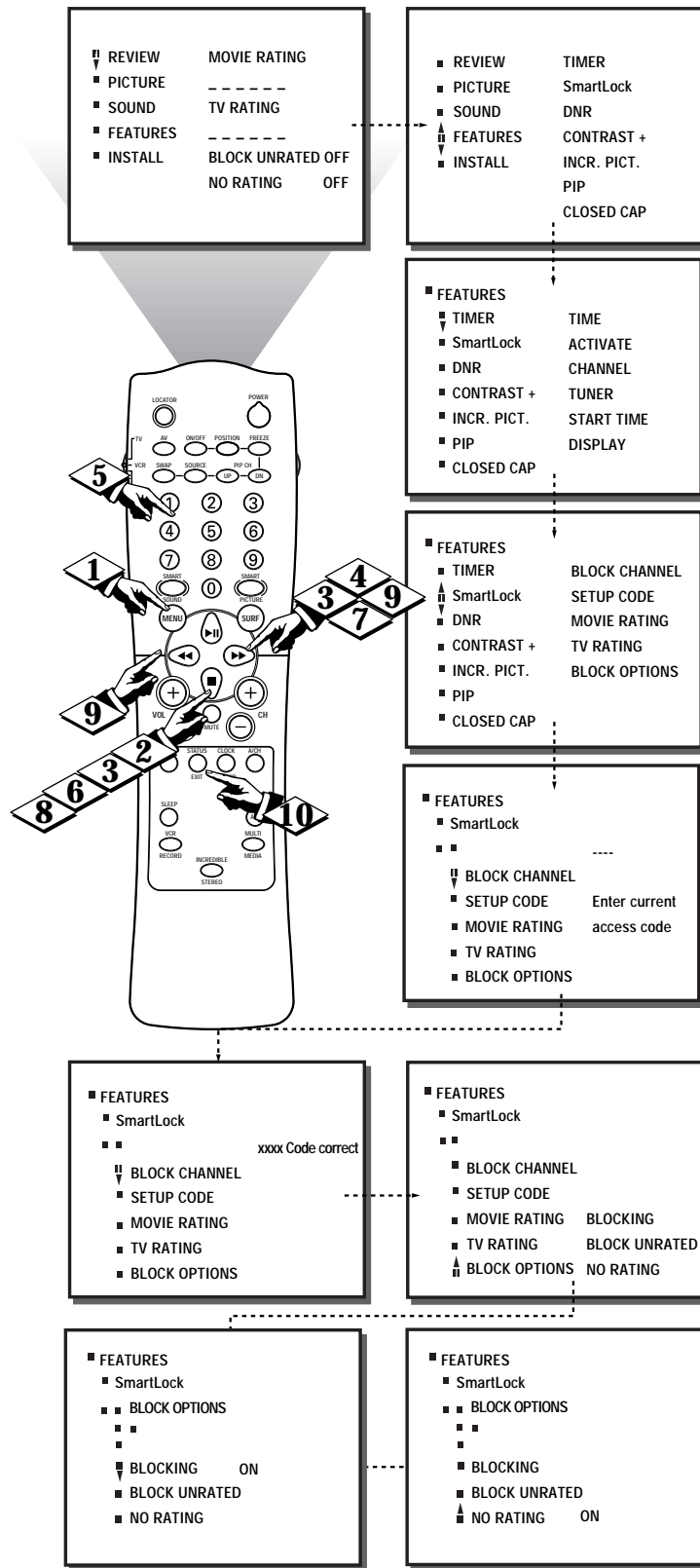

REVIEWING THE SMARTLOCK SETTINGS



A review screen is available to remind you which ratings you have blocked and which Block Options you have selected.

BEGIN

- 1 Press the **MENU** button on the remote to show the on-screen menu. REVIEW should be highlighted.

The ratings that you have blocked will appear on the right side of the menu.

If you have blocked specific sub-ratings, such as V for Violence in the TV-PG category, these blocked sub-ratings will not appear in the review. However, the sub-ratings are still blocked according to your selections.

If a sub-rating (such as V) is blocked but the main category (such as TV-PG) is not, the category will not appear as a blocked rating in the review. However, the sub-rating is still blocked.

- 2 Press the **STATUS/EXIT** button to remove the menu.



SMART HELP



Remember, the **REVIEW** will only appear if **BLOCKING** is set to **ON**. For details, see page 18.

Example: All ratings are blocked and all BLOCK OPTIONS are ON.

▮ REVIEW	MOVIE RATING
▮ PICTURE	G PG PG13 R NC17 X
▮ SOUND	TV RATING
▮ FEATURES	Y Y7 G PG 14 MA
▮ INSTALL	BLOCK UNRATED ON
	NO RATING ON



Example: Some ratings are blocked and some BLOCK OPTIONS are ON.

▮ REVIEW	MOVIE RATING
▮ PICTURE	_ _ _ R NC17 X
▮ SOUND	TV RATING
▮ FEATURES	_ _ _ PG 14 MA
▮ INSTALL	BLOCK UNRATED ON
	NO RATING OFF



Example: **BLOCKING** is set to **OFF**.

▮ REVIEW	SMARTLOCK DISABLED
▮ PICTURE	
▮ SOUND	
▮ FEATURES	
▮ INSTALL	

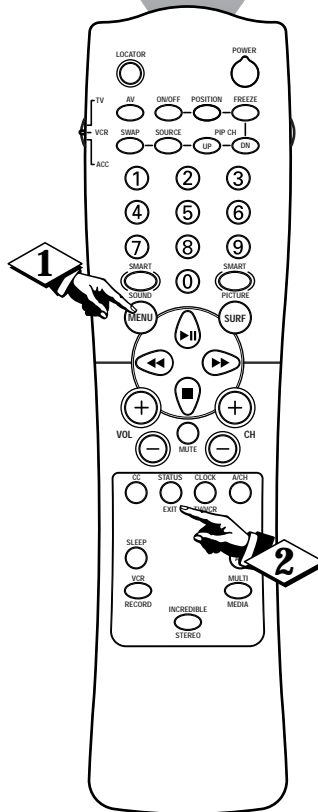

VIEWING BLOCKED PROGRAMMING

Various on-screen messages will appear when someone tries to view blocked programming. Shown here are examples of these messages. The message is determined by how the current programming is blocked. You may view the blocked programming and turn off the SmartLock feature by entering your access code.

BEGIN

- 1 Access a channel directly by pressing the Numbered buttons on the remote control.

If the programming is blocked, a message will appear on the screen, indicating whether the program is blocked because of its rating, the channel, or your selected blocking options.

- 2 Press the Numbered buttons to enter your personal access code.

If you do not know the code, you must press the Channel +/- buttons to select another channel. You can not use the Numbered buttons to select another channel at this time.

- 3 Once you enter the correct personal access code, all blocked channels and programming will be viewable until you turn off the TV power.

When you turn on the TV again, the SmartLock blockings will be restored.

Example: Channel is blocked or rating is blocked.

CHANNEL 22
Blocked by SmartLock

Please enter access code
or select another channel

Example: BLOCK UNRATED is set to ON.

CHANNEL 22
Blocked by TV/MOVIE unrated

Please enter access code
or select another channel

Example: NO RATING is set to ON.

CHANNEL 22
Blocked by TV/MOVIE no rating

Please enter access code
or select another channel

Example: Current programming is blocked and you want to access PIP.

CHANNEL 22
PIP blocked by SmartLock

Please enter access code

CHANNEL 22
Blocked by SmartLock
XXXX

Please enter access code
or select another channel

All channels can be viewed
until TV is turned off.

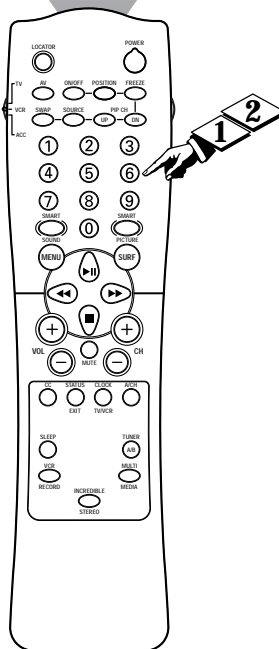

SMART HELP



If SmartLock is activated, you will not be able to access programming in the PIP window until you enter your personal access code.

TURNING ON THE DYNAMIC NOISE REDUCTION (PICTURE) CONTROL

Due to reasons such as poor cable reception, the picture can sometimes appear slightly "speckled" (signal noise in the picture). The DNR (Dynamic Noise Reduction) control can help eliminate this type of interference and improve the quality of the picture.

BEGIN

- 1 Press the **MENU** button on the remote to show the onscreen menu.
- 2 Press the **CURSOR DOWN** button until the word **FEATURES** is highlighted.
- 3 Press the **CURSOR RIGHT** button and the menu will shift to the left, **TIMER** will be highlighted.
- 4 Press the **CURSOR DOWN** button to highlight the **DNR** control.
- 5 Press the **CURSOR RIGHT** button again to highlight the **DNR** option area.
- 6 Press the **CURSOR UP** or **CURSOR DOWN** buttons to turn the DNR feature **ON** or **OFF**.

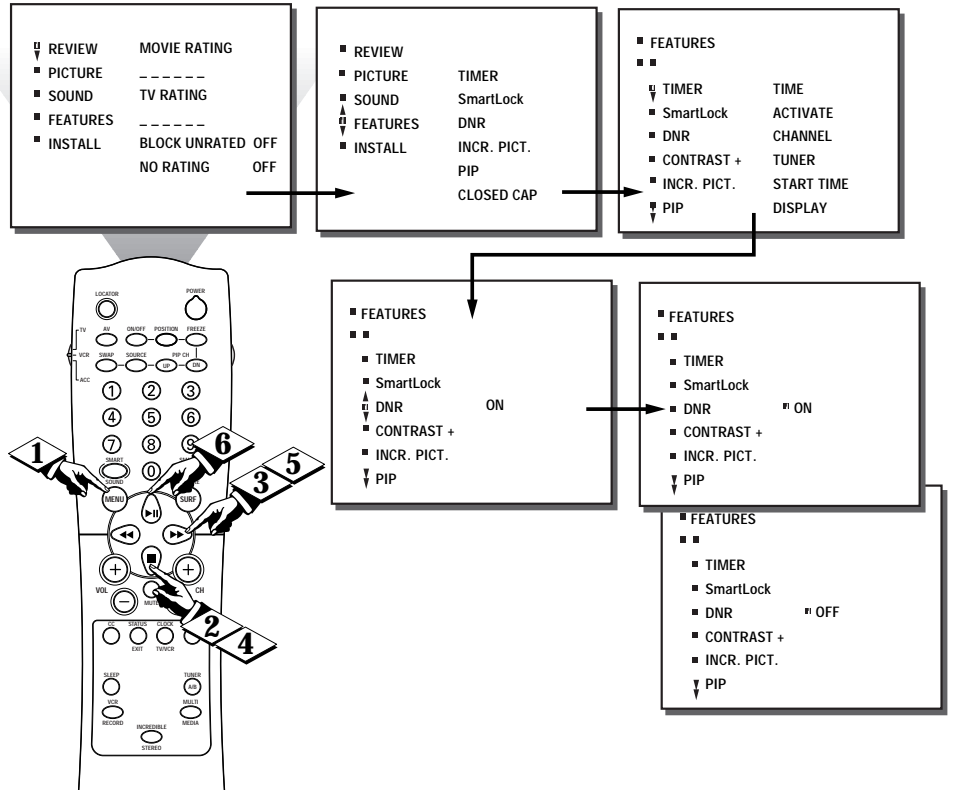

TURNING ON THE CONTRAST + CONTROL

The Contrast + feature helps to "sharpen" the picture quality. The black portions of the picture become richer in darkness and the whites become brighter.

BEGIN

- 1 Press the **MENU** button on the remote to show the onscreen menu.
- 2 Press the **CURSOR DOWN** button until the word **FEATURES** is highlighted.
- 3 Press the **CURSOR RIGHT** button and the menu will shift to the left, **TIMER** will be highlighted.
- 4 Press the **CURSOR DOWN** button to highlight the **CONTRAST +** control.
- 5 Press the **CURSOR RIGHT** button again to highlight the **CONTRAST +** option area.
- 6 Press the **CURSOR UP** or **CURSOR DOWN** buttons to turn the **CONTRAST +** feature **ON** or **OFF**.
- 7 Press the **STATUS/EXIT** button to remove the menu from the screen.

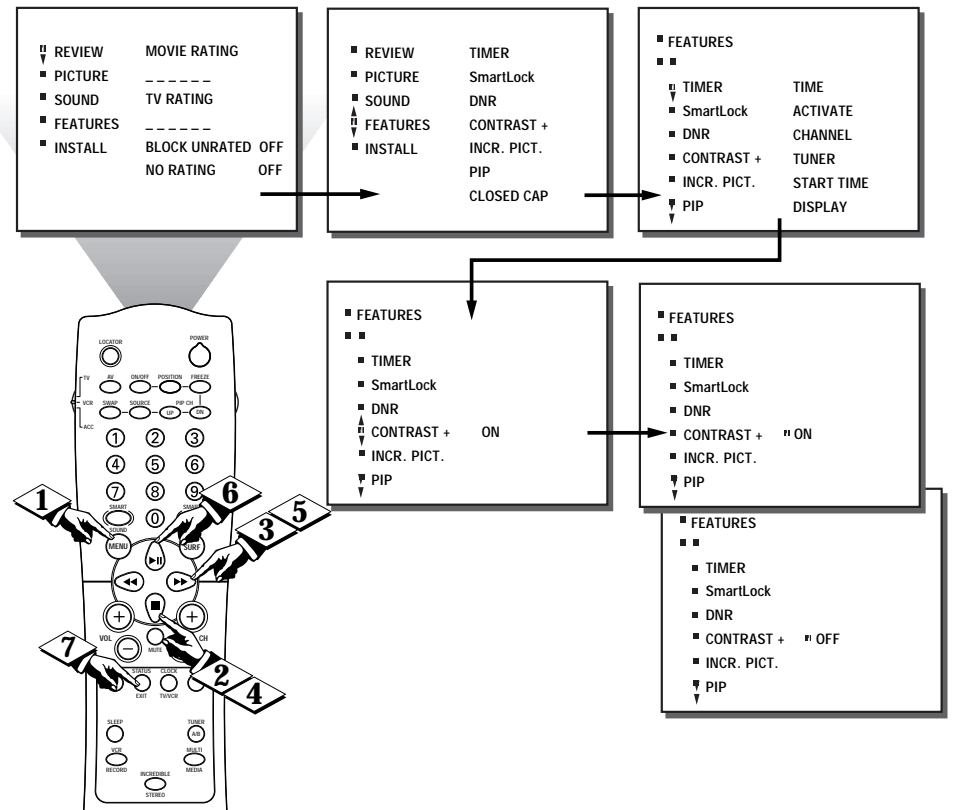

TURNING ON THE INCREDIBLE PICTURE CONTROL

The Incredible Picture feature helps to “sharpen” the picture quality. The black portions of the picture become richer in darkness and the whites become brighter.

BEGIN

- 1 Press the **MENU** button on the remote to show the onscreen menu.
- 2 Press the **CURSOR DOWN** button until the word **FEATURES** is highlighted.
- 3 Press the **CURSOR RIGHT** button and the menu will shift to the left, **TIMER** will be highlighted.
- 4 Press the **CURSOR DOWN** button to highlight the **INCR. PICT.** control.
- 5 Press the **CURSOR RIGHT** button again to highlight the **INCR. PICT.** option area.
- 6 Press the **CURSOR UP** or **CURSOR DOWN** buttons to turn the **INCR. PICT.** feature **ON** or **OFF**.

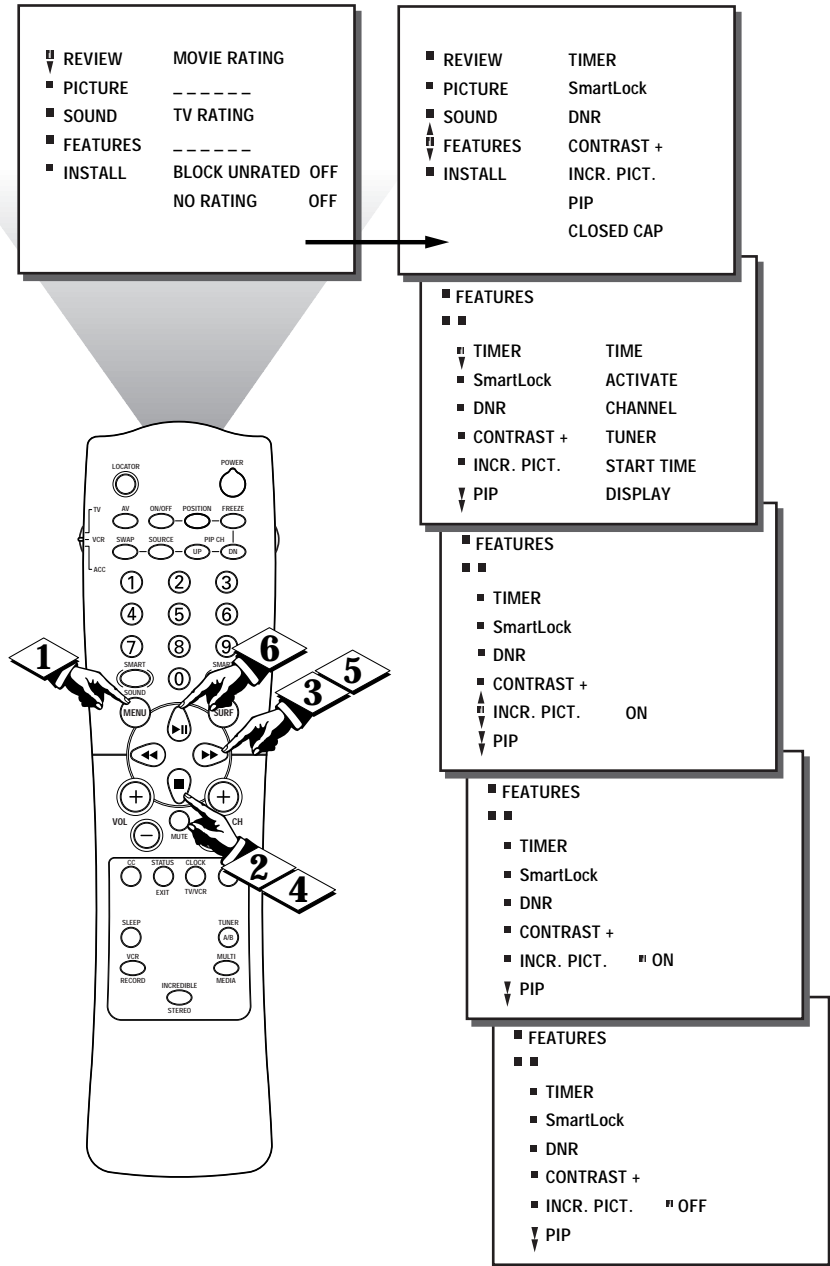

USING THE CLOSED CAPTION CONTROL



Closed Captioning (CC) allows you to read the voice content of television programs on the TV screen. Designed to help the hearing impaired, this feature uses onscreen "text boxes" to show dialogue and conversations while the TV program is in progress.

BEGIN

- 1 Press the **MENU** button on the remote to show the onscreen menu.
- 2 Press the **CURSOR DOWN** button until the word **FEATURES** is highlighted.
- 3 Press the **CURSOR RIGHT** button and the menu will shift to the left, **TIMER** will be highlighted.
- 4 Press the **CURSOR DOWN** button to highlight the **CLOSED CAP** control.
- 5 Press the **CURSOR RIGHT** button again to highlight and choose either **CAPTION MODE** or **TEXT MODE**.
- 6 Press the **CURSOR RIGHT** button again to highlight the **CAPTION MODE** or **TEXT MODE** options area.
- 7 Press the **CURSOR UP** or **CURSOR DOWN** buttons to select the **CLOSED CAPTION** option you want.

CAPTION MODE: CC1, CC2, CC3, CC4, CC MUTE, or OFF - dialogue (and descriptions) for the action on the captioned TV program shows onscreen.

TEXT MODE: TXT1, TXT2, TXT3, TXT4, or OFF - often used for channel guide, schedules, or bulletin board information for CC programs.



NOTE: Not all TV programs and product commercials are made for broadcast with Closed Caption (CC) information included. Neither are all Closed Caption modes (CAPTION 1-4, or TEXT 1-4) necessarily being used by a broadcast station during the transmission of a closed caption program. Refer to your area's TV program listings for the stations and times of Closed Caption shows.

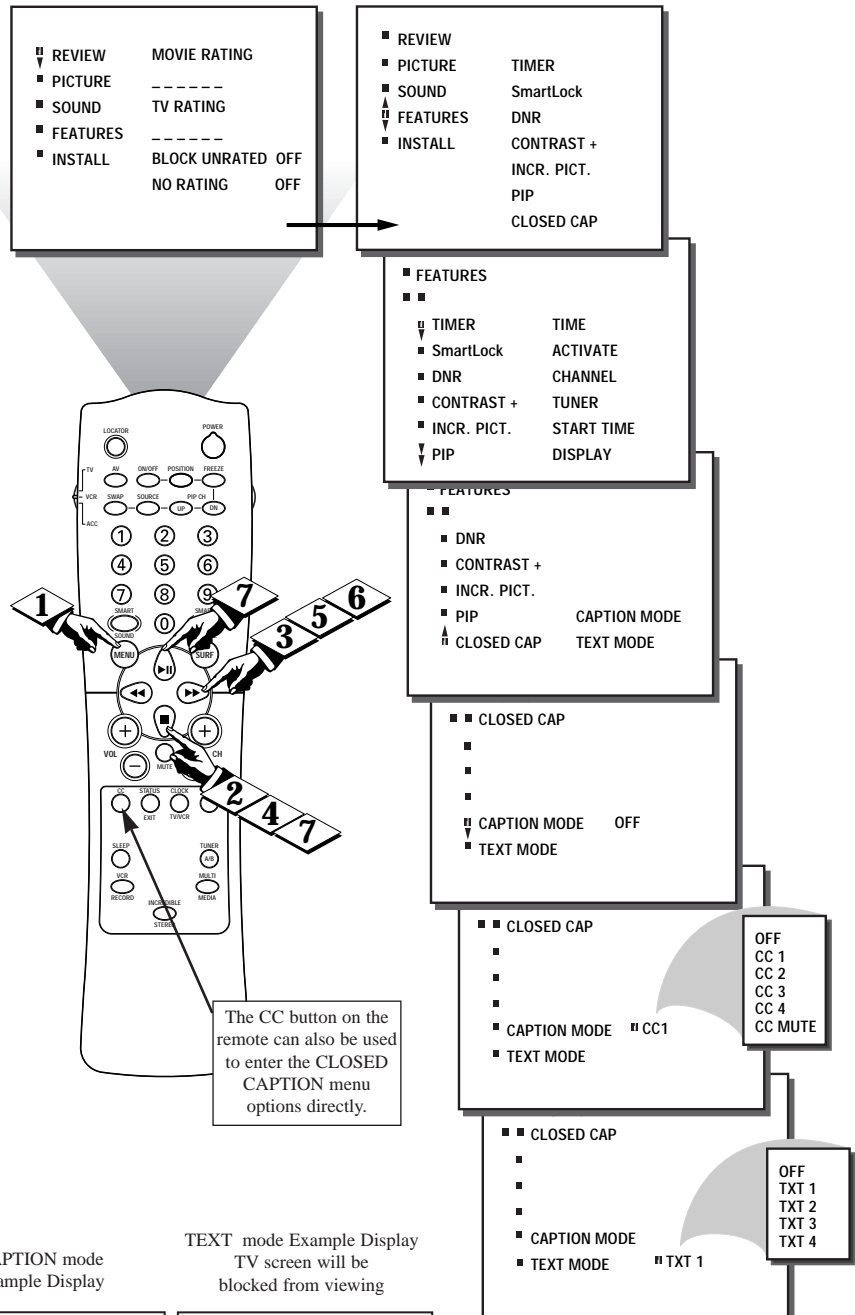

CAPTION mode
Example Display



TEXT mode Example Display
TV screen will be blocked from viewing



NOTE: The CC MUTE option can be used to set the TV to turn the Closed Caption mode "ON" whenever the MUTE button on the remote is pressed.

USING THE SLEEP TIMER CONTROL

Have you ever fallen asleep in front of the TV only to have it wake you up at two in the morning with a test pattern screeching in your ears? Well, your TV can save you all that trouble by automatically turning itself off.

(BEGIN)

1 Press the **SLEEP** button on the remote control and the SLEEP timer onscreen display will appear in the lower center of the screen.

2 Press the **SLEEP** button repeatedly to pick the amount of time (15 minutes to 2 hours ahead) before the TV will turn itself off.

An onscreen count down will appear during the last minute before the TV shuts itself off.

STOP

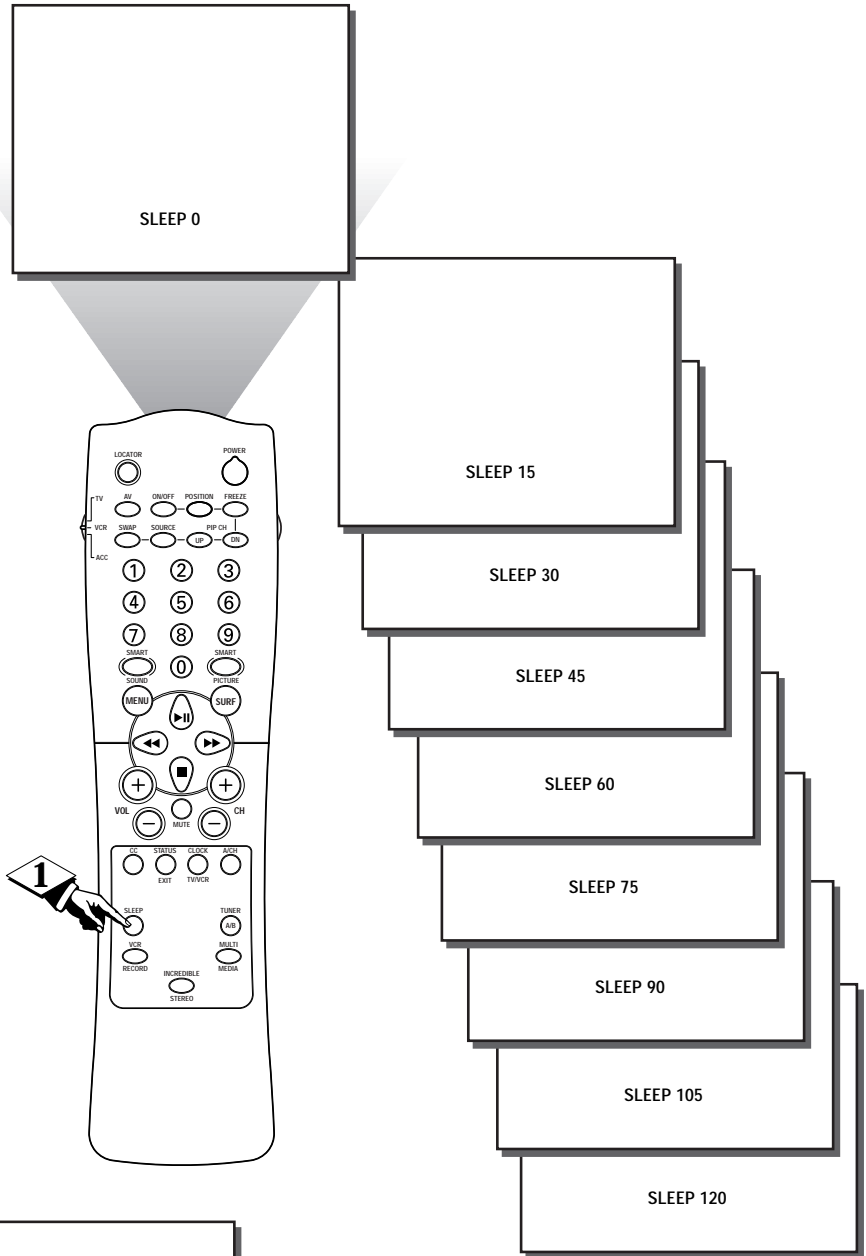

During the last minute of a SLEEP timer setting, an onscreen count down will be displayed.

SLEEP 58

GOOD BYE

During the last 10 seconds of a SLEEP timer setting, an onscreen display will read GOOD BYE.

SLEEP 8

USING TREBLE, BASS, AND BALANCE SOUND CONTROLS

Besides the normal volume level control, your TV also has individual sound adjustment controls. The **TREBLE** (high frequency), **BASS** (low frequency), and **Speaker BALANCE** may all be used to adjust the sound playback of TV programs.

BEGIN

1 Press the **MENU** button on the remote to show the onscreen menu.

2 Press the **CURSOR DOWN** button until the word **SOUND** is highlighted.

3 Press the **CURSOR RIGHT** button and the menu will shift to the right to display an adjustment bar in front of the **TREBLE** control.

4 Use the **CURSOR LEFT** or **RIGHT** buttons to adjust the **TREBLE** (high frequency) level of the television's sound.

5 After adjusting the **TREBLE** control, press the **CURSOR DOWN** button to select another Sound adjustment; **BASS** or **BALANCE**. Use the **CURSOR LEFT** or **RIGHT** buttons to adjust the selected control.



SMART HELP

Remember, when the bar scale is centered, **Speaker BALANCE** is centered between the TV's Left and Right side speakers.

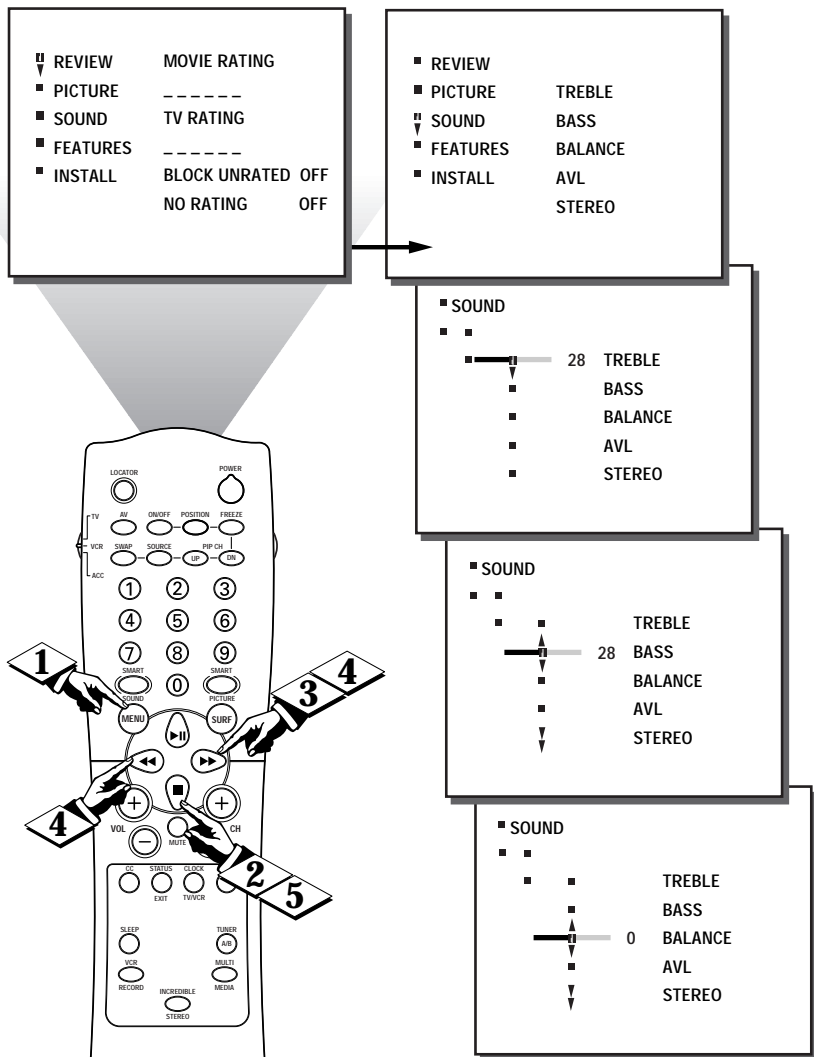

HOW TO SET THE TV FOR STEREO PROGRAMS

Your TV can receive broadcast stereo TV programs. The TV has both an amplifier and twin speakers through which the stereo sound can be heard.

BEGIN

- 1 Press the **MENU** button on the remote to show the onscreen menu. **PICTURE** will be highlighted.
- 2 Press the **CURSOR DOWN** button to select the **SOUND** menu.
- 3 Press the **CURSOR RIGHT** button and the menu will shift to the right to display an adjustment bar in front of the **TREBLE** control.
- 4 Press the **CURSOR DOWN** button to select the **STEREO** control.
- 5 Use the **CURSOR LEFT** or **RIGHT** buttons to select **STEREO** or **MONO**. With **STEREO** selected the television will reproduce any stereo broadcast signal it receives.

STOP

SECOND AUDIO PROGRAM (SAP)

SAP is an additional part of the stereo broadcast system. Sent as a third audio channel SAP can be heard apart from the current TV program sound. TV stations are free to use SAP for any number of purposes, but many experts believe it will be used for foreign language translations of TV shows (or for weather and news bulletins.)

If a SAP signal is not present with a selected program, the SAP option cannot be selected. Also, if SAP is selected on a channel (with SAP) and you select another channel, when you return to the original channel SAP will be OFF (and you will have to reselect the SAP feature.)

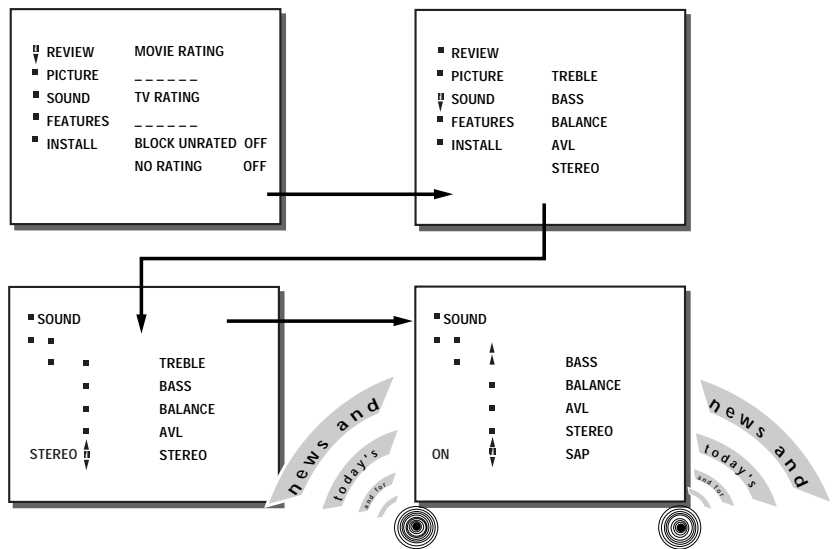
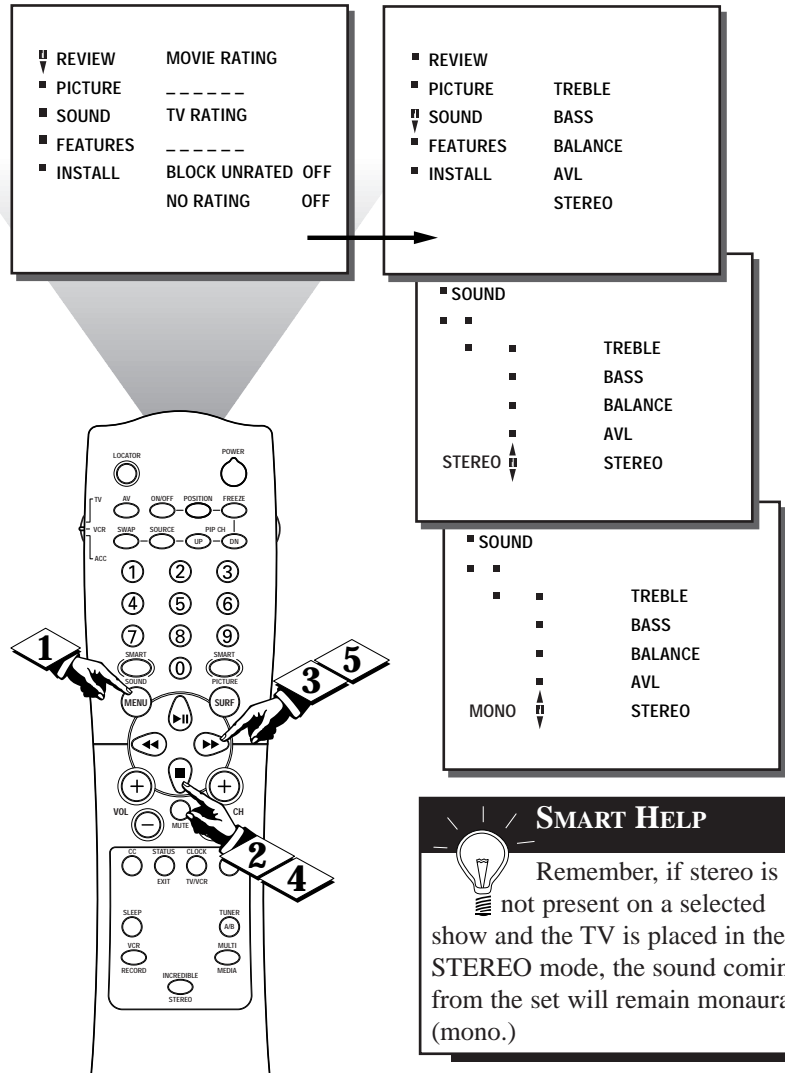

USING THE INCREDIBLE STEREO FEATURE



The Incredible Stereo feature adds greater depth and dimension to both monaural (MONO) and stereo TV sound. With the control turned ON the TV's speakers can add even wider sound separation to normal broadcasts.

BEGIN

- 1 Press the **MENU** button on the remote to show the onscreen menu.
- 2 Press the **CURSOR DOWN** button until the word **SOUND** is highlighted.
- 3 Press the **CURSOR RIGHT** button and the menu will shift to the right to display an adjustment bar in front of the **TREBLE** control.
- 4 Press the **CURSOR DOWN** button to select the **INCR. STEREO** control.
- 5 Use the **CURSOR UP** or **DOWN** buttons to turn this feature ON.

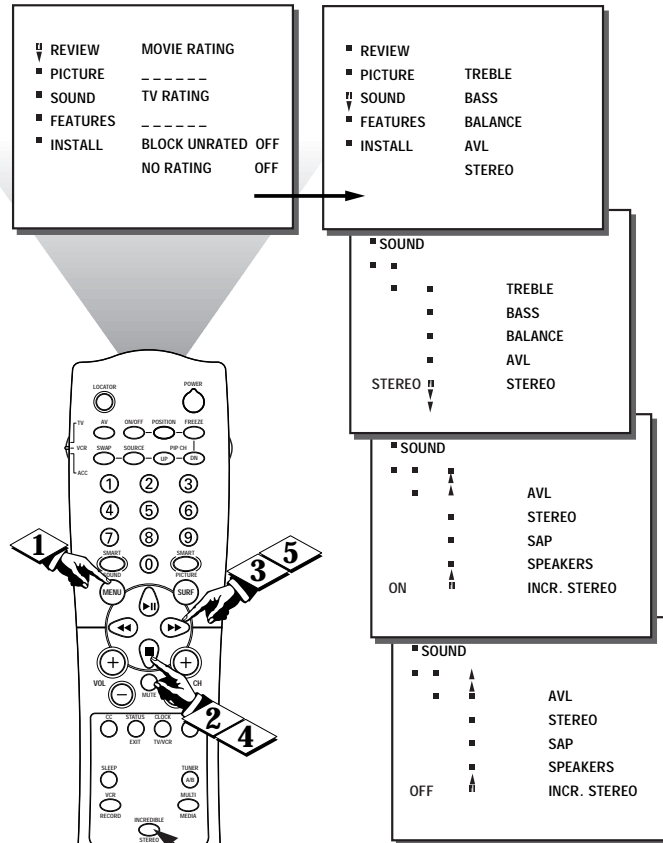

When the TV signal is MONO, SPATIAL will appear onscreen when the INCREDIBLE STEREO button is pressed. When the signal is STEREO, INCR. STEREO will appear onscreen when the INCREDIBLE STEREO button is pressed.

USING THE TV VOLUME BAR CONTROL

Use the Volume Bar control to see the TV's volume level setting on the TV screen. The Volume Bar will be seen each time the VOLUME buttons (on the TV or remote) are pressed.

BEGIN

- 1 Press the **VOLUME (+) or (-)** buttons on the remote to show the **VOLUME** bar display onscreen.
- Press the **VOLUME (+) or (-)** buttons again to adjust the television's sound level.

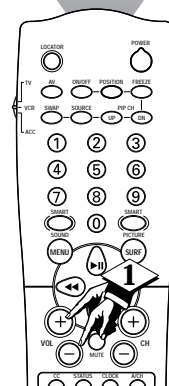
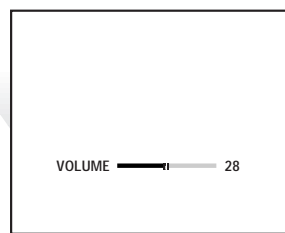

SMART HELP



Try it out.
Press the **VOL (+)** and **(-)** buttons. The **VOLUME BAR** should appear near the bottom center of the screen.

USING THE TV SPEAKER CONTROL AND AUDIO OUTPUT JACKS

Would you like to hear TV programs through your audio hi-fi system? The TV's Audio Output jacks and TV Speaker On/Off control work together to offer you this TV sound option.

BEGIN

- 1 **Connect the R(right) and L(left) AUDIO OUT** jacks on the TV to the R and L Audio Input jacks on your amplifier or sound system. Set the audio system's volume to normal listening level.
- 2 **Turn the TV and audio system ON.** You can now adjust the sound level coming from the audio system with the VOLUME (+) or (-) buttons on the TV or remote.
- 3 To hear the TV sound from only the audio system speakers. **Press the MENU** button on the remote to show the onscreen menu.
- 4 **Press the CURSOR DOWN** button until the word **SOUND** is highlighted.
- 5 **Press the CURSOR RIGHT** button and the menu will shift to the right to display an adjustment bar in front of the **TREBLE** control.
- 6 **Press the CURSOR DOWN** button to select the **SPEAKER** control.
- 7 **Use the CURSOR RIGHT** or **CURSOR LEFT** buttons to select turn the television's speakers **OFF**. You should now only hear TV sound coming from the audio system speakers.



SMART HELP



Remember, the audio system may have to be in AUX(iliary) mode to play sound from the TV.

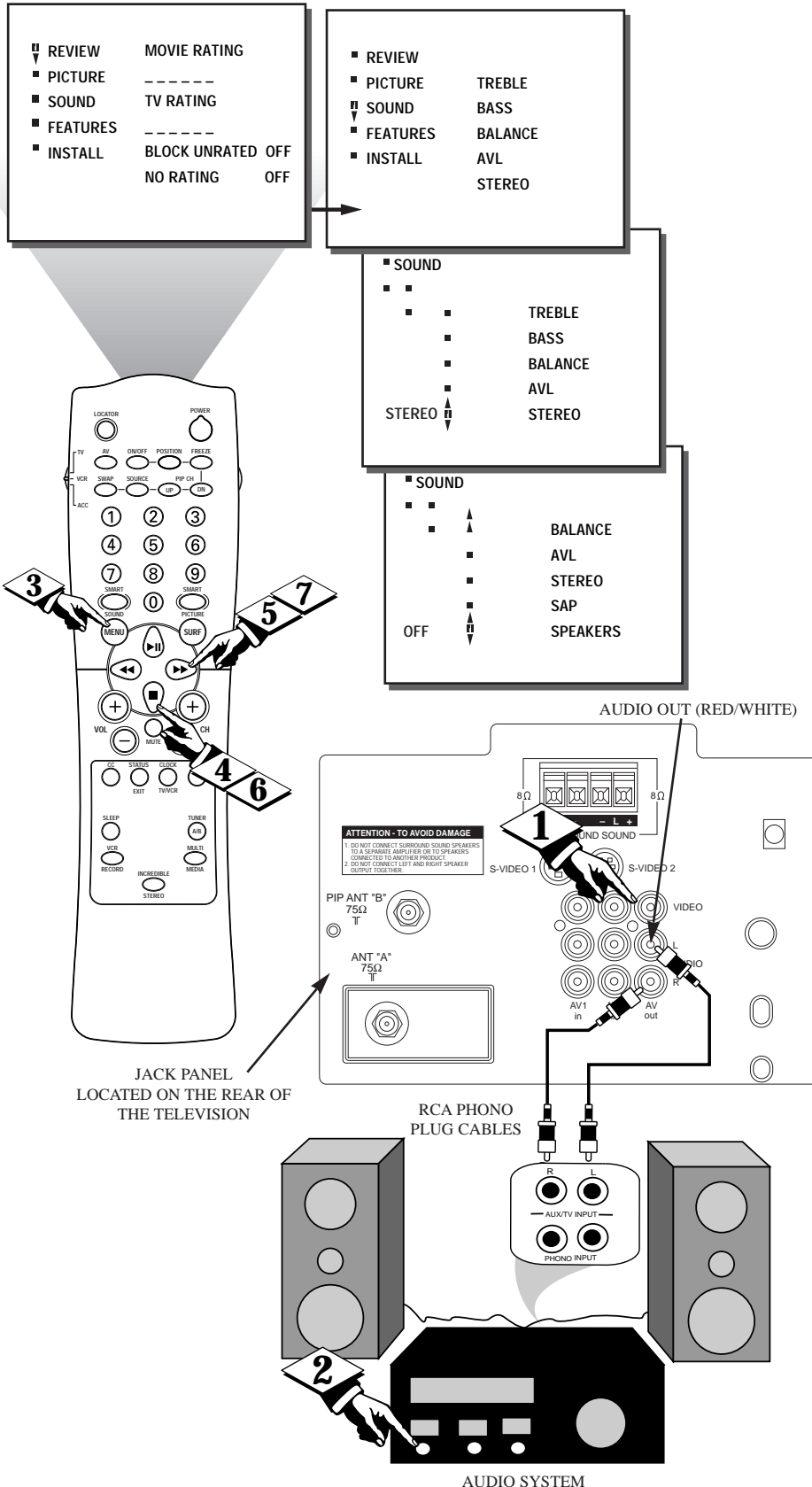

USING THE SURROUND SOUND EXTERNAL SPEAKER CONNECTIONS



By adding optional external speakers to the TV's sound system, you can create the feeling of reflected sound that surrounds you at a movie theater or concert hall.

BEGIN

- 1 Connect both external speakers to the speaker wire terminals on the TV.

Recommended speakers: 8 ohm, 15 watt minimum. Be sure the (+) and (-) speaker wires are connected to the correct R(ight) and L(ef) speaker terminals on the TV.

- 2 Place the speakers so the viewing area is between the TV and the rear surround speakers. (See overhead view drawing.)

- 3 Turn the TV and the STEREO control ON.

After setup whenever a stereo signal is received the audio will be heard in Surround Sound.



SMART HELP



Remember, Surround Sound will not work with only one speaker connected; or with monaural audio material (unless the Incredible Stereo feature is turned ON).

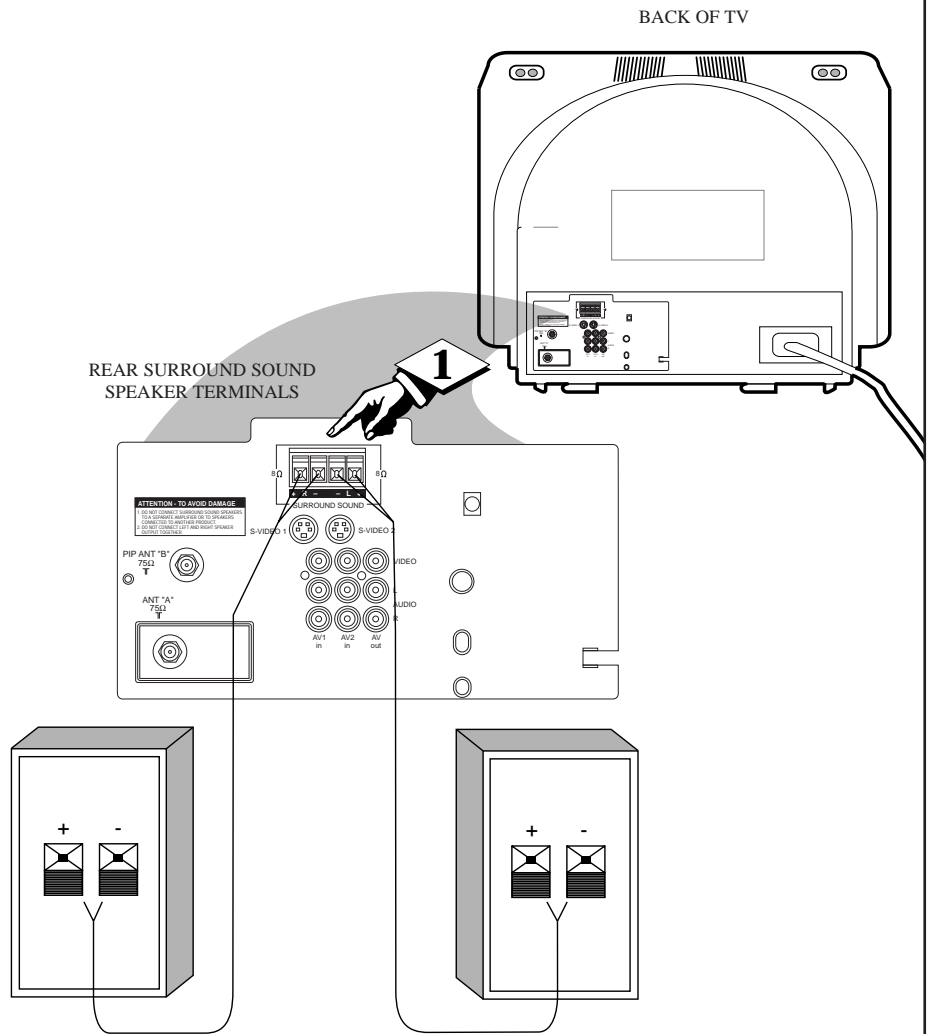

REAR SURROUND SOUND SPEAKERS

Note: The rear Surround Sound speakers will not be heard at the same volume level as the front TV speakers. It is intended for the rear speakers to give a background noise effect which requires a lower volume level than the TV's front speakers.

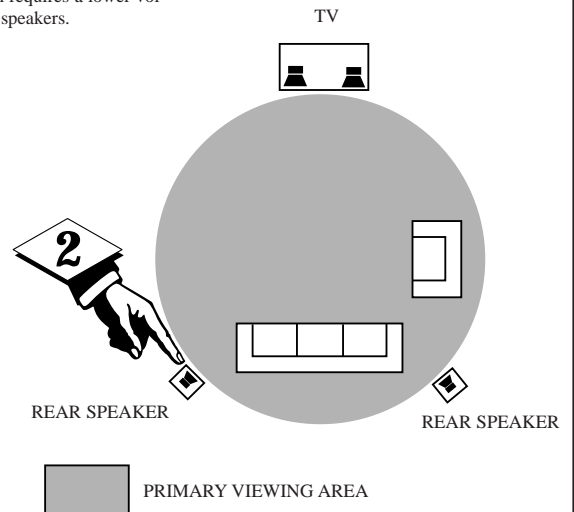

HOW TO USE THE AUDIO/VIDEO INPUT JACKS

AUDIO/VIDEO INPUTS

The TV's Audio/Video Input jacks are for direct picture and sound connections between the TV and a VCR (or similar device) that has Audio/Video Output jacks.

BEGIN

- 1 Connect the **VIDEO (yellow) CABLE** to the VIDEO IN jack on the back of the TV. Then connect the **AUDIO (red and white) CABLES** to the AUDIO (left and right) IN jacks on the rear of the TV (AV 1 or AV 2).
- 2 Connect the **VIDEO (yellow) CABLE** to the VIDEO OUT jack on the back of the VCR. Then connect the **AUDIO (red and white) CABLES** to the AUDIO (left and right) OUT jacks on the rear of the VCR.
- 3 Turn the **VCR and the TV ON**.
- 4 Use the **A/V button** on the remote to select the AV 1 channel.

With the VCR ON and a pre-recorded tape inserted, **press the PLAY button** to view the tape on the television.



SMART HELP

An additional accessory device can be hookup by repeating the steps above using the AV 2 input jacks.

NOTE: Repeatedly pressing the AV button on the remote will toggle the picture source from the current channel, to the last channel viewed, then to the AV 1 connection, then to the AV 2 connection. This also applies to the Multi Media button on the remote. Repeatedly pressing the Multi Media button will toggle the picture source from the current channel to the last viewed channel, then to the MM 1 (AV 1) connection, then to the MM 2 (AV 2) connection.

When using the Audio/Video AV 1 input jacks, the video and sound can be viewed and heard on the AV 1 channel.

When using the Audio/Video AV 2 input jacks, the video and sound can be viewed and heard on the AV 2 channel.

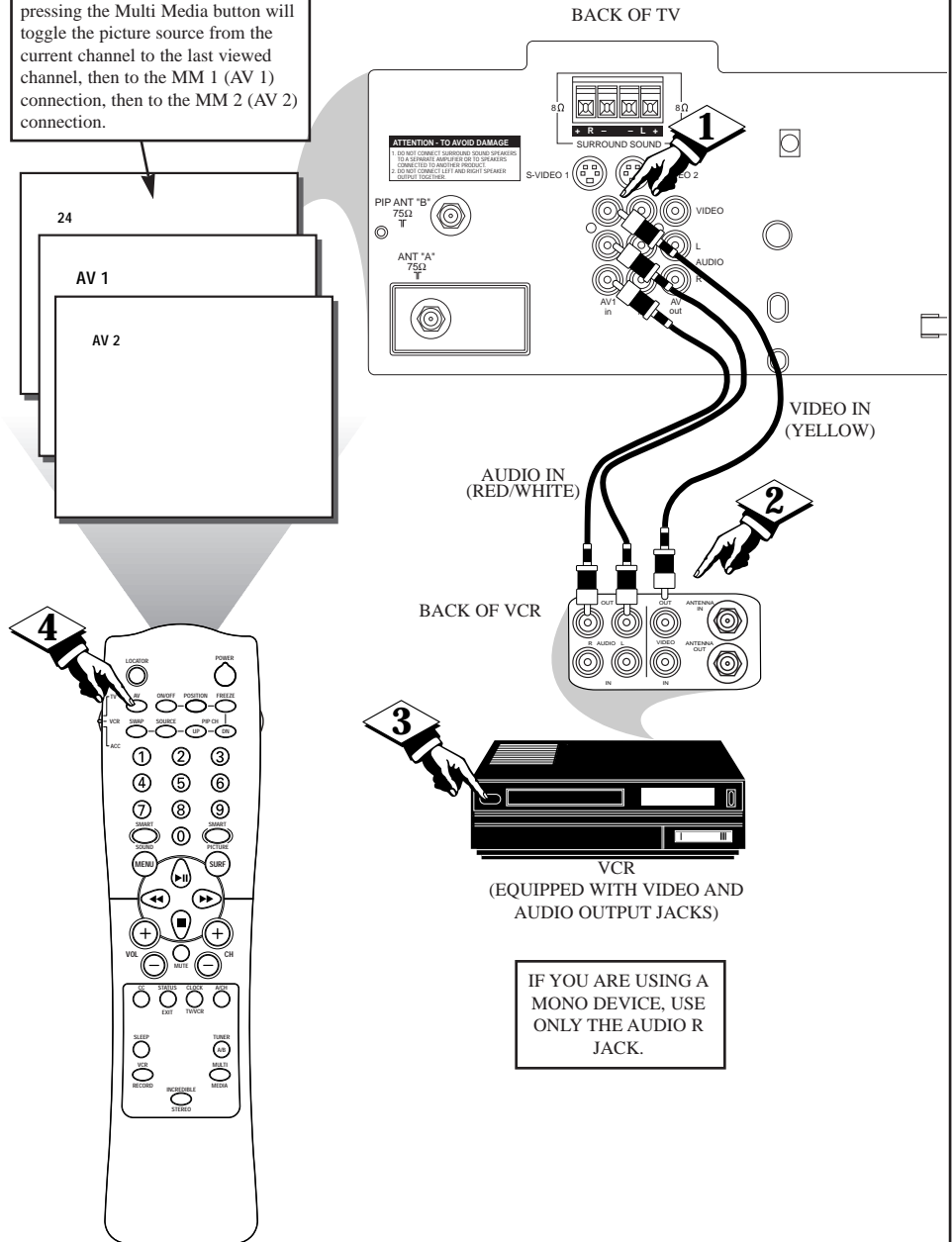

HOW TO USE THE AUDIO/VIDEO INPUT JACKS

S-VIDEO INPUT

The S(uper)-Video connection on the rear of the television can give you better picture detail and clarity, for the playback of S-VHS VCR tapes, or Digital Video Discs than the normal antenna picture connections.

Note: The accessory device being used must have a S-Video Output to complete this connection.. The following steps show the connections to the S-VIDEO 1 and AV 1 input jacks. To hookup an additional device to S-VIDEO 2 and AV 2 input jacks, repeat the procedure.

BEGIN

- 1 **Connect the S-VIDEO CABLE** to the S-VIDEO 1 input jack on the rear of the television, then the AUDIO (red and white) to the AUDIO IN (AV 1) jacks on the rear of the TV.
- 2 **Connect the S-VIDEO CABLE** to the S-VIDEO output jack on the accessory device. Then connect the red and white AUDIO CABLES to the AUDIO (left and right) output jacks on the rear of the accessory device.
- 3 **Turn the VCR (or Digital Video Disc Player) ON.**
- 4 **Press the AV button** on the remote to tune to the SVID-R channel. You are now ready to view the tape or disc on the TV.

STOP

NOTE: Repeatedly pressing the AV button on the remote will toggle the picture source from the current channel, to the last channel viewed, then to the AV 1 connection, then to the AV 2 connection. This also applies to the Multi Media button on the remote. Repeatedly pressing the Multi Media button will toggle the picture source from the current channel to the last viewed channel, then to the MM 1 (AV 1) connection, then to the MM 2 (AV 2) connection.

When using the S-VIDEO 1 and AV 1 Audio input jacks, the video and sound can be viewed and heard on the AV 1 channel.

When using the S-VIDEO 2 and AV 2 Audio input jacks, the video and sound can be viewed and heard on the AV 2 channel.

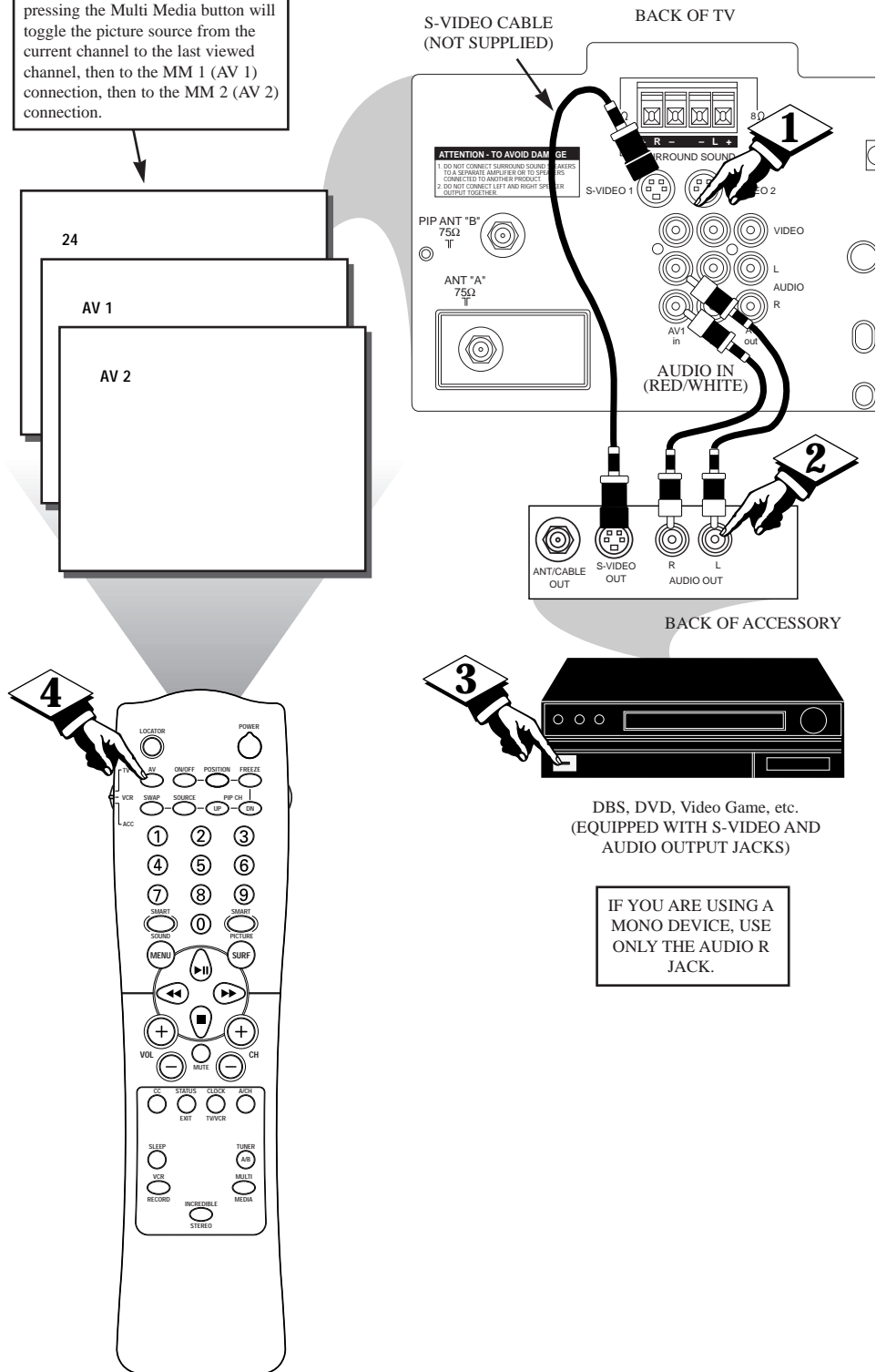



USING THE REMOTE LOCATOR FEATURE

Have you ever played hide and seek with your remote control? Are you tired of tearing the house apart trying to find if someone has stuffed the remote under the couch, put it on the shelves, or hid it in the desk? Well, your TV remote can save you all that looking by automatically signaling its location to you.

Here's how it works:

BEGIN

- 1** Press the **POWER** button on the set to turn the TV ON.

Note: Normally you can press any button on the front of the TV to turn the set ON. But for the remote locator to work you need to be sure to use the Power button at the TV.

A "locating remote" message shows on the TV screen.

- 2** Within a few seconds a **chirping or beeping** sound will begin to come from the remote control hand unit.

The remote will continue to signal its location for around 30 seconds. Normal TV program sound will not be heard while the remote locator is working.

- 3** Once you find the remote just press any button on the remote and the beeping will stop.

The remote is now ready for normal TV feature use.



SMART HELP



Remember, the remote locator may not properly receive its "homing" signal from the TV if it has been placed on a metal shelf or counter material.

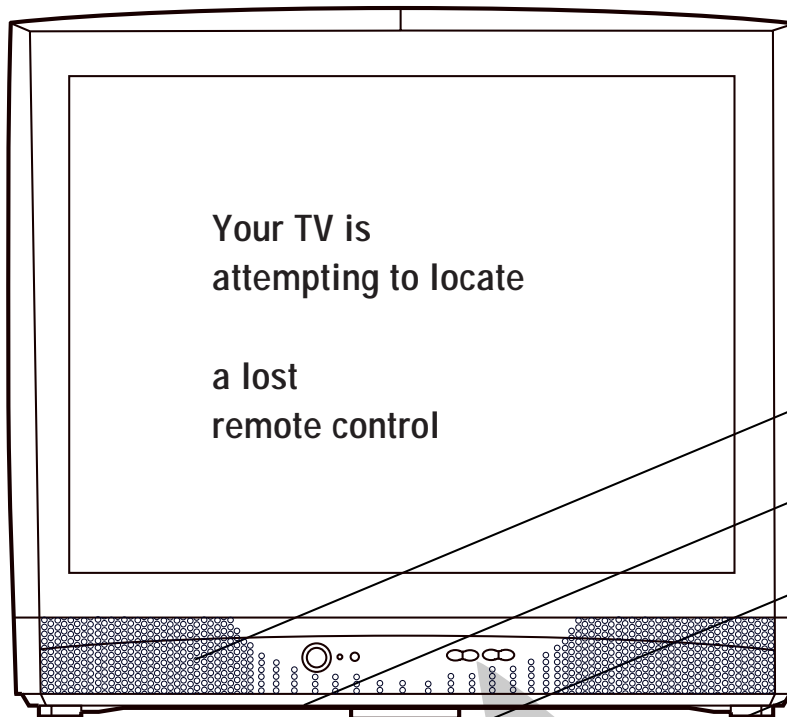

REMOTE LOCATOR "HOMING"
RANGE IS AROUND 30 FEET.



USING THE REMOTE LOCATOR FEATURE

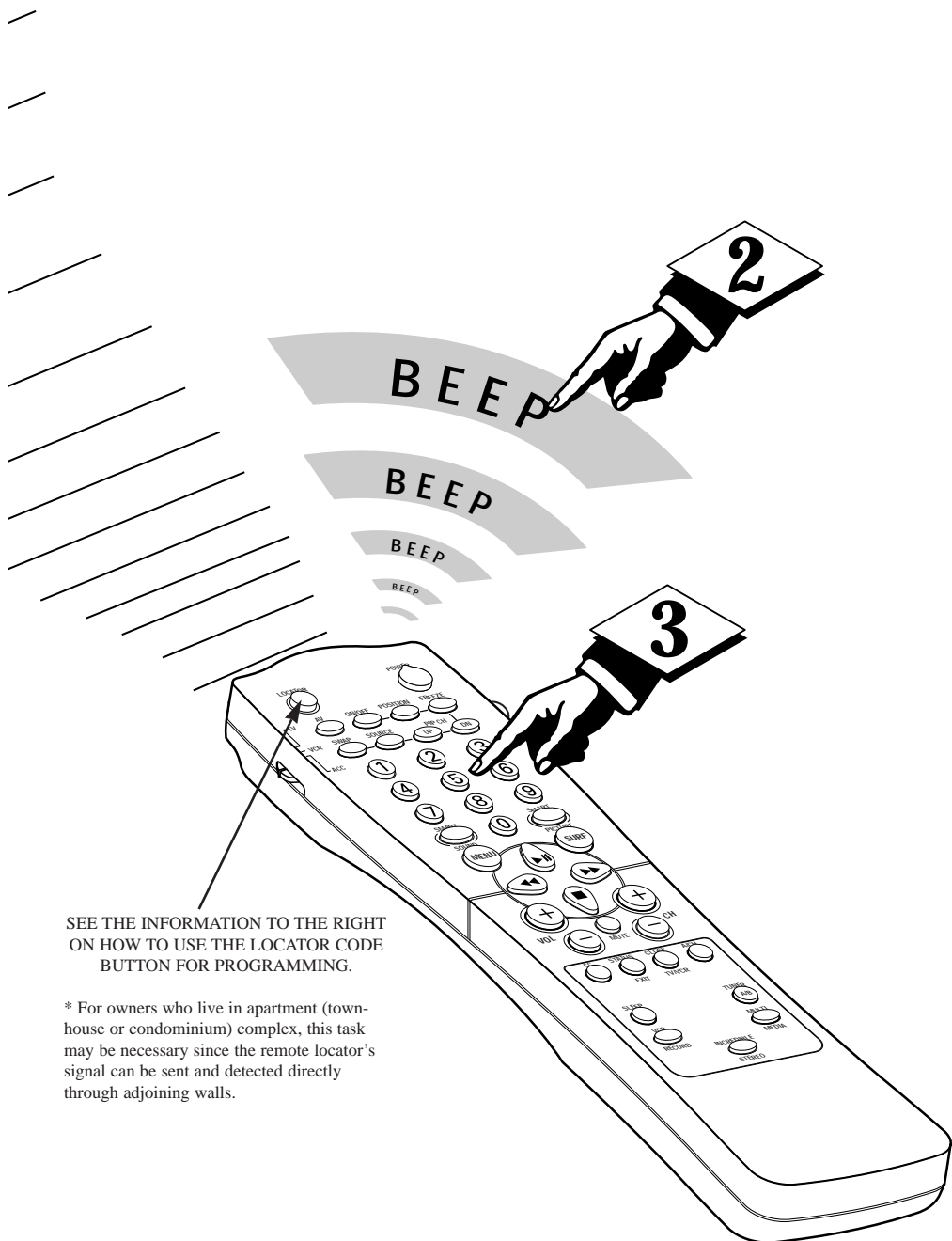

SEE THE INFORMATION TO THE RIGHT ON HOW TO USE THE LOCATOR CODE BUTTON FOR PROGRAMMING.

* For owners who live in apartment (town-house or condominium) complex, this task may be necessary since the remote locator's signal can be sent and detected directly through adjoining walls.

ADDRESS CODE PROGRAMMING OF THE REMOTE

For most homes this step would not be needed but for your information:

Up to 9 different remote locator address codes can be set on which the TV can send out its "homing" signal.

This is done in case there is more than one TV (with remote locator) present, and you want only one specific remote to be signaled when the TV is turned ON.*

To set a Locator Address Code:

BEGIN

1 With the TV turned ON, press the **LOCATOR CODE** button on the remote. (Also be sure the TV/VCR/ACC SYSTEM switch is in the TV mode.)

2 The TV shows the present Remote Locator Code.

Remote Locator Code is set to 5

Press any number key to change code

3 Press any number button (0-9) on the remote to set or change the Locator Code.

Remote Locator Code has been changed

new code is 2



SMART HELP

Remember, if the batteries are replaced the Locator Code will need to be reentered.

When setting the Locator Code if any button, other than the number buttons are pressed, the remote will return to its normal operation mode.



USING THE SMARTPICTURE CONTROL

Whether you're watching a movie or a video game, your TV has automatic video control settings matched for your current program source or content. The SmartPicture feature quickly resets your TV's video controls for a number of different types of programs and viewing conditions you may have in your home. Each SmartPicture setting is preset at the factory to automatically adjust the TV's Brightness, Color, Picture, Sharpness, Tint, and Color Temperature levels.

BEGIN

1 Press the **SMART PICTURE** button on the remote control. The current SmartPicture setting will appear in the middle of the screen.

2 Press the **SmartPicture** button repeatedly to select either **PERSONAL**, **MOVIES**, **SPORTS**, **WEAK SIGNAL**, or **MULTI MEDIA** picture settings.

Note: The **PERSONAL** setting is the setting that you setup using the **PICTURE** options within the onscreen menu. This is the only setting that can be changed. All other settings are setup at the factory during the time of production.

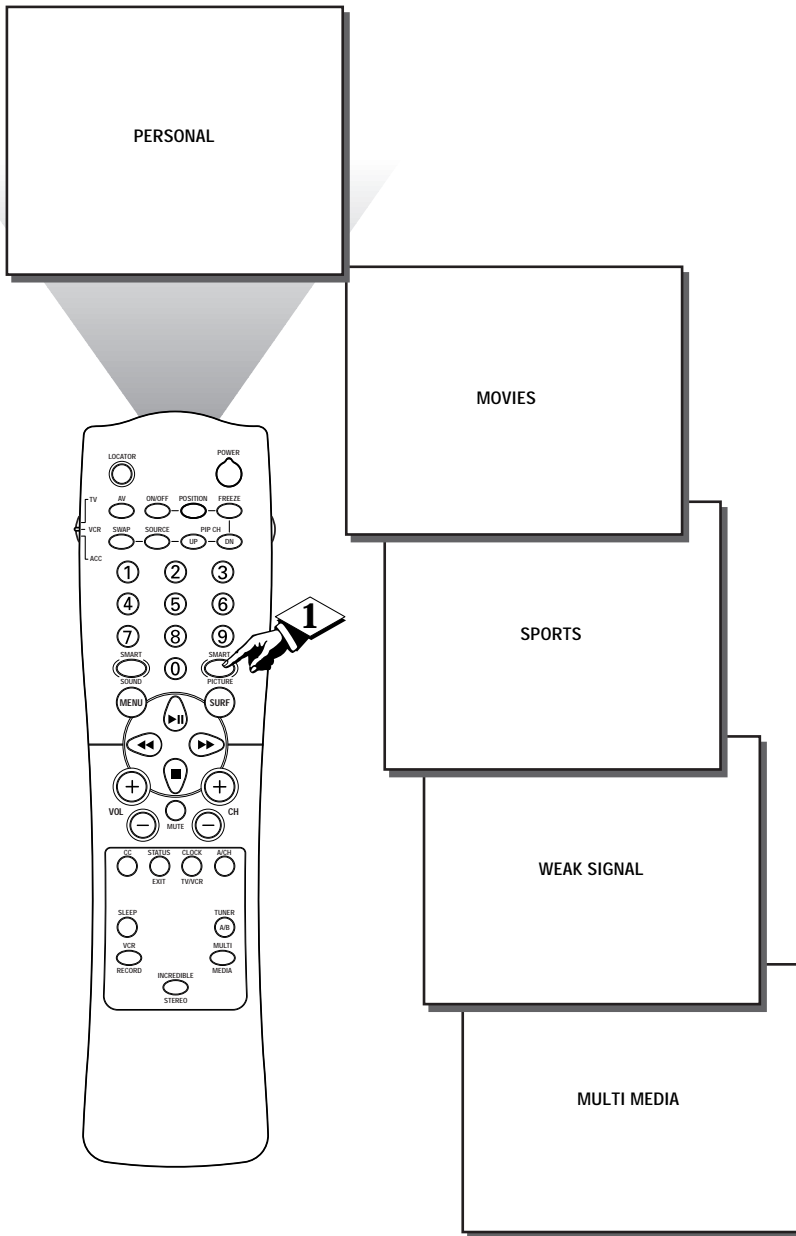

USING THE SMARTSOUND CONTROL



The SmartSound feature allows the listener to select between four different factory-set sound options. Personal (which can be set by the user), Theater (for movie viewing), Music (for musical programming) and Voice (when the program is mainly dialogue). To select any of the options, follow the directions below.

BEGIN

1 Press the SMART SOUND button on the remote control. The current SmartSound setting will appear in the middle of the screen.

2 Press the SMART SOUND button repeatedly to toggle between the four settings, PERSONAL, VOICE, MUSIC or THEATRE.

Remember, only the PERSONAL control can be changed by the viewer. This changes the settings in the main on-screen menu's sound controls.

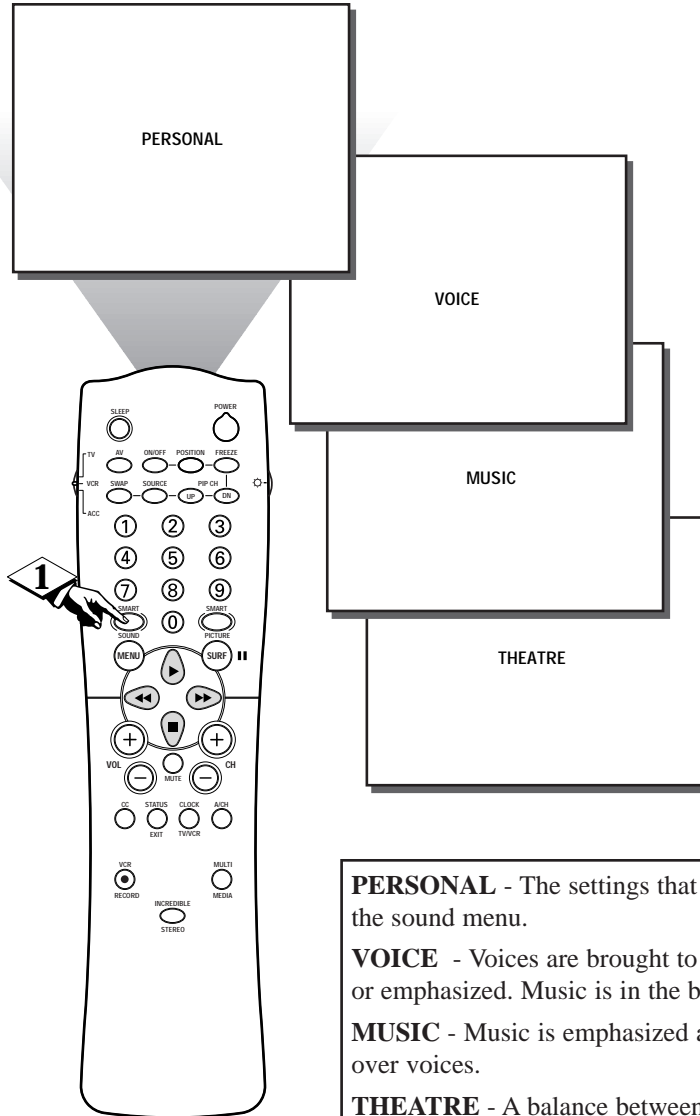

PERSONAL - The settings that you make in the sound menu.

VOICE - Voices are brought to the forefront or emphasized. Music is in the background.

MUSIC - Music is emphasized and dominant over voices.

THEATRE - A balance between voices and music.

SMART HELP



Remember, SmartSound works only with the programs coming through the ANTENNA/CABLE (ANT A) input on the rear of the TV (RF audio). It will not control the sound levels for the External connections.

AVL CONTROL

In most cases, the volume levels coming from broadcast programming or commercials are never the same. With the AVL (Audio Volume Leveler) control turned ON, you can have the TV level out the sound being heard. This makes for a more consistent sound by reducing the peaks and valleys that occur during program changes or commercial breaks.

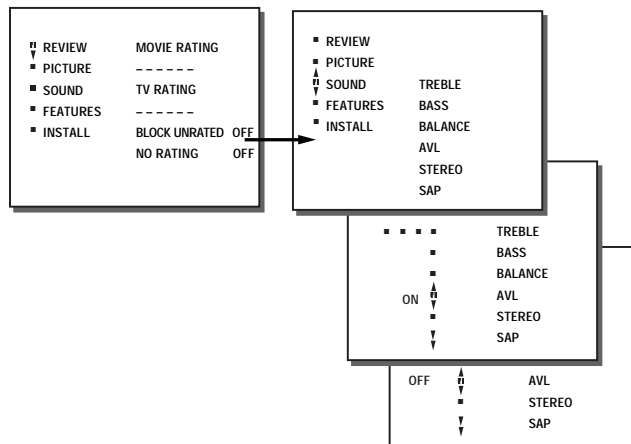

USING THE TV'S CHANNEL SURF CONTROL

A "list" or series of previously viewed channels can be selected with the SURF button on your remote control. With this feature you can easily switch between different TV programs that currently interest you. The SURF control allows you set up to ten channels in its quick viewing "list".

BEGIN

- 1 Press the CHANNEL (+) or (-) buttons (or the NUMBER buttons) to select a channel to add to the SURF list.
- 2 Press the SURF button on the remote. The onscreen display will read, "THE SURF LIST IS EMPTY, Press > to add".
- 3 Press the CURSOR RIGHT button to add the present channel to the SURF list.
- 4 Press the CURSOR LEFT button to delete the present channel from the SURF list.

Repeat steps 1 through 3 to add additional channels (up to 10) to the SURF list.



A/CH BUTTON

Your remote also has an A/CH (Alternate Channel) button. Pressing this button will toggle between the Current and previously viewed channel.

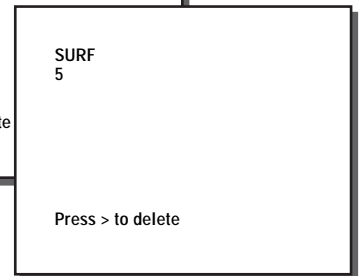
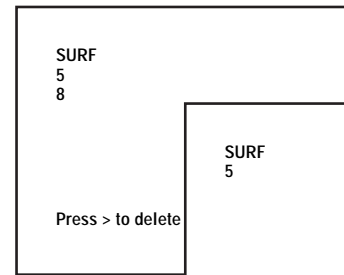
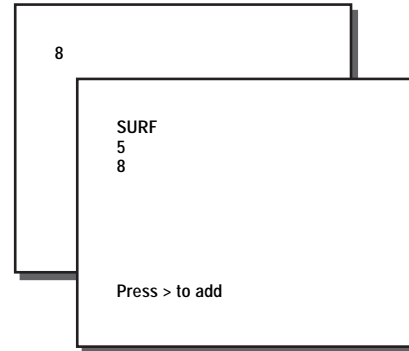
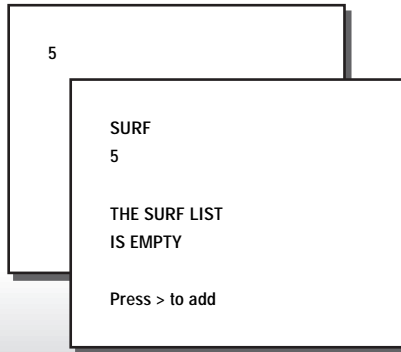
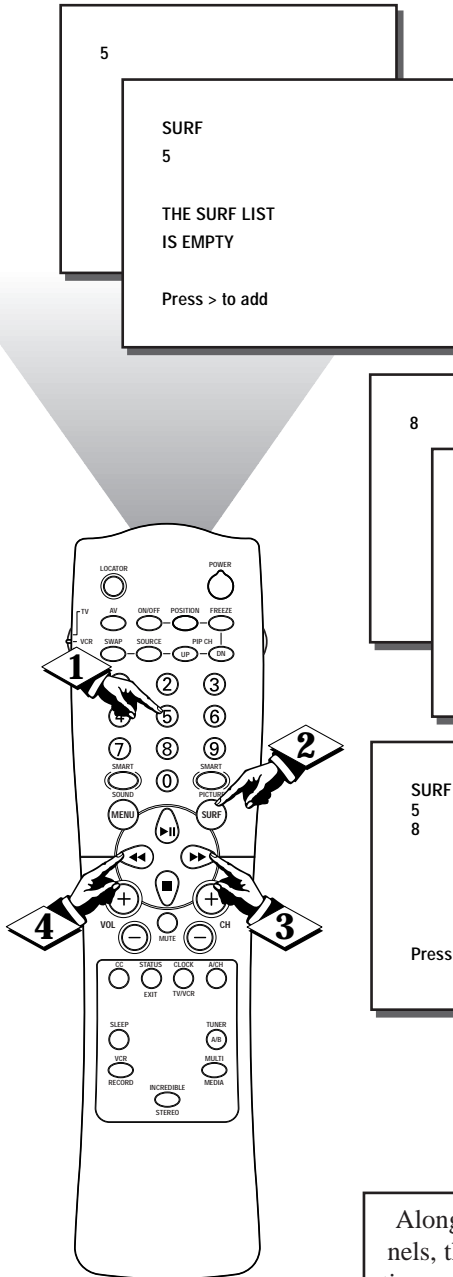
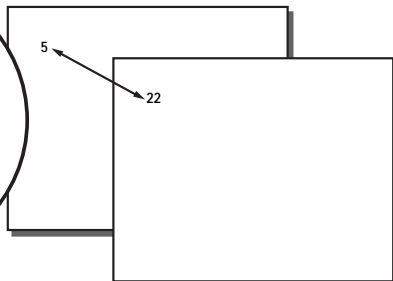
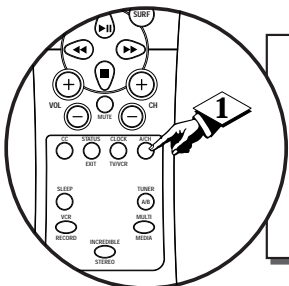

Along with regular programmed channels, the External Video Source connections can be added to the SURF list. This means the AV 1, AV 2, MM 1, and MM 2 channels can be added to your SURF list. Just tune to their channel and use the same procedure described on this page.

SETTING THE REMOTE CONTROL TO WORK WITH OTHER DEVICES



Your remote control is set to work your TV and many infrared remote (IR) control VCRs, Cable Boxes, Satellite Systems, DSS, DVD, etc. However, an easy onetime step may be necessary before the remote will work your VCR.

Try this initial check to see if going on to the following section is necessary.

BEGIN

1 Place the TV/VCR/ACC Mode Switch in the proper position.

2 Point the remote control at the device and press the POWER button.

3 Does the remote turn the device ON?

If YES, stop and try other function buttons on the remote. If they also work the device, then the remote is ready and no further steps are needed.

If NO, continue...

1 First look up a **THREE-DIGIT remote control number** for your brand of Device before going through the simple steps on the following page.

Find your Three-Digit Code on pages 42-43.

SMART HELP



Remember, if more than one number is listed, you may have to try more than the first Three-Digit code given in order to locate your Device's remote code.

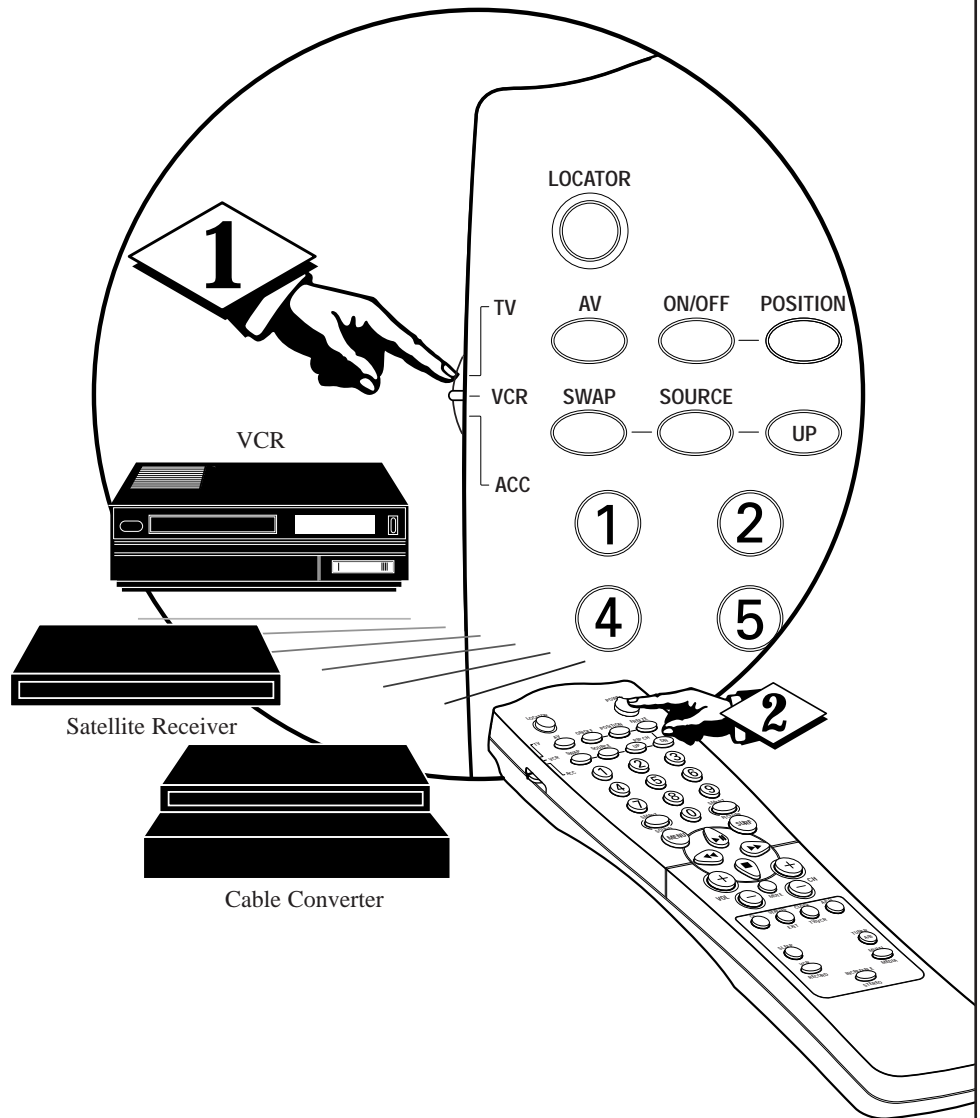

SETTING THE REMOTE CONTROL TO WORK WITH OTHER DEVICES

Direct Access Method

Now that you have looked up the three-digit Remote Code Number for your brand of device, you are ready to follow the four simple steps below.

Please read through steps 1-5 before beginning.

BEGIN

- 1 Place the TV/VCR/ACC Mode Switch in the proper position.
- 2 Press the VCR RECORD button on the remote control and release.
- 3 Press the SmartSound button on the remote within 30 seconds, then release.
- 4 Enter the THREE-DIGIT REMOTE CODE NUMBER for your desired device. The remote is now ready to send commands to the unit.
- 5 Point the remote at the Device. Press the POWER button on the remote to turn the unit ON.

STOP

SMART HELP

Remember, if this doesn't work the first time, repeat steps using the same remote code number.

After a second try and the remote does not operate your device, see if there is another three-digit code number (pages 42-43) listed for your device and repeat the steps above using the new number.

If after repeated attempts the code number method does not work your device, try the **SEARCH METHOD** on page 41.

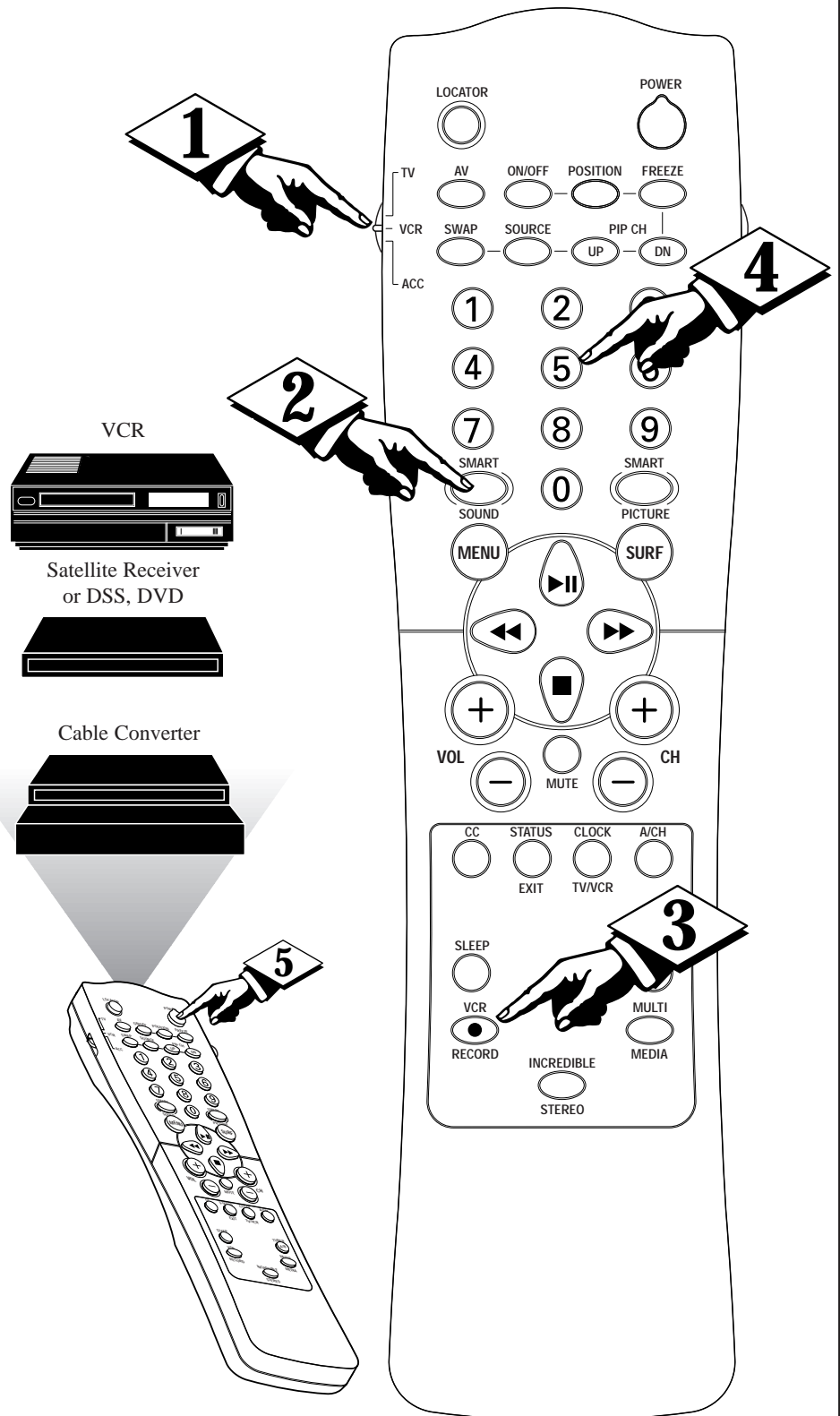

SETTING THE REMOTE CONTROL TO WORK WITH OTHER DEVICES



Search Method

Your TV remote can be set to work various external devices such as VCRs, Cable Boxes, Satellite Receivers, DBS, DVD, etc. by what is called the search method of remote control programming.

If the "Remote Code" number method shown on the previous page did not set your remote to work your external device, then follow the easy steps listed below.

Please read steps 1-4 before beginning.

(BEGIN)

- 1 Press the **POWER** button on the device you are attempting to program to turn ON.
- 2 Place the **TV/VCR/ACC Mode Switch** in the proper position.
- 3 Press the **VCR RECORD** and the **SMART SOUND** buttons simultaneously and hold them down.
- 4 The device will begin to change channels after the remote identifies the correct code. When the channels start to change release the VCR RECORD and SMART SOUND buttons. The remote should be ready to operate the device.



SMART HELP



This method can take up to two minutes to perform.

Don't let the device scan up more than five channels. If you do the remote may pass up the right code and another two minute search cycle will have to be repeated.

If no channel change happens within two minutes, repeat steps 1-4. Should a channel change still not occur, the remote will not work the desired device.

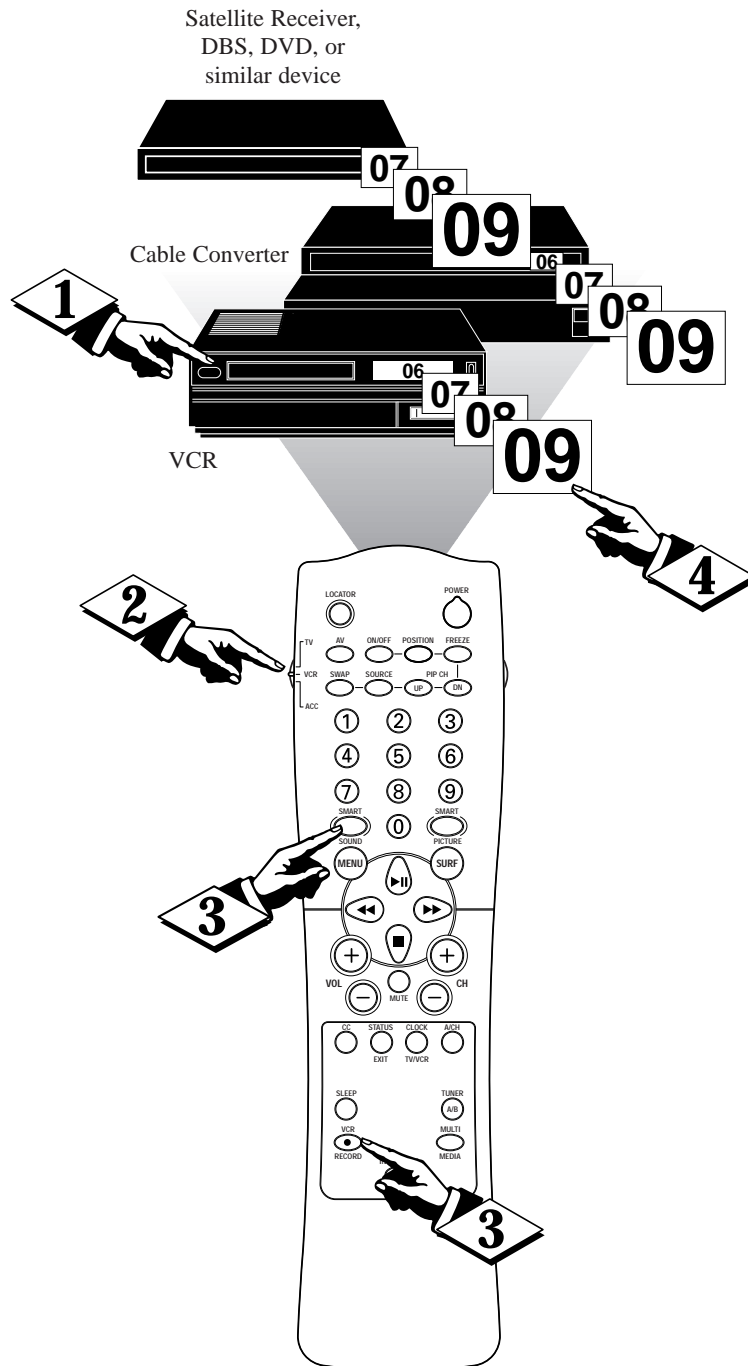



REMOTE CONTROL DIRECT ENTRY CODES

VCR	REMOTE CODE NO.
Admiral	.048
Advantz	.358
Adventure	.000
Aiko	.278
Aiwa	.000, 037, 307, 348, 352
Akai	.041, 049, 053, 061, 106, 315
Alba	.352
Amercian High	.035
Amstrad	.325, 332
Asha	.240
Audiovox	.037
Baird	.107
Beaumarck	.240
Bell & Howell	.104
Blaupunkt	.003, 006, 154
Brandt	.187, 320, 321
Broksonic	.121, 184, 211, 295, 361
Bush	.352
CCE	.072, 278
Calix	.037
Canon	.035
Caphart	.020
Carver	.081, 146
Citizen	.037, 278
Colt	.072
Combitach	.352
Craig	.037, 047, 072, 240, 271
Curtis Mathes	.035, 041, 060
Cybermax	.051, 240
Daewoo	.020, 045, 276
Daytron	.020
Denon	.042
Dynatech	.000
Electroponic	.037
Emerex	.032
Emerson	.000, 002, 036, 037, 043, 061 .068, 088, 121, 164, 208, 209, .211, 212, 278, 295, 361, 479
Ferguson	.107, 320, 321
Fisher	.047, 054, 066, 104
Fuji	.033, 035
Funai	.000
GE	.035, 060, 065, 202
Garrard	.000
Go Video	.232, 279, 432
Gold Star	.037, 038
Gradiente	.000, 406
Grundig	.003, 007, 195, 347
HI-Q	.047
Harley Davidson	.000
Harman/Kardon	.038, 075
Harwood	.068, 072
Headquarter	.046
Hinari	.004, 352
Hitachi	.000, 004, 041, 042, .065, 105, 168, 235
Ingersol	.004
JVC	.008, 041, 067, 208, 384, 486
Jensen	.041
KEC	.037, 278
KLH	.072
Kenwood	.038, 041, 067, 384
Kodak	.035, 037
LXI	.037
Lloyd's	.000, 206

VCR	REMOTE CODE NO.
Loewe	.004
Logik	.004, 072
MEI	.035
MGA	.043, 061
MGN Technology	.240
MTC	.000, 240
Magnavox	.000, 035, 081, 146, 181
Marta	.037
Matsui	.004, 348, 352
Matsushita	.035, 162, 454
Memmorex	.307
Memorex	.000, 035, 037, 039, 046, .047, 048, 104, 240, 266, 307
Metz	.003, 347
Minolta	.042, 105
Mitsubishi	.043, 061, 067, 075, 173, 443
Motorola	.035, 048
MultiTech	.000, 072
NAD	.058
NEC	.036, 040, 041, 067, 104
Nikko	.037
Nikon	.034, 253
Noblex	.240
Nordmende	.297, 320, 321
Okano	.346
Olympus	.035, 226
Optimus	.037, 048, 058, 104, .162, 432, 454
Optonica	.062
Orion	.004, 295, 348, 352, 479
Panasonic	.035, 077, 162, 225, .226, 378, 454
Penney	.035, 037, 038, 040, .042, 065, 105
Pentax	.042, 065, 105
Philco	.035
Philips	.035, 062, 081, 110, 403
Pilot	.037
Pioneer	.058, 067
Portland	.020
Profax	.322
Profitronic	.240
Protec	.072
Pulsar	.039, 051
Quarter	.046
Quartz	.046
Quasar	.035, 077, 162, 454
RCA	.042, 060, 065, 077, .105, 106, 149, 202
Radio Shack	.000, 037
Radix	.037
Randex	.037
Realistic	.000, 035, 037, 045, 047 .048, 062, 066, 104
Ricoh	.034, 253
Runco	.039
SEG	.322
SEI	.004
STS	.042
Saba	.297, 320, 321
Saisho	.004
Salora	.075
Samsung	.045, 051, 053, 240
Sanky	.039, 048
Sansui	.000, 041, 067, 271

VCR	REMOTE CODE NO.
Sanyo	.046, 047, 104, 240, 268
Saville	.352
Scott	.043, 045, 121, 164, 211, 212
Sears	.000, 035, 037, 042, 046, .047, 054, 066, 104, 105
Sharp	.046, 062
Shintom	.072
Shogun	.051, 240
Shoral	.004
Siemens	.003
Singer	.072
Sinudyne	.004
Sony	.000, 011, 022, 032, 033, .034, 035, 253, 275
Sunkel	.348
Sunpak	.253
Sylvania	.000, 035, 043, 081, 103, 110
Symphonic	.000
TMK	.036, 208, 240
Tatung	.041
Teac	.000, 041
Technics	.035, 162
Teknika	.000, 035, 037
Telefunken	.187, 320, 321
Tansal	.322
Thomas	.000
Thomson	.320
Toshiba	.043, 045, 066, 212, 366
Totavision	.037, 240
Towada	.322
Unitach	.240
Universum	.325
Vactor	.045
Vactor Research	.038, 040
Video Concepts	.040, 045, 061
Videosonic	.240
Wards	.000, 035, 042, 047, 048, 060, 062, .072, 081, 149, 161, 212, 240
XR-1000	.000, 035, 072
Yamaha	.038
Zenith	.000, 033, 034, 039

CABLE CONVERTOR	REMOTE CODE NO.
ABC	.001, 003, 007, 008, .011, 013, 014, 017
Aliegio	.153
Andover	.544
Antronix	.022
Archer	.022, 153
Balcor	.056
British Telecom	.105
Cable Star	.056
Cablatenna	.022
Cabletime	.161, 271, 377, 448
Cableview	.022
Century	.153
Citizen	.153
Clyde	.086
Colour Voice	.025, 031
Comtec	.274
Comtronics	.040
Contec	.019
Cryptovision	.600
Deceat	.423

USING THE REMOTE'S VCR BUTTONS

When using the TV remote with a VCR, first make certain it is set to control your VCR (by the REMOTE CODE or SEARCH method).

BEGIN

- 1 Set the TV/VCR/ACC mode switch to VCR on the remote.
- 2 Point the top of the remote toward the front of the VCR (remote sensor window) when pressing the buttons.



VCR SYSTEM SWITCH

Set in the VCR position to send remote commands to the VCR.

PLAY BUTTON

Press to begin playback of a video tape.

REWIND BUTTON

Press to rewind tapes. For some VCR's the STOP button may have to be pressed first, then REWIND. In playback mode press or press and hold the button to view the picture moving rapidly in reverse.

STOP BUTTON

Press to stop the motion of a tape in playback, rewind, fast forward, etc.

VCR RECORD BUTTON

Hold down the VCR/RECORD button and the PLAY button to begin a VCR recording.

SMART HELP

Remember, the VCR buttons on the remote will not operate your VCR if those features are not found on your VCR remote control.

Note: All VCR functions (particularly Search, Rewind, Fast Forward, etc.) will operate the same as with the original VCR remote control provided with the VCR.

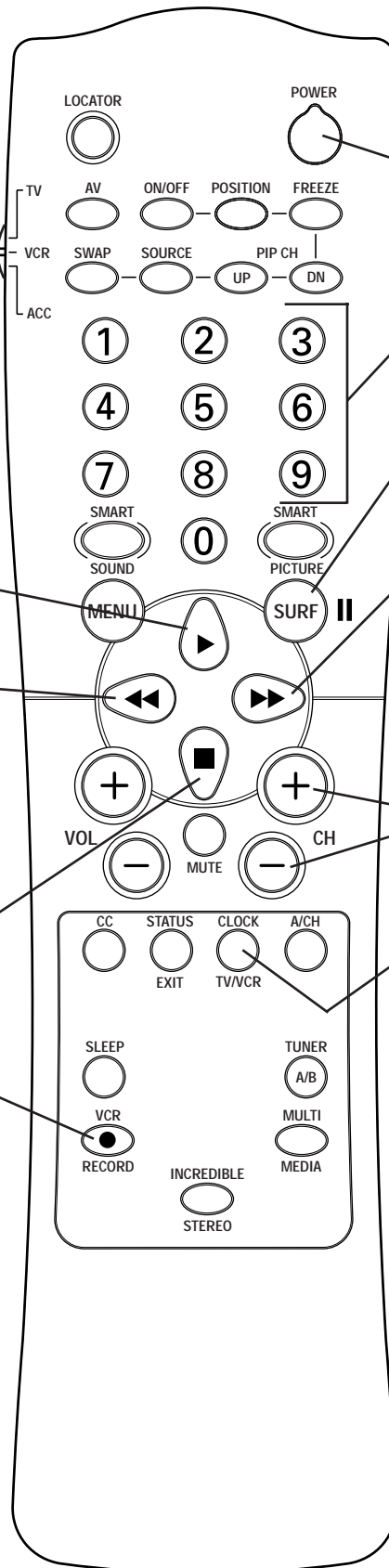

POWER BUTTON

Press to turn the VCR ON and OFF.

NUMBER BUTTON

Press buttons for direct VCR channel selections.

PAUSE BUTTON

Press to temporarily stop the tape during a playback or recording. Press again to release Pause.

FAST FORWARD BUTTON

Press to rapidly advance the tape. For some VCR's you may need to press the STOP button first, then the FAST FORWARD button. During playback, press or press and hold the button to view the picture moving rapidly in the forward direction.

CHANNEL + & - BUTTONS

Press to scan up or down through the VCR channel numbers.

TV/VCR BUTTON

Press to select the VCR position (VCR indicator on the front of the unit will light), to view the playback of a tape, to watch a program while recording it, or to watch a TV broadcast using the VCR CH +, - or Numbered buttons. Press again to place in the TV position (VCR indicator light will go off) or to view one program while recording another program.

USING THE PIP (PICTURE-IN-PICTURE) FEATURE



Hooking up PIP

Picture-In-Picture (PIP) is the showing of two pictures on the TV screen at the same time. (One main screen picture and one small inset picture - or PIP). For your ease and convenience this TV has two separate inputs (ANTenna A and PIP ANTenna B) for your home's Antenna and/or Cable TV system signal.

The ANT A input is primarily for the TV's main screen picture. The PIP ANT B input is provided as a second, dedicated source option for the TV's PIP "window" and its feature operations. The signal connected to the PIP ANT B input can be either a Split Signal Input (as described in the section on this page), or another type of external signal source (such as a satellite dish system, additional home antenna, video accessory, etc.).

See the following steps on how channels connected to the PIP ANT(enna) B Input can be shown and used within the PIP window:

BEGIN

- 1 **Connect your Antenna or Cable TV signal to the single 75 ohm INPUT plug on a two-way Signal Splitter (not supplied).**

Connect two lengths of RF Coaxial Cable (F-type connectors on both ends) to the two OUTPUT plugs on the two-way Signal Splitter.

- 2 **Connect the twin OUTPUT plugs on the Signal Splitter to the ANT A and PIP ANT B Inputs on the rear of the TV.**

SMART HELP



For other possible PIP connections see pages 49-50 for the "More PIP Connections" section.

If you need any accessories or parts to complete the described PIP connections, contact your dealer, or our Parts Information Center at:

1-800-851-8885

MAIN SCREEN PICTURE PIP INSET PICTURE

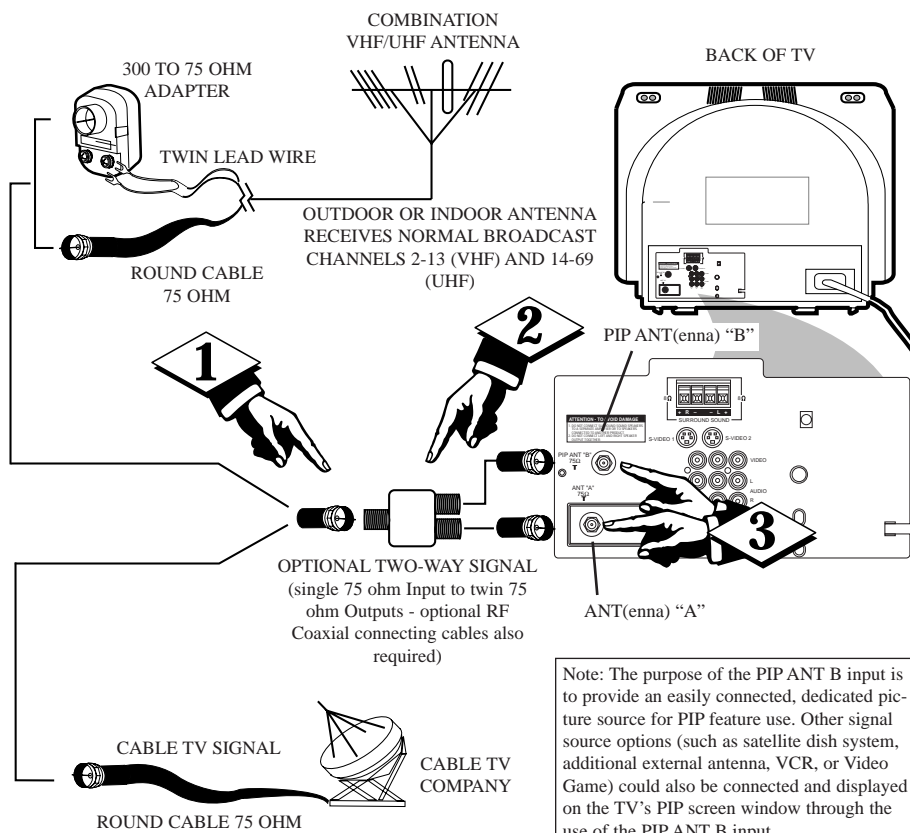

USING THE PIP (PICTURE-IN-PICTURE) FEATURE

CHOOSING THE PIP SOURCE

The picture for the PIP window can come through either the ANT/CABLE (PIP ANT B) or any of the external Audio/Video connections (AV 1, AV 2 or S-VIDEO 1, S-VIDEO 2) at the rear of the TV. PIP Source simply tells the TV which one of these sources it is to show in the PIP window.

BEGIN

- 1 Turn the TV and VCR (or other device hooked to the external A/V connections) ON.
- 2 Press the PIP ON/OFF button on the remote control. The PIP window should appear in the upper right hand portion of the screen.
- 2 Press the PIP SOURCE button on the remote to toggle between the different external connections.

The PIP SOURCE may come from the following:

AV 1, AV 2, S-VIDEO 1, S-VIDEO 2: for picture signal coming from the external Audio/Video jacks on the TV. (Must have an external device hooked up at these locations.)

ANTENNA/CABLE: for a picture signal coming from the PIP ANT B Input on the back of the TV.

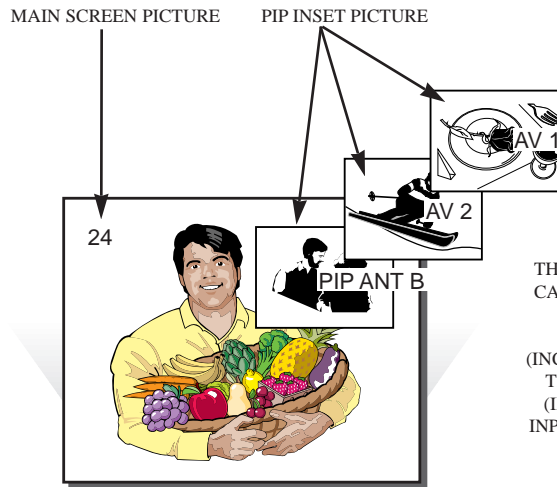

THE PIP SOURCE PICTURE CAN COME FROM THE PIP ANT B INPUT, THE AUDIO/VIDEO AV 1 (INCLUDING S-VIDEO 1), OR THE AUDIO/VIDEO AV 2 (INCLUDING S-VIDEO 2) INPUT JACKS AT THE REAR OF THE TV.

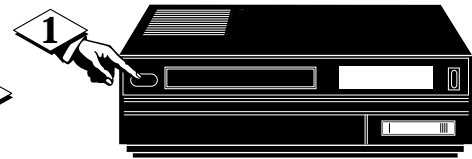
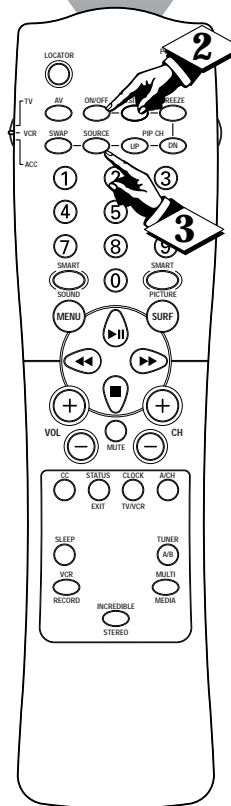

VCR
(OR SIMILAR DEVICE)

USING THE PIP (PICTURE-IN-PICTURE) FEATURE



REMOTE CONTROL BUTTONS

By using the PIP buttons on the remote control the PIP picture can be moved and swapped with the main screen. The PIP inset picture can also be frozen within the PIP window.

BEGIN

- 1 Press the **PIP ON/OFF button** to show the PIP picture. PIP appears in the upper right of the screen.
Press the **PIP ON/OFF button again** and the PIP picture is reduced in size.
Pressing the **ON/OFF button a third time** will remove the PIP picture from the screen.
- 2 Press the **PIP POSITION button** on the remote to move the PIP picture to any of the four corners.
- 3 Press the **PIP FREEZE button** on the remote to stop the action within the PIP window.
Press the **PIP FREEZE button again** to resume the normal viewing action.
- 4 Press the **PIP CH(annel) UP/DN buttons** on the remote to choose different channel or a different PIP source.
- 5 Press the **PIP SWAP button** to swap the main screen picture with the PIP inset picture.
Pressing the PIP swap button again will return the main picture to the screen.



1. PIP ON/OFF

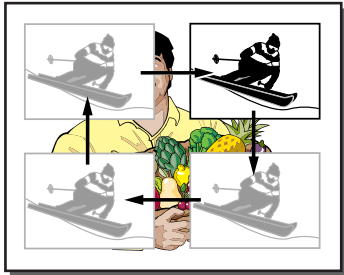

2. PIP POSITION

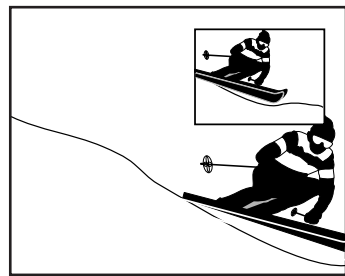

3. PIP FREEZE

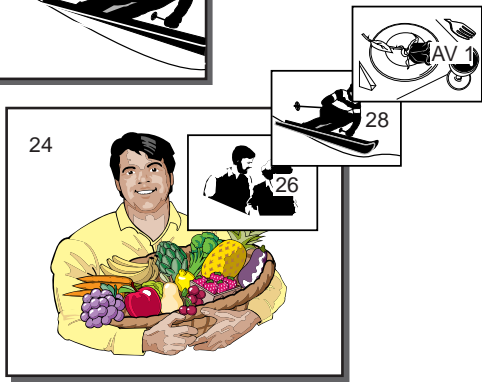

4. PIP CHANNEL UP/DN



5. PIP SWAP

ADJUSTING THE PIP COLOR AND TINT

The Picture-In-Picture (PIP) Color and Tint controls are used to make fine tune adjustments to the color settings for PIP (when it is shown on the TV screen).

BEGIN

- 1 Press the **MENU** button on the remote to show the onscreen menu.
- 2 Press the **CURSOR DOWN** button until the word **FEATURES** is highlighted.
- 3 Press the **CURSOR RIGHT** button and the menu will shift to the left to display the **TIMER** controls.
- 4 Press the **CURSOR DOWN** button to select the **PIP** menu.
- 5 Press the **CURSOR RIGHT** button again to shift the display to the **COLOR** and **TINT** adjustment bars.
- 6 Press the **CURSOR RIGHT** or the **CURSOR LEFT** buttons to adjust the **COLOR** and **TINT** bars to the desired levels.



SMART HELP

Remember, although there are separate **COLOR** and **TINT** controls for PIP, the adjustment levels for these controls depend on the TV's main picture. For example: If the main picture screen is showing a black and white picture, PIP would also be seen in black and white (even though the PIP picture source is in color).

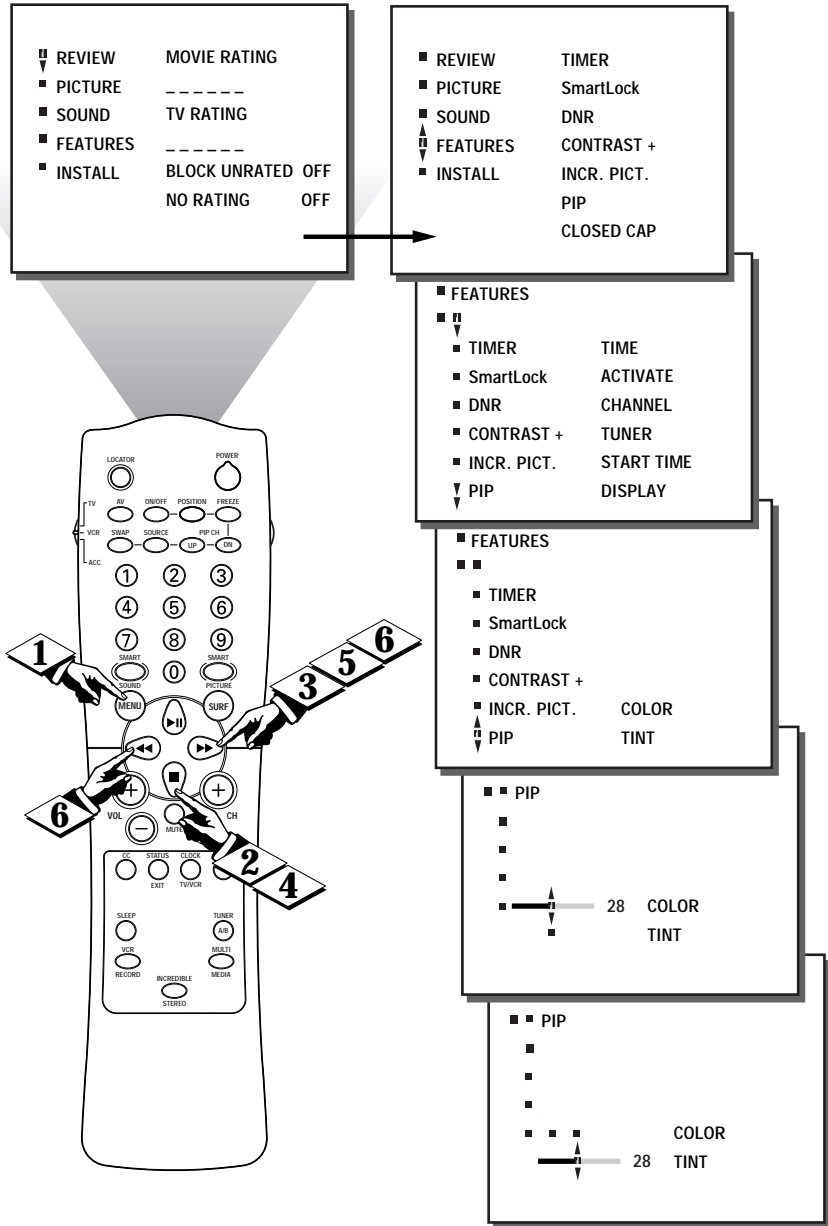

MORE PIP (PICTURE-IN-PICTURE) CONNECTIONS



PIP hookup with a Cable Box and VCR.

(BEGIN)

1 First use an optional signal splitter and connect the original cable TV signal to both the CABLE IN on the Cable Converter and the ANTENNA plug on the rear of the television.

2 Connect the CABLE OUT on the Converter to the ANT. IN on the VCR.

3 Connect the VIDEO OUT jack on the VCR to the VIDEO IN jack on the TV.

Also connect the AUDIO OUT (right and left) jacks from the VCR to the AUDIO IN jacks on the television.

STOP

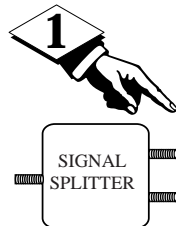
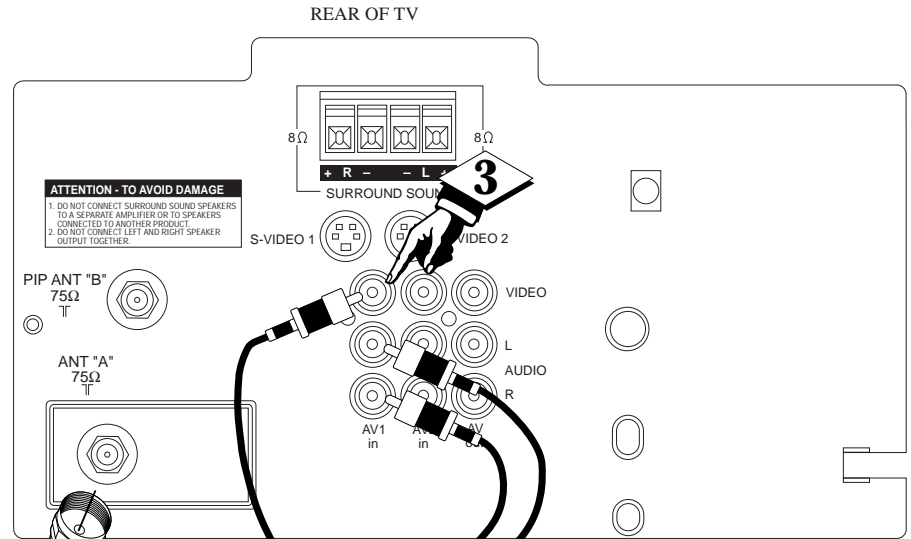

Contact the Parts Information Center at 1-800-851-8885 to order any optional accessories.

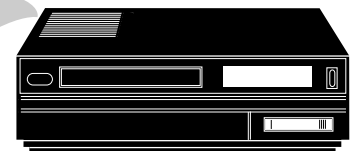
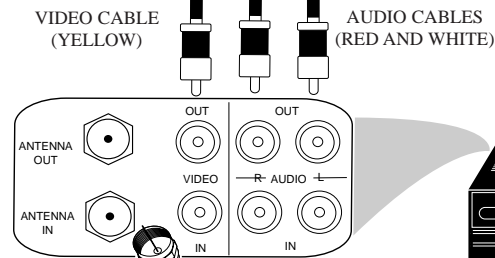

VCR

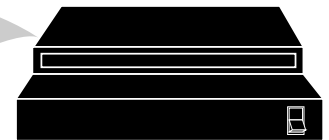
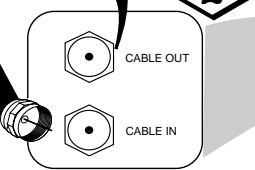

CABLE TV CONVERTER



MORE PIP (PICTURE-IN-PICTURE) CONNECTIONS

PIP hookup with a VCR and a Digital Video Disc Player (or similar device).

BEGIN

- 1 First connect the original cable TV signal or Antenna signal to the ANT IN jack on the back of the VCR.
- 2 Connect the ANT OUT jack on the rear of the VCR to the ANT IN jack on the rear of the Video Disc Player.
- 3 Connect the ANT OUT jack on the rear of the Video Disc Player to the ANT "A" input on the rear of the TV.
- 4 Connect the yellow Video Cable from the VIDEO OUT jack on the VCR to the VIDEO IN jack on the TV (labeled AV 1). Then, connect the red and white Audio Cables from the AUDIO OUT jacks on the VCR to the AUDIO IN jacks on the rear of the TV (labeled AUDIO L & R AV 1).
- 5 Connect the yellow Video Cable from the VIDEO OUT jack on the Video Disc Player to the VIDEO IN jack on the TV (labeled VIDEO AV 2). Then, connect the red and white Audio Cables from the AUDIO OUT jacks on the VCR to the AUDIO IN jacks on the rear of the TV (labeled AUDIO L & R AV 2).

Note: When selecting the PIP SOURCE, the VCR will appear on the AV 1 channel, and the Video Disc Player will appear on the AV 2 channel.

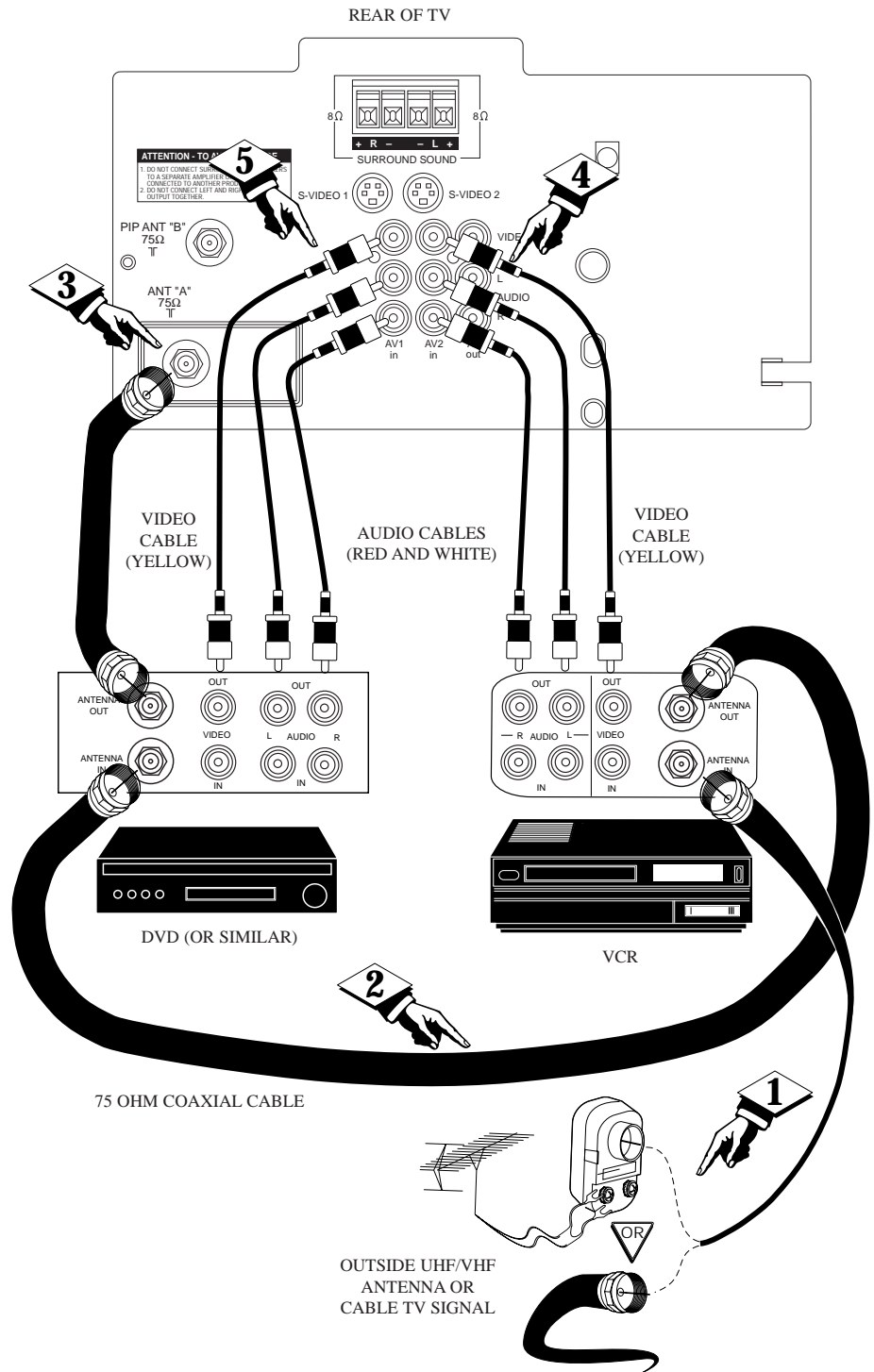



Please make these simple checks before calling for service. These tips can save you time and money since charges for TV installation and adjustment of customer controls are not covered under your warranty.

No Power

CAUTION: A video source (such as a video game, Compact Disc Interactive - CDI, or TV information channel) which shows a constant non-moving pattern on the TV screen, can cause picture tube damage. When your TV is continuously used with such a source the pattern of the non-moving portion of the game (CDI, etc.) could leave an image permanently on the picture tube. When not in use, turn the video source OFF. Regularly alternate the use of such video sources with normal TV viewing.

- Check the TV power cord. Unplug the TV, wait 10 seconds, then reinsert plug into outlet and push POWER button again.
- Check that outlet is not on a wall switch. Be sure fuse is not blown on AC Power strip.
- Check to be sure the system mode switch (TV/VCR/ACC) is in the correct position when using the remote control to power the set ON.

No Picture

- Check antenna connections. Are they properly secured to the TV's ANT/CABLE plug ?
- Check the TUNER control for CABLE or ANTENNA setting.
- Press the AV button on the remote to make sure the correct signal source is selected. (AV 1, AV 2, or MM 1, MM 2)

No Sound

- Check the VOLUME buttons.
- Check the MUTE button on the remote control.
- Check the SPEAKER onscreen control. OFF position will eliminate sound at the set.
- If attempting auxiliary equipment hook-ups, check audio jack connections.
- (If Applicable) Check Audio Receiver for correct operating mode.

Remote Does Not Work

- Check TV/VCR/ACC "System" switch on the remote. Move the switch to the TV position to operate the television.
- Check batteries. Replace with AA Heavy Duty (Zinc Chloride) or Alkaline batteries if necessary.
- Clean the remote and the remote sensor window on the TV.
- Check the TV power cord. Unplug the TV, wait 10 seconds, then reinsert plug into outlet and push POWER button again. Be sure fuse is not blown on AC Power strip.
- Check to be sure TV outlet is not on a wall switch.

TV Displays Wrong Channel or No Channels Above 13

- Repeat channel selection.
- Add desired channel numbers (CHANNEL control) into TV memory.
- Check to be sure the TUNER control is set to the CABLE option.

Cleaning and Care

- To avoid possible shock hazard be sure the TV is unplugged from the electrical outlet before cleaning.
- When cleaning the TV screen take care not to scratch or damage the screen surface (avoid wearing jewelry or using anything abrasive). Wipe the front screen with a clean cloth dampened with water. Use even, easy, vertical strokes when cleaning.
- Gently wipe the cabinet surfaces with a clean cloth or sponge dampened in a solution of cool clear water. Use a clean dry cloth to dry the wiped surfaces.
- Never use thinners, insecticide sprays, or other chemicals on or near the cabinet, as they might cause permanent marring of the cabinet finish.



GLOSSARY TO TELEVISION TERMS

Alternate Channel • When using the A/CH button on the remote control, toggles between the last two channels viewed.

Auto Programming • When activated, this feature automatically scans for all available channels. These channels come from regular antenna or cable signals (only active, broadcast stations) and they are stored into the TV's memory.

Channel Edit • Add or delete channels from the sequential tuning cycle to develop a customized list of channels you want to watch. Editing makes it easy to limit the number of channels when scanning the Channel up and down buttons or expand the number of channels available to suit your own preference.

Coaxial Cable • A single solid antenna wire normally matched with a metal plug (F-type) end connector that screws (or pushes) directly onto a 75 Ohm input found on the Television or VCR.

Closed Caption • Broadcast standard which allows you to read the voice content of television programs on the TV screen. Designed to help the hearing impaired this feature uses onscreen "text boxes" to show dialogue and conversations while the TV program is in progress.

Direct Audio/Video Inputs • Located on the rear of the TV these connectors (RCA phono type plug) are used for the input of audio and video signals. Designed for use with VCRs (or other accessories) in order to receive higher picture resolution and offer sound connection options.

Identify • Method by which a remote control searches and finds an operating code for another product (such as a VCR or Cable Converter). Once the code has been "identified" then the TV remote can operate and send commands to the other product.

Onscreen Displays (OSD) • Refers to the wording or messages generated by the television (or VCR) to help the user with specific feature controls (color adjustment, programming, etc.).

Menu • An onscreen listing of feature controls shown on the Television screen that are made available for user adjustments.

Multichannel Television Sound (MTS) • The broadcast standard that allows for stereo sound to be transmitted with the TV picture.

Programming • The procedure of adding or deleting channel numbers into the Television's memory circuits. In this way the Television "remembers" only the locally available or desired channel numbers and skips over any unwanted channel numbers.

Remote Sensor Window • A window or opening found on the Television control panel through which infrared remote control command signals are received.

Setup Mode • Automatic feature control settings made by the TV. Designed for first time setup and use. Settings for signal connections (antenna or cable TV), plus channel program memory are held in the TV's memory (even if the set is unplugged and moved to a new location.)

Second Audio Program (SAP) • Another or additional audio channel provided for in the Multichannel Television Sound (MTS) broadcast standard. The most frequently proposed use for SAP is the simultaneous bilingual broadcast of TV program material.

SmartClock • An accurate digital clock that's always right. By monitoring the vertical blanking interval of PBS broadcasts, TV's equipped with SmartClock can automatically set the right time of day and maintain it through brown-outs, power failures, and even daylight savings time adjustments.

SmartLock • Prevents young children from accessing particular broadcast channels (or using audio/video inputs) by electronically locking them out. Undesired channels are blocked out by entering a unique four-number code, which you choose when programming the feature. Blocked-out channels are just as quickly restored with the same process.

Status/Exit • Allows the user to quickly confirm what channel number is currently being viewed. Status/Exit can also be used to clear the Television of on screen displays or information (rather than waiting for the displays to "time out" or automatically disappear from the screen).

Twin Lead Wire • The more commonly used name for the two strand 300 Ohm antenna wire used with many indoor and outdoor antenna systems. In many cases this type of antenna wire requires an additional adapter (or balun) in order to connect to the 75 Ohm Input terminals designed into the more recent Televisions and VCRs.

Two Tuner PIP • This TV has two separate tuners (and two separate tuner inputs) which allow you to watch one show with one tuner, while scanning other channel with the second tuner in the PIP window.



Accessories/Optional	30-33, 49-50, *Q/U-1	Picture Controls	6
Adapter Connector	45, 49-50, *Q/U-1	PIP (Picture-In-Picture) Connections	45, 49-50
Add/Delete Channels	*Q/U-3	PIP Picture Source Control	46
Alternate Channel	38	PIP Control with the TV Remote	47
Audio/Video Jackpanel	30-33, 45, 49-50	PIP Color and Tint Adjustments	48
AVL (Automatic Volume Leveler)	37	Precautions/Safety	3, 56, *Q/U-1
Balance Control	27	Programming Channels	*Q/U-3
Bass Control	27	Remote Control	34-44, *Q/U-2
Battery Installation	*Q/U-2	Remote Control Direct Entry Code List	42-43
Cable Converter Direct Entry Code List	42-43	Remote Control with Accessory Equipment	39-44
Cable TV Connections/Settings	32-33, *Q/U-3	REmote Locator Feature	34-35
Channel (Name) Display	*Q/U-4	Requesting Service	54-56
Channel Memory	*Q/U-3	RF Coaxial Cable	33, 45, 49-50, *Q/U-1
Closed Captioning	25	Satellite Receiver Direct Entry Code List	43
Contrast + (Black Stretch) Control	23	Safety/Precautions	3, 56, *Q/U-1
Controls/TV	*Q/U-2	Second Audio Program	28
Controls/Remote	34-44, *Q/U-2	Sensor Remote	*Q/U-2
Dynamic Noise Reduction (Video Noise)	23	Set Up/First Time Use	*Q/U-1, 2, 3, 4
Factory Service Locations	54-55	Sleep Timer	26
Features	5	SmartLock Control	13-22
Glossary TV Terms	52	SmartPicture Control	36
Incredible Picture Control	24	SmartSound Control	37
Incredible Stereo Control	29	Status Button	*Q/U-2
Inputs/Audio and Video	30, 32-33, 45, 49-50	Stereo	28
Language Option	*Q/U-3	Surf	38
Memory/Program Channels	*Q/U-3	Tips for Service	51, 54-56
Menu Button	*Q/U-2	Treble Control	27
Minus(-)/Plus (+) Buttons	*Q/U-2	Tuner Control	*Q/U-3
Onscreen TV Clock	7	TV Speaker Control	30
On Timer Channel Control	9	VCR Buttons	44, Q/U-2
On Timer Control	8	VCR/TV Connections	32-33, 49-50, *Q/U-1
On Timer Display	12	Volume Bar Control	29
On Timer Start Up Control	11	Warranty	56
On Timer Tuner Control	10		

* Information contained in Quick-Use (Q/U) Guide-page listed.

Philips Consumer Electronics Company Factory Service Center Locations

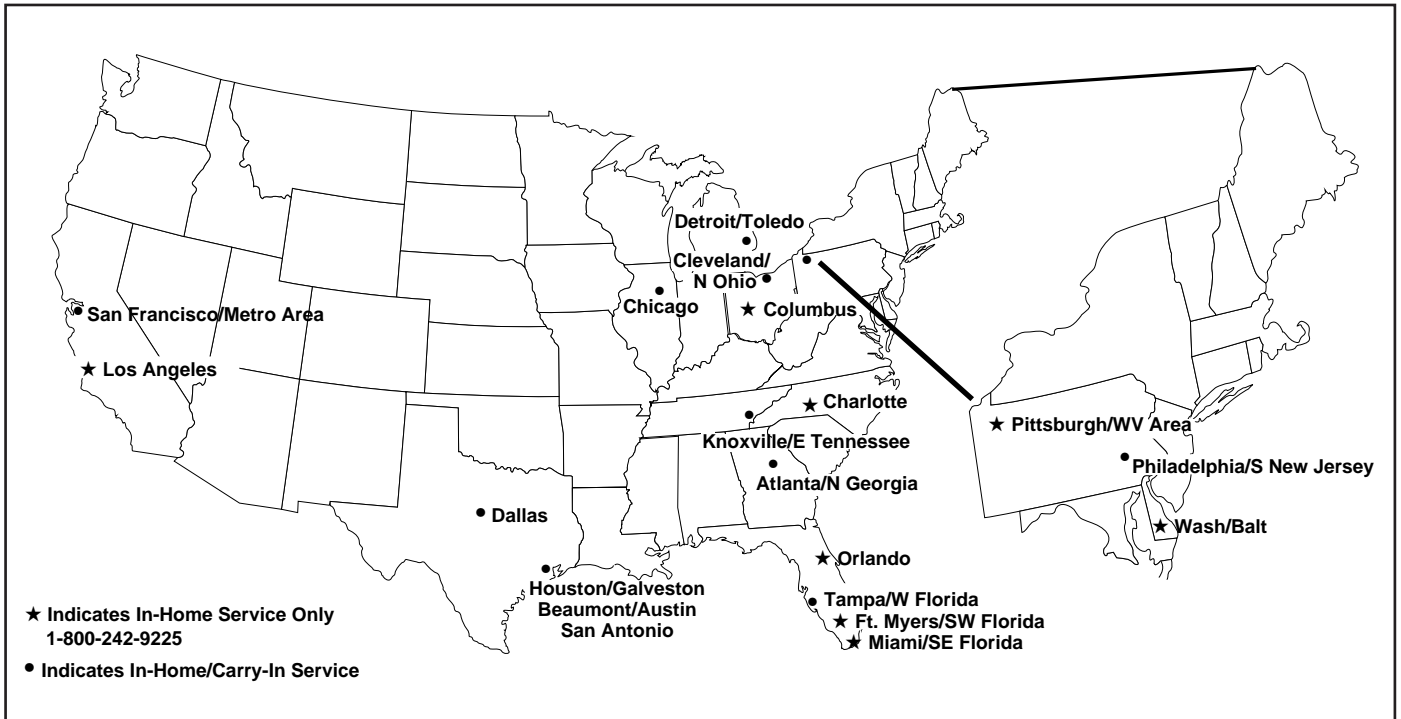

NOTE: If you reside in one of our Philips Factory Service Branch areas (see directory on back), you can contact the nearest Service Branch to obtain efficient and expedient repair for your product. If your product is In-Warranty, you should have proof-of-purchase to ensure No Charge Service. For Out-of-Warranty service, call the location nearest you.

NOTA: Si vous résidez dans une des régions desservies par une succursale de service après vente du fabricant Philips (voir liste ci-dessous), vous pourrez contacter la branche de service après vente la plus près de chez vous pour obtenir un service après vente rapide et efficace. Si le produit est sous garantie, il suffira de présenter une preuve d'achat pour bénéficier d'un service sans frais. Pour les produits non couverts par la garantie, contactez le centre le plus près de chez vous.

NOTA: Si Ud. reside en una de nuestras zonas para sucursales Philips de servicio al de fábrica (ver directorio más abajo), Ud. puede comunicarse con la sucursal de servicio más cercana para obtener una reparación oportuna y eficaz de su producto. Si su producto está todavía bajo garantía, Ud. debe presentar comprobante de compra para no ocasionar ningunos cargos por servicio. Para servicio después del vencimiento de la garantía, llame al lugar más cercano de los abajo indicados.

In Canada

How you can obtain efficient and expedient carry-in, mail-in, or in-home service for your product
Please contact Philips at
1-800-661-6162 (French speaking)
1-800-363-7278 (English speaking)

Au Canada

Comment obtenir le service après-vente pour les produits apportés ou envoyés par la poste à notre centre de service ou le service à domicile
Veuillez contacter philips à:
1-800-661-6162 (Francophone)
1-800-363-7278

En el Canadá

Cómo recibir servicio eficiente para su producto, en persona, por correo o a domicilio
Favor de comunicarse con Philips al:
1-800-661-6162 (francófono)
1-800-363-7278 (anglófono)

QUALITY SERVICE IS AS CLOSE AS YOUR TELEPHONE! SIMPLY LOOK OVER THE LIST BELOW FOR THE NUMBER OF A FACTORY SERVICE CENTER NEAR YOU. YOUR PRODUCT WILL RECEIVE EFFICIENT AND EXPEDIENT CARRY-IN, MAIL-IN, OR IN-HOME SERVICE, AND YOU WILL RECEIVE PEACE OF MIND, KNOWING YOUR PRODUCT IS BEING GIVEN THE EXPERT ATTENTION OF PHILIPS' FACTORY SERVICE. AND, IF THE PHONE NUMBER LISTED FOR YOUR AREA IS LONG DISTANCE, CALL 1-800-242-9225 FOR FACTORY SERVICE.

COMMENT OBTENIR NOTRE SERVICE APRÈS VENTE RAPIDE ET EFFICACE SOIT PAR COURRIER, À DOMICILE, OU EN SE PRÉSENTANT À UN CENTRE DE SERVICE PHILIPS. PLUS DE 600 CENTRES DE RÉCEPTION DE PRODUITS À RÉPARER À TRAVERS LE PAYS: CONTACTER LE CENTRE DE SERVICE AUX CONSOMMATEURS LE PLUS PROCHE POUR SAVOIR L'EMPLACEMENT DE CES DÉPÔTS DANS UN RAYON DE 50 À 75 MILES (80 KM À 120 KM) DU CENTRE DE SERVICE LOCAL.

CÓMO OBTENER UN SERVICIO OPORTUNO Y EFICIENTE POR CORREO, EN CASA O EN PERSONA PARA SU PRODUCTO A TRAVÉS DE UN CENTRO PHILIPS DE SERVICIO. MAS DE 600 SITIOS POR TODO EL PAIS PARA LA RECEPCION DE PRODUCTOS NECESITADOS DE REPARACIONES: COMUNICARSE CON EL CENTRO DE SERVICIO DE FABRICA MAS CERCAÑO PARA ESTOS LUGARES DENTRO DE UN RADIO DE 80 A 120 KM (50 A 75 MILLAS) DEL CENTRO DE SERVICIO LOCAL.

GEORGIA

Philips Factory Service of Georgia
200 N. Cobb Pkwy., Suite 120
Marietta, GA 30062
(770) 795-0085

FLORIDA

Philips Factory Service of Florida
1911 US Highway 301 North
Tampa, FL 33619
(813) 621-8181

WESTERN U.S.A.

Philips Factory Service Western Region
681 East Brokaw Rd.
San Jose, CA 95112
(408) 436-8566

TEXAS

Philips Factory Service of Texas
1110 N. Post Oak Rd., Suite 100
Houston, TX 77055
(713) 682-3990

CENTRAL U.S.A.

Philips Factory Service Central US
950 Keynote Circle
Brooklyn Heights, OH 44131
(216) 741-3334

MICHIGAN

Philips Factory Service of Michigan
25173 Dequindre
Madison Heights, MI 48071
(248) 544-2110

DALLAS AREA

Philips Factory Service of Dallas
415 N. Main Street, #107
Euless, TX 76040
(713) 682-3990

ILLINOIS

Philips Factory Service of Illinois
1279 W. Hamilton Pkwy.
Itasca, IL 60143
(630) 775-0990

TENNESSEE

Philips Factory Service of East Tennessee
6700 D Papermill Rd.
Knoxville, TN 37919
(423) 584-6614

MID-ATLANTIC

Philips Factory Service Mid-Atlantic
352 Dunks Ferry Rd.
Bensalem, PA 19020
(215) 638-7500

LIMITED WARRANTY

COLOR TELEVISION

90 Days Free Labor

One Year Free Replacement of Parts (Two Years Free Replacement on Color Picture Tube)

This product can be repaired in-home.

WHO IS COVERED?

You must have proof of purchase to receive warranty service. A sales receipt or other document showing that you purchased the product is considered proof of purchase.

WHAT IS COVERED?

Warranty coverage begins the day you buy your product. *For 90 days thereafter*, all parts will be repaired or replaced free, and labor is free. From 90 days to one year from the day of purchase, all parts will be repaired or replaced free, but you pay for all labor charges. From one to two years from the day of purchase, you pay for the replacement or repair of all parts except the picture tube, and for all labor charges. After two years from the day of purchase, you pay for the replacement or repair of all parts, and for all labor charges.

All parts, including repaired and replaced parts, are covered only for the original warranty period. When the warranty on the product expires, the warranty on all replaced and repaired parts also expires.

WHAT IS EXCLUDED?

Your warranty does not cover:

- labor charges for installation or setup of the product, adjustment of customer controls on the product, and installation or repair of antenna systems outside of the product.
- product repair and/or part replacement because of misuse, accident, unauthorized repair or other cause not within the control of Philips Consumer Electronics Company.
- reception problems caused by signal conditions or cable or antenna systems outside the unit.
- a product that requires modification or adaptation to enable it to operate in any country other than the country for which it was designed, manufactured, approved and/or authorized, or repair of products damaged by these modifications.
- incidental or consequential damages resulting from the product. (Some states do not allow the exclusion of incidental or consequential damages, so the above exclusion may not apply to you. This includes, but is not limited to, prerecorded material, whether copyrighted or not copyrighted.)
- a product used for commercial or institutional purposes.

WHERE IS SERVICE AVAILABLE?

Warranty service is available in all countries where the product is officially distributed by Philips Consumer Electronics Company. In countries where Philips Consumer Electronics Company does not distribute the product, the local Philips service organization will attempt to provide service (although there may be a delay if the appropriate spare parts and technical manual(s) are not readily available).

MAKE SURE YOU KEEP...

Please keep your sales receipt or other document showing proof of purchase. Attach it to this owner's manual and keep both nearby. Also keep the original box and packing material in case you need to return your product.

BEFORE REQUESTING SERVICE...

Please check your owner's manual before requesting service. Adjustments of the controls discussed there may save you a service call.

TO GET WARRANTY SERVICE IN U.S.A., PUERTO RICO OR U.S. VIRGIN ISLANDS...

Contact a Philips factory service center (see enclosed list) or authorized service center to arrange repair.

(In U.S.A., Puerto Rico and U.S. Virgin Islands, all implied warranties, including implied warranties of merchantability and fitness for a particular purpose, are limited in duration to the duration of this express warranty. But, because some states do not allow limitations on how long an implied warranty may last, this limitation may not apply to you.)

TO GET WARRANTY SERVICE IN CANADA...

Please contact Philips at:

1-800-894-5463
1-800-363-7278

(In Canada, this warranty is given in lieu of all other warranties. No other warranties are expressed or implied, including any implied warranties of merchantability or fitness for a particular purpose. Philips is not liable under any circumstances for any direct, indirect, special, incidental or consequential damages, howsoever incurred, even if notified of the possibility of such damages.)

REMEMBER...

Please record the model and serial numbers found on the product below. Also, please fill out and mail your warranty registration card promptly. It will be easier for us to notify you if necessary.

MODEL # _____

SERIAL # _____

This warranty gives you specific legal rights. You may have other rights which vary from state/province to state/province.

Philips Consumer Electronics Company, P.O. Box 2976, Longview, Texas 75606, (903) 242-4800

Free Manuals Download Website

<http://myh66.com>

<http://usermanuals.us>

<http://www.somanuals.com>

<http://www.4manuals.cc>

<http://www.manual-lib.com>

<http://www.404manual.com>

<http://www.luxmanual.com>

<http://aubethermostatmanual.com>

Golf course search by state

<http://golfingnear.com>

Email search by domain

<http://emailbydomain.com>

Auto manuals search

<http://auto.somanuals.com>

TV manuals search

<http://tv.somanuals.com>